

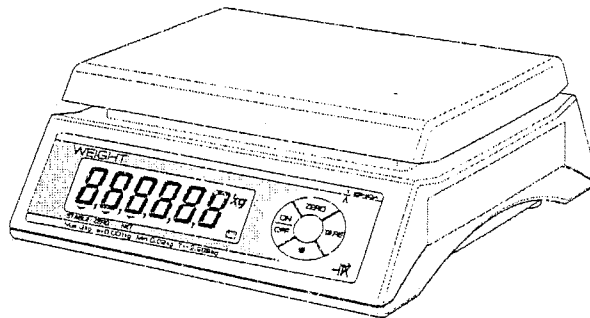

IPC Series (Asia)

Service Manual

The First Edition



WARNING



- Read this manual thoroughly and do not perform installation, operation, maintenance, or inspection unless you fully understand all of the contents.
- Keep this manual in a safe place where you can refer to it easily while installing, operating, and carrying out maintenance or inspections.

This manual is for use by service personnel of our company or qualified to perform maintenance services for this machine. Use by anyone except the above personnel is not permitted.



OUTLINE

- **Purpose of this manual**
This manual is edited for the authorized servicing personnel and used when carrying out services and maintenance of the machine.
- **Relative manual**
Refer to the operation manual for usual operations.
- **Symbols used in this manual**

1. Warning symbols

Symbol	Meaning
 DANGER	Indicates information that, if not avoided, is likely to result in loss of life or serious injury.
 WARNING	Indicates information that, if not avoided, may result in loss of life or serious injury.
 CAUTION	Indicates information that, if not avoided, could result in relatively serious or minor injury, damage to the machine or faulty operation.

2. Explanatory symbols

Symbol	Meaning
 NOTE	Indicates information to call or emphasize for attention to the note.
 REFERENCE	Indicates the reference page.
 INFORMATION	Indicates information to help understanding.

- **Readers of this manual**
This manual is edited for the servicing personnel. Use by other personnel is not permitted.
- **Note**
This manual may be revised in accordance with modification when made in the machine.
All rights are reserved. Copying any part of this manual is prohibited without our permission.

Contents

Chapter 1. Product Overview	3
1.1 Product Overview.....	3
1.2 Standard Specifications	3
1.3 Appearance.....	4
1.4 Operation Panel	5
1.5 Outer Dimensions	6
Chapter 2 Test Mode	7
2.1 Operation	7
2.1.1 Test Mode Flow	7
2.1.2 Key Functions (when setting value).....	8
2.1.3 Starting Test Mode.....	8
2.1.4 Ending Test Mode.....	8
2.1.5 Memory Switch	8
2.1.6 C1 Mode – Country No. Setting.....	9
2.1.7 C2 Mode – Scale No. and Decimal point Setting	10
2.1.8 C3 Mode – Span Adjustment.....	11
2.1.9 F Mode – Setting measuring conditions and E2ROM clear.....	12
2.1.10 Error No. List.....	13
Chapter 3 Hardware Configuration.....	14
3.1 Mechanisms.....	14
3.1.1 Small Size (3kg, 6kg).....	14
3.1.2 Large Size (15kg ~30kg).....	16
3.2 Electric Concerns.....	18
3.2.1 Block Diagram.....	18
3.2.2 Board PS-005	18
Chapter 4 Maintenance.....	20
4.1 Disassembly Procedure (Small Size: 3kg • 6kg).....	20
4.1.1 Base Replacement.....	20
4.1.2 Board Replacement	21
4.1.3 Load Cell Replacement	22
4.2 Assembly Procedure (Large Size: 15kg • 30kg)	24
4.2.1 Base Replacement.....	24
4.2.2 Board Replacement	25
4.2.3 Load Cell Replacement	26
4.3 Troubleshooting	28

Chapter 1. Product Overview

1.1 Product Overview

- The IPC Series is a digital scale which can be operated with two batteries.
- The large LCD with 25mm height is provided for the display.

1.2 Standard Specifications

Item	Description			
	Small size		Large size	
Type name	IPC 3kg	IPC 6kg	IPC 15kg	IPC 30kg
Weighing capacity	3kg/1g	6kg/2g	15kg/5g	30kg/10g
	Single range	Single range	Single range	Single range
Scale unit	0.001kg	0.002kg	0.005kg	0.01kg
	3.000kg/0.001kg	6.000kg/0.002kg	15.000kg/0.005kg	30.00kg/0.01kg
Accuracy	1/3000			
Weigh platter size	200mm(L)×230mm(W)		293mm(L)×280mm(W)	
Display	LCD type 6 digits (7 segments) Height : 25mm			
Environment condition	Ambient temperature: -5°C to +40°C Relative humidity: 80%RH (Max.), no condensation			
Power source	Two D-sized dry batteries or AC adaptor [Battery duration] Two alkaline D-sized batteries (Approximately 500 hours)			
Current consumption	Max. 25mA			
Auto power off	Select: 60 minutes (default), 20 minutes or non Auto power off			
Weight (excl. battery)	2.0kg		3.2kg	
Option	AC adaptor (Dealer Option) -Output voltage - 3.2 to 6.0VDC (current load at 25mA, or at IPC connection) (caution) 1. Output voltage must not exceed 6.0V even if power supply voltage is at +10%. 2. Output voltage exceeds 3.2V even if power supply voltage is at -15%. - Generally, AC adaptor output voltage varies with load current. Confirm output voltage with a 25mA load current (IPC current) - Output plug configuration/polarity - Configuration Specification EIAJ RC-5320-2 - Polarity Center Plus			

1.3 Appearance

Front view

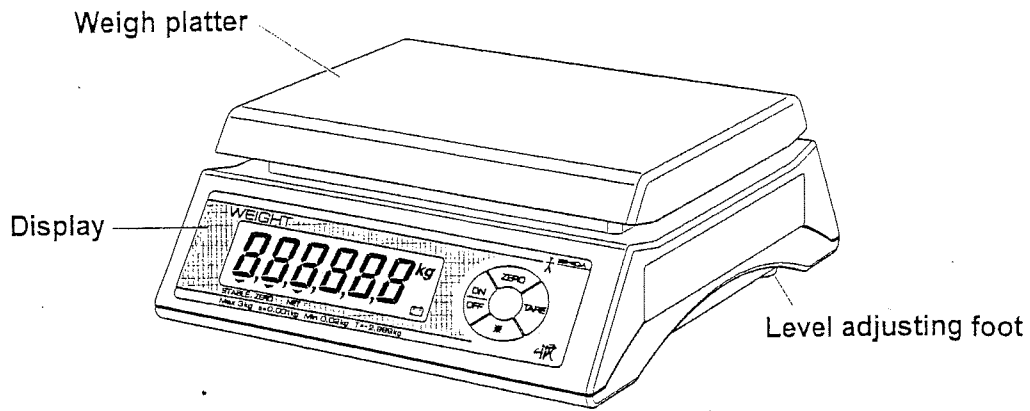

Rear view

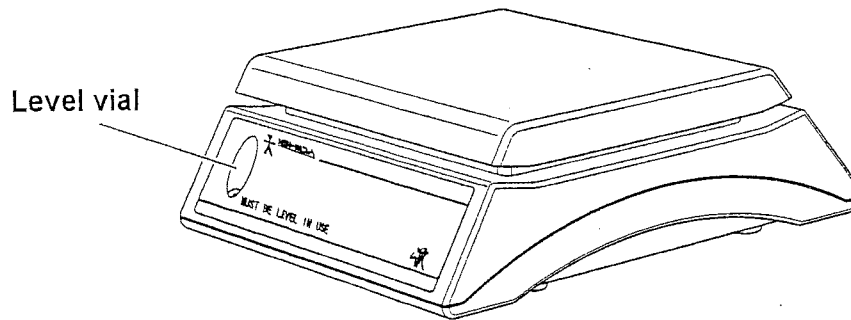

Bottom view

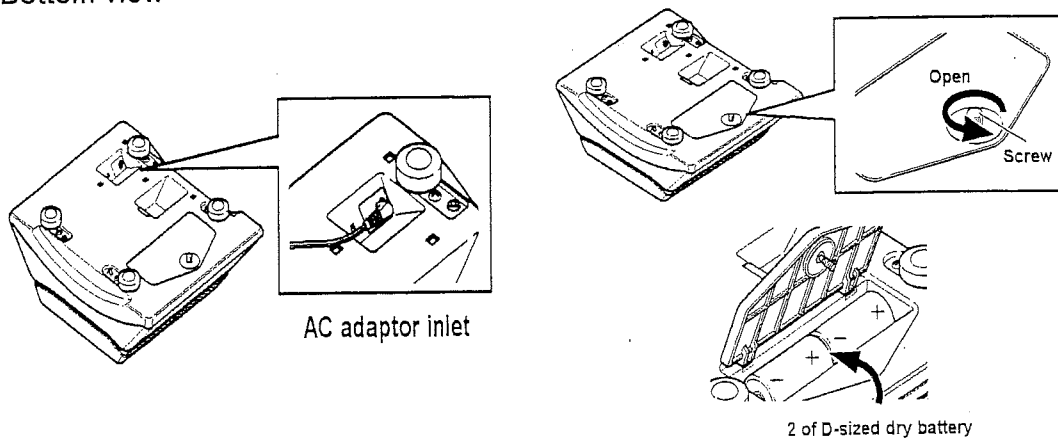

1.4 Operation Panel

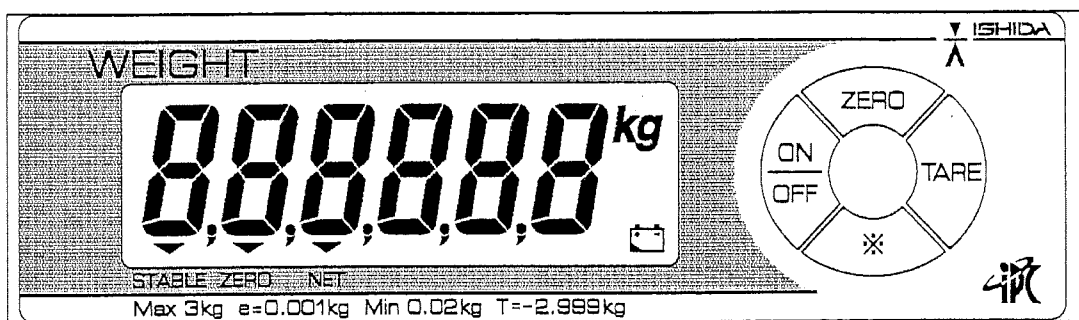

1.5 Outer Dimensions

Small size

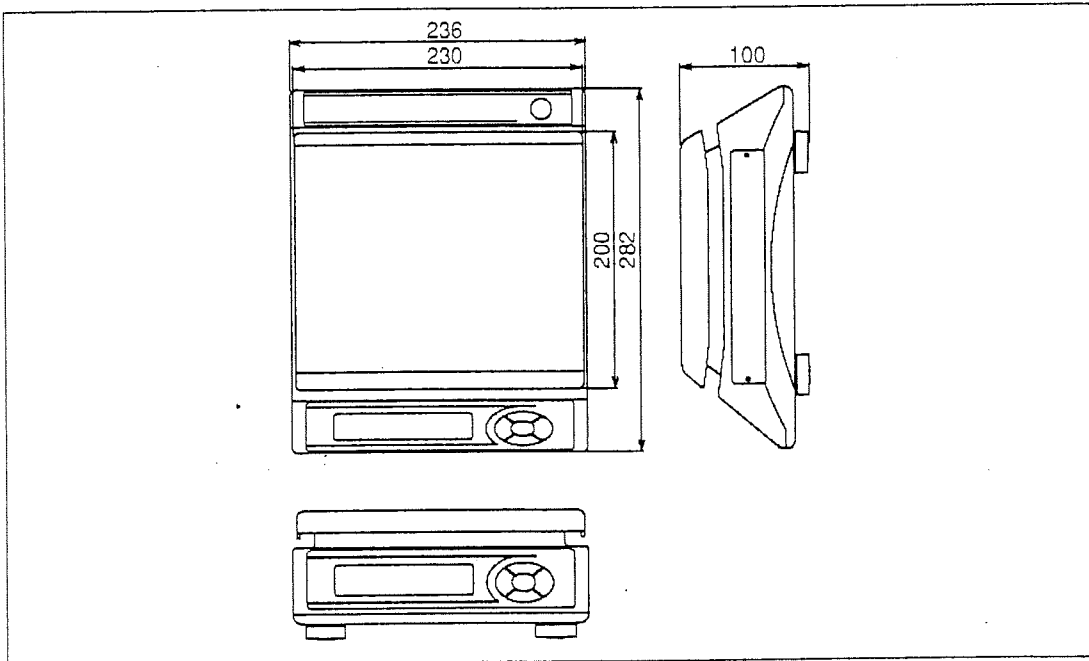

Large size

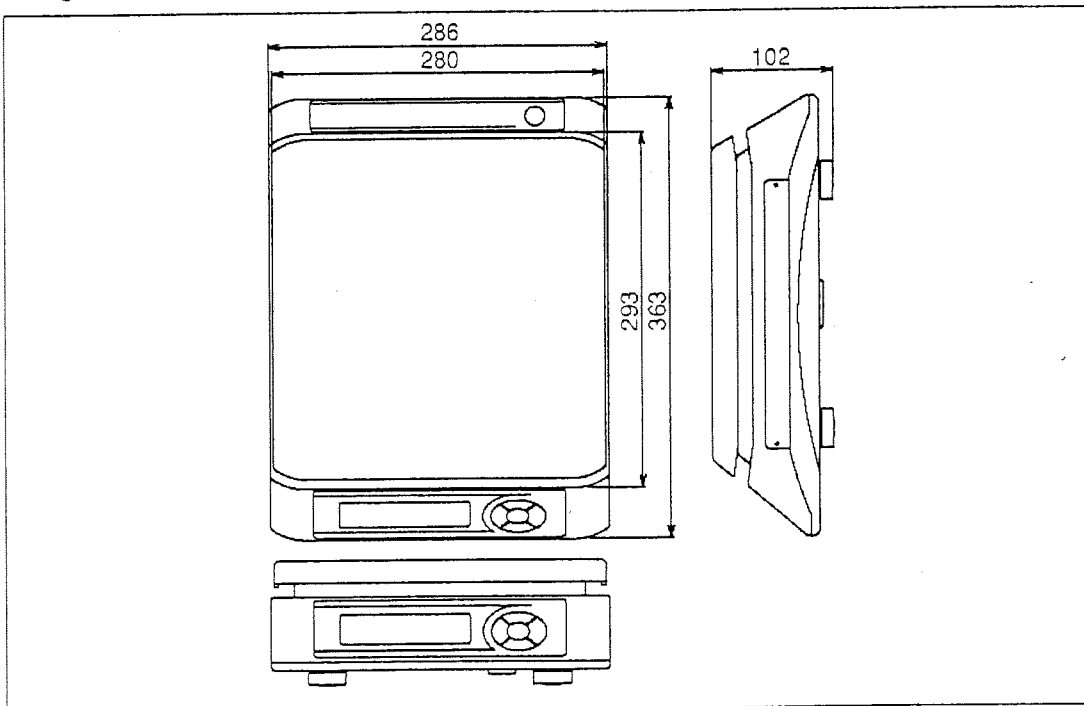

Chapter 2 Test Mode

The Test Mode is used for diagnosis and/or setting at maintenance service.

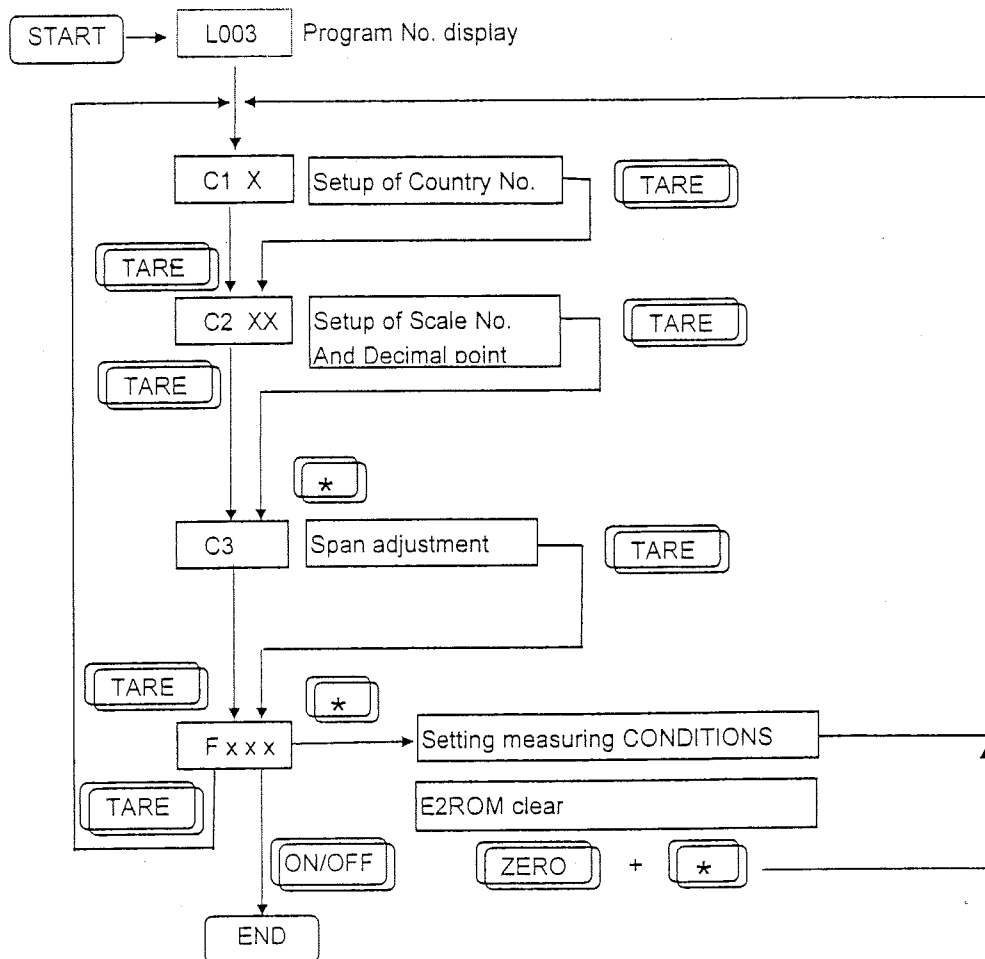

2.1 Operation

2.1.1 Test Mode Flow



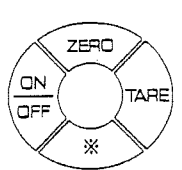

Note: Press the memory switch at any time during test mode to record the data to the E2PROM. Then "P-EP" appears in the display.

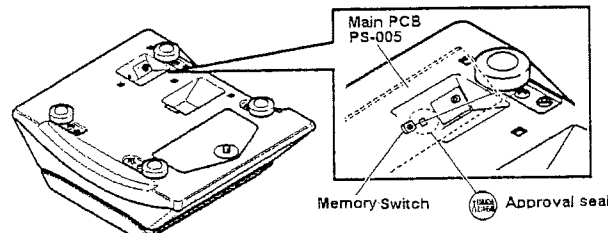

2.1.2 Key Functions (when setting value)

Key	Function
	ON OFF - Use at TEST mode startup. (Press this key while the TARE key is depressed.) - Use at TEST mode end
	ZERO - Use when selecting digits.
	TARE - Press when fixing values after mode or data selection. - Increments values for each press during data change.
	* - Press when entering C3 or F mode
 Memory Switch	(Tactile switch in the main circuit board) Stores E2ROM data set for each item of the C and F mode.
	

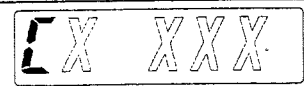

2.1.3 Starting Test Mode

Operation	Display
1. Press and release the ON/OFF key while the TARE key is depressed.	
2. Release the TARE key.	

2.1.4 Ending Test Mode

Operation	Display
1. C mode / F mode status	
2. Release the ON/OFF key after depressing for one second or more.	

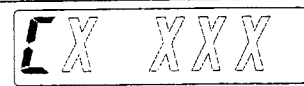
2.1.5 Memory Switch



Operation	Display
1. C mode / F mode status	
2. Press the  Memory Switch.	

2.1.6 C1 Mode – Country No. Setting

1) Country No. Table

Country No.							Item	Data	Weight	Digit	Bit
1	2	3	4	5	6	7					
JAPAN	ASIA AUS	EU	USA				Start range	0: ±10% 1: ±2%	1	10 ⁰	D0
0	0	0	0	0	1	0	Zero point mark	0: Lights on at true zero 1: Lights on at Provisional zero	2		D1
1	0	0	0	1	0	0	Below true zero indication	0: "____" 1: Negative value	4		D2
0	0	0	0	1	0	1	Cleaning tare weight by pressing ZERO key	0: No 1: Yes	8		D3
0	0	1	0	0	1	0	Decimal point Indicator	0: "." 1: ""	1	10 ¹	D4
0	0	0	1	0	0	0	Over-scale indication	0: BLANK 1: "OL"	2		D5
0	0	0	0	1	0	1	Tare subtraction	0: Possible 1: Not possible	4		D6
0	0	0	0	0	0	0	Reserve		8		D7
0	0	0	0	0	0	0	Stabilized, re-stabilized frequency	0: 5 times. 1: 8 times.	1		10 ²
0	0	0	0	0	0	0	Re-stabilization Starting range	0: 2 times over 1: 4 times over	2	D9	
0	0	0	0	0	0	0	Stabilized/re-stabilized range	0: 3 times 1: 5 times	4	D10	
1	0	0	0	0	0	0	Section adjustment	0: No 1: Yes (JAPAN)	8	D11	
804	000	010	020	04E	011	048	Display of F mode		Measurement Condition		

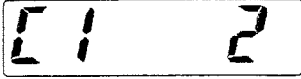
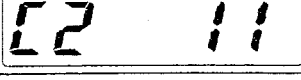
2) Operation

Operation	Display
1. Stating Test	
2. Setup of Country No. - To select the No., use the [*] key - Example: ASIA=2	
3. When the C2 mode is then required, press the TARE key. - When finishing, press the <input type="checkbox"/> Memory Switch to record the data to the memory, and enter the Ending Test Mode.	 

2.1.7 C2 Mode – Scale No. and Decimal point Setting

1) Scale No.[X1] Table

X1	Specifications		A/D Counts
1	3kg (2g/1g)	Multi interval	30000 (20/10)
2	6kg (5g/2g)	Multi interval	30000 (25/10)
3	15kg (10g/5g)	Multi interval	30000 (20/10)
4	30kg (20g/10g)	Multi interval	30000 (20/10)
5	3kg (1g)	Single range	30000 (10)
6	6kg (2g)	Single range	30000 (10)
7	15kg (5g)	Single range	30000 (10)
8	30kg (10g)	Single range	30000 (10)
9	6lb (0.005lb/0.002lb) / 3kg (2g/1g)	Multi interval lb/kg	30000 (25/10) / 30000 (20/10)
A	15lb (0.01lb/0.005lb) / 6kg (5g/2g)	Multi interval lb/kg	30000 (20/10) / 30000 (25/10)
B	30lb (0.02lb/0.01lb) / 15kg (10g/5g)	Multi interval lb/kg	30000(20/10) / 30000 (20/10)
C	60lb (0.05lb/0.02lb) / 30kg (20g/10g)	Multi interval lb/kg	30000(25/10) / 30000 (20/10)
D	100oz (0.1oz/0.05oz)	Multi interval oz	20000 (20/10)

2) Decimal point indication [X2] Table

X2	Display
1	"0"
2	"0.0"
3	"0.00"
4	"0.000"





3) Operation

Operation	Display
1. Stating Test	
2. Scale No. and Decimal point indication mode - Press the [TARE] key ON (1 st digit flashes) - Example: ASIA 3kg (1g) Single range X1=5, X2=4	
2.1 Scale No. Setting - Press the [*] key ON four times (X1=5)	
2.2 Decimal point indication Setting - Press the [ZERO] key ON (2 nd digit flashes)	
- Press the [*] key ON three times (X2=4)	
- When the C3 mode is required, press the TARE key.	
- When finishing, press the <input type="checkbox"/> Memory Switch to record the data to the memory, and enter the Ending Test Mode.	

2.1.8 C3 Mode – Span Adjustment

1) Operation

Operation	Display
1. Stating Test	
2. Span Adjustment mode	
2.1 Press the TARE key ON for two times.	
2.2 Press the [*] key ON displays original A/D data (The normal range for original A/D data is 1000 to 25000 counts).	
2.3 Press the [*] key ON with zero load on the weigh platter → Approx. 5000 count is displayed.	



2.4 Press the ZERO key if the count diverges from 5000 counts.	
2.5 Put the weight same as weighing capacity on the weigh platter, then press the [*] key "CAL" is displayed, then the A/D count becomes "35000" on the display. If the count diverges from 5000 counts, unload the weight and repeat the operations as set out in 2.4 and 2.5.	 
2.6 When the C3 mode is required, press the TARE key.	
- When finishing, press the <input type="checkbox"/> Memory Switch to record the data to the memory, and enter the Ending Test Mode.	

THIS ONE
CAL MODE
C3 MODE
P-EP

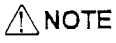

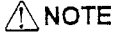

Last
of
360







 NOTE	<ul style="list-style-type: none"> • "CAL" operation can not be performed unless zero-point adjustment is finished. • "CAL" operation can not be performed unless the original A/D value exceeds 33300 counts when the weight is loaded.
---	--

2.1.9 F Mode – Setting measuring conditions and E2ROM clear

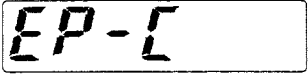
 NOTE	<ul style="list-style-type: none"> • All data has been fixed according to country specifications. • Altering data may not conform to weighing and measuring tests for a country.
 REFERENCE	<ul style="list-style-type: none"> • See 1.6 "C1 Mode-Country No. Setting" for Measurement Conditions Setup Table.

1) Operation

Operation	Display
1. Stating Test	
2. Setting measuring conditions 2.1 Press the TARE key for three times 2.2 Press the [*] key The least significant digit blinks. Whenever the [*] key is pressed, the required digit can be selected.	 
2.3 Whenever the [*] key is pressed, the figure of the digit which has blinked does the increment.	

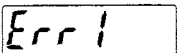
3. E2ROM clear Any scene of F mode is possible. 3.1 Press the ZERO key and [*] key. "EP-C" then "C1-1" is displayed.		
 NOTE	At this point, writing in E2ROM of change data in F mode and the default value to E2ROM clear has not been completed. Push the memory switch.	
 NOTE	E2ROM clear initializes Country No., Scale No., Zero, and Span adjustment values. It is necessary to set it again.	
4. Writing in E2ROM Push the memory switch to memorize data.		
 NOTE	After E2ROM is cleared, if writing is performed in E2ROM without setting Country No., Scale No. nor Zero/Span adjustment value, and the power is turned on, "Err1" is displayed and it is not possible to use the machine. Set C1, C2, and C3 again.	

Data after E2ROM is cleared

Mode	Data	Item
C1	1	JAPAN
C2	11	Scale No.= 3kg (2g/1g) Multi interval Decimal point indication=" 0"
C3		Zero point and span adjustment value and each approximate value
F	804	Measurement condition

2.1.10 Error No. List

Error No.	Mode	Item
Err1	At power ON	E2PROM unsetting or garbled data
Err2	At power ON	Outside start range
Err3	Test mode	Outside range where zero point can be adjusted (original A/D 1000 count or less)
Err4	Test mode	(Original A/D 25000 count or more)
Err5	Test mode	Outside span adjustment possible range (original A/D 33300 count or more)
Err6	Normal mode	Original A/D zero count or less

Chapter 3 Hardware Configuration

3.1 Mechanisms

3.1.1 Small Size (3kg, 6kg)

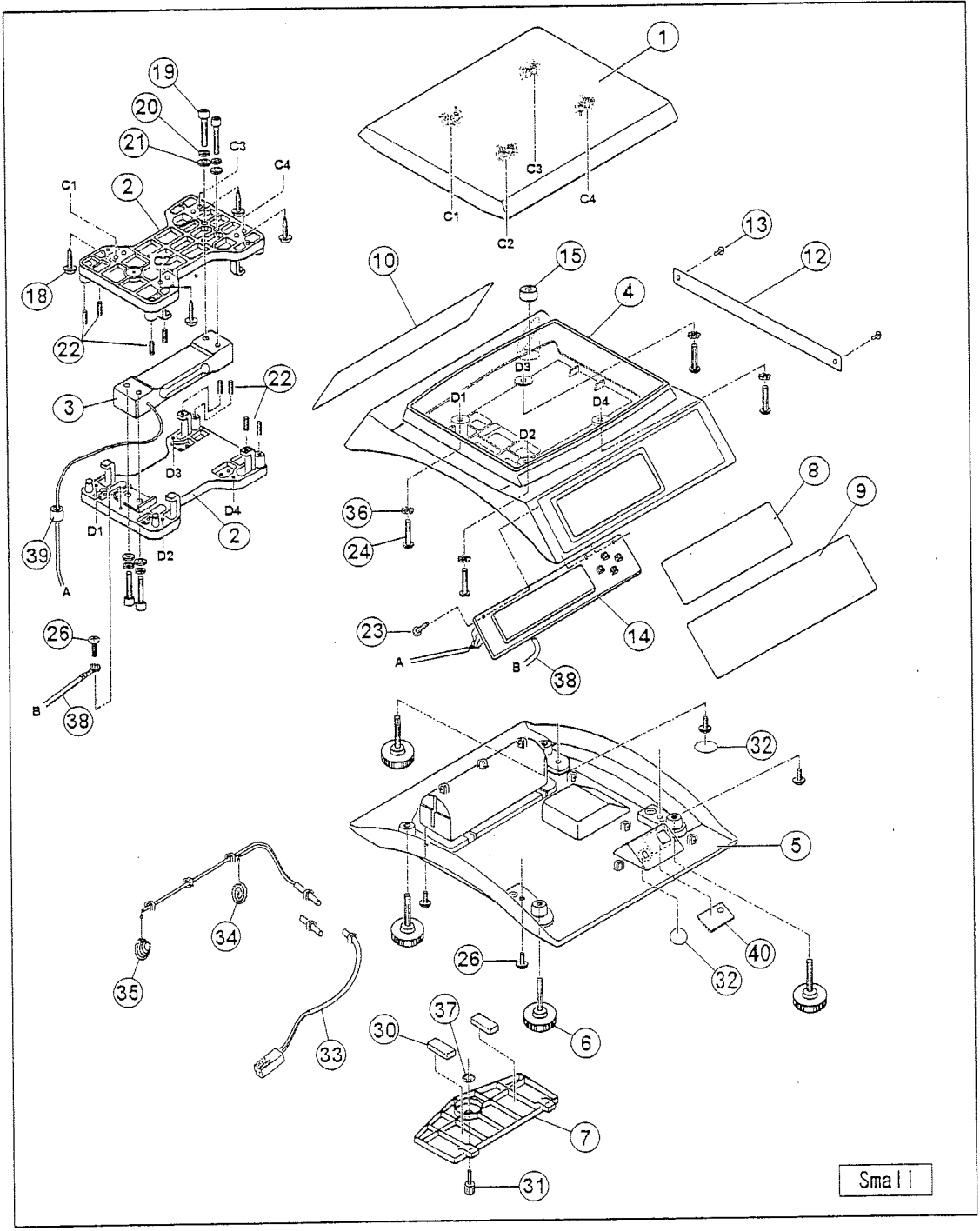

IPC 3kg 6kg Single Display Asia Service Parts List

No.	Parts Name	Weighing Capacity	Qty
1	PLATTER		1
2	PLATE: SUPPORT		2
3	LOAD CELL (CZL-6D-C3-5kg-1000)	3kg	1
3	LOAD CELL (CZL-6D-C3-10kg-1000)	6kg	1
4	CASE		1
5	BASE		1
6	FOOT: LEVEL		4
7	BATTERY: COVER		1
8	LUCENT: PLATE		1
9	SHEET: DISPLAY: FRONT	3kg	1
9	SHEET: DISPLAY: FRONT	6kg	1
10	SHEET: DISPLAY: REAR		1
11	SLEEVE		4
12	NAME PLATE: SPEC	3kg	1
12	NAME PLATE: SPEC	6kg	1
13	PUSH RIVET		2
14	PWB PS-005A		1
15	LEVEL UNIT		1
18	SCREW ST 4 x 14		4
19	SCREW M 6 x 25		4
20	WASHER 6		4
21	SPRING WASHER 6		4
22	SCREW M 4 x 12		8
23	SCREW ST 3 x 8		3
24	SCREW M 5 x 16		4
26	SCREW M 4 x 10		5
27	SCREW ST 4 x 10		2
30	CUSHION BATTERY		2
31	SCREW M 4 x 12		1
32	SHEET		2
33	BATTERY HARNESS		1
34	SPRING 1		1
35	SPRING 2		1
36	WASHER 5		4
37	E: RING 3		1
38	PRINTER GND CORD		1
39	FILTER		1
40	PROTECT:SHEET		1

Note: Parts number may change without notice due to product improvement.

3.1.2 Large Size (15kg \geq 30kg)

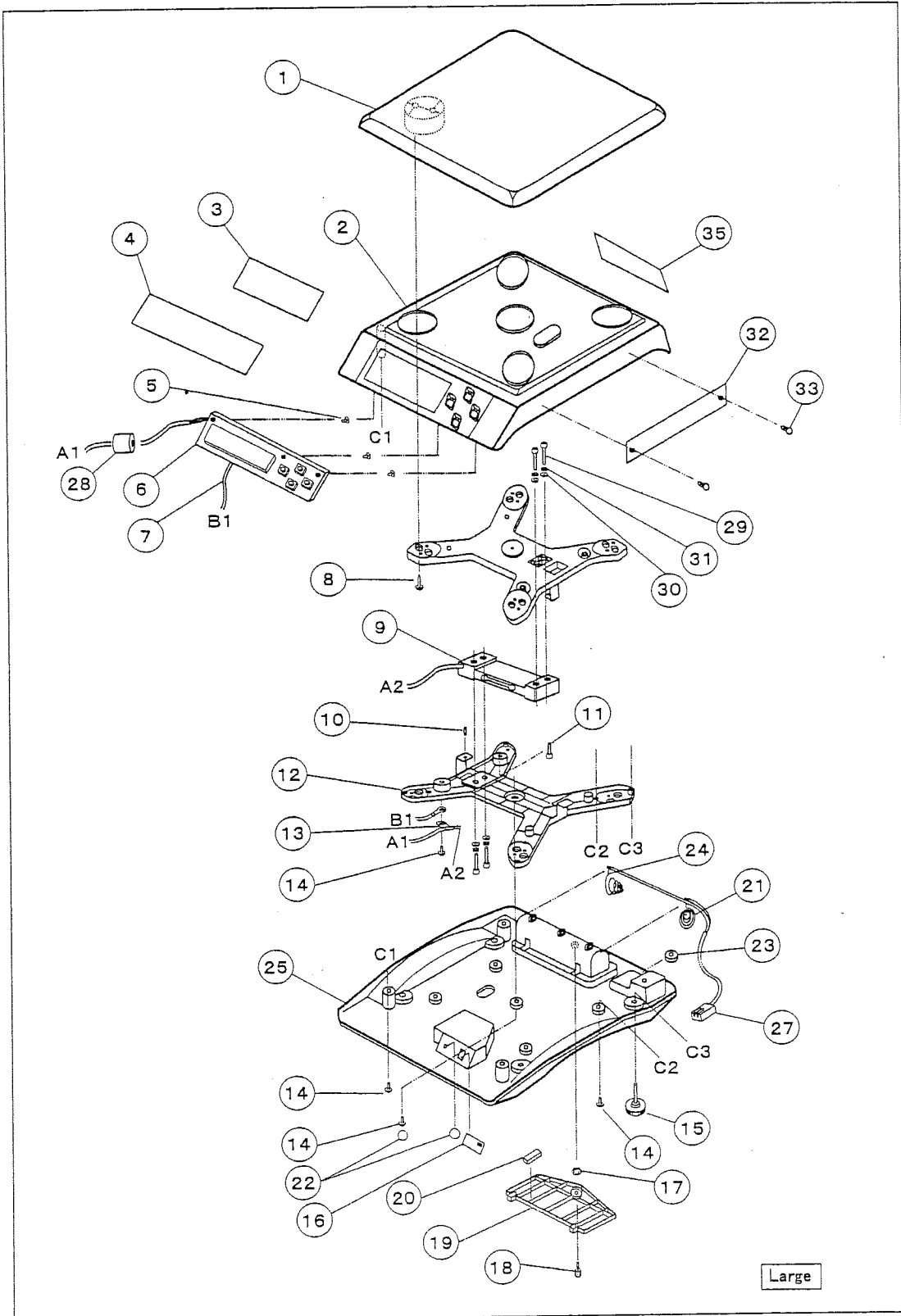

IPC 15kg,30kg Single Display Asia Service Parts List

No.	Parts Name	Weighing Capacity	Q'ty
1	PLATTER		1
2	CASE		1
3	LUCENT: PLATE		1
4	SHEET: DISPLAY: FRONT	15kg	1
4	SHEET: DISPLAY: FRONT	30kg	1
5	SCREW ST 3 x 8		3
6	PWB PS-005A		1
7	PRINTER GND CORD		1
8	SCREW ST 4 x 14		4
9	LOAD CELL (CZL-6D-C3-25kg-1000)	15kg	1
9	LOAD CELL (CZL-6D-C3-50kg-1000)	30kg	1
10	SCREW M 4 x 12		2
11	SCREW M 5 x 25		4
12	PLATE: SUPPORT		2
13	PLATE: A: COVER		1
14	SCREW M 4 x 10		9
15	FOOT: LEVEL		4
16	PROTECT: SHEET		1
17	E: RING 3		1
18	SCREW M 4 G12		1
19	BATTERY: COVER		1
20	CUSHION BATTERY		2
21	SPRING 1		1
22	SHEET		1
23	LEVEL UNIT		1
24	SPRING 2		1
25	BASE		1
27	BATTERY HARNESS		1
28	FILTER: CORE		1
29	SCREW M 6 x 25		4
30	WASHER 6		4
31	SPRING WASHER 6		4
32	NAME PLATE: SPEC	15kg	1
32	NAME PLATE: SPEC	30kg	1
33	PUSH RIVET		2
35	SHEET: DISPLAY: REAR		1

Note: Parts number may change without notice due to product improvement.

3.2 Electric Concerns

3.2.1 Block Diagram

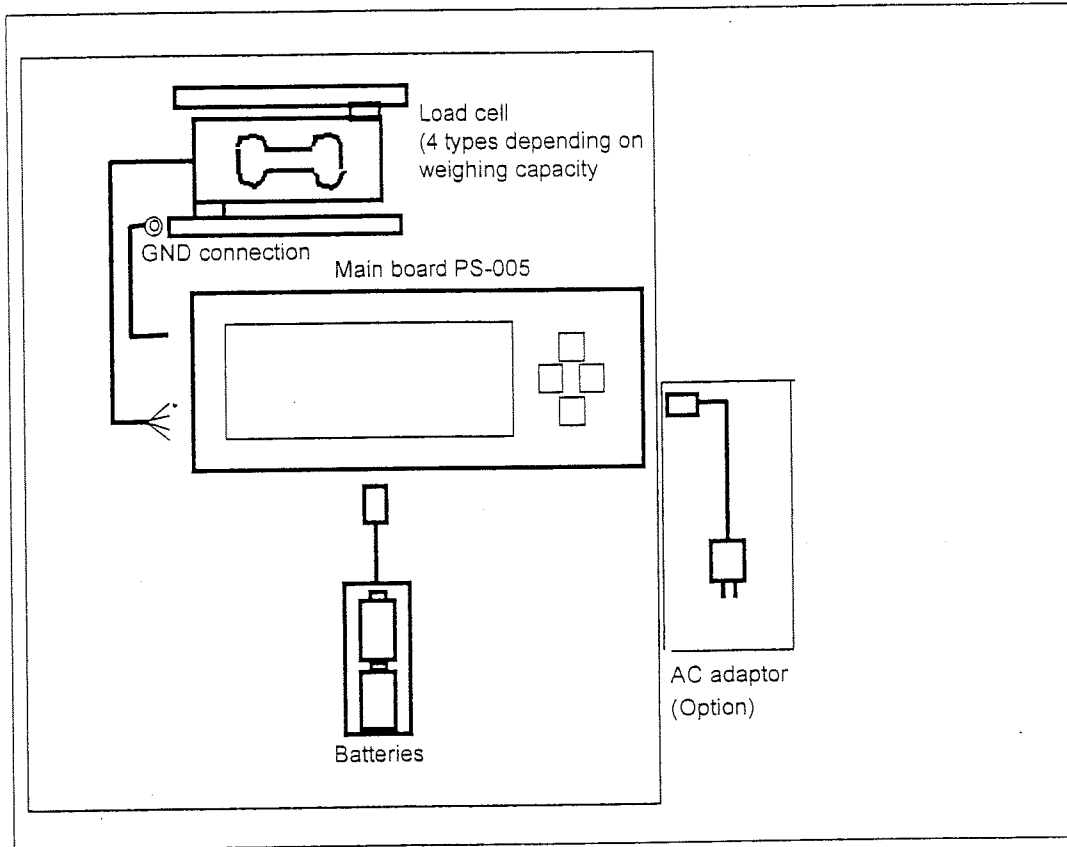

3.2.2 Board PS-005

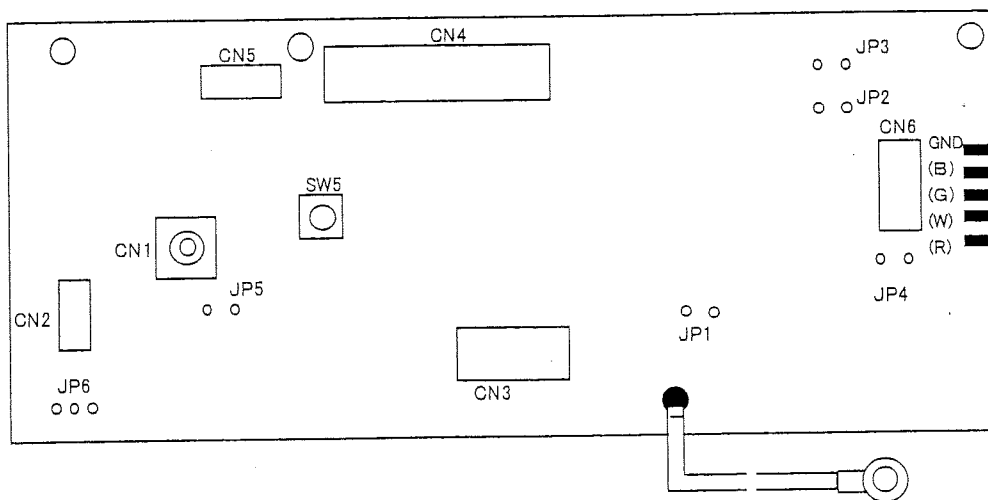

Connector

CN1: AC adaptor input

Pin No.	Function	Remarks
2	AC adaptor power source	DC 2.4 to 6.0V
3	GND (Circuit)	
4	GND (Battery)	

CN2: Battery input

Pin No.	Function	Remarks
1	GND (Battery)	
2	Battery power source	DC 2.2 to 3.2V

CN3: Not used

CN4: LCD display data output

CN5: Not used

CN6: Load cell input

Pin No.	Soldering land	Function	Remarks
1	(R)	Vcc	DC5v
2	(W)	GND	GND
3	(G)	IN+	Approx 2.5v
4	(B)	IN-	Approx 2.5v
5	GND	GND	GND

Jumper

- JP1: Ferrite cut
- JP2: Ferrite cut
- JP3: Ferrite cut
- JP4: Ferrite cut
- JP5: Battery GN and Circuitry GND
- JP6: Filter cut

Switch

- SW5: E2ROM Memory switch

Chapter 4 Maintenance

4.1 Disassembly Procedure (Small Size: 3kg • 6kg)



NOTE

The seal restricts the peel according to the country by a no report and doing as wanting put it. Follow the relevant procedure for the respective countries.

4.1.1 Base Replacement

Disassembly procedure

1. Remove dry batteries when using batteries. Remove the AC adaptor when using the AC adaptor.
2. Remove four foot levels.
3. Peel off the approval seal.
4. Remove the four M4×10 screws.
5. Lift the base, and pull out the battery harness from CN2 of main board PS-005.

Assembly procedure

1. Perform in reverse order to disassembly.
2. The approval seal material is a void seal. It is not possible to use it again. Use a new approval seal.

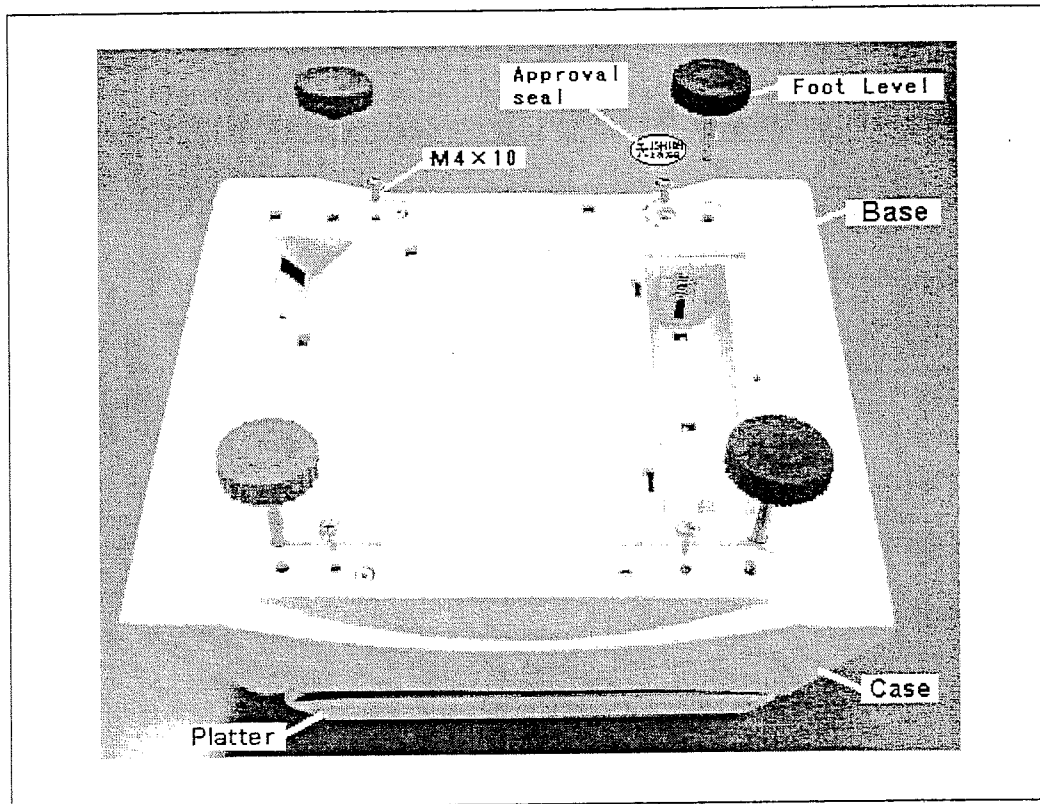

4.1.2 Board Replacement

1. Remove the load cell cable and grand cable using the soldering iron.
2. Remove the three ST3×8 screws where the board is fixed.
3. The board is fixed with four hooks and one lib as shown in the photo.
Press down the place shown by the arrow while pulling towards yourself, then remove the hook 1 by sliding the entire board to the left and out.
4. Perform in reverse order for assembly.
5. Then, install the base.
6. Install dry batteries, clear E2ROM, and perform settings and span adjustment in C1, C2, and C3 modes.

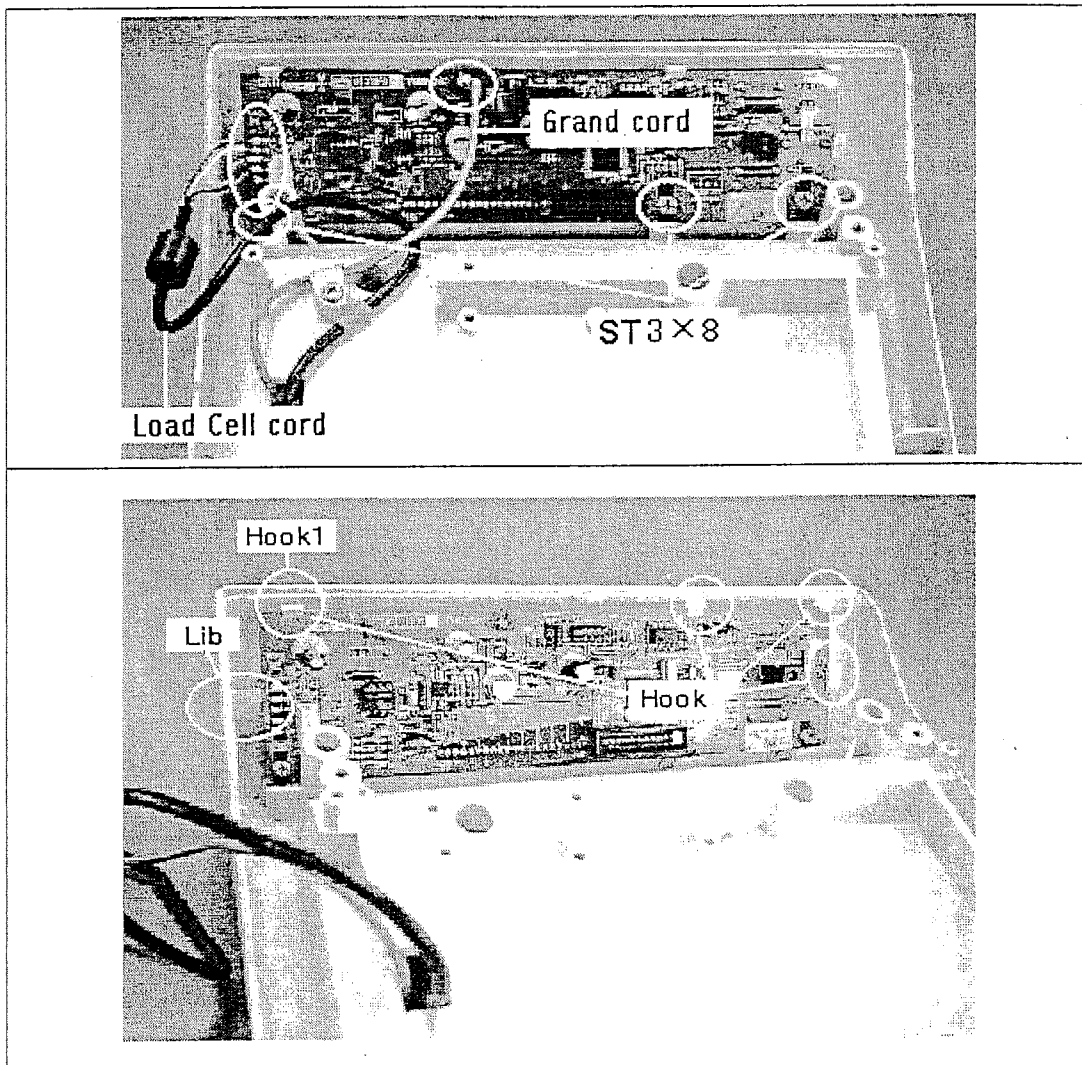

4.1.3 Load Cell Replacement

1. Remove the load cell cable and ground cable by using the soldering iron.
2. Remove the ST4×10 screw which fixes the cable clamp.
3. Remove the four M5×16 screws which fix the plate support at four case locations.
4. Remove the case.

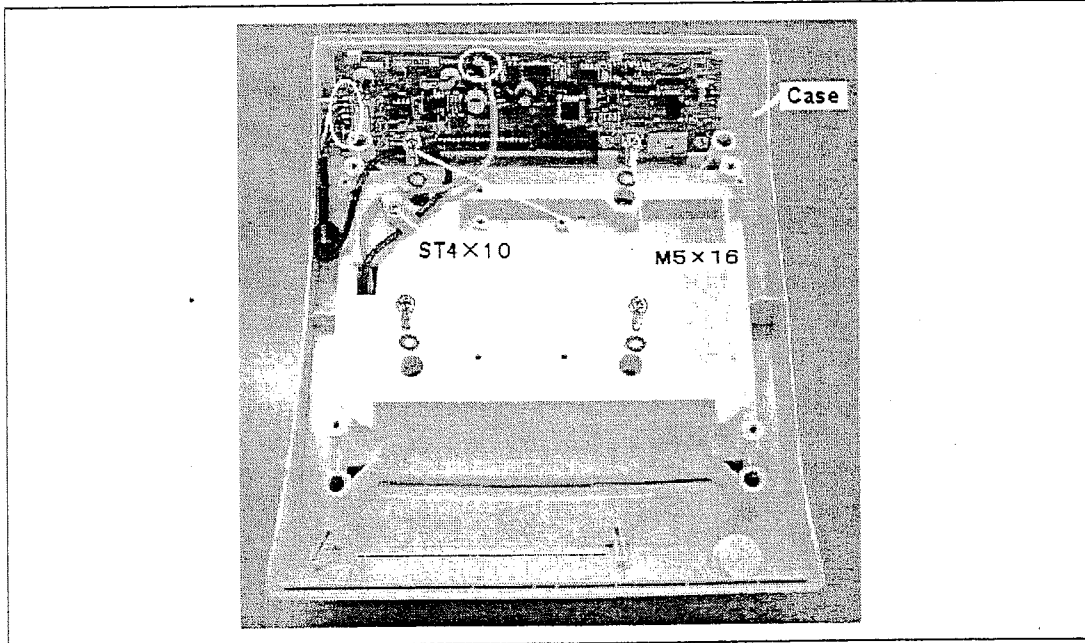

5. Remove the four ST4×14 screws which fix the plate support and platter.

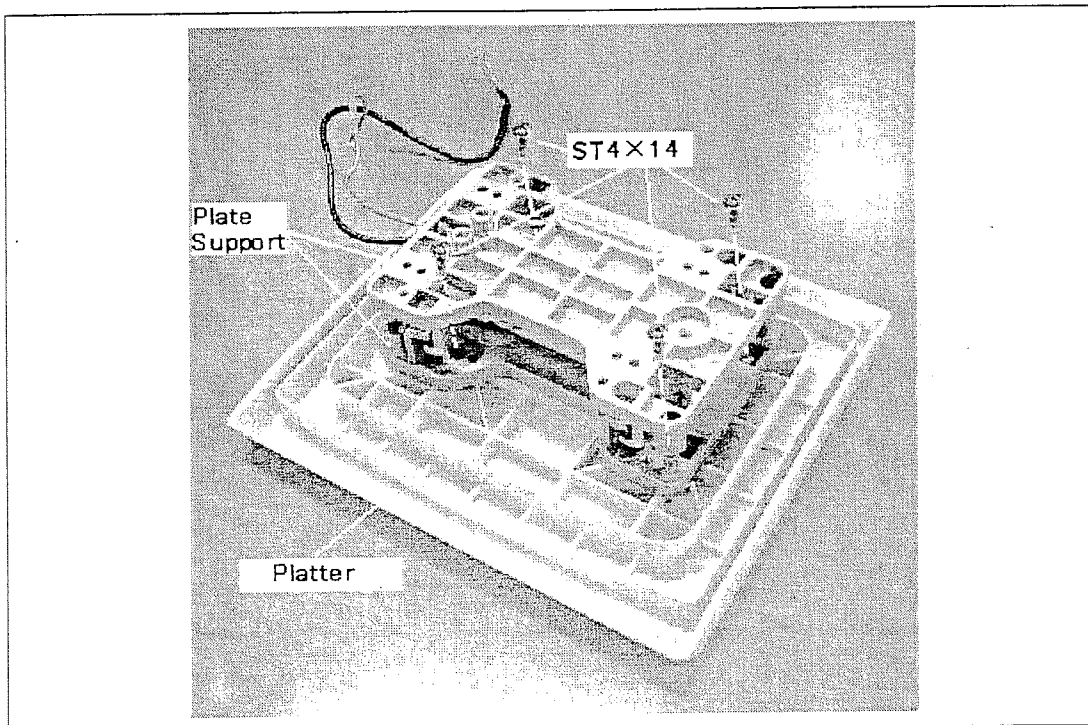

- Remove the M6×25 hexagonal bolts, spring washers and flat washers, which fix the plate support and load cell in two locations both above and under.

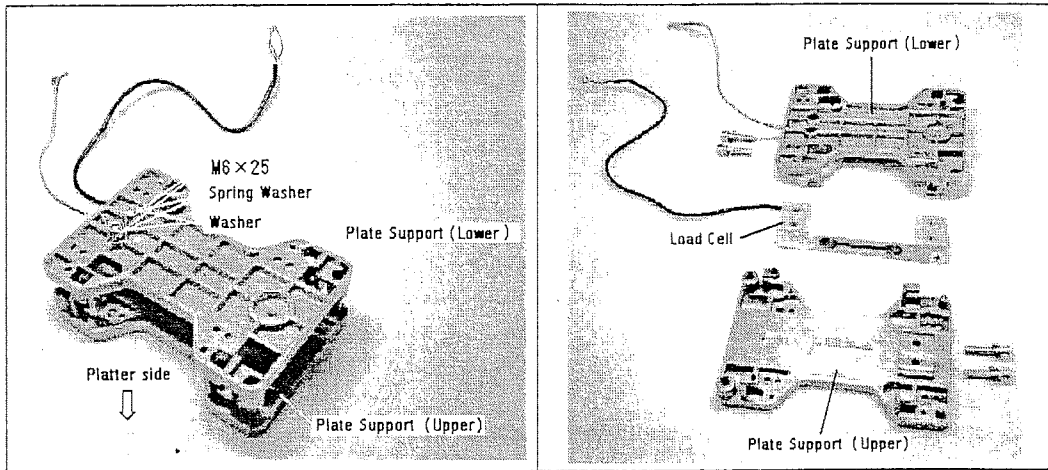

- Fix a new load cell and fix in four locations on the upper and lower plate support with flat washers, spring washers, and M6×25 hexagonal bolts order.
The direction of load cell installation should be carried out on the lower plate support on the cell cable side.
- Confirm whether each cell limit space in the 8-location set screws is within a specified value.
Adjust by turning the set screws to the regulations value, and apply the screw lock agent if differing from a specified value.

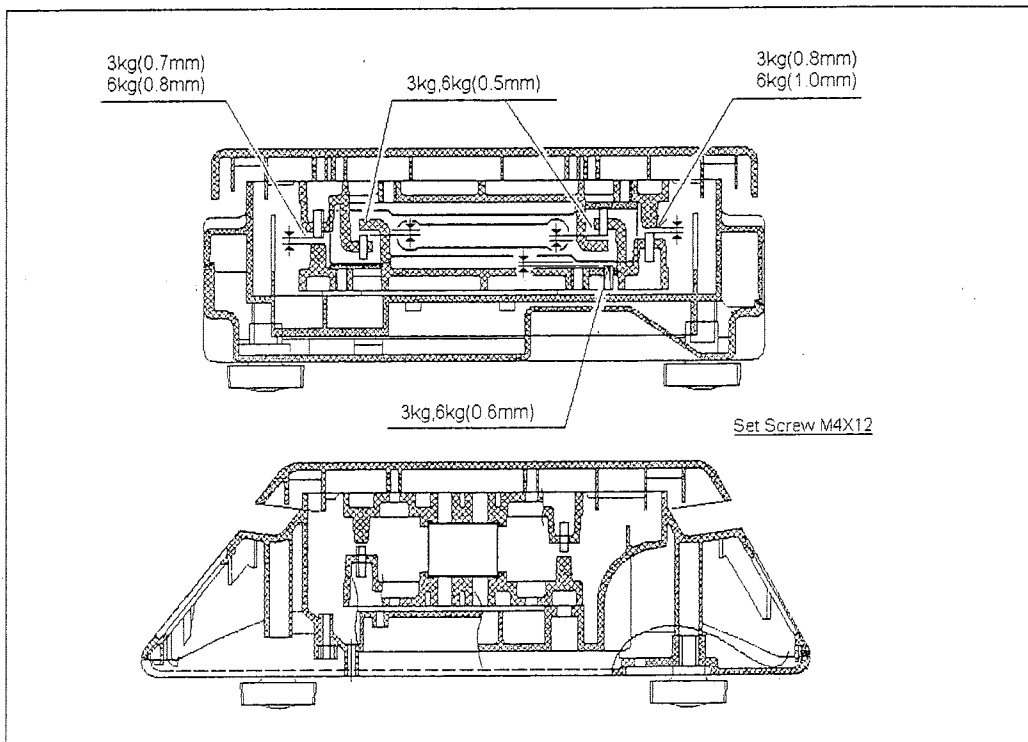

- Start the test mode, and perform the C3 mode span adjustment.

4.2 Assembly Procedure (Large Size: 15kg • 30kg)

4.2.1 Base Replacement



NOTE

The seal restricts the peel according to the country by a no report and doing as wanting put it.
Do the procedure in a pertinent country.

Disassembly procedure

1. Remove two dry batteries when using the batteries. Remove the AC adaptor when using the AC adaptor.
2. Remove the four foot levels.
3. Peel off the approval seal.
4. Remove the four M4×10 screws.
5. Lift the base, and pull out the battery harness from CN2 of the main board PS-005.

Assembly procedure

1. Do in the reverse order for assembly.
2. The material of approval seal is void seal. It is not possible to use it again. Put a new approval seal.

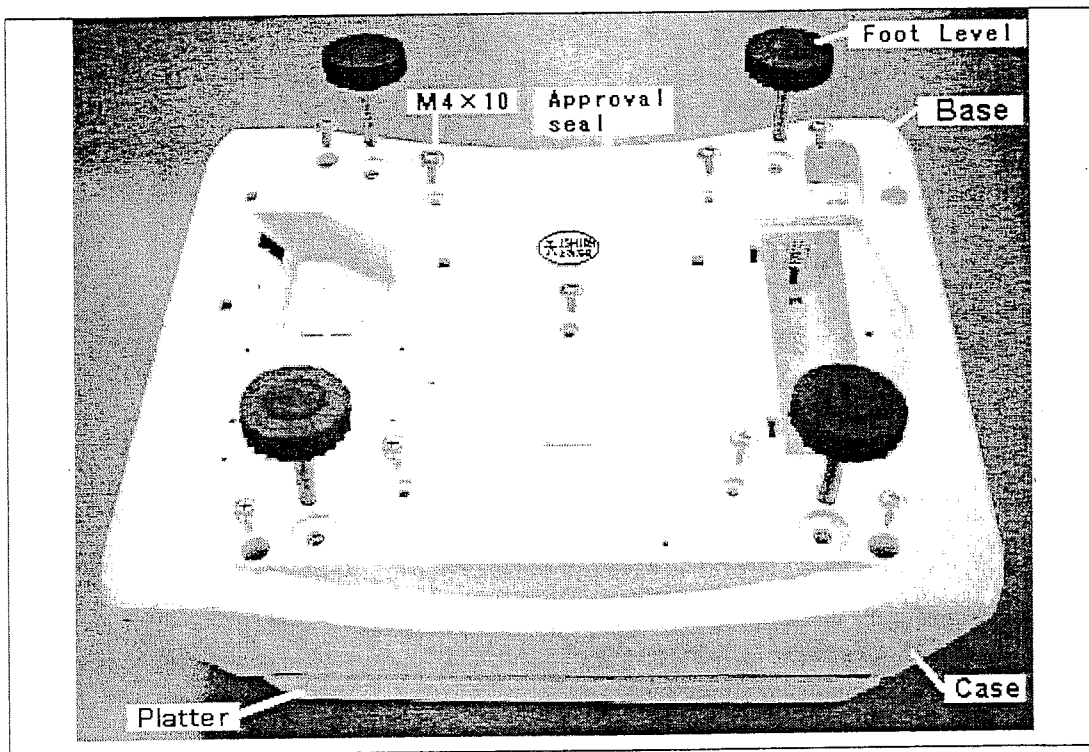

4.2.2 Board Replacement

1. Remove the load cell cable and ground cable by using the soldering iron.
2. Remove the three ST3×8 screws where the board is fixed.
3. The board is fixed with the four hooks and one lib as shown in the photo.
Press down the place shown by the arrow, while pulling towards yourself, then remove the hook 1 by sliding the entire board to the left and out.
4. Do in the reverse order for assembly.
5. Then, install the base.
6. Install the two dry batteries, clear E2ROM, and perform settings and span adjustment in C1, C2, and C3 modes.

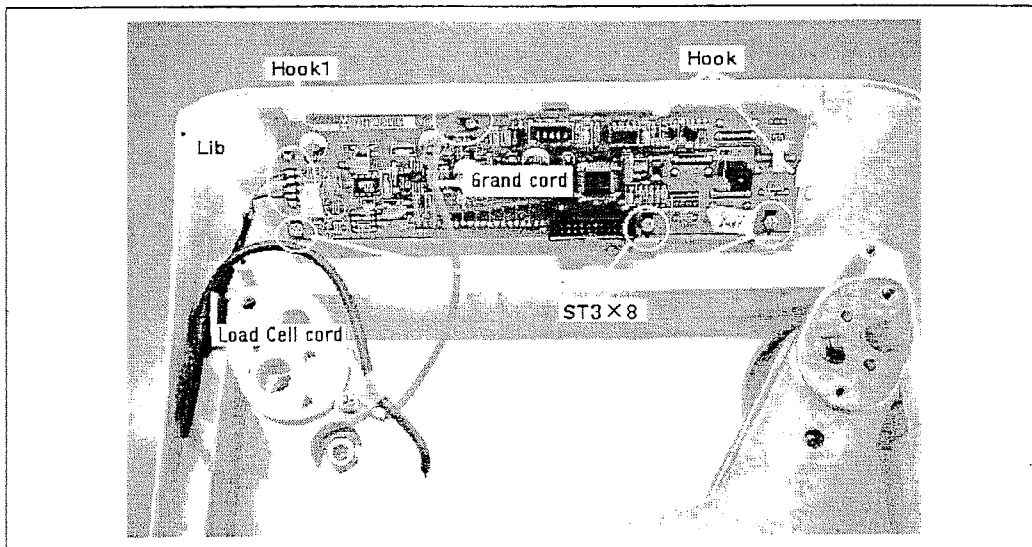

4.2.3 Load Cell Replacement

1. Remove the load cell cable using the soldering iron.
2. Remove the M4×10 screw which fixes the cable clamp, then remove the ground cable and load cell cable.
3. Remove the four ST4×16 screws where the platter and plate support are fixed.

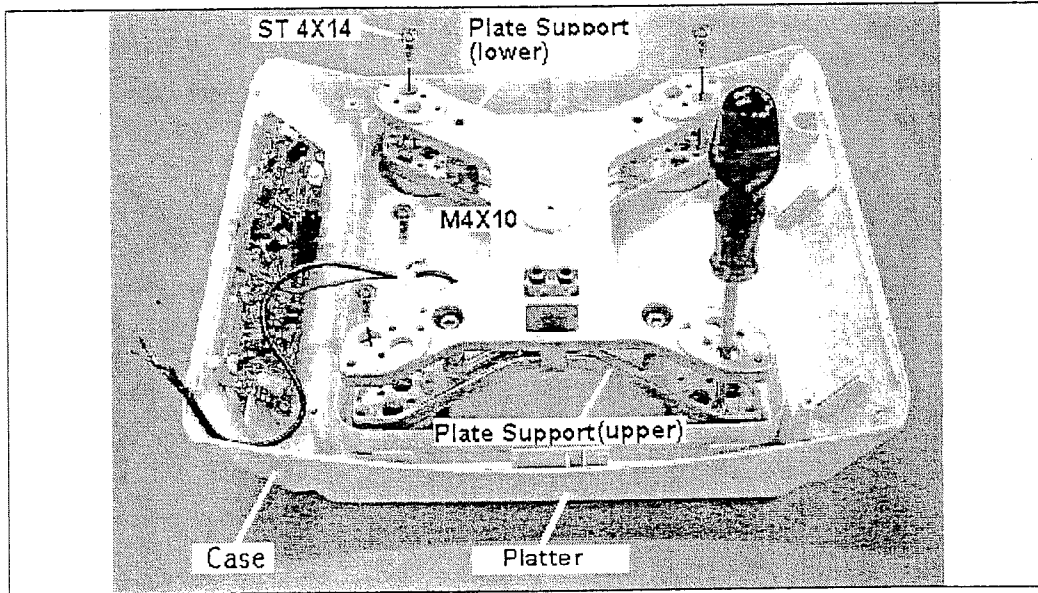

4. Remove the M6×25 hexagonal bolts, spring washers and flat washers, which fix the plate support and load cell in two locations both above and under.

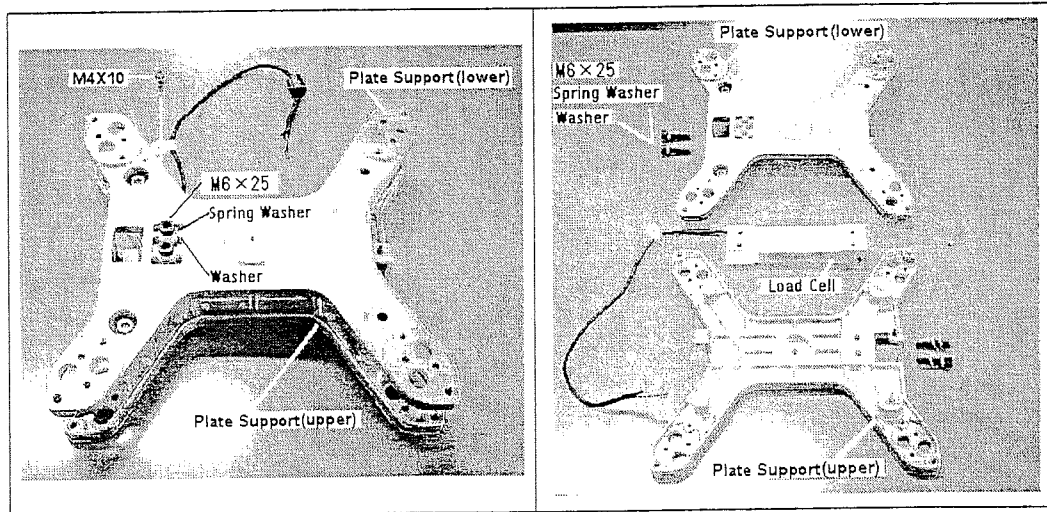

5. Fix a new load cell and fix in four locations on the upper and lower plate support with flat washers, spring washers, and M6×25 hexagonal bolts order.
The direction of load cell installation should be carried out on the lower plate support on the cell cable side.
6. Confirm whether each cell limit space in the 8-location set screws is within a specified value.
Adjust by turning the set screws to the regulations value, and apply the screw lock agent if differing from a specified value.

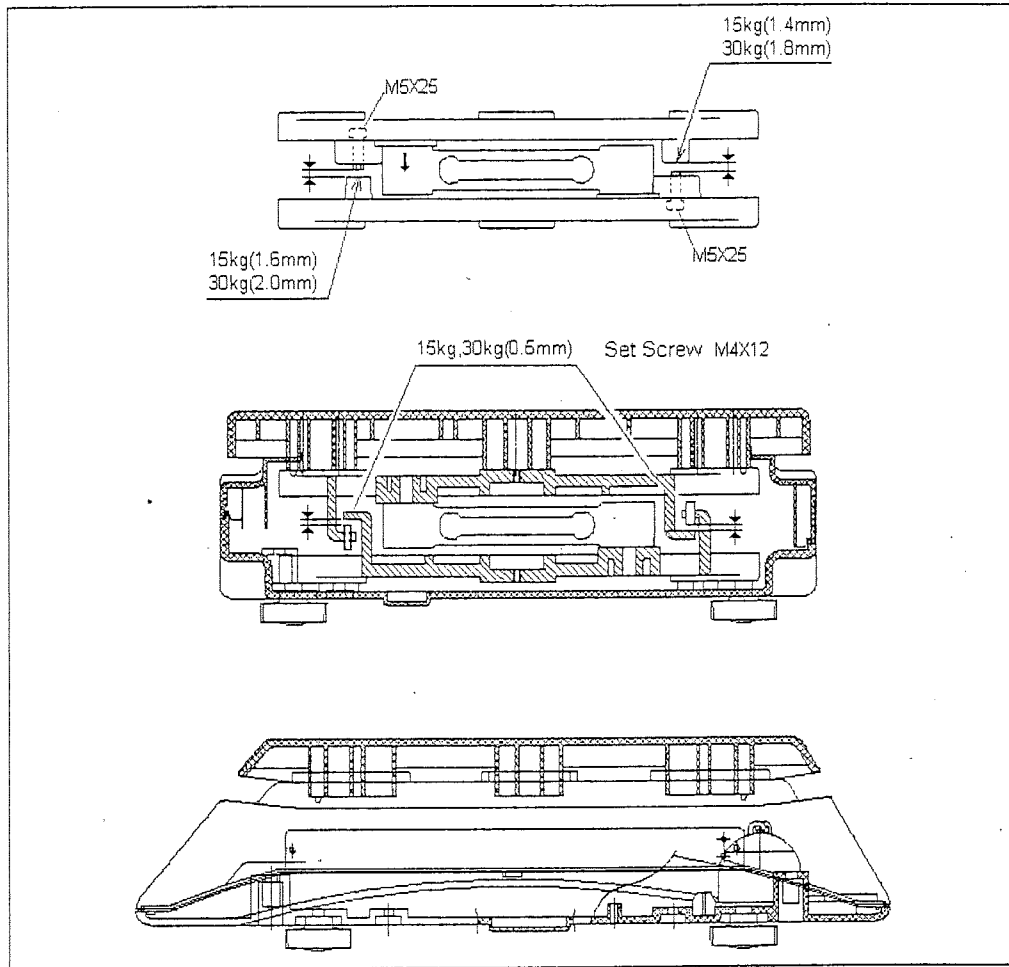

7. Start the test mode, and perform the C3 mode span adjustment.

4.3 Troubleshooting

Symptom	Cause	Measure
1. The display check does not start when the power switch is pushed.	1. Trouble of dry battery power supply system	<ul style="list-style-type: none"> • Check and replace dry batteries • Confirmation and exchange of battery harness
	2. AC adaptor trouble	<ul style="list-style-type: none"> • Check output voltage (DC2.4-6.0V) and replace AC adaptor
	3. Main board trouble	<ul style="list-style-type: none"> • Replace the main board PS-005A.
2. Power ON Display check "Err1"	1. Garbled E2ROM data or initialized state.	<ul style="list-style-type: none"> • Initialize, perform C1, and C2 and C3 settings, then push the memory switch.
	2. Main board PS-005A trouble	<ul style="list-style-type: none"> • Replace the main board PS-005A.
3. Power ON Display check "Err2"	1. Outside weight value start range	<ul style="list-style-type: none"> • Check if anything is placed on the platter. If so, remove it. • Replace the load cell. • Replace the main board PS-005A.
4. Power ON Display check "0"kg does not appear on the display.	1. Weight value is unstable.	<ul style="list-style-type: none"> • Check if something comes in contact with the platter. If so, remove it. • Check if there is wind or vibration near the machine. If so, avoid these. • Replace the main board PS-005A. • Replace the load cell.
5. Weight varies at four corners.	1. External or load cell trouble	<ul style="list-style-type: none"> • Check if the horizontal state is being kept. • Check if there is foreign article between the platter and the case. • Check if space of limit adjustment screw is narrow • Replace the load cell.
6. The ZERO or TARE key does not function.	1. Outside of zero-adjustment or tare subtraction range	<ul style="list-style-type: none"> • Check that zero-adjustment or tare subtraction is within the specified range.
	2. Weight value is unstable.	<ul style="list-style-type: none"> • Check if something comes in contact with the platter. If so, remove it. • Check if there is wind or vibration near the machine. If so, avoid these. • Replace the main board PS-005A. • Replace the load cell.
7. The power supply cuts when time passes.	1. Auto power OFF setting.	<ul style="list-style-type: none"> • Check if the auto power OFF function works. • Default is 60 minutes.
	2. Main board PS-005A trouble	<ul style="list-style-type: none"> • Replace the main board PS-005A.

