

Rice Lake Digital Physician Scale

140-10 Series

Software Revision 11387

Technical and Operating Instructions



RICE LAKE[®]
WEIGHING SYSTEMS
To be the best by every measure[®]

Contents

- 1.0 Introduction..... 1**
- 2.0 Scale Assembly 2**
 - 2.1 Unpacking Your Scale 2
 - 2.2 Repacking 2
 - 2.3 Setting Up Your Scale 2
 - 2.4 Getting Ready to Weigh a Patient..... 3
- 3.0 Scale Operation 4**
 - 3.1 Weighing 4
 - 3.2 Using the Body Mass Index (BMI) Function..... 5
 - 3.3 Using the Tare Function 6
- 4.0 Scale Configuration 7**
 - 4.1 Enabling Configuration or Calibration Modes 7
 - 4.2 Configuration Mode 7
 - 4.3 Numeric Data Entry 8
 - 4.4 Reset To Factory Defaults 12
- 5.0 Scale Calibration 13**
- 6.0 RS-232 Communication 14**
 - 6.1 Pushbutton Keypad Print 14
 - 6.2 Standard Remote Protocol (configuration option #9 set to 1) 14
 - 6.3 ESC Protocol (configuration option #9 set to 0) 15
 - 6.4 Sample and Explanation of ESC Protocol..... 18
- 7.0 Troubleshooting and Testing..... 20**
 - 7.1 Test Mode 21
- 8.0 Maintenance 23**
 - 8.1 Basic Maintenance..... 23
 - 8.2 Cleaning..... 23
- 9.0 Digital Physician Scale Specifications..... 24**
- For More Information 25**
- Digital Physician Scale Limited Warranty 26**

 *Technical training seminars are available through Rice Lake Weighing Systems. Course descriptions and dates can be viewed at www.ricelake.com or obtained by calling 715-234-9171 and asking for the training department*



Rice Lake continually offers web-based video training on a growing selection of product-related topics at no cost. Visit www.ricelake.com/webinars.

1.0 Introduction

The Rice Lake Digital Physician Scale is efficiently designed in eye, waist - and floor-level configurations. Each scale is designed to provide accurate, reliable and repeatable weight measurements and has features that enable a fast and convenient weighing process. The eye and waist level model scales are also designed with a large hook handle and two heavy-duty rear wheels for easy portability.



This manual can be viewed and downloaded from the Rice Lake Weighing Systems web site at www.ricelake.com/health. Rice Lake Weighing Systems is an ISO 9001 registered company.



Figure 1-1. Digital Physician Scale (all three models shown)

2.0 Scale Assembly

2.1 Unpacking Your Scale

Place the unopened box in an open area that ample room for unpacking the scale.

Parts contained in the shipping box include:

- The scale
- This manual
- AC adaptor (in white box).
- Scale feet

2.2 Repacking

If the Digital Physician Scale must be returned for modification, calibration or repair, it must be properly packed with sufficient packing materials. Whenever possible, use the original carton when shipping the scale back.



Note *Damage caused by improper packaging is not covered by the warranty.*

2.3 Setting Up Your Scale

Use the following steps to set up the Digital Physician Scale. Setup is basically the same for all three models.

Tools needed for setup include:

- 6 mm hex Allen key (included)
- 4 mm hex Allen key (included) - needed for height rod only

Use the following steps to set up the scale.

1. Locate the operator's manual from inside the box and set aside as it will provide instructions on the proper scale removal and set up.
2. Carefully lift the scale out of the packaging material that it came in - lifting it out by the scale base.



Note ***DO NOT lift the scale out of the box by just the scale column. This could cause the hinge to break.***

3. Move the scale into the area where the weighing process will occur. It's recommended to place the scale on a hard, level surface for the most accurate weighments. Thin carpeting is fine but not recommended.
4. Attach the scale feet to the bottom of the scale base by screwing them into the scale base until snug. The level bubble on the scale base should indicate that the scale is level. If not, screw out scale feet until bubble becomes centered.

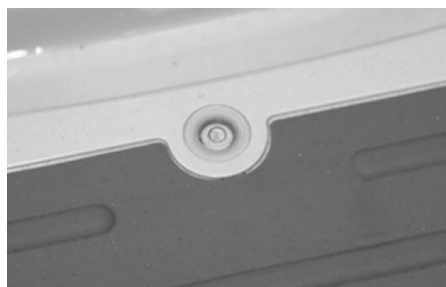

Figure 2-1. Bubble Should be Centered to Indicate that the Scale is Level

5. Loosen hex screw on waist and eye level models.
6. Unfold and set upright.
7. Tighten the hex screw head very firmly into the hinge at the base of the scale using the 6 mm Allen key to help stabilize the scale.
8. Assemble the height/measuring rod (for the eye level model only).
Insert the rod into the pillar base slot and feed the screw into the hole. Using the 4 mm Allen key, tighten the height rod to the scale from the back.

AC Power Connections

The Digital Physician Scale has a 120 VAC adaptor or 230 VAC adaptor to use when power is readily available. The AC power adaptor plugs into the back of the indicator as shown in Figure 2-2.

Connect the AC power source here.

LED indicator light illuminates from red to green when charged.

Store the 120 VAC adaptor here when not in use

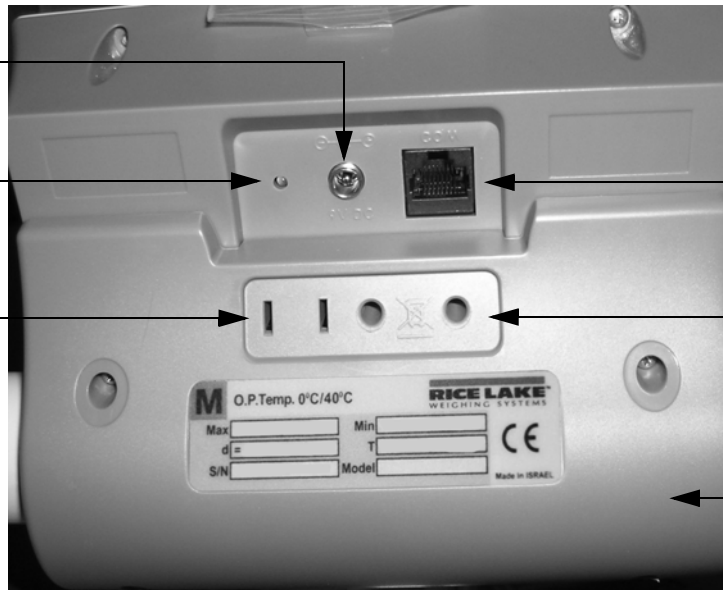

RS-232 Port connection

Store the 230 VAC adaptor here when not in use

Back cover to indicator

Figure 2-2. LED Light Location

The AC adaptor, when not in use, plugs into the back housing of the indicator. Figure 2-2 shows that location.

The Digital Physician Scale is capable of running its internal sealed lead-acid rechargeable battery if no additional power source is available. Battery life is approximately 75 hours. If the *LO Bat* indicator is showing on the display, recharge the battery or connect the scale to an AC power source as soon as possible for accurate weighing.

Battery Charging

When the AC adaptor is connected to a power source, the rechargeable battery goes into recharge mode.



Note To maintain battery longevity we recommend you charge it on a regular basis rather than waiting until it is fully discharged.

The LED indicator light on the back of the scale housing will illuminate red during the charging period, and change over to green when the battery becomes fully charged.

2.4 Getting Ready to Weigh a Patient

Once the scale is properly unpacked and set up, and prior to weighing a patient, step on the scale to check the scale that all functions are working correctly. The scale is calibrated from the factory so simply turn on the scale and step on the scale to get a weight reading. Press the **REWEIGH** key again to verify that weight.



Figure 2-3. Press the Reweigh Key to Verify Weight

3.0 Scale Operation

The display has various front panel keys. They are shown below.



Figure 3-1. Front Panel Display Keys

Key	Name	Function
	ON-OFF/ZERO	ON-OFF - Switches the scale on or off ZERO - Clears weight off the scale and returns it back to zero.
	BMI/TARE	BMI - Enables the user to access the BMI (Body Max Index) function. TARE - Used to subtract a weight off the scale ie: wheelchair
	REWEIGH	Allows you to reweigh a patient without having them leave the scale.
	Kg-Lb/PRINT	Allows the user to toggle between kilograms and pounds. Press this key to print a weight if connected to a printer.

Table 3-1. Key Functions

Caution *The keys on the front panel display are very sensitive so only a gentle pushing motion is required to obtain results.*

The scales have the capability of performing different operations beyond just calculating weight. The various operating instructions are described below.

3.1 Weighing

Use the following steps to weigh a person.

1. Press the **On-Off/Zero** key to turn on the scale and *0.0* will appear on the display.
2. Ask the patient or person to step onto the scale. The display shows *WEIGH*, then the person's weight, and beeps to indicate the end of the weighing process.
3. To reweigh, press the **REWEIGH** key.
4. To change the display from **Kg** to **Lb** and vice-versa, press the **Kg-Lb** key.
5. If the display hold feature is on ($OP6=1$), the weight will remain on the display even after the patient steps off the scale. To clear the weight, press the **On-Off/Zero** key.
6. To turn off the scale, press and hold the **On-Off/Zero** key until *OFF* appears on the display.

3.2 Using the Body Mass Index (BMI) Function

Body mass index (BMI) is the relationship between weight and height associated with body fat and health risk. It is a reliable indicator of body fatness for people and even though BMI does not measure body fat directly, research has shown the BMI correlates to direct measures of body fat. BMI is an inexpensive and easy-to-perform method of screening for weight categories that may lead to health problems for adults.

Calculating BMI is one of the best methods for population assessment of overweight and obesity. Because calculation requires only height and weight, it is inexpensive and easy to use for clinicians and for the general public. The calculation is based on the following formulas:

Calculate BMI by dividing weight in pounds (lbs) by height in inches (in) squared and multiplying by a conversion factor of 703.

Example: weight = 150 lbs, height = 5'5 (65")

Calculation: $[150 \div (65)^2] \times 703 = 24.96$

The standard weight status categories associated with BMI ranges for adults are shown in the following table.

BMI	Weight Status
Below 18.5	Underweight
18.5 - 24.9	Normal
25.0 - 29.9	Overweight
30.0 and Above	Obese

Table 3-2. Standard Weight Status

The following examples show weight ranges, the corresponding BMI ranges and the weight status categories for a sample height.

Height	Weight Range	BMI	Weight Status
5'9"	124 lbs or less	Below 18.5	Underweight
	125 lbs to 168 lbs	18.5 to 24.9	Normal
	169 lbs to 202 lbs	25.0 to 29.9	Overweight
	203 lbs or more	30 or higher	Obese

Table 3-3. BMI Ranges and Weight Status Example

Use the following steps in determining the BMI.

1. To use the BMI function, weigh the patient as described under Weighing (above)3.1 and then press the **BMI** key. If weighing in Lbs, the default height of (5 feet) appears on the display. Use the up or down arrows to increase the feet height by one foot increments). Press the **BMI** key again to display inches (default is 7.0 inches) Again, use the up or down arrows to increase or decrease the inches height by 0.5" increments. Press the **BMI** key again to accept the inches value. The final height value will be displayed ie: 5-07.5 = 5' 7.5".
2. If you are weighing in Kgs, the default will be 170.0 cm. Use the up or down arrows to increase or decrease by 0.5 cm increments.
3. To see the patient's calculated BMI, press the **BMI** key again. The BMI appears.
4. To cancel the BMI display, press the **BMI** key.

3.3 Using the Tare Function

You can use the tare function for deducting an extra weight (such as a wheelchair, or medical equipment attached to the patient) in a weighing operation.

Use the following steps to use the tare function.

1. With the scale set to *0.0*, place the extra load on the scale. The display shows *WEIGH* and then the weight of the load.
2. Press and hold the **TARE** key until *TARE* appears on the display. The display returns to *0.0* and *TARE* appears on the left side of the display.
3. Remove the load from the scale. The weight of the load appears with a negative symbol to the left of it.
4. Ask the patient to step onto the scale with the load. The display then shows the patient's weight without the weight of the load.
5. The weight of the load remains stored in memory, so you can continue to weigh patients who are carrying the same tare weight. For example, when using the same wheelchair for weighing more than one patient.
6. To cancel the tare weight, press and hold the **TARE** key until *TARE* disappears from the display. The tare weight is also cancelled when the scale is turned off.

Use the following steps to enter a tare without placing that item on the scale. An example of this would be if you've got a patient in a wheelchair and the wheelchair has a known weight (has been tagged) you can enter that weight manually.

1. With the scale set to *0.0 Lbs* (there must be no weight on the scale), press the **TARE** key. The display will alternate between a value and the word *TARE*.
2. To change the value, press and hold the **Kg/Lb** key until the right most digit is equal to the first digit of the value you want. Example: If you want *103.5*, hold the key until the display is *0.1*.
3. To advance to the next digit, press the **Kg/Lb** key twice quickly. The digit you changed will move left and the right most digit will again be *0*. Again, hold the **Kg/Lb** key until the right most digit is equal to the next digit in the numbers you want.
4. Continue as in Step 3 until you are displaying the value you want, then press the **TARE** key.
5. You can now accurately weigh the patient.
6. To cancel the tare weight, press and hold the **TARE** key until *TARE* disappears from the display. The tare weight is also cancelled when the scale is turned off.

4.0 Scale Configuration

Options and parameter setup are done through the scale configuration section and is used for setting values and various parameters and options that are essential for the functioning of the system. Entry into this mode is possible only when the scale is turned off.

4.1 Enabling Configuration or Calibration Modes

Before the scale will enter either the Configuration or Calibration mode, the configuration enable jumper must be removed.

Access to that jumper is gained by removing the back cover of the indicator. Remove the four back cover retaining screws as shown on the left side of Figure 4-1. With the cover removed, the jumper can be seen sticking through the hole in the rear housing (shown in Figure 4-1 - right side). Remove that jumper to gain access to the configuration and calibration modes.

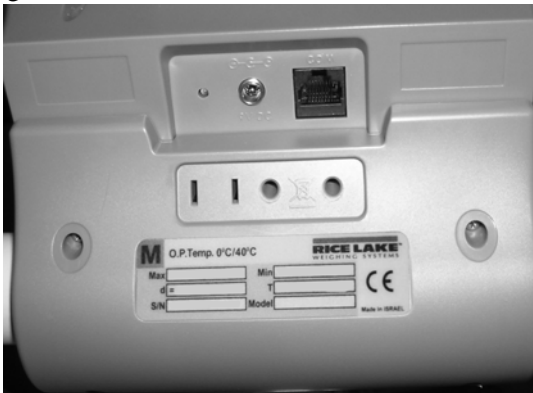

Remove retaining screws x 4 (only 2 shown)



Remove jumper to gain access to configuration and calibration modes

Figure 4-1. Gain Access to the Configuration/Calibration Enable Jumper on the Back of the Indicator

After configuration or calibration is done, the jumper must be replaced for normal scale operation.



Note A display of *Con En* indicates that the jumper is not in place. Put jumper on both pins to return the scale to normal weigh mode.

4.2 Configuration Mode

To get into the configuration mode, turn the scale off and remove the configuration jumper as shown in Figure 4-1. Turn the scale on. While *Start* is displayed, press and hold the **Kg-Lb** key until *IDENT* appears on the display.

To change from one parameter to the next, press the **REWEIGH** key once.

To change the value of the parameter, use the **Kg-Lb** key.

From the *SAVE* phase: to save the configuration data, press the **REWEIGH** key. *DONE* appears for one or two seconds followed by *Start* and the display enter into weighing mode and is ready to start the weighing process. To exit with saving changes, press the **Lb/Kg** key.

Various parameters can be set up while in programming mode.

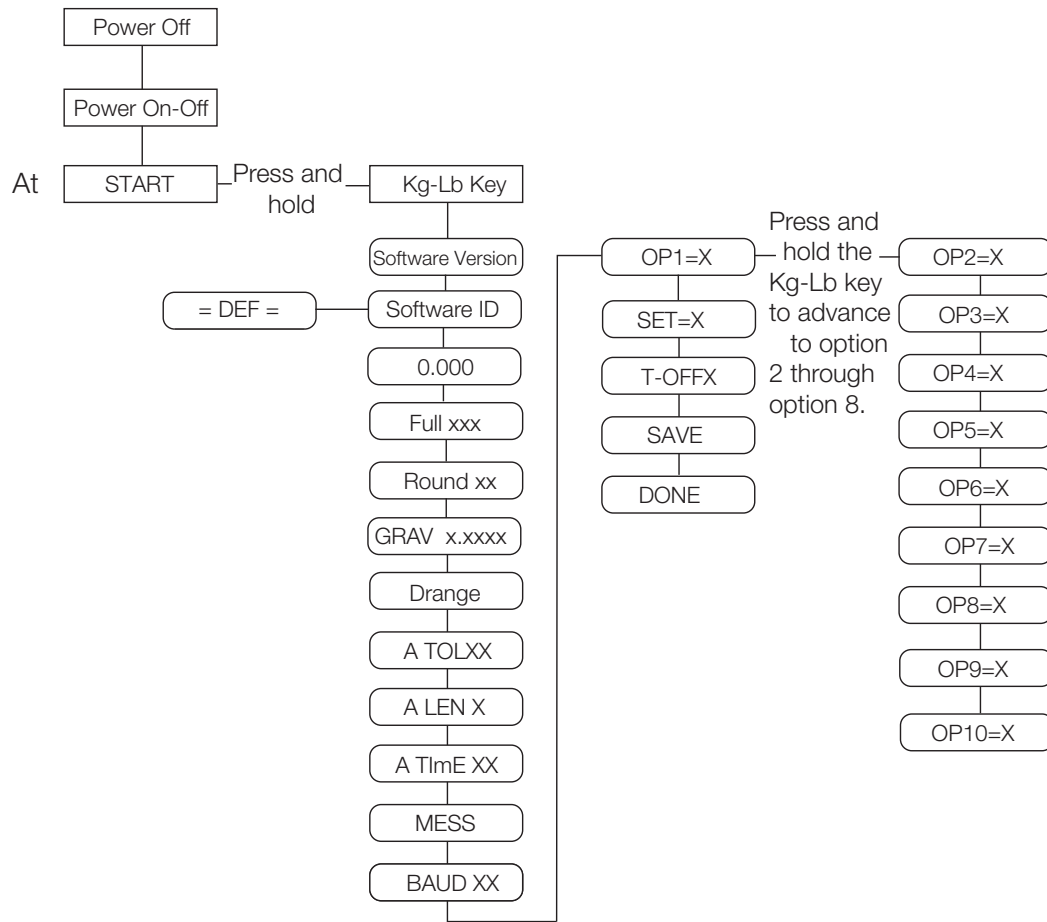

Figure 4-2. Programming Mode Menu Structure

4.3 Numeric Data Entry

Use the **Kg-Lb** key to change the numeric data entry while setting up the various configuration parameters and while in calibration mode.

Use the following steps:

1. Press and hold the **Kg-Lb** key, the rightmost digit on the display will begin to increment.
2. Release the **Kg-Lb** key to stop the increments.
3. A double click on the **Kg-Lb** key will cause the right hand digit to move one place to the left.
4. Repeat steps 1-3 until the desired number is reached.

The following table lists the various display messages and sequence when setting up the scale.



Note <-> means that you can toggle between two values.

Step		Function	Display	Available Parameters
1	With the scale turned off, remove the configuration jumper as shown in Figure 4-1.			Allows the scale to enter into either configuration or calibration mode.
2	With the scale turned off, simultaneously press the On-Off/Zero and Kg-Lb key.	Enters into programming mode	StArt	Scale automatically advances to Step 3.
3		Identifies the software ID	IdEnt<-> 11007	Press the REWEIGH key to advance to the next step.
4		Identifies software version	Id<->11387	Press the REWEIGH key to advance to the next step.
5		Allows selection of decimal point setting	dOt<->000.0 Default = 0.0	To change the position of the decimal point, press the Kg-Lb key to toggle through the various options. To advance to the next step, press the REWEIGH key.
6		This indicates the maximum allowed weight. Any weight above this value will cause <i>StOP</i> to appear on the display while in the weighing mode.	FULL<->XX.XXX Default= 600 Lb Note: This value is dependent on the model you have. Refer to the serial number label on your scale and set appropriately.	Use the numeric data entry (See "Numeric Data Entry" on page 8.) to change the value. To advance to the next step, press the REWEIGH key.
7		This limit defines the start of the weighing threshold to compensate for a key press during the Tare function.	Limit<->0.0	Use the numeric data entry (See "Numeric Data Entry" on page 8.) to see the optimum weight value of 5 lbs. To advance to the next step, press the REWEIGH key.
8		Display divisions	rOUnd<->XXXX Default = 0.2 Lb	To change the display divisions, press the Kg-Lb key to toggle through the various options. 0.2, 0.5, 1.0, 2.0, 5.0, 10.0, 20.0. To advance to the next step, press the REWEIGH key.
9		Double ranges limit	drAnGe <-> 0	This parameter is preset from the factory. To advance to the next step, press the REWEIGH key.
10		Weight algorithm initial tolerance	A tOL <-> 10	This parameter is preset from the factory. To advance to the next step, press the REWEIGH key.
11		Weight algorithm initial exponent	A LEn <-> 8	This parameter is preset from the factory. To advance to the next step, press the REWEIGH key.
12		Weight algorithm maximal exponent	A t INE <-> 10	This parameter is preset from the factory. To advance to the next step, press the REWEIGH key.

Table 4-1. Configuration Mode Menu

Step		Function	Display	Available Parameters
13		Message style on weight algorithm	MESS <-> WEIGH	This displays the message that will show on the indicator display. To change the message, press the Kg-Lb key. WEIGH, LIVE, ----- To advance to the next step, press the REWEIGH key.
14		This allows for setting the baud rate of the RS-232 connection	BAUd <-> Default - 9600	To change the baud rate, use the numeric data entry (See “Numeric Data Entry” on page 8.) To advance to the next step, press the REWEIGH key.
15		Optional features Option 1 allows the selection of unit of measure (UOM) in calibration and programming.	OP1 = 1	Hold the Kg-Lb key for browsing through the options. Double click on the Kg-Lb key to change the options value or to advance to the next step, press the REWEIGH key. OP1 = Unit of measure (UOM) in calibration and programming. 0=Kg 1=Lb
		Option 2 allows the scale to work only in Kg.	OP2 = 0	Hold the Kg-Lb key for browsing through the options. Double click on the Kg-Lb key to change the options value or to advance to the next step, press the REWEIGH key. 0=Disable 1= Enable This option works only if Option 3 is disabled
		Option 3 allows the scale to work only in Lb.	OP3 = 0	Hold the Kg-Lb key for browsing through the options. Double click on the Kg-Lb key to change the options value or to advance to the next step, press the REWEIGH key. 0=Disable 1=Enable
		Option 4, the scale must be stable to show a Kg or Lb weight reading. You can enable or disable this.	OP4 = 0	Hold the Kg-Lb key for browsing through the options. Double click on the Kg-Lb key to change the options value or to advance to the next step, press the REWEIGH key. 0=Disable 1=Enable Note: <i>won't show lb or kg until the scale is at a standstill.</i>

Table 4-1. Configuration Mode Menu

Step	Function	Display	Available Parameters
	Option 5 allows for live or dynamic weighing	OP5 = 0	Hold the Kg-Lb key for browsing through the options. Double click on the Kg-Lb key to change the options value or to advance to the next step, press the REWEIGH key. 0=Disable 1=Enable
	Option 6 allows you to either enable or disable the hold function on the scale	OP6 = 1	Hold the Kg-Lb key for browsing through the options. Double click on the Kg-Lb key to change the options value or to advance to the next step, press the REWEIGH key. 0=Disable 1=Enable
	Option 7 allows you to either enable or disable the baby scale function.	OP7= 0	Hold the Kg-Lb key for browsing through the options. Double click on the Kg-Lb key to change the options value or to advance to the next step, press the REWEIGH key. 0=Disable 1=Enable Note: Leave set to 0
	Option 8 allows you to choose between 9 volts and 6 volts	OP8 = 1	Hold the Kg-Lb key for browsing through the options. Double click on the Kg-Lb key to change the options value or to advance to the next step, press the REWEIGH key. 0=9 volts 1=6 volts Note: Leave set to 1
	Option 9 allows you to select the communications protocol.	OP9 = 1	Hold the Kg-Lb key for browsing through the options. Double click on the Kg-Lb key to change the options value or to advance to the next step, press the REWEIGH key. 0= escape 1= standard protocol
	Option 10 allows you to enable the user menu.	OP10 = 1	Hold the Kg-Lb key for browsing through the options. Double click on the Kg-Lb key to change the options value or to advance to the next step, press the REWEIGH key. 0= enable 1= disable

Table 4-1. Configuration Mode Menu

Step		Function	Display	Available Parameters
16		Set Option defaults	Set < - > 1	To change, press the Kg-Lb key. 0 - default Options = (OPx) 1 = US default (US defaults are OP1-1, OP2-0, OP3-0, OP4-0, OP5-0, OP6-1, OP-7-0, OP8-1, OP9-1, OP10-1). 2 = European 1 default 3 = European 2 default 9 = Used if OP1 through OP10 have been changed to something other than the factory default settings. Note: Always set to 1 or 9 for US indicators. To advance to the next step, press the REWEIGH key.
17		Determines the automatic shut off time when the scale is not in use. Options are between one and 20 minutes. This is used when the unit is battery operated.	t-OFF <-> 5	Press and hold the Kg-Lb key to scroll through the furthest right hand digit on the display (0-9). If you want a value from 10 to 19, with the display sitting at 1, double press the Kg-Lb key and 10 appears. Press and hold the Kg-Lb key to begin scrolling 10-19. If you want a value of 20, with the display sitting at 2, double press the Kg-Lb key and 20 will appear. To advance to the next step, press the REWEIGH key.
18			StArt or SAve	If no changes were made in the parameters the display will automatically show <i>StArt</i> and then returns to normal weighing mode. If a parameter was changed, the display will show <i>SAve</i> . To save changes made, press the REWEIGH key. To return to weigh mode without saving changes, press the Kg-Lb key.
19			Con En	Replace the configuration jumper.

Table 4-1. Configuration Mode Menu

4.4 Reset To Factory Defaults

The configuration parameters may be reset to factory defaults while in the configuration mode. To do so, enter the configuration mode. Press the **REWEIGH** key once to advance to displaying the software version (ID <-> 11305). Press and hold the **BMI** key until =DEF= is displayed. At this point, if you wish to perform the default function, press the **REWEIGH** key and the scale will show *DONE*, then it will restart. If you do not want to perform the default function, press the **ON/OFF** key.

After performing the default function, the scale will require re-calibration. In addition, the scale will be set up to a capacity of 600 lbs. The capacity varies by model - refer to the serial label on your scale and reconfigure the capacity (FULL) and display divisions (rOUNd) as necessary in the configuration menu.

5.0 Scale Calibration

Before you can calibrate the scale, verify and set all scale parameters which are noted in “Scale Operation” on page 4.

Remove the configuration/calibration jumper (see page 7). Turn the scale on. While *StArt* is displayed, press and hold both the **Kg-Lb** key and the **REWEIGH** keys until *CAL* is displayed.

To do a calibration on the scale, the scale must be turned off.



Note *The calibration weight must be no less than 60 lb (28 kg) and no more than 300 lb (135 kg).*

The following chart illustrates the calibration procedure.

Step		Function	Display	Available Parameters
1	Turn the scale on. While <i>START</i> is displayed, press and hold the Kg-Lb and REWEIGH keys until <i>CAL</i> is displayed.	Enters into calibration mode	StArt	The scale automatically advances to Step 2.
2		Cal mode entered	CAL	To advance to the next step, press the REWEIGH key.
3		Sets the value of the calibration weight you are going to use for calibrating the span value of the scale.	LOAd <-> XXX.X	Use the numeric data entry (explained in “Numeric Data Entry” on page 8) to set a calibration weight. To advance to the next step, press the REWEIGH key.
4			CLEAR	Clear the platform and be sure of the scale’s stability. To advance to the next step, press the REWEIGH key.
5	Calibrate Zero		----- PUT<->XXXX	Place the requested weight on the scale. This will display for a few seconds. To advance to the next step, press the REWEIGH key.
6	Calibrate Span		CAL FAC tOr <-> X.XXX	This will be displayed for a few seconds and shows the current calibration factor. To advance to the next step, press the REWEIGH key.
7			SAvE	To save the new calibration, press the REWEIGH key. To exit without saving the calibration press the ZERO key.
8			dONE	The scale displays that it has saved that calibration value and automatically advances to the last step.
9			StArt	The scale reboots.
10			Con En	Replace the configuration jumper.

Table 5-1. Calibration Menu

6.0 RS-232 Communication

The scale comes with an RS-232 port which enables weight data to be transmitted to other equipment, such as a computer or printer. The RS-232 cable with DB-9 connector (PN 100719) is available from Rice Lake Weighing System. Figure 2-2 on page 3 shows where the RS-232 connection is.

The RS-232 parameters are 9600 baud (selectable in the programming mode), 8 data bits, 1 stop bit, no parity and no handshaking.

There are three methods of communication:

- Pushbutton keypad print
- Standard remote protocol
- Escape protocol

6.1 Pushbutton Keypad Print

With a stable, in-range weight, press and hold the **Kg-Lb/Print** key for at least three seconds, or until the scale emits two quick beeps. Note that if the scale does not beep after five seconds, then release the button as the weight was either in motion, or out of range.

- If displaying weight and not BMI, the scale will send out the following 21 character string:

```
xxxxxxxx<SP>uu<SP>mmmm<SP><CR><LF>
```

Where:

xxxxxxxx is the weight with decimal point and " - " sign, if negative uu is the unit (lb or kg).

mmmm is the mode (gross or net)

Examples:

```
-10 Lb net = <SP><SP><SP><SP>-10.0<SP>lb<SP><SP>Net<SP><SP><SP><CR><LF>
```

```
10 Lb gross = <SP><SP><SP><SP><SP>-10.0<SP>lb<SP>Gross<SP><CR><LF>
```

- In BMI mode (displaying the BMI value), the scale will send out the following data:

```
GROSS WEIGHT    215.0 LB
TARE WEIGHT      0.0 LB
NET WEIGHT       215.0 LB
PATIENT HEIGHT  6-01.0 FT
PATIENT BMI      28.4
```

6.2 Standard Remote Protocol (configuration option #9 set to 1)

When connected to a computer, there are five commands that can be used in the standard remote protocol to communicate with the scale. They are:

- t - tare the scale. If in gross mode, will tare and go to net mode. If in net mode, will remove tare and return to gross mode.
- w - the scale sends the actual weight to the computer.
- i - the scale sends the software ID of the scale.
- z - the scale will be set to zero (0.0) if possible.
- p - the scale sends the same data as a pushbutton keypad print.

The format of the returned data will be the same as noted under the pushbutton keypad print. Note that the w and p commands will not return a value if the scale is in motion, or displaying an invalid weight.

6.3 ESC Protocol (configuration option #9 set to 0)

The ESC Protocol differs from the standard protocol and enables weight and unit of measure data to be transmitted for full integration into electronic medical records or for diagnostic testing of the battery life, load cells, etc. The scale will only transmit data upon receiving the proper command set.

You can test the command set and review the scales' response using either PROCOMM Plus or the Dietary/Fitness files found on our web site, www.ricelake.com/health. If using PROCOMM Plus, we recommend you set up "hot" keys for the commands. Refer to Table 6-1 for a listing of those commands.

An Escape Protocol is where the escape <ESC> is used to indicate that there is a command following and not just data.

Table 6-1 lists a complete list of ESC commands that are used with the scale.

Command/Response	ESC Character	ESC value with Parameters	Description
Reading	R	R	This value tells the PC that the scale is sending a reading. Immediately following this will be the value that is sent Example: <ESC>R<ESC>E <ESC>R<ESC>W0200.5<ESC>Nm<ESC>E
Weight	W	Wnnn.n	This is the patient's weight (ie: W0200.5 means 200.5 lb). If the scale is overloaded, the scale will return the value of 999.9.
Units	N	Nc	This indicates in which unit the values have been taken (m=metric, c=constititutional)
End of Packet (EOP)	E	E	This indicates that the end of the command/data packet has been reached
Diagnostics (request)	A	Accc	This is the request for a diagnostic test on certain parts of the scale such as the battery life, loadcells, etc. <ul style="list-style-type: none"> • AD value (ADC) = E06=AD is too high, E07=AD is too low • Overload (OVL) = E10 • Battery (BAT) = E4U= (Bat ok) or E4L (Bat Low, but still usable - 1 bar left on the indicator) • Calibration information OK (CAL) = E11=Calibration was not okay and the user needs to recalibrate.
Diagnostics (response)	Z	Zccc	This will be the response to the diagnostics done on the scale. Values will include any error codes to indicate what is wrong with the scale, or all zeros (Z000) to indicate that all is well.
Control (set a value)	C	Cccc=c	This is to set the value of the scale's global settings <ESC>CUOM=m<ESC>E will set the unit of measurement to KG <ul style="list-style-type: none"> • Unit of measurement (metric or constitutional) (UOM) = c (m or c)

Table 6-1. RS-232 Communication Parameters

If you're using the Rice Lake files, please follow the instructions below.

1. Go to www.ricelake.com/health and download the Rswin.exe and Inbar.ini files located in the downloads section of the web site and download them to your computer.
2. Ensure that the scale is connected to the computer via RS-232 cable.

3. Double click on the Rswin.exe file and the following screen appears.

Click on FILES and in dropdown menu, select LOAD CONFIGURATION as noted in Step 4

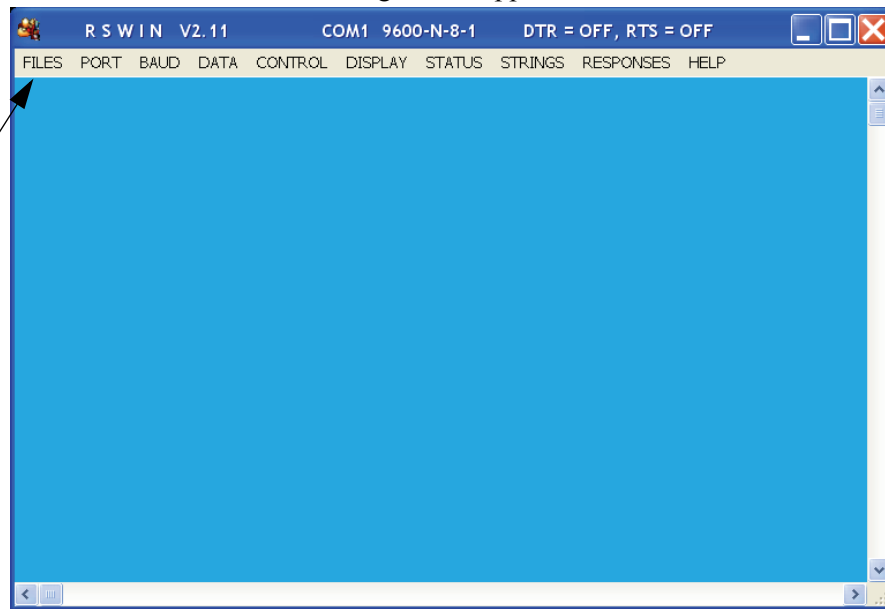

Figure 6-1. Rswin Screen

4. Click on *FILES* and in the dropdown menu, select *LOAD CONFIGURATION*. At this time double click on the file, Inbar.ini.
5. Click on *STRINGS* and the following screen appears.

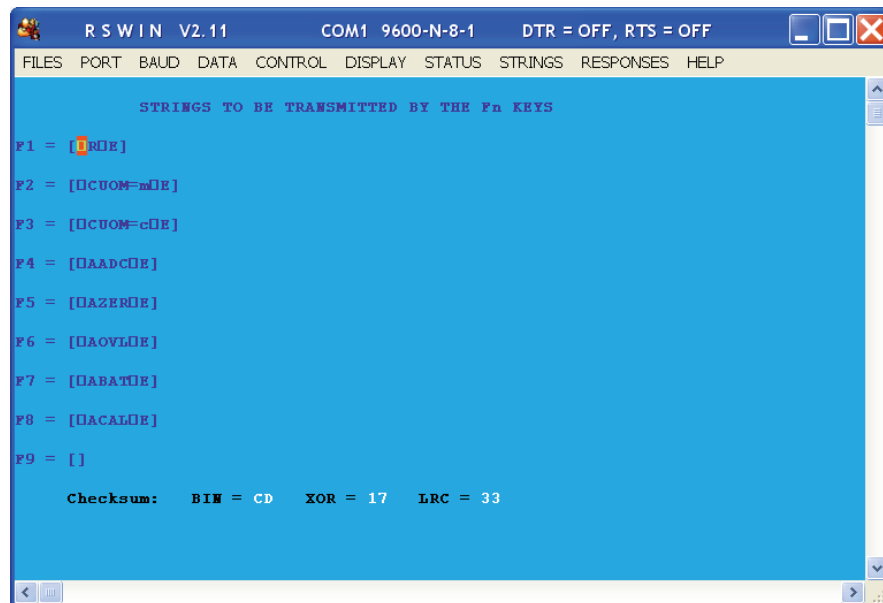

Figure 6-2. Strings to be Used in the RS-232 Transmission

This screen is showing that the function keys are already pre-programmed with command sets. For example, pressing the **F1** key is the same as sending <ESC>R<ESC>E.

6. Click on *DISPLAY* and in the drop down menu, select either *HEX* or *ASCII*.

Examples of what you would see in the HEX screen are shown in Figure 6-3.

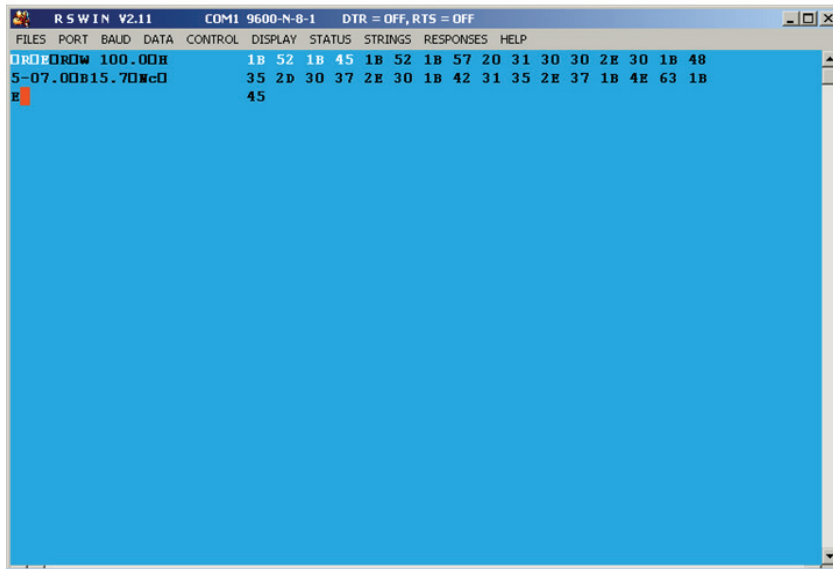

Figure 6-3. HEX Screen Example

Examples of what you would see in the ASCII screen are shown in Figure 6-4.

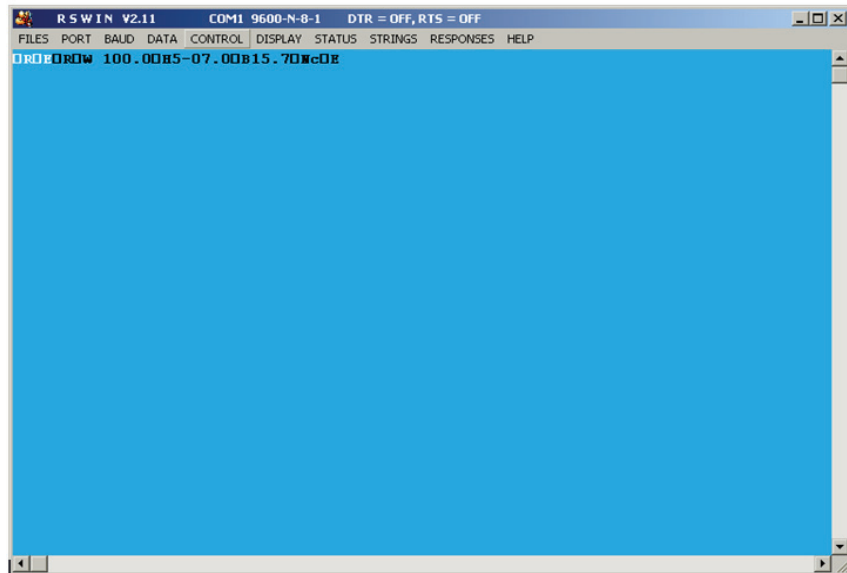
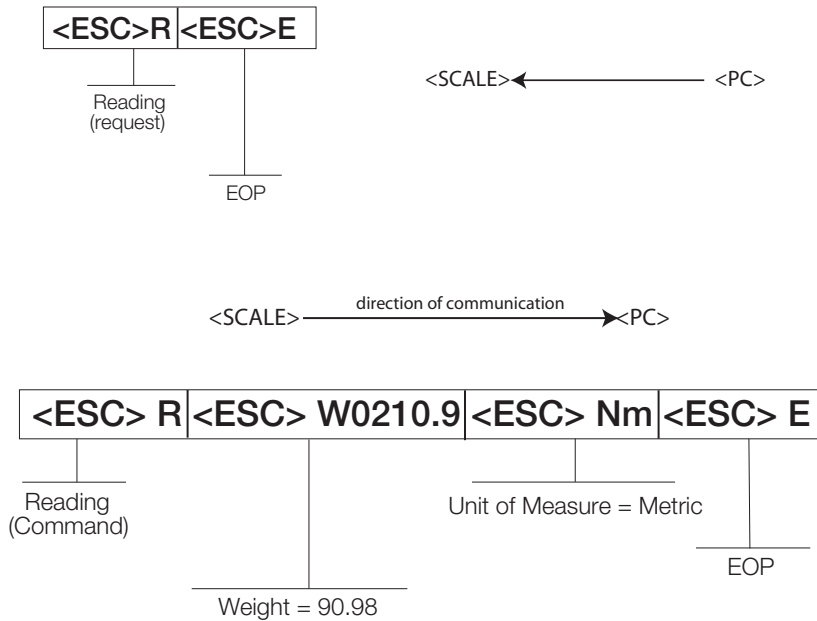

Figure 6-4. ASCII Screen Example

6.4 Sample and Explanation of ESC Protocol

When the scale measures weight and sends this over the communications line to the PC, the string will look like this.

<SCALE> -----<PC>



When the user wants to diagnose any problems with the scale, the operator will have to ask the scale to send the error data (if any exists). This is done with the Diagnostics (request) command and will look like this:

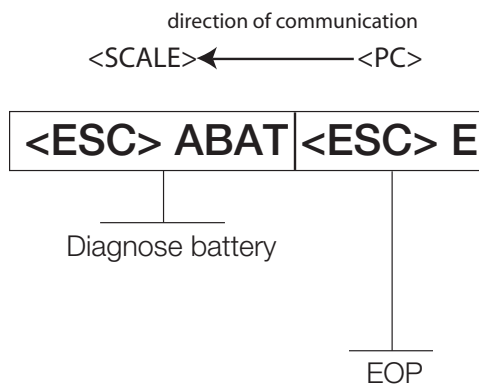

If the battery is okay, the scale will reply with the following value:

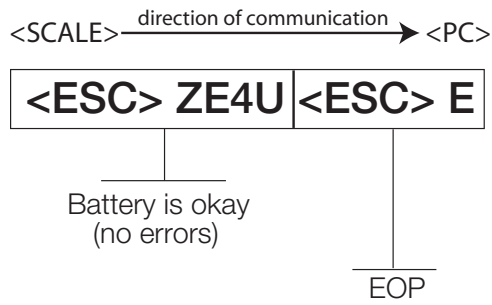

If the battery is critically low, it will reply with:

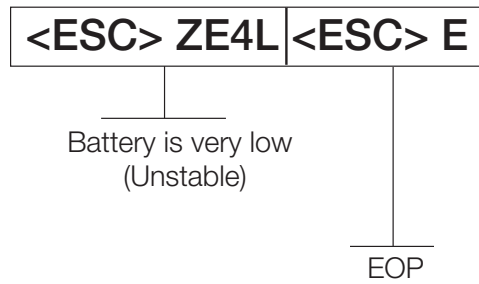

7.0 Troubleshooting and Testing

Refer to the following instructions to check and correct any failure before contacting service personnel.

Symptom	Possible Cause	Corrective Action
Scale does not turn on	Dead battery	Connect the scale to a power source.
	Faulty electrical outlet	Use a different electrical outlet.
	Bad power supply	Replace adaptor.
Questionable weight or the scale does not zero	External object is interfering with the scale	Remove the interfering object from the scale.
	Display did not show 0.0 before weighing	Help the patient off the scale, zero the scale and begin the weighing process again.
	Scale is not placed on a level floor	Ensure the scale is level using the spirit level on the platform and begin the weighing process again.
	Scale is out of calibration	Check the weight with a known weight value.
	Improper tare	Place the patient on the scale. Press REWEIGH . Once the weight of the item is displayed, press TARE . Place the patient back on the scale. Press the REWEIGH button again.
Weighing is performed but the display shows <i>WEIGH</i> and <i>REWEIGH</i> every few seconds; the weighing process takes too long and no weight is displayed	The patient is not sitting still	Ask the patient to be still.
The display shows a <i>STOP</i> message	The load on the scale exceeds the capacity of the scale (220 kg)	Remove the excess weight and use the scale according to manufacture's specs.
The display shows <i>LO Bat</i> message	The battery is low	Recharge the battery.
The display shows Err message as detailed in the table below		
Err 2	Low saturation state (low A/D)	The load cell is not connected properly. Check the cables and mechanical connections. If the problem persists, replace the set of load cells.
Err 3	High saturation state (high A/D)	See Err 2
Err 6	Unstable weight. Cannot calibrate	Check the load cells' mechanical surroundings and see that nothing touches them and that the cables are properly welded.
Err 7	Mathematical error; division by zero. Cannot calculate calibration factor.	This error will show when trying to calibrate the unit with no calibration weight on the unit.
Calibration or configuration settings are messed up	Pushed the wrong keys	Reset to factory defaults. See page 12 for instructions.

Table 7-1. Troubleshooting Table for the Rice Lake Scale Line

7.1 Test Mode

The test mode menu is a special mode used for checking four very important parameters which are useful in knowing the system's state and for troubleshooting. Entry into this mode is possible only when the scale is turned off. Turn the scale on. While *Start* is displayed, press and hold the **REWEIGH** key until both the middle arrows appear on the display.

The test mode has four parameters. They are:

- Weighing
- Internal count
- Battery indication
- Calibration factor

Alternating between the parameters is performed by pressing the **REWEIGH** key.

Press the **Kg-Lb** key to zero the scale in test mode.

Press the **Kg-Lb** + **REWEIGH** to exit weighing mode.

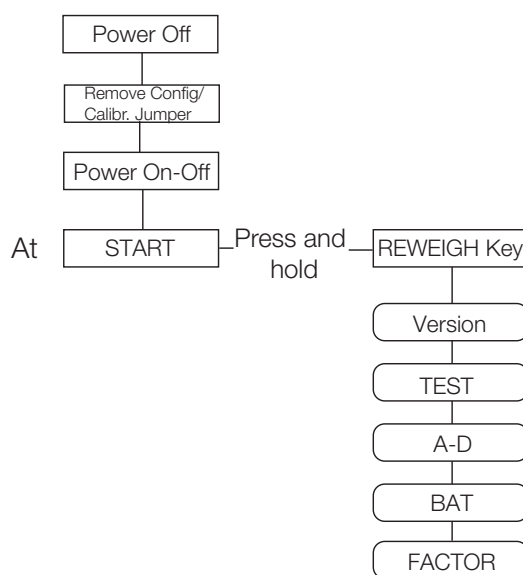

Figure 7-1. Test Mode Menu Structure

Table 7-2 lists the various display messages when testing the scale.



Note <-> means that you can toggle between the two values.

Step		Function	Display	Available Parameters
1	With the scale turned off, simultaneously press the REWEIGH and On-Off/Zero keys.	This enters into the test mode of the scale.	StArt	The scale automatically advances to Step 2.
2		Identifies the software ID	IdEnt <-> 11007	Press the REWEIGH key to advance to the next step.
3		Shows the current weight value	tEst <-> 0.0	To advance to the next step, press the REWEIGH key.
4		Shows the current A/D count	A-d <-> XXXX	To advance to the next step, press the REWEIGH key.

Table 7-2. Test Mode Menu

Step	Function	Display	Available Parameters
5	Checks for current battery level	bAt <-> XXX or nO bAt	If the <i>nO bAt</i> is displayed, there are not batteries in the unit or the unit is operating on its external AC adaptor. To advance to the next step, press the REWEIGH key.
6	This shows the calibration factor	FAcTOr <-> XXXXX	Press the REWEIGH key to return to the top of the test menu. To exit test mode, press the REWEIGH and Kg-Lb key simultaneously, or turn off the indicator.

Table 7-2. Test Mode Menu

8.0 Maintenance

The following section provides instructions for maintaining and cleaning the Rice Lake line of scales. Maintenance operations other than those described in this section should be performed by qualified service personnel.

8.1 Basic Maintenance

Before the first use of the scale and after periods of non-use, check the scale for proper operation and function. If the scale does not operate correctly, contact qualified service personnel.

Go through the following steps for basic maintenance.

1. Check the overall appearance of the entire scale for any obvious signs of damage, abuse, etc.
2. Inspect the condition of the AC adaptor for cord cracking or fraying or for broken or bent prongs.

8.2 Cleaning

Proper care and cleaning is essential to ensure a long life of accurate and effective operation. Before beginning the cleaning process, disconnect the scale from the AC power source.

1. Clean all external surfaces with a clean, damp cloth or tissue. Mild soap and water solution may be used. Dry with a clean soft cloth.
2. Do not immerse the scale into cleaning or other liquid solutions.
3. Do not use Isopropyl alcohol or other solutions to clean the display surface.

9.0 Digital Physician Scale Specifications

Power

120 VAC-9VDC-60Hz / 230 VAC-9VDC-50Hz

Battery Type

Sealed lead acid battery

Battery Use

75 hours

Automatic power-off can be configured

Data Communications

RS-232 with RJ-45 jack

Selectable baud rate, default - 9600

8 bits

No parity

1 stop bit

No handshaking

Environmental

Operating Temperature

50 to +104°F (14 to 40°C)

Storage Temperature

32 to 158°F (0 to 70°C)

Humidity

85% relative humidity

Capacity and Graduation

Digital Physician Scale

550lb (250kg) 0.2lb (100g)

Certifications and Approvals

RoHS Compliant

Dimensions

Eye-Level Physician Scale

Height measuring rod measures from 35 in to 82 in x 1/8
in (90 cm to 209 cm x 1 mm)

Waist-Level Physician Scale

Integrated wheels for ease of portability

Floor-Level Physician Scale

6.5 ft cable between scale base and indicator

Platform Dimensions

14.5 in W x 14 in L x 3 in H

For More Information

System Manuals

- *Digital Physician Scale Operation Instructions*, PN 113684

Literature

- *Medical Scales, Physician Scales, 4 Color*, PN 106424

Web Site

- <http://www.ricelake.com/health>

Contact Information

Hours of Operation

Knowledgeable customer service representatives are available 6:30 a.m. - 6:30 p.m. Monday through Friday and 8 a.m. to 12 noon on Saturday. (CST)

Telephone

- Sales/Technical Support 800-472-6703
- Canadian and Mexican Customers 800-321-6703
- International 715-234-9171

Immediate/Emergency Service

For immediate assistance call toll-free 1-800-472-6703 (Canadian and Mexican customers please call 1-800-321-6703). If you are calling after standard business hours and have an urgent scale outage or emergency, press 1 to reach on-call personnel.

Fax

Fax Number 715-234-6967

Email

- US sales and product information at prodinfo@ricelake.com
- International (non-US) sales and product information at intlsales@ricelake.com

Mailing Address

Rice Lake Weighing Systems
230 West Coleman Street
Rice Lake, WI 54868 USA

Digital Physician Scale Limited Warranty

Rice Lake Weighing Systems (RLWS) warrants that all RLWS equipment and systems properly installed by a Distributor or Original Equipment Manufacturer (OEM) will operate per written specifications as confirmed by the Distributor/OEM and accepted by RLWS. All systems and components are warranted against defects in materials and workmanship for two years.

RLWS warrants that the equipment sold hereunder will conform to the current written specifications authorized by RLWS. RLWS warrants the equipment against faulty workmanship and defective materials. If any equipment fails to conform to these warranties, RLWS will, at its option, repair or replace such goods returned within the warranty period subject to the following conditions:

- Upon discovery by Buyer of such nonconformity, RLWS will be given prompt written notice with a detailed explanation of the alleged deficiencies.
- Individual electronic components returned to RLWS for warranty purposes must be packaged to prevent electrostatic discharge (ESD) damage in shipment. Packaging requirements are listed in a publication, *Protecting Your Components From Static Damage in Shipment*, available from RLWS Equipment Return Department.
- Examination of such equipment by RLWS confirms that the nonconformity actually exists, and was not caused by accident, misuse, neglect, alteration, improper installation, improper repair or improper testing; RLWS shall be the sole judge of all alleged non-conformities.
- Such equipment has not been modified, altered, or changed by any person other than RLWS or its duly authorized repair agents.
- RLWS will have a reasonable time to repair or replace the defective equipment. Buyer is responsible for shipping charges both ways.
- In no event will RLWS be responsible for travel time or on-location repairs, including assembly or disassembly of equipment, nor will RLWS be liable for the cost of any repairs made by others.

THESE WARRANTIES EXCLUDE ALL OTHER WARRANTIES, EXPRESSED OR IMPLIED, INCLUDING WITHOUT LIMITATION WARRANTIES OF MERCHANTABILITY OR FITNESS FOR A PARTICULAR PURPOSE. NEITHER RLWS NOR DISTRIBUTOR WILL, IN ANY EVENT, BE LIABLE FOR INCIDENTAL OR CONSEQUENTIAL DAMAGES.

RLWS AND BUYER AGREE THAT RLWS'S SOLE AND EXCLUSIVE LIABILITY HEREUNDER IS LIMITED TO REPAIR OR REPLACEMENT OF SUCH GOODS. IN ACCEPTING THIS WARRANTY, THE BUYER WAIVES ANY AND ALL OTHER CLAIMS TO WARRANTY.

SHOULD THE SELLER BE OTHER THAN RLWS, THE BUYER AGREES TO LOOK ONLY TO THE SELLER FOR WARRANTY CLAIMS.

NO TERMS, CONDITIONS, UNDERSTANDING, OR AGREEMENTS PURPORTING TO MODIFY THE TERMS OF THIS WARRANTY SHALL HAVE ANY LEGAL EFFECT UNLESS MADE IN WRITING AND SIGNED BY A CORPORATE OFFICER OF RLWS AND THE BUYER.

© 2010 Rice Lake Weighing Systems, Inc. Rice Lake, WI USA. All Rights Reserved.

RICE LAKE WEIGHING SYSTEMS • 230 WEST COLEMAN STREET • RICE LAKE, WISCONSIN 54868 • USA



230 W. Coleman St. • Rice Lake, WI 54868 • USA
U.S. 800-472-6703 • Canada/Mexico 800-321-6703
International 715-234-9171

www.ricelake.com
[mobile: m.ricelake.com](http://m.ricelake.com)

© 2010 Rice Lake Weighing Systems

PN 118603 10/11