

MSI-3460

Challenger 3

Technical Manual



© Rice Lake Weighing Systems. All rights reserved.

Rice Lake Weighing Systems® is a registered trademark of
Rice Lake Weighing Systems.

All other brand or product names within this publication are trademarks or
registered trademarks of their respective companies.

All information contained within this publication is, to the best of our knowledge, complete and
accurate at the time of publication. Rice Lake Weighing Systems reserves the right to make
changes to the technology, features, specifications and design of the equipment without notice.

The most current version of this publication, software, firmware and all other product
updates can be found on our website:

www.ricelake.com

Revision History

This section tracks and describes manual revisions for awareness of major updates.

Revision	Date	Description
A	February 14, 2023	Initial manual release with product launch

Table i. Revision Letter History



Technical training seminars are available through Rice Lake Weighing Systems. Course descriptions and dates can be viewed at www.ricelake.com/training or obtained by calling 715-234-9171 and asking for the training department.

Contents

1.0	Introduction	7
1.1	Features	7
1.2	Options	7
1.3	Safety	8
1.4	FCC Compliance	9
1.5	Storage	9
1.6	MSI-3460 Front Panel	10
2.0	Operation	11
2.1	Power	11
2.2	Zero	11
2.3	Tare	12
2.3.1	View Tare	12
2.3.2	Clear Tare	12
3.0	Installation	13
3.1	Unpacking	13
3.2	Assembly	13
3.3	Battery Pack	14
3.4	Battery Charger	15
4.0	Setup	16
4.1	Setup Menu	16
4.2	Set Function Key	17
4.2.1	Test	17
4.2.2	Total	18
4.2.3	View Total	18
4.2.4	NET / GROSS	18
4.2.5	Peak Hold	18
4.2.6	Units	18
4.2.7	High Resolution Test Mode	19
4.2.8	Print	19
4.3	Auto-Off	19
4.4	Sleep	19
4.5	Display Brightness	20
4.6	Display Color	20
4.7	Setpoints	21
4.8	Total Mode	22
4.9	Filter Setup	23
4.10	Unit	23
4.11	Battery Life	23
5.0	Calibration	24
5.1	Calibration Switch Access	24
5.2	Standard Calibration	25
5.3	Initial Calibration	26
5.4	Guidelines for Capacity and Resolution	27
5.5	Constant Calibration (C-Cal)	27
5.6	Standard Menu	28



Rice Lake continually offers web-based video training on a growing selection of product-related topics at no cost. Visit www.ricelake.com/webinars

5.7	Auto Zero Maintenance (AZM)	29
5.8	Zero Power Up (0.P-UP)	29
5.9	Filter	30
5.10	Gravity Compensation	30
5.10.1	Compensation by Latitudes and Elevations	31
5.10.2	Compensation by Gravity Factor	31
6.0	Communications	32
6.1	Printer / Serial Output Setup	32
6.1.1	Standard Print Strings	32
6.1.2	Control Modes	33
6.1.3	Printer Output Setup	34
6.2	RF Network Setup	35
6.2.1	802.15.4 RF Network Setup	35
6.2.2	Hold Feature	36
6.3	Radio Compliance	37
6.3.1	802.15.4 (XBee 3 and XBee 3-PRO)	37
6.3.2	802.15.4 (XBee 2SC)	37
6.3.3	Wi-Fi	37
6.3.4	Bluetooth®	38
6.3.5	FHSS (Frequency Hopper Spread Spectrum)	38
7.0	Optional Rugged Remote	39
7.1	Operation	39
7.1.1	Power	40
7.1.2	Zero	40
7.1.3	Tare	40
7.1.4	Programmable Function Keys	40
7.2	Conflict and Jamming Considerations	40
7.3	FCC Compliance	40
8.0	Maintenance	41
8.1	Troubleshooting	41
8.2	Service Counters	42
8.3	Software Update	43
8.4	MSI-3460 Challenger 3 Dimensions	46
9.0	Specifications	47



Technical training seminars are available through Rice Lake Weighing Systems. Course descriptions and dates can be viewed at www.ricelake.com/training or obtained by calling 715-234-9171 and asking for the training department.



Rice Lake continually offers web-based video training on a growing selection of product-related topics at no cost. Visit www.ricelake.com/webinars

1.0 Introduction

The MSI-3460 Challenger 3 is a combination of the sound and proven mechanical design of the industry standard Challenger with today's most advanced electronics. It provides a superb feature set unmatched by any scale in its class or price range. The multi-purpose hanging scale is ideal for situations in which headroom is at a minimum. The MSI-3460 is versatile, reliable, accurate and easy to operate. The MSI-3460 is designed to meet or exceed the requirements of all regulatory agencies. RF remote control and remote display options are available to further enhance the safety and usability of the MSI-3460.



Manuals and additional resources are available from the Rice Lake Weighing Systems website at www.ricelake.com

Warranty information can be found on the website at www.ricelake.com/warranties

1.1 Features

- Meets or exceeds U.S. and international safety and environmental standards.
- Provides up to 50 hours of weighing time when utilizing automatic sleep mode .
- Automatic power off conserves battery life by turning off after sensing no activity during set amount of time.
- Automatic sleep mode preserves the battery life by dimming the LED display after a set number of minutes of no activity
- Rugged construction throughout. Buttons are sealed and rated for over one million operations.
- Precise high resolution (2,500-division standard and up to 10,000 possible) 24 bit A/D conversion coupled with advanced RISC micro controller provides world class features and accuracy.
- Five large, 1.5 in (38 mm) LED digits displayed in red, green or orange for clear weight reading from a distance.
- Easy digital calibration assures reliable, repeatable measurements; Calibration can be performed without test weights using C-Cal technology.
- Selectable for lb/kg unless prohibited by Legal for Trade regulations.
- Automatic or manual weight totalization for loading operations.
- Easily customized for special applications.
- High-speed PEAK mode for wire and rope stress analysis.
- Three setpoints can be set for any in-range weight for operator alerts or process control.
- ScaleCore™ technology provides quick and easy software updates and backup for calibration and setup.
- Two service counters ensure load train safety by warning the user to perform a load train safety check when the lift count gets high or the scale has been overloaded repeatedly.

1.2 Options

- RF remote controller
- RF modem for connectivity to MSI-8000 RF Remote Display and/or remote receiver model MSI-7000/1 RF Receiver and Remote Scoreboard
- MSI-8000 RF Display
- MSI-8004 HD Remote Display
- 85-265 VAC input power
- Audible alarm (triggered by setpoint 1)

1.3 Safety

Safety Definitions:



DANGER: Indicates an imminently hazardous situation that, if not avoided, will result in death or serious injury. Includes hazards that are exposed when guards are removed.



WARNING: Indicates a potentially hazardous situation that, if not avoided, could result in serious injury or death. Includes hazards that are exposed when guards are removed.



CAUTION: Indicates a potentially hazardous situation that, if not avoided, could result in minor or moderate injury.



IMPORTANT: Indicates information about procedures that, if not observed, could result in damage to equipment or corruption to and loss of data.

General Safety



Do not operate or work on this equipment unless this manual has been read and all instructions are understood. Failure to follow the instructions or heed the warnings could result in injury or death. Contact any Rice Lake Weighing Systems dealer for replacement manuals.



WARNING

Failure to heed could result in serious injury or death.

Do not allow minors (children) or inexperienced persons to operate this unit.

Do not stand near the load being lifted as it is a potential falling hazard. Keep a safe distance.

Do not use for purposes other than weight taking or dynamic load monitoring.

Do not use any load bearing component that is worn beyond 5% of the original dimension.

Do not use the scale if any of the components of the load train are cracked, deformed or show signs of fatigue.

Do not exceed the rated load limit of the scale, rigging elements or the lifting structure.

Do not use in hazardous environments including, but not limited to, explosive, acidic, alkaline or saline environments.

Do not handle dangerous goods including, but not limited to, molten masses or radioactive materials.

Do not allow multi-point contact with the hook, shackle or lifting eye of the scale.

Do not allow high torque on the scale unless it is specifically designed for high torque.

Do not make alterations or modifications to the scale or associated load bearing devices.

Do not use improperly rated or sized shackles. Use only MSI recommended shackles.

Do not remove or obscure warning labels.

Do not use solvents or aggressive substances to clean the scale.

Do not submerge.

For guidelines on the safe rigging and loading of overhead scales and dynamometers, read the MSI Crane Scale Safety and Periodic Maintenance Manual (PN 153105).

Keep hands, feet and loose clothing away from moving parts.

There are no user-serviceable parts within the MSI-3460. Any repairs are to be performed by qualified service personnel only.

Close proximity to audible alarm for sustained periods of time could be hazardous. Hearing protection may be required.

1.4 FCC Compliance

United States

This equipment has been tested and found to comply with the limits for a Class A digital device, pursuant to Part 15 of the FCC Rules. These limits are designed to provide reasonable protection against harmful interference when the equipment is operated in a commercial environment. This equipment generates, uses, and can radiate radio frequency energy and, if not installed and used in accordance with the instruction manual, may cause harmful interference to radio communications. Operation of this equipment in a residential area is likely to cause harmful interference in which case the user will be required to correct the interference at his own expense.

Canada

This digital apparatus does not exceed the Class A limits for radio noise emissions from digital apparatus set out in the Radio Interference Regulations of the Canadian Department of Communications.

Le présent appareil numérique n'émet pas de bruits radioélectriques dépassant les limites applicables aux appareils numériques de la Class A prescrites dans le Règlement sur le brouillage radioélectrique édicté par le ministère des Communications du Canada.

1.5 Storage

The MSI-3460 must be kept stable during storage. Storage is stable if the unit is in its original packaging, if it is hanging from the upper attachment point or if it is in a position where the scale rests against the back of the indicator and on the swivel hook as in [Figure 1-1](#).

Due to maintenance discharge imposed on the battery by the MSI-3460 electronics, do not store the unit with the battery inside. Remove the battery if it will not be used for more than two weeks. See [Section 3.3 on page 14](#) for battery removal instructions.

! **IMPORTANT:** Leaving a discharged battery in the scale, which has a maintenance battery drain, can result in a deep discharged battery which will shorten its service life.

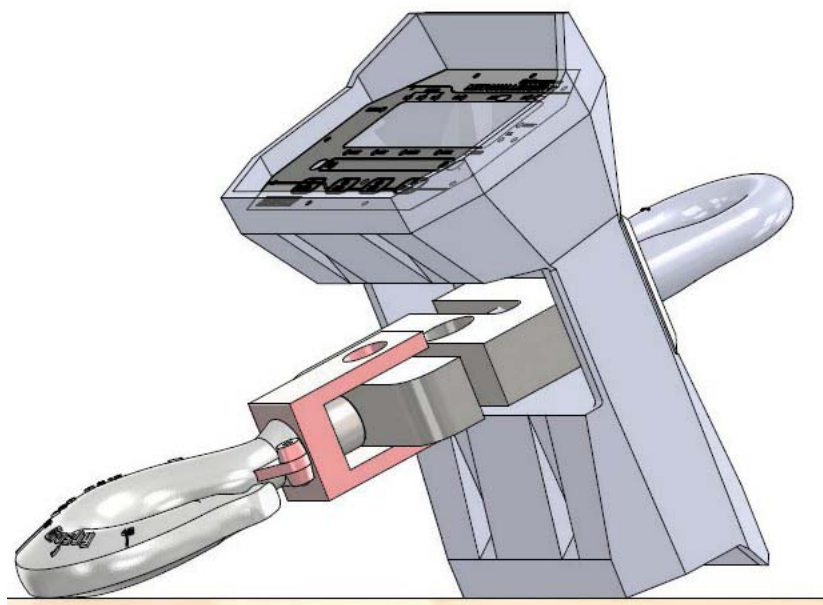

Figure 1-1. Stable MSI-3460 Storage

1.6 MSI-3460 Front Panel



Figure 1-2. MSI-3460 Front Panel

Keys

Item No.	Key/LED	Description
1		Turns the unit on and off; when the indicator is in setup mode, cancels action and returns to prior level without saving
2		Used to zero out residual weight on the scale; in setup mode, stores changes and returns to the prior level
3		Removes weight of containers, trucks or carriers and places scale in the NET weight mode functions as tare in, tare out; to view GROSS weight without resetting the tare value, program the USER key as NET/GROSS
4		Programmable to user-selectable functions (Section 4.0 on page 16); default is TEST

Table 1-1. Key Descriptions

Annunciators

Item No.	Key/LED	Description
5	STABLE	Indicates the weight has not settled within the stable window; when lit, scale will not zero, tare or total
6	SETPOINTS	User-programmable setpoints for early overload warnings; Blue LED - Setpoint 1 and 2; Red LED - Setpoint 3
7	→0←	Center-of-Zero – Indicates the weight is within 1/4 d of zero
8	ACK	Acknowledge LEDs are used to provide feedback to the operator; <ul style="list-style-type: none"> Blue LED - Incoming remote commands have been received; Red LED - Lights momentarily when enabled; lights to acknowledge Auto-Total operation
9	RF	Indicates carrier detect for RF remote display equipped unit; an illuminated LED indicates the MSI-3460 and remote display are linked; on units equipped with the RF remote control, the LED is illuminated for a half second when a remote command is received
10	LO BATT	Displays when approximately 10% of battery life remains, blinks when automatic shutdown is imminent
11	X1000	Used with TOTAL LED, allows accumulation of weight beyond the five digit display capacity
12	TOTAL	Indicates scale is displaying the Total weight; this is a temporary display lasting less than five seconds
13	GROSS	Indicates the scale is in the GROSS weight mode; all hook weight is displayed minus any zero offset
14	NET	Indicates the scale is in NET weight mode; tare weight is subtracted from the GROSS weight
15	PEAK	Indicates the scale is in peak hold mode
16	kg	Indicates weight display is in kilograms
17	lb	Indicates weight display is in pounds
18	----	5-Digit 1.5 in/3.8 mm high brightness LED weight display
19	----	Light sensor for auto brightness control
20	----	Calibration button under wire seal-able calibration port

Table 1-2. Annunciator Descriptions

2.0 Operation

The following sections describe the basic operation of the MSI-3460.



NOTE: If a function key does not work as expected, key is probably not set up to support the function.
For example, if the Function Key is set for TOTAL, the TOTAL mode must also be set up in the Setup Menu.

2.1 Power

To turn on the power, press . The following displays in this order:

- LED lights all segments at full brightness as a display test
- Display brightness changes to the setting determined in the display menu
- Software version number
- Weighing Standard
- The unit enters **Weigh** mode

2.2 Zero

Press  to take out small deviations in zero when the scale is unloaded. For zeroing (taring) package or pallet weights, see [Section 2.3 on page 12](#). The zero key can be used in **GROSS** or **NET** mode.



NOTE: The backup memory in the unit stores the zero reading and retains it even if the power fails.
Zeroing while in **NET** mode will zero the **GROSS** weight causing the display to show a negative tare value.

The scale must be stable within the stable window.

The unit will only zero if  is on and there has been no activity for two seconds.

The scale will accept a zero setting over the full range of the scale (NTEP and other Legal for Trade models may have a limited zero range).



Zero settings above 4% of full scale will subtract from the overall capacity of the unit.

Example: If 100 lb on a 1,000 lb scale is zeroed, the overall capacity of the scale will reduce to 900 lb, plus the allowed over-range amount.

2.3 Tare



Tare is used to zero out a known weight, such as a packing container or pallet, and display a **NET** weight. The **TARE** function is defined as a **Tare-In** or **Tare-Out** operation.

To tare the scale:

1. Hang the empty container from the scale.
2. Press  to enter a tare value. The MSI-3460 stores the current weight as a tare value and subtracts the value of the container from the **GROSS** weight.  displays and the weight mode changes to **NET**.
3. Add the product to the packing container. The **NET** weight is displayed.

2.3.1 View Tare

To view the **GROSS** weight without clearing the tare value:

1. Program  to the **NET/GROSS** function ([Section 4.2.4 on page 18](#)).
2. Press  to toggle between net and **GROSS** values. This will only work if a tare value has been established.



NOTE: The backup memory in the MSI-3460 stores the Tare reading and can restore it even if power fails. Only positive **GROSS** weight readings can be tared. The **STABLE** annunciator must be on, indicating weight reading is stable. Setting or changing the tare has no effect on the **GROSS** zero setting. Taring will reduce the apparent over range of the scale. The **RF Remote Control** has **NET/GROSS** permanently available.

*Example: Taring a 100 lb container on a 1,000 lb scale, the scale will overload at a **NET** weight of 900 lb (1,000-100) plus any additional allowed overload (usually 4% or 9 d).*

2.3.2 Clear Tare

To clear a saved tare value, press . The **GROSS** weight displays.

3.0 Installation

The MSI-3460 installs easily by hanging it on a crane using properly sized rigging (hooks, shackles, slings).



WARNING: Refer to the *Crane Scale Safety and Periodic Maintenance Manual (PN 153105)* for safe loading and rigging guidelines when installing the model MSI-3460.

Regular maintenance inspections of the lifting system should be performed to ensure safety. Pay particular attention to signs of stress on any element in the load train.

Use the appropriate interface hardware for the capacity and design of the scale.

- Rice Lake Weighing Systems can supply the MSI-3460 with oversize lifting eyes or shackle interfaces if the interface hardware does not fit properly.
- Install the scale using adaptive rigging if the crane hook is too large to fit in the lifting eye with single point interface.
- If multiple attachments are needed, use a shackle or ring to attach the multiple lines to keep a single point attachment to the scale.



IMPORTANT: Using an oversize shackle or hook to interface with the MSI-3460 can cause off-center loading and stress points that will reduce the life of the lifting eye or hook.

Single point attachments are necessary to ensure the safety and accuracy of the scale system.

3.1 Unpacking

Ensure that all assembly parts are accounted for when unpacking the scale from the shipping container. Check the scale for any visible damage and immediately report any damage to the shipper. Rice Lake Weighing Systems recommends using the original shipping container when shipping or transporting the MSI-3460.

3.2 Assembly

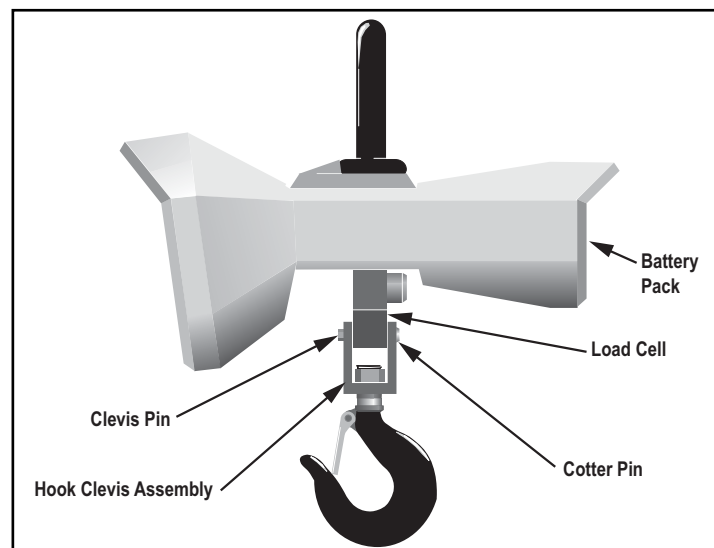

Figure 3-1. MSI-3460 Assembly

1. Slide the hook clevis over the load cell with the open end of the hook toward front of the scale.
2. Align the holes of clevis and load cell.
3. Slide the clevis pin through the clevis and load cell holes.
4. Lock the clevis pin in place with the cotter pin. Bend the cotter pin.



WARNING: The scale will be unsafe for use if the clevis pin is not properly secured with the cotter pin.

5. Slide the battery pack into the battery compartment. The battery will automatically engage with its connectors.
6. Secure the battery pack by turning the two locking fasteners on the access door clockwise 1/4 turn.

3.3 Battery Pack

The MSI-3460 is powered by a 6 V rechargeable battery. The battery door is part of the battery pack.

Scale operates for up to 50 hours using the battery life conserving modes included in the scale before requiring charging.

- Auto Off – Turns the scale off after a set amount of time of no scale activity ([Section 4.3 on page 19](#))
- Sleep Mode – Dims the display after a set amount of time of no scale activity ([Section 4.4 on page 19](#))
- Display Brightness – LED intensity can be lowered to save battery power ([Section 4.5 on page 20](#))
- Battery Life – When set to long, the system is placed into a sleep state for several seconds at a time if there is no change in weight ([Section 4.11 on page 23](#))

Charging time for a completely discharged battery is up to eight hours. A spare battery pack is recommended to keep the MSI-3460 in continuous operation.

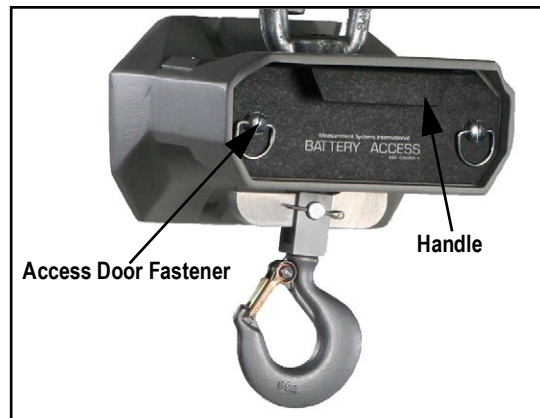

Figure 3-2. Battery Pack Removal

To Remove the Battery Pack

1. Turn the two fasteners on the access door counter-clockwise 1/4 turn.
2. Grasp the handle and pull the battery pack straight out. The battery will disengage from its connectors.



NOTE: Store the batteries between -4 – 122°F (-20 – 50°C) to obtain maximum service life. Stored batteries should be recharged every three months. Battery is fully charged when status indicator on the charger is flashing.

3.4 Battery Charger

The charger is a three-stage float charger that can be left on the battery indefinitely. It has a dual-color LED to indicate the charging state:

- RED – Fast charge mode
- GREEN – Charged or float charge

Charge the Battery

1. Remove the battery from the scale.
2. Plug the battery charger into an AC power receptacle. The input voltage is universal from 115/230 VAC, 50/60 Hz. If the power input plug doesn't match, contact Rice Lake Weighing Systems for information on international plugs.
3. Slide the battery charger connector plate over the top of the battery until the battery terminals mate with the charger connectors, as viewed through the two observation holes.
4. Six to eight hours is required to recharge a fully discharged battery. Partially discharged batteries finish the charge faster.

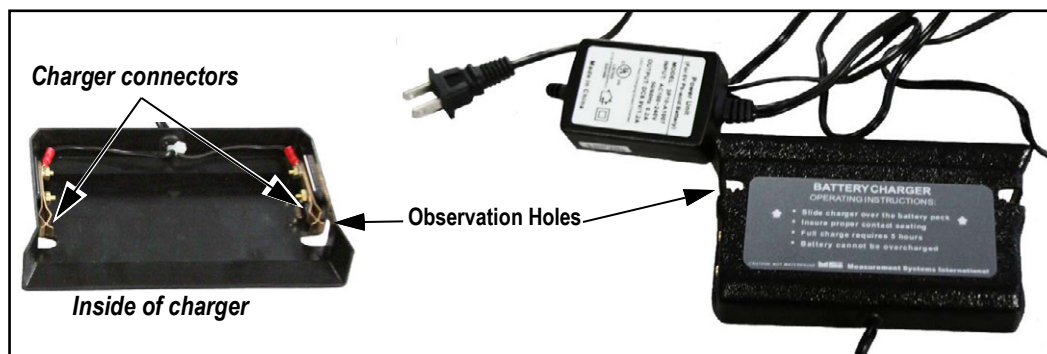

Figure 3-3. Battery Charger











NOTE: To obtain maximum service life from the batteries, the manufacturer suggests recharging after each 20 hours of use. Continuous deep discharging reduces the maximum battery life cycle estimated at 2,000 cycles.



A second battery is recommended to enable continuous scale use. Keep one on the charger while the other is in service.

4.0 Setup

The following keys can be used when navigating through the menus while setting up the MSI-3460.

-  exits setup without saving changes; $\square R n \square E L$ displays briefly and unit enters **Weigh** mode.
-  functions as the **Enter/Select** key.
-  functions as the **Scroll** key.
- To enter a decimal point, press  while the digit is blinking.
- Press  to save and go back one level; press it again to return to **Weigh** mode, $S \square O R E$ displays briefly.
- To change/correct a digit, press  to step back one digit and use  and  to change the digit.

4.1 Setup Menu

To enter into the MSI-3460 **Setup** menu, press  and  simultaneously.

Parameters	Choices	Description
FUNCL	oFF	Function User Key 1 – User definable key that can be programmed to one of several functions
		Function User Key 2 – User definable key that can be programmed to one of several functions; available if an RF remote is used
	tESt	Test Display – Section 4.2.1 on page 17
	tOtAL	Total – Section 4.2.2 on page 18
	v-IEt	View Total – Function always available on the RF Remote (Section 4.2.3 on page 18)
	nEtGr	NET/GROSS – Function always available on the RF Remote (Section 4.2.4 on page 18)
	P-Hld	Peak Hold – Section 4.2.5 on page 18 ; function not available or non-functional in OIML R76 or NTEP HB44 modes
	UnIt	Units – Section 4.2.6 on page 18 ; function not available or non-functional in OIML R76 & 1Unit modes
	Hi rES	High Resolution – x10 display resolution; for testing and maintenance use only; not a legal weigh mode; does not increase scale resolution or accuracy; non-functional in OIML R76 or NTEP HB44 modes (Section 4.2.7 on page 19)
Print	Print – Section 4.2.8 on page 19	
R-oFF	oFF 15 30 45 60	Auto Off Time – Prolongs the battery life of the scale by turning power off after the set time (in minutes) that the scale is not in use (Section 4.3 on page 19)
SLEEP	oFF 5 15 30	Sleep – Time (in minutes) before unit will enter sleep mode (Section 4.4 on page 19)
d. SPL	L0-1 L0-2 H1-1 H1-2 Auto	LED Display Intensity – Used to set the display brightness (Section 4.5 on page 20)
Color	rEd orG GrEEn rd-Gn	Red Orange Green Color changes based on passing setpoints 1 and 2; when selected, if setpoint 2 trips, the display color changes to orange; when setpoint 1 trips, the display color changes to red (Section 4.6 on page 20)
SEtPt 1-8	oFF GrEEt LESS	Setpoint 1 to 8 – Used for warnings or process control (Section 4.7 on page 21)
tOtAL	oFF tEtLon R .LoAd R .LRSt R .HiGH	Total Mode – Accumulation of multiple weighments (Section 4.8 on page 22)







Table 4-1. Setup Menu Parameters

Parameters	Choices	Description
Filter	OFF Lo Hi - 1	Weight Filter – Allows the scale to adjust to situations where there may be movement (Section 4.9 on page 23)
Unit	Lb Kg	Weight Units – Toggle units between pounds and kilograms; function not available or non-functional in OIML R76 & 1Unit modes (Section 4.10 on page 23)
Battery Life	Standard Long	Battery Life – Sets the options for standard or extended battery life (Section 4.11 on page 23)

Table 4-1. Setup Menu Parameters (Continued)

4.2 Set Function Key

The MSI-3460 has one user definable key  on the front panel that can be programmed to one of several functions. To set the function key use the following steps:

1. Press and hold  and . **FUNC** displays.
2. Press . The current user key function displays.
3. Press  to scroll through the available functions.
4. Press  when the desired function is displayed. **R-0FF** displays.
5. Press . **SETUP** displays briefly and exits **Setup** mode.



4.2.1 Test

The **TEST** function will automatically scroll through the following:





- Lights all LEDs at once
- Displays **SOFT** followed by the software version number
- Displays **BATT** followed by the battery voltage
- Displays **d. TEST** followed by the display counting from 00000–99999
- Displays **C-CAL** followed by the C-CAL value
- Weighing standard displays

Other internal tests are performed and if any test fails, an error code displays. See [Section 8.1 on page 41](#) for the troubleshooting guide.

To run a **TEST**:



1. Program the  to **TEST** ([Section 4.2](#)).
2. Press  to start the test. It runs through the complete test and returns to **Weigh** mode.

Single Step Through Test Procedure:

1. Press  within two seconds of test start to enable a single step mode.
2. Press  to scroll through the available test functions.
3. Press  to start or display the individual tests.
4. Press  to exit individual tests.
5. Press  to exit from the test function.

4.2.2 Total



Program the  to Σ (Section 4.2 on page 17).

The function that will be performed when pressing  will need to be set in Section 4.8 on page 22. If nothing has been set, nothing will happen when  is pressed.



NOTE: The Total mode must be programmed from the Setup Menus before the USER key will function.



4.2.3 View Total

1. Program the  to Σ (Section 4.2 on page 17).
2. Press  to activate the total weight display followed by the number of samples.
3. With the Total weight displayed, press  to clear.

4.2.4 NET / GROSS

Switches the display between **NET** and **GROSS** modes. NET weight is defined as **GROSS** weight minus a tare weight.

To switch between **NET** mode and **GROSS** mode:

1. Program the  to Σ (Section 4.2 on page 17).
2. Press  to toggle between **NET** and **GROSS** values. This will only work if a tare value has been established.

The operator can switch back to **GROSS** from **NET** without clearing the tare value. Only clearing or setting a new tare will change the tare value held before switching into **GROSS** mode.

OIML Legal for Trade units only: The **NET/GROSS** key is a temporary action only. The **GROSS** weight is displayed for two seconds and then the display returns to the **NET** mode. The only way to return to permanent **GROSS** readings is to clear the tare (Section 2.3.2 on page 12).

4.2.5 Peak Hold

Peak hold only updates the display when a higher weight reading is established.

The peak hold function uses a high-speed mode of the A/D converter allowing it to capture transient weights at a far higher rate than typical scales.

Peak hold is cleared and re-enabled with the , that has been set to $P-HL d$. See Section 4.2 on page 17.

Peak hold is not available on NTEP or OIML Legal for Trade certified scales.

4.2.6 Units

Units can be changed in two ways.



- To use the , program it to $U n i t$ (Section 4.2 on page 17).
- Change the units with the setup menu (Section 4.10 on page 23).



NOTE: Unit switching is not available on OIML certified Legal for Trade scales.

4.2.7 High Resolution Test Mode

High Resolution Test Mode displays weight at x10 resolution.

1. Program the  to H I - R E S (Section 4.2 on page 17).
2. Press  to toggle between normal and x10 resolution display.

All annunciators flash to indicate that the weight display is in x10 resolution test mode.

In some cases, the displayed weight in high resolution test mode will require six digits to fully display. In these cases, only the five least significant digits will be displayed. The full weight can be displayed in normal resolution by pressing the function button.

Ex: 1,000.02 kg will display as 000.02 kg.



NOTE: High resolution test mode is for scale service and diagnostic use only. Can result in significant instability in the displayed weight.

Increasing the scale display resolution beyond the calibrated value does not increase scale accuracy.

High resolution test mode is not available in NTEP HB44 standard.

When the standard is set to OIML R76, entering High Resolution Test Mode requires cycling power. When turning the scale on, the USER button must be pressed and held until the completion of the power on self-test. High Resolution Test Mode will be active after the completion of the self-test. To exit High Resolution Test Mode, power off the scale and restart normally without holding the USER button.







4.2.8 Print

If the print option is installed, this menu choice will appear. See Section 6.1 on page 32 for print setup information.

4.3 Auto-Off

The **Auto-Off** feature prolongs the battery life by automatically powering off the unit if no buttons are pressed and there is no change in the load exceeding 10 d for the time period, in minutes, set by the user. When a button is pressed or the detected load is in motion exceeding 10 d, the time limit is reset.

When disabled, the unit will only turn off by pressing , or if the battery dies. To set the **Auto-Off** function:



1. Press and hold  and . F U N C displays.
2. Press  to scroll to A - O F F.
3. Press . The current auto off time displays.
4. Press  to scroll through the available times.
5. Press  when the desired time is displayed. S L E E P displays.
6. Press  to exit setup and store the settings.





4.4 Sleep

The **Sleep** parameter reduces power consumption by automatically turning off the display during periods of inactivity, in minutes, set by the user. The green acknowledge annunciator blinks at one second intervals to indicate the unit is in the sleep mode. To wake the unit up, a button must be pushed (front panel or RF remote) or the weight must change by 5 d or more.



NOTE: Sleep must be set to less time than the Auto-Off timer.

1. Press and hold  and . F U N C displays.
2. Press  to scroll to the S L E E P function.





3. Press . The current sleep time is displayed.
4. Press  to scroll through the available times.
5. Press  when the desired time is displayed.
6. Press  to exit setup and store the settings.

4.5 Display Brightness

The **Display** setup menu is used to set the display brightness. There are four fixed brightness settings and one automatic light sensing brightness setting.



Auto setting automatically detects the ambient light and adjusts the brightness of the display accordingly.

There are four fixed brightness settings, **LO-1**, **LO-2**, **HI-1** and **HI-2**. Lower brightness settings increase battery life.

1. Press and hold  and . **FUN** displays.
2. Press  to scroll to the **dSP**.
3. Press . The current setting displays.
4. Press  to scroll through the available settings.



NOTE: The display brightness changes when each setting is displayed.

5. Press  when the desired setting is displayed. **SP** displays.
6. Press  to exit setup and store the settings.

4.6 Display Color

The MSI-3460 display supports four color schemes. Three of the color schemes display a steady color. The fourth, **rd-Gn**, changes the color of the display when setpoints 1 and 2 are tripped ([Section 4.7 on page 21](#)). This is useful in warning of possible overload conditions.

Color	Description
rd	Steady red
orG	Steady orange
grGGn	Steady green
rd-Gn	Variable Color — Display color changes based on setpoints 1 and 2; Green — No setpoints have been tripped Orange — Setpoint 2 tripped, setpoint 1 not tripped Red — Setpoint 1 tripped

Table 4-2. Display Colors

4.7 Setpoints

The MSI-3460 supports eight setpoints. There are three LED outputs that are triggered by the first three setpoints. Setpoints 4 through 8 do not trigger an indication on the MSI-3460, but can be set to control relays or trigger indications that are sent to other peripheral devices either through RS-232 or wireless communication. It comes standard with LED outputs for a triggered setpoint.

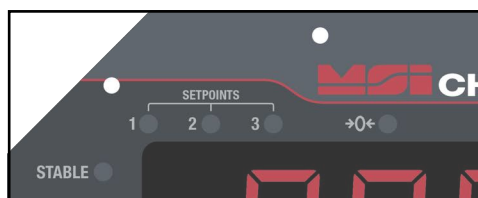













Figure 4-1. Setpoint LEDs

The MSI-3460 has an audible output option that is triggered by Setpoint 1. Contact Rice Lake Weighing Systems for other setpoint output options.

Setpoint	Description
Setpoint Mode	
OFF	Setpoint is not activated
GRERL	Indicates the setpoint will trigger when the weight exceeds a set value
LESS	Indicates the setpoint will trigger when the weight is less than a set value
Setpoint Weight Type	
NETGR	Responds to NET or GROSS weight
GROSS	Responds to GROSS weight regardless of the display
TOTAL	Responds to the totaled weight
T-CNT	Responds to the total count (number of samples)
LFENT	Responds to the number of times the weight has exceeded 25% of capacity

Table 4-3. Available Setpoint Settings

To set the setpoint:

1. Press and hold  and . **FUNC** displays.
2. Press  to scroll to the desired setpoint (**SET 1 - 8**).
3. Press . The current setpoint mode is displayed.
4. Press  to scroll to the setpoint mode desired.
5. Press . The current setpoint weight type is displayed.
6. Press  to scroll to the desired weight type.
7. Press . The current setpoint weight value is displayed.
8. Press  to scroll the numbers and  to enter each digit.
9. When the correct value is displayed, press . The next setup menu item is displayed.



NOTE: To enter a decimal point, press  while the digit is blinking. To correct a digit, press  to step back.

10. Press  to exit setup and store the settings.

4.8 Total Mode



For the accumulation of multiple weightments, the Total function uses the displayed load, so **GROSS** and **NET** readings can be added into the same total.

There are four modes of totalizing; manual and three auto modes.

All modes require that the weight on the scale return below 0.5% (relative to full scale) of **GROSS ZERO** or **NET ZERO** before the next weightment can be added. Applied weight must be $\geq 1\%$ of full scale above **GROSS ZERO** or **NET ZERO** before it can be totaled.

Manual Total

Manual Total (Total) adds a current weight to a previously accumulated value manually. To add weight to the total it must be greater than 1% of capacity and not yet totaled. This assures that a weight on the scale is only added to the total once.

1. Program the  to Total (Section 4.2 on page 17).
2. With the weight to be added on the scale, press . The acknowledge LED blinks to indicate the weight was accepted and the **TOTAL** annunciator lights. Then the total weight is displayed for five seconds and the number of samples is displayed for two seconds.
3. Repeat Step 1 and Step 2 until all weight samples have been added.



NOTE: Total Mode will not function while the scale is in motion, ensure scale is **STABLE**. If the system fails to achieve stable readings, increase the filter setting or increase the size of the scale division (d) in the Init Cal procedure.



functions as View Total only until the 1% threshold is exceeded to allow the addition to the total value.

Auto Total







This mode has three variations which are programmed in the Setup menu.

Program the  to **AUTO TOTAL**, it functions as **Auto Total On/Auto Total Off** (Section 4.2 on page 17).

Setpoint	Description
R .LORD	Auto Load – Ensures any settled load above the Rise Above threshold will be automatically totaled. The scale must fall below the Drop Below threshold before the next total is allowed.
R .LAST	Auto Last – Takes the last settled weight to auto total with. The total occurs only once the scale goes below the threshold. This allows the load to be adjusted without a total occurring. Once the load is removed, the scale uses the last settled reading for total.
R .HIGH	Auto High – Uses the highest settled reading. This is useful for loads that can't be removed all at once.

Table 4-4. Auto Load Selections







Set Total Mode

1. Press  and  simultaneously. FUNC 1 displays.
2. Press  to scroll to Total.
3. Press . The currently saved filter mode displays.
4. Press  to scroll through the choices.
5. With choice displayed, press  to select. FILTER displays.
6. Press  to exit setup and store the settings.







4.9 Filter Setup

Changing the filter settings allows the scale to adjust to situations where there is a lot of movement in the structure. If the reading is not stable, it can often be improved by increasing the filter setting. Settling time will be longer as the filter setting is increased. However, the MSI-3460 employs algorithms that speed up large weight changes while still controlling vibration even with high filter settings.

Use the following steps to set up filtering.

1. Press  and  simultaneously. *Func 1* displays.
2. Press  to scroll to *FILTEr*.
3. Press . The currently saved total mode displays.
4. Press  to scroll through the choices.
5. With choice displayed, press  to select. *Unit* displays.
6. Press  to save and exit to **Weigh** mode.

4.10 Unit







1. Press  and  simultaneously. *Func 1* displays.
2. Press  to scroll to *Unit*.
3. Press . *Unit* displays with lb or kg the display area.
4. Press  to toggle between lb and kg.
5. With the desired choice displayed, press  to select.
6. Press  to save and exit to **Weigh** mode.

4.11 Battery Life

Select either Standard (*Stand*) or Long (*Long*) battery life.

In Long battery life mode, the system is placed into a sleep state for several seconds at a time if there is no change in weight. This disables the display in order to reduce power consumption and increase battery life. After several seconds, the MSI-3460 will wake up to check for any changes in weight. If there is a change in weight, the unit will stay awake. The unit will also stay awake if it is in configuration mode.

Although long battery life mode can significantly increase battery life, performance of the scale is better in standard battery life mode.

1. Press  and  simultaneously. *Func* displays.
2. Press  to scroll to *battery*.
3. Press . The currently saved battery life displays.
4. Press  to toggle between the choices.
5. With choice displayed, press  to select. *Func* displays.
6. Press  to save and exit to **Weigh** mode.

5.0 Calibration

The MSI-3460 is calibrated using standard weights. It is required that the weight used is at least 10% of full capacity in order to achieve rated accuracy.

Example – Use at least a 500 kg test weight to calibrate a 5,000 kg capacity scale.

Although a single span point is usually adequate for rated accuracy, the MSI-3460 supports multi-point calibration with up to four span points plus zero.

When adequate test weights are not available, the unit can be calibrated using a calculated Constant Calibration (C-Cal). To use, a previously generated C-Cal number must be known. Rice Lake Weighing Systems supplies replacement load cells with the C-Cal value stamped on the serial number label.

There are three kinds of calibration:

- **Standard Calibration** – Used for maintenance and routine calibration
- **Initial Calibration** – Used to set up both the capacity and resolution (d) of the scale; it differs from Standard Calibration only in the initial steps; the initial calibration is performed after a calibration reset which completely erases the calibration and setup memory
- **C-Cal** – If the last calculated C-Cal value is known, the MSI-3460 can be calibrated without weights



NOTE: If the scale is being used as a Legal for Trade device, place a lead-wire seal through the cal screw over to the adjacent screw.

5.1 Calibration Switch Access

Use the following steps to access the calibration switch on the MSI-3460 if calibrating the unit using either the standard calibration or the C-Cal calibration.

1. Remove the hex seal screw from the MSI-3460.





















Figure 5-1. Calibration Button Seal Screw

2. Using a small non-conductive tool, press the calibration button located behind the hex seal screw. $\square RL$ displays.
3. Replace screw when calibration and setup is complete.

5.2 Standard Calibration

Use the following steps to calibrate the MSI-3460 using the standard calibration procedure.

1. Place the MSI-3460 into calibration mode ([Section 5.1 on page 24](#)).
2. Press . *UNLD* displays. Ensure there is no load on the scale.
3. Press . *0* displays briefly. If the scale is in range *PASS* is displayed, then *LOAD 1* displays.
4. Load the scale with a test weight (for a single span point calibration, a test weight of 20% of capacity or more is recommended).
5. Press . Current capacity flashes on the display. If loading the scale with capacity weight, continue to [Step 8](#).
6. Press  if using a calibration weight other than capacity. The far left digit of the display blinks indicating a number should be entered.
7. Press  to scroll through the numbers and  to enter each digit.
8. Press  to save the weight entry. If the cal value is within limits, *PASS* displays briefly, then *LOAD 2*.
9. Press  if more cal points are desired or  if a single point cal is needed.
10. Load the scale with the next test weight and press  if the weight value is acceptable.
11. Press  to scroll through digit choices and press  to enter the calibration weight value.
12. Press  again to complete the calibration span point. If the cal value is within limits, *PASS* displays briefly, then *LOAD 3* or *LOAD 4* displays.
13. Press  to enter additional span point or  if finished. *CAL d* displays to indicate success.
14. Press  and the display flashes *C-CAL* followed by the *C-CAL* number.
15. Press  to store the calibration. *SETUP* displays.
16. Press  to exit and return to **Weigh** mode.

















NOTE: If the scale is being used as a Legal for Trade device, place a lead-wire seal through the cal screw over to the adjacent screw.

5.3 Initial Calibration

Use this procedure only if the capacity and count-by (**d**) needs to be modified. The initial steps of the initial calibration will totally erase user setup as well as any previous calibration.

Use the following steps to calibrate using the initial calibration procedure.

1. Turn the MSI-3460 off.
2. Remove the hex seal screw covering the calibration button ([Section 5.1 on page 24](#)).
3. Press the **Cal** switch and  simultaneously. **RESET** displays.
4. Press  to reset the calibration constants. **STEP** displays.
5. Press  to reset. **CAL** displays.
6. Press . **Unit** displays.
7. Press . **Unit** will begin flashing.
8. Press  to select lb or kg; when the LED is lit by the correct unit, press . **CAP** displays.
9. Press . A capacity of 10,000 is the initial value and should not be set any higher than load cell rated capacity.
10. Press  to scroll through the numbers and press  to set the number.
11. With the correct number displayed, press . **d** displays.
12. Press . The current scale divisions display.
13. Press  to scroll through the available scale divisions.
14. When the desired value displays, press . **Unit d** displays, follow the standard calibration procedure in [Section 5.2 on page 25](#) (starting with [Step 2](#)) to complete calibration.



NOTE: If the scale is being used as a Legal for Trade device, place a lead-wire seal through the cal screw over to the adjacent screw.

5.4 Guidelines for Capacity and Resolution

Crane scales are subject to forces that regular floor scales do not experience. Bridge cranes, hoist cranes and mobile cranes lack rigidity and tend to bounce or swing when loads are lifted. Rice Lake Weighing Systems recommends that resolution be kept in the 1:2,000 to 1:3,000 range. Some improvement in stability can be achieved by increasing the filtering. If the MSI-3460 display is unstable, it is recommended that the resolution be reduced and/or filtering increased.

Due to Legal for Trade requirements and general scale design criteria, the weight must be stable for **ZERO**, **TARE** and **TOTAL** to work.

To improve stability:

- Increase the filtering, at the risk of increasing settling time
- Increase the d (reduce resolution)
- Increase the stable window



NOTE: The MSI-3460 defaults to $\pm 1 d$ as a stable window. It can be changed at Rice Lake Weighing Systems to a higher value if desired. Often $\pm 3 d$ is selected for bridge cranes as these tend to have a lot of bounce to them. This will carry an accuracy penalty, adding $\pm 3 d$ to the total accuracy of the scale, if the zero or tare operation happens to capture the weight in a valley or peak of the bounce.

Setting capacity is dictated primarily by the capability of the load cell. Many different capacities of the MSI-3460 are offered.



WARNING: Never set the capacity of the scale higher than the rating of the load cell.

Due to excellent linearity of the MSI S-Beam load cell, it is acceptable to set lower capacities to better match the crane that the MSI-3460 is used on.

Example: If the hoist is rated for 9,000 lb, then use a 10,000 lb weight and reset the capacity to 9,000 lb.

Use the Initial Calibration procedure for this calibration. De-rating as much as 50% of the capacity is usually acceptable, but the scale may be less stable if the d is decreased.

Due to kg to lb conversions, the capacity of all MSI-3460 systems is rated approximately 20% higher than the rated capacity in pounds. This is to allow the kg capacity to be exactly 1/2 the number of the pound capacity.

5.5 Constant Calibration (C-Cal)





When adequate test weights are not available, the MSI-3460 can be calibrated using a programmed constant calibration which is referred to as C-Cal. To use this, the C-Cal number must be known from a previous calibration. Rice Lake Weighing Systems supplies replacement load cells for the MSI-3460 with the C-Cal value stamped on the serial number label. When a calibration is performed with test weights, a new C-Cal is generated. C-Cal can be used when the electronics are replaced to get an approximate calibration that is suitable for non-Legal for Trade applications.









IMPORTANT: The C-Cal number must be known prior to starting this procedure. For an MSI-3460 with its original load cell, Rice Lake prints this number on the calibration record, the serial number tag and on the calibration log found inside the battery compartment.

C-Cal can slightly reduce the absolute accuracy of the system if the electronics are replaced or a new load cell is installed and is intended for non-critical use only. Legal for Trade installations require that the MSI-3460 is calibrated using test weights. If a system was originally multi-point calibrated, the C-CAL calibration will erase the additional span points, as C-Cal is only a two point calibration (zero and span at 10% of capacity).

Use the following steps to perform a C-Cal calibration.

1. Enter **Configuration** mode (Section 5.1 on page 24). $\llcorner RL$ displays.
2. Press  to scroll to $\llcorner RL$.
3. Press . $\llcorner L d$ displays. Ensure all weight has been removed from the scale.
4. Press  to set the zero calibration point. A flashing \square displays. If the zero is in range, the scale will display **PASS**, then displays $\llcorner RL$.
5. Press . A flashing \square displays.







6. Press  to enter the C-Cal value. The far left digit will flash indicating that number should be entered.
7. Press  to scroll through the numbers and  to enter each digit.
8. When the correct number is displayed, press  to save. The display will read *PASS* followed by *CAL d*.
9. Press  to exit **C-Cal Setup** menu.
10. Press  to store the calibration and return to the weigh mode. *STORE* displays briefly.

5.6 Standard Menu

Selection	Description
Industrial (<i>INDUS</i>)	This is the most common setting for the MSI-3460; with the Industrial standard, there is full range zero, access to unit switching, filters, and peak hold
Handbook 44 (<i>HB-44</i>)	Enables only approved features per the NTEP HB-44 rules and regulations; access is denied to Peak Hold, and the zero range may be limited; the Filter menu is moved to the calibration setup menu, so filters are only accessible through the calibration seal
R-76 (<i>R-76</i>)	Sets the scale to enable only approved features per OIML R-76; only kg weight units are available; the zero range is limited to 4% (-1 to +3% relative to calibrate zero); NET/GROSS function is temporary; once NET weight is established, pushing an F key set for NET/GROSS will cause a maximum 5 second display of the GROSS weight; clear the Tare to display GROSS weight constantly; other metrological aspects are changed to meet R-76 requirements; only stable weights may be printed; negative weight display is limited to -20d
1Unit (<i>1UNIT</i>)	The 1Unit standard is exactly the same as Industrial, except unit switching is inhibited; this is useful for metric only countries; another use of the 1Unit standard is to allow the scale to be calibrated in units other than lb or kg, since conversions are eliminated; Contact Rice Lake for more information on the standard settings

Table 5-1. Standard Menu Selections

Use the following steps to set up standard settings.

1. Enter **Configuration** mode (Section 5.1 on page 24). *CAL* displays.
2. Press  to scroll to *SETUP*.
3. Press . *Stand* displays.
4. Press . The current standard setting is displayed.
5. Press  to scroll to the desired standard.
6. Press  to set the standard.
7. Press . *AutoCAL* is displayed.
8. Press  twice to exit setup and store all changes. *STORE* is displayed briefly, then the unit goes to **Weigh** mode.







5.7 Auto Zero Maintenance (AZM)

An auto zeroing maintenance mechanism is used to adjust the zero reading to the center-of-zero. The center-of-zero is defined as the weight reading within 1/4 d of zero. AZM continuously adjusts zero to maintain the center-of-zero. It is recommended that AZM is on to maintain the highest accuracy.

There are circumstances when it should be turned off. This can happen when minor variations of weight occur while picking up scale attachments and the variations fall within the AZM capture window. The AZM capture window (usually 1 d) and capture time (usually 8 seconds) can be adjusted by Rice Lake Weighing Systems to meet custom requirements.







The settings of AZM are dictated in Legal for Trade standards and cannot be adjusted.

Use the following steps to set up Legal for Trade standard settings.

1. Enter **Configuration** mode ([Section 5.1 on page 24](#)). *CRAL* displays.
2. Press  to scroll to *SEtUP*.
3. Press . *StAnd* displays.
4. Press  to scroll to *Aut00*.
5. Press . The current setting is displayed.
6. Press  to toggle between *On* or *OFF*.
7. Press . *0. P-UP* displays.
8. Press  twice to save settings. *StorE* displays briefly and exits setup.







5.8 Zero Power Up (0.P-UP)

This feature will cause the unit to automatically zero after the unit is turned on. Default is *OFF*.

1. Enter **Configuration** mode ([Section 5.1 on page 24](#)). *CRAL* displays.
2. Press  to scroll to *SEtUP*.
3. Press . *StAnd* displays.
4. Press  to scroll to *0. P-UP*.
5. Press . The current setting is displayed.
6. Press  to toggle between *On* or *OFF*.
7. When desired value is displayed, press . *FILtR* displays.
8. Press  twice to save settings. *StorE* displays briefly and exits setup.

5.9 Filter

Changing the filter settings allows the scale to adjust to situations where there is a lot a movement in the structure. If the reading is not stable, it can often be improved by increasing the filter setting. Settling time will be longer as the filter setting is increased. However, the MSI-3460 employs algorithms that speed up large weight changes while still controlling vibration even with high filter settings. Selections are OFF, L0 and H 1.

1. Enter **Configuration** mode (Section 5.1 on page 24). **CAL** displays.
2. Press  to scroll to **SEtUP**.
3. Press . **SEtPnd** displays.
4. Press  to scroll to **F ILtR**.
5. Press . The current setting displays.
6. Press  to scroll to desired setting.
7. When desired value is displayed, press . **SEtPnd** displays.
8. Press  twice to save settings. **SEtOrE** displays briefly and exits setup.

5.10 Gravity Compensation

Gravity Compensation allows for calibrating in one geographic location for use in a different geographic location. Gravity can be set to OFF, ON or Factor.

Parameter	Choices	Description
OFF		Gravity compensation disabled
On	--	Calculates Gravity compensation using the origin and destination latitudes and elevations
	LRtOr 0-90	Latitude of Origin - Original latitude (to nearest degree) for gravity compensation; 47 (default)
	ELtOr -9999-9999	Elevation of Origin - Original elevation (in meters) for gravity compensation; 10 (default)
	LRtdt 0-90	Latitude of Destination - Destination latitude (to nearest degree) for gravity compensation; 47 (default)
	ELtdt -9999-9999	Elevation of Destination - Destination elevation (in meters) for gravity compensation; 10 (default)
FRctOr	--	Calculates gravity compensation using origin and destination gravity factors
	FRcOr 9.00000-9.99999	Gravity of Origin - Original gravity factor (in m/s ²) for gravity compensation; 9.8080 (default)
	FRcdt 9.00000-9.99999	Gravity of Destination - Destination gravity factor (in m/s ²) for gravity compensation; 9.8080 (default)

Table 5-2. Gravity Compensation Parameters



NOTE: To find the local gravity, enter the latitude and elevation into the International Gravity Formula. Listed are links to websites that can be used to determine local latitude and elevation. Please note these website addresses are provided for reference only and may change.















Map Coordinates uses Google maps to find latitude and elevation: www.mapcoordinates.net/

Once local latitude and altitude have been determined, use the following link to calculate local gravity <http://www.sensorzone.com/local-gravity-calculator/>













IMPORTANT: The gravity correction function has not been evaluated by an approvals agency, therefore it is up to the authorized scale dealer to ensure the device is accurate at the intended point of use.

5.10.1 Compensation by Latitudes and Elevations

1. Enter **Configuration** mode ([Section 5.1 on page 24](#)). \overline{CAL} displays.
2. Press  to scroll to \overline{SEtUP} .
3. Press . \overline{StAnd} displays.
4. Press  to scroll to \overline{GRAD} .
5. Press . The current setting displays.
6. Press  to scroll to \overline{Or} .
7. Press . \overline{LATOr} displays.
8. Press  to enter latitude of origin.
9. Press . \overline{ELEOr} displays.
10. Press  to enter elevation of origin.
11. Press . \overline{LATdE} displays.
12. Press  to enter latitude of destination.
13. Press . \overline{ELEdE} displays.
14. Press  to enter elevation of destination.
15. Press  to accept elevation of destination.
16. Press  twice to save settings. \overline{StOrE} displays briefly and exits setup.

5.10.2 Compensation by Gravity Factor

1. Enter **Configuration** mode ([Section 5.1 on page 24](#)). \overline{CAL} displays.
2. Press  to scroll to \overline{SEtUP} .
3. Press . \overline{StAnd} displays.
4. Press  to scroll to \overline{GRAD} .
5. Press . The current setting displays.
6. Press  to scroll to \overline{FRctOr} .
7. Press . \overline{FRctOr} displays.
8. Press  to enter original gravity factor.
9. Press . \overline{FRctdE} displays.
10. Press  to enter destination gravity factor.
11. When desired value is displayed, press .
12. Press  twice to save settings. \overline{StOrE} displays briefly and exits setup.

6.0 Communications

The MSI-3460 can communicate with peripheral devices using 802.15.4, or 802.11/b, g, n Wi-Fi.

The 802.15.4 transceiver is used to communicate between the MSI-3460 and a MSI-8000 RF or MSI-8004HD Remote Display. The 802.15.4 transceiver is also capable of connecting to any supported device with an 802.15.4 Modem. 802.15.4 operates in the 2.4 GHz ISM band and does not require the end user to obtain a license. 802.15.4 can coexist with other 2.4 GHz systems if caution is taken to isolate antennas at least 10 ft (3 m) from the crane scales and if an MSI-8000 Remote Display acts as the network coordinator.

The 802.11 Wi-Fi option communicates directly with a standard RF access point. This option is covered by the Wi-Fi for ScaleCore User Guide.

6.1 Printer / Serial Output Setup

All RF-linked device weight modes are available in user formatted form.

Communications port settings are independent of print settings in connected displays/indicators. Communication port settings only reside in the MSI-3460.

Parameters	Choices	Description
Listen	--	Listen – Connects with an RF remote
Output-P	Port .0 rF	Output Port – Select output port for print
Serial	--	Serial String – For use in printing (Section 6.1.1)
Control	USER LOAD CONTINUOUS OFF	Control – Print mode selected (Section 6.1.2 on page 33)
Rate	0-65535	Rate – Output rate in seconds, 0 is the fastest possible setting

Table 6-1. Print Parameters



NOTE: RS-232 output directly from the MSI-3460 crane scale is not an available option. It is recommended that printing be done wirelessly using a MSI-8000HD or MSI-8004HD remote display.

6.1.1 Standard Print Strings

Commands that can be used to format gross, net and print formats are shown below.

Command	Description
<T>	Load data
<U>	Units
<M>	Load mode (lb/kg)
<CRLF>	Carriage return line feed
<SP>	Space

Table 6-2. Standard Print Strings Commands

Print String	Choices	Description
1	Current load	Fixed output length: 16. Leading zeros suppressed except for the least significant digit (LSD); <TTTTTT><SP><UU><SP><MMMMM><CRLF>
2	NET load	Fixed output length:16. Leading zeros suppressed except for the LSD; <TTTTTT><SP><UU><SP>NET<SP><SP><CRLF>
3	GROSS load	Fixed output length: 16. Leading zeros suppressed except for the LSD. <TTTTTT><SP><UU><SP>GROSS<CRLF>
4	Tare Weight	Fixed output length:16. Leading zeros suppressed except for the LSD; <TTTTTT><SP><UU><SP>TARE<CRLF>
5	Total Weight	Fixed output length: 16. Leading zeros suppressed except for the LSD; <TTTTTT><SP><UU><SP>TTL<CRLF>
6	Number of Samples Totaled	Fixed output length: 16. Leading zeros suppressed except for the LSD; <SP><SP><SP><SP><SP><SSSSSS><SP><T-CNT>SP<CRLF>
7	Current Weight Mode	NET, GROSS, Peak, etc; <SP><MMMMM><CRLF>
8/9	Carriage Return/ Line Feed	Used to add a space between print records; <CRLF>

Table 6-3. Standard Print Strings

Combinations of the standard print strings can be entered in the string number entry screen.

Example: To get a NET, GROSS, TARE printout with a space between records, enter 2349.

The ScaleCore Connect software can also be used for custom output strings. It can be downloaded from www.ricelake.com.

The serial output is configured as 9600 baud, Xon/Xoff handshaking, no hardware handshaking, 1 stop bit, no parity. Other baud rates are possible by special order only.

6.1.2 Control Modes

The user can select three control modes which are described in [Table 6-4](#).























Mode	Description
User	Printing is controlled by the operator using  if set to Print mode; If using a remote device, there may be a dedicated PRINT key (F-key 3) available
Load	One print occurs when a stable load is read. The scale must then return to near zero before another print will occur; Note: Other configurations of loads are available using the ScaleCore Connect software. It can be downloaded from www.ricelake.com
Continuous	The MSI-3460 will continuously output the data at a rate specified in the rate parameter (up to 65,535 seconds); setting the interval to 0 will set an interval as fast as the system can go
Off	Printing is disabled. Power consumption is lower with the print off

Table 6-4. Control Modes

6.1.3 Printer Output Setup

Use the following steps to set up the printer output.

1. Press  and  at the same time. *Pr int* is displayed.
2. Press . *L iStEn* is displayed.
3. Press . The current setting flashes.
4. Enter the number using  to scroll through numbers and  to set number.
5. Press . *DUt-P* displays.
6. Press . The current setting flashes.
7. Use  to toggle between *Port0* and *rF*.
8. When the desired setting is displayed, press . *StEnG* displays.
9. Press  to enter.
10. Enter the number using  to scroll through numbers and  to set the string number desired.
11. When set, press  again. *cntrl* displays.
12. Press  to enter. Current setting flashes.
13. Press  to scroll through the settings.
14. When desired setting is displayed, press . *rAtE* displays.
15. Press  to enter.
16. Enter the number using  to scroll through numbers and  to set number.
17. Press  again. *L iStEn* displays.
18. Press  twice to save settings. *StorE* displays briefly and exits setup.



NOTE: When entering numbers, pressing  will step back a digit for corrections.

6.2 RF Network Setup

The MSI-3460 uses 802.15.4 transceivers to communicate with an MSI-8000 or MSI-8004HD Remote Display or another supported device with an 802.15.4 Modem.

The MSI-3460 uses three numbers to establish a piconet. A piconet is a network that is created using a wireless connection. [Table 6-5](#) lists out the elements used in setting up a piconet.

 **NOTE:** Ensure a relatively clear transmission path exists between the devices to be connected. Radio signals travel primarily by line of sight (LOS), obstructions between stations may degrade the system performance.

6.2.1 802.15.4 RF Network Setup

When equipped with the 802.15.4 option, the MSI-3460 can connect with an MSI-8000 or MSI-8004HD Remote Display or another supported device with an 802.15.4 Modem.













Choices	Parameters/Range	Description
On .oFF	On oFF	Enable RF – Affects continuous mode only
SC id	0-254	ScaleCore ID – Used to identify each ScaleCore device in a piconet, must not be duplicated within the same RF Channel 0-30 (recommended)
CHNL	12-23	RF Channel – Establishes the base network that all interconnected devices must match, range 12-23
Net id	0-99999	Network ID – A 64 bit number that all interconnected devices must match; the MSI-3460 limits this number to a max of 5 digits in a range of 0-99999 Note: Do not use a small number here to help avoid other 802.15.4 networks that default to a Network ID of 0 Range 0-99999
TYPE	2bEE oEtHEr	Connection Type – Type of card being used
Hold	On oFF	RF Hold – If Hold is set to on, power to the radio stays on, even when the scale is turned off; this is required if the Rugged Remote or a remote display will be used to turn the MSI-3460 on; this causes some battery to drain when the scale is off; hold should be set to off unless it is required in order to maximize battery life









Table 6-5. RF Menu Parameters

To enter the menu:

1. Press the  and  keys at the same time. *Pr net* displays.

 **NOTE:** *busy* may flash momentarily before entering the communications menu.

2. Press . *rF* displays.
3. Press . *On. OFF* displays.
4. Press  to scroll through parameters.
5. Press  to enter parameter. The current value flashes.
6. With parameter displayed, press  to select. The currently selected parameter flashes.
7. Press  to scroll through settings.
8. Press . *SC id* is displayed.
9. Press . The current ID flashes. If SCID is correct, continue to [Step 11](#).
10. Enter the ID using  to scroll through numbers and  to set number.
11. When ID is set, press  again. *CHNL* displays.
12. Press . The current channel flashes. If the channel number is correct continue to [Step 14](#).

13. Enter the channel using  to scroll through numbers and  to set number.
14. When channel is set, press  again. *net id* displays.
15. Press . The current net ID flashes. If the net ID is correct, continue to [Step 17](#).
16. Enter the network ID using  to scroll through numbers and  to set number.
17. When the Net ID is set, press  again. *On. OFF* displays.
18. Press  twice to save and exit to **Weigh** mode.



NOTE: When entering numbers, pressing  will step back a digit for corrections.











6.2.2 Hold Feature

The hold feature is used to keep the modem on even when the display is off. It is used if desired with a Rugged Remote.



NOTE: The Hold feature causes the device's modem to stay on and continuously draw from the battery, even when the device is turned off, resulting in decreased battery life.

To Enable it follow these steps:

1. Press  and  simultaneously. *Pr net* displays.
2. Press . *rF* displays.
3. Press . *On. OFF* displays.
4. Press  to enter *On. OFF*.
5. Press  to select *On*.
6. Press  to scroll to *Hold*.
7. Press  to enter the *Hold*.
8. Press  to select *On*.
9. Press  twice to store settings and return to Weigh mode.

6.3 Radio Compliance

All radio options meet FCC and international radio compliance per the certification information listed in this section.

These modules may have additional international certifications that are not listed in this section.

Please contact Rice Lake Weighing Systems if you require operation in a jurisdiction that is not listed.

6.3.1 802.15.4 (XBee 3 and XBee 3-PRO)

FCC Statement

Contains FCC ID: MCQ-XBEE3

International Certifications

Canada: Radio Certificate Number: IC 1846A-XBEE3

Australia: RCM

Brazil: ANATEL 06329-18-01209

EU (XBee 3 only): Yes, when used with CE approved products

Japan (XBee 3 only): R210-119309

Mexico: IFETEL (IFT) RCPDIXB19-1820

South Korea (XBee 3 only): R-C DIG-XBEE3

6.3.2 802.15.4 (XBee 2SC)

FCC Statement

Contains FCC ID: MCQ-S2CTH

International Certifications

Canada: Radio Certificate Number: IC 1846A-S2CTH

Australia: RCM

Brazil: ANATEL 0616-15-1209

EU: Yes, when used with CE approved products

Japan: R210-105563

Mexico: IFETEL (IFT) RCPDIS219-1821-A1

South Korea: MSIP-CRM-DIG-XBee-S2C-TH

6.3.3 Wi-Fi

FCC Statement

Contains FCC ID: T9J-RN171

International Certifications

Canada: Radio Certificate Number: IC 6514A-RN171

Korea: Radio Certificate Number: KCC-CRI-029-RN-171

Europe: The product is compliant with the following standards and/or other normative documents:

- EN 300 328 : V1.8.1 (2012)
This product is compliant with the following standards and/or other normative documents:
Safety (article 3.1A) EN 60950-1:2006+A11:2009+A1:2010+A12:2011
EMC (article 3.1b) EN 301 489-1 : V1.9.2 (2011) In accordance with the specific requirements of ETSI EN 301 489-17: V2.2.1 (2012)

6.3.4 Bluetooth®

FCC Statement

Contains FCC ID: T9J-R41-1

International Certifications

Canada: Radio Certificate Number: IC 6514A-RN411

Europe: This product is compliant with the following standards and/or other normative documents:

- EN 300 328-1
- EN 300 328-2 2.4GHz

6.3.5 FHSS (Frequency Hopper Spread Spectrum)

FCC Statement

Contains FCC ID: HSW-DNT24

International Certifications

Canada: Radio Certificate Number: IC 4492A-DNT24

ETSI Certified

7.0 Optional Rugged Remote

The MSI-3460 with an installed RF modem can be controlled with an optional Rugged Remote (PN 173014). The Rugged Remote is a transmit only device that can be used to perform basic scale functions. The range may vary up to 100 ft or more depending on room conditions and line of sight.

The RF modem in the MSI-3460 must be configured to accept communication from the Rugged Remote, contact Rice Lake Weighing Systems for pairing requirements.



NOTE: A Rugged Remote is paired to an individual device and cannot be reprogrammed in the field.



Figure 7-1. Rugged Remote

7.1 Operation

The Rugged Remote is paired to a single ScaleCore RF device and replicates the front panel buttons. Slight variations between each device's buttons will result in different operation in the Rugged Remote. See [Table 7-1](#) for corresponding buttons for the Rugged Remote and the connected device.



NOTE: The Rugged Remote can only be paired to a single ScaleCore device. Reprogramming to configure communication to a different ScaleCore device can only be performed at the factory or with the purchase of additional RF modems.

Rugged Remote	MSI-3460	Description
		Power
		Zero
		Tare
		Function

Table 7-1. Corresponding Buttons

7.1.1 Power

The Rugged Remote can be enabled to turn the Scale Core device on and off if it is paired remotely. The hold function must be enabled in the MSI-3460 ([Section 6.2.2 on page 36](#)).

Press  to power the MSI-3460 on and off.



NOTE: *The Hold feature causes the device's modem to stay on and continuously draw from the battery, even when the device is turned off, resulting in decreased battery life.*

7.1.2 Zero



Press  to remove small deviations in zero when the MSI-3460 is unloaded ([Section 2.2 on page 11](#)).

This key is not programmable.

7.1.3 Tare

Press  to tare the MSI-3460 ([Section 2.3 on page 12](#)).

7.1.4 Programmable Function Keys

 and  are programmable in the MSI-3460. See [Section 4.2 on page 17](#) to configure the MSI-3460 function keys for Rugged Remote operation.

7.2 Conflict and Jamming Considerations

It is important to understand that only one transmitter at a time can be activated within a reception area. While the transmitted signal consists of encoded digital data, only one carrier of any frequency can occupy airspace without conflict at any given time. This is not to say that there cannot be multiple remote controls for the unit, but rather that two cannot be used simultaneously.

7.3 FCC Compliance

The Rugged Remote has 802.15.4 certification ([Section 6.3 on page 37](#)).

8.0 Maintenance

8.1 Troubleshooting

Problem	Possible Cause	Solution
Display is blank when Power key is pressed	Discharged battery	Recharge, allow at least four hours charge
	Defective battery	Replace
	Corroded battery or battery contacts	Clean contacts
	Defective switch or circuit board	Requires authorized service
Display does not function properly, front panel keys do not function normally, or scale will not turn off	Improperly updated software	Reinstall software
	Faulty circuit board	Requires authorized service
	Loose connectors	Requires authorized service
Scale does not respond to weight changes	Out of calibration	Calibrate
	Faulty load cell	Replace
	Load cell connector	Check connector and wires
Display over ranges below 100% capacity	Tared weight is added to load to determine overload point	Return to GROSS Weight mode
	Zero requires adjustment	Rezero the scale
	Too much weight has been zeroed	Rezero the scale
Display Drifts	AZM (Auto0) is turned off	Turn AZM on
	Rapid temperature changes such as moving the scale from indoors to outdoors	Wait until the scale temperature has stabilized
Displayed weight shows large error	Scale not zeroed before load is lifted	Zero the scale with no load attached
	lb/kg units causing confusion	Select proper units
	Requires recalibration	Recalibrate
Display reading not stable	Excessive vibration in crane system	Increase filtering or increase d in cal
	Excessive side loading	Improve load train symmetry
	Load cell faulty	Check Load Cell (LC) connections
Display toggles between Error and Load	Weight exceeds capacity	Reduce weight immediately
	Faulty load cell or wiring	Check LC and LC wiring
Display toggles between Error and A2DLo	A/D is saturated negative	Check LC and LC wiring
Display toggles between Error and buttn	A key is stuck or is being held down	Check switches for damage
		Ensure that a remote is not transmitting continuously
Optional RF remote does not work	Units not mated	See Section 6.2 on page 35 for additional network setup information
Lo Batt is blinking	Battery is low	Recharge battery
Unit turns on, then immediately off	Battery is low	Recharge battery
Weight will not zero	System not stable	Wait for STABLE annunciator to turn on Increase filtering for more stability
	Zero out of range	Legal for Trade (LFT) units have limited zero range; reduce the weight or use tare instead
Weight will not tare or total	System is not stable	Wait for STABLE annunciator to turn on, or if in a mechanically noisy crane, increase the filtering or reduce the size of the scale increment d ; the motion window can also be increased. Contact RLWS if there is a problem getting the MSI-3460 to zero, tare or total due to stability issues
Setpoint lights blink	Setpoint is enabled and the trigger point has been reached	Disable setpoints if they are not needed
Manual total does not work	A function key is not set to Total	Set up Func for Total
	Weight must be stable	Increase filtering for more stability
Auto total does not work	Weight must be stable	Wait for the STABLE annunciator to turn on, or increase filtering for more stability
	Weight thresholds not reached	Weight thresholds must exceed 1% of capacity for autototal to work; then it must drop below 0.5% of capacity for additional weighments to register

Table 8-1. Troubleshooting

8.2 Service Counters



WARNING: Only a Rice Lake Weighing Systems factory representative can reset the service counters, as these are an important safety warning feature. A thorough load train inspection is necessary to ensure product safety.

Service Counters are important safety warning features and can only be reset at the factory by certified Rice Lake personnel.



As part of the reset process, the service technician will perform a thorough load train inspection to ensure user safety and confirm that the product is ready to be returned for regular service.

See the Crane Scale Safety and Periodic Maintenance Manual (PN 153105) for proper loading techniques to improve the safety and longevity of your MSI Overhead Weighing Product. Download the Crane Scale Safety and Periodic Maintenance Manual (PN 153105) at www.ricelake.com.

The MSI-3460 maintains two service counters for safety.

- The first counter counts the number of times the scale has been overloaded.
- The second counter counts lifts above 25% of capacity.





These counters serve to warn the user to inspect the load train after a number of overloads, also when there is a chance of fatigue failure. The power up routine will be interrupted when the lift counter exceeds 16,383 lifts or the overload counter exceeds 1,023 overloads. If the screen displays *LFCnE* when unit is powered on:

1. Press  to display the 25% lift counter.
2. Press  again to see the overload lift counter.
3. Press  to acknowledge the warning and return to standard scale operation.





NOTE: The power up warning message will not appear again for another 16,383 lifts (or 1,023 overloads).

To Access the Service Counters

1. Program  to be TEST (Section 4.2 on page 17).
2. Press .
3. Within two seconds of pressing , press . The display flashes *LFCnE* (for Lift Counter) followed by the number of times the weight has exceeded 25% of capacity.



NOTE: Press  to step through the service counters.

4. Press . The display flashes *OLCnE* (for Overload Counter) followed by the number of times the weight has exceeded capacity.
5. Press . The display flashes *C-CAL* followed by the C-Cal value.
6. Press . Returns to standard **Weigh** mode.

8.3 Software Update

For use with ScaleCore3 Printed Circuit Assembly (Circuit Board)

Equipment Requirements

- PC with terminal program
- Interface Cable PN: 503230-0001 (10 ft) or -0002 (5 ft)

Updating Process

1. Connect interface cable to P2.

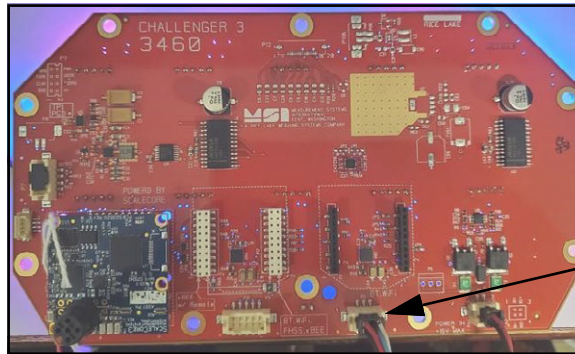

Figure 8-1. Connecting Interface Cable

2. Power on the scale.
3. Open the terminal program.

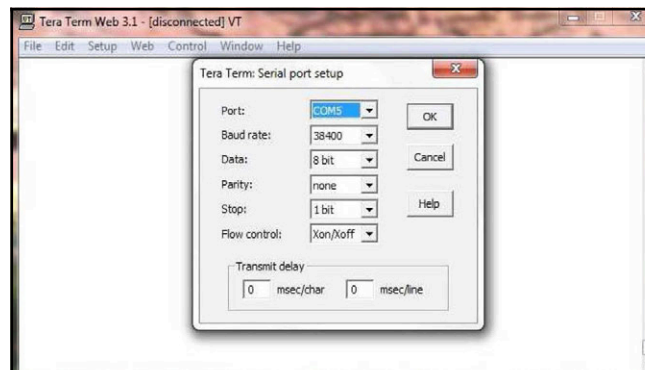

Figure 8-2. Serial Port Setup

4. Configure to the following:
 - Baud Rate: 38,400
 - Data Bits: 8
 - Parity: None
 - Stop Bits: 1
 - Flow Control: XON/XOFF

- Type: {00FF09=0199}, then press **Enter**. This command accesses the boot-loader program within the ScaleCore. `bL0Ad` displays on the MSI-3460 and the ScaleCore Boot Loader menu appears on the terminal screen.

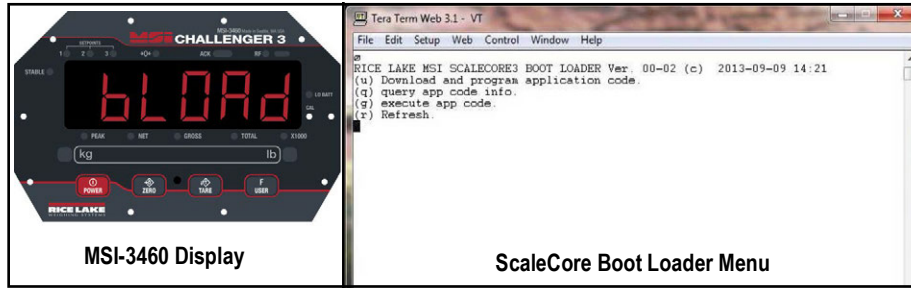

Figure 8-3. Access Bootloader From ScaleCore

- Type `u` to download and program the application code. The boot loader program prompts to send the file.
- Select the file, then send. Wait for a complete file transfer.

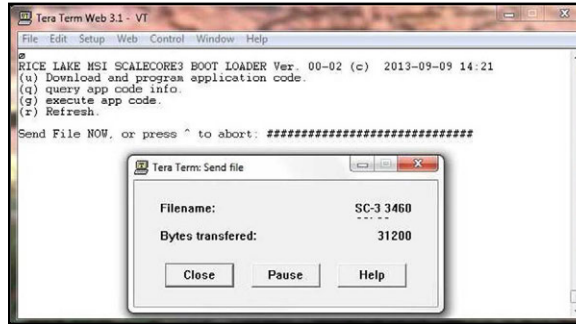

Figure 8-4. Send File

When complete, the boot loader menu appears on terminal screen.

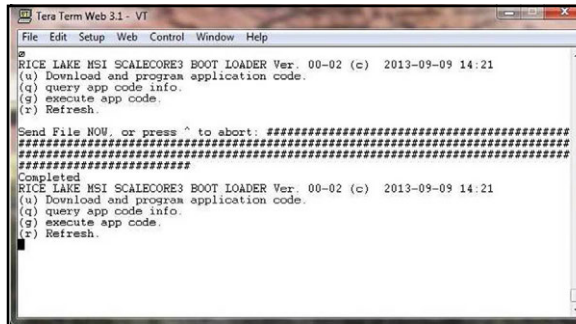

Figure 8-5. Bootloader Menu

8. Verify the Application Code Version, type q to query app code info.
 - App Code Version: 03b03



NOTE: Contact Rice Lake Weighing Systems for the current version.

```

Tera Term Web 3.1 - VT
File Edit Setup Web Control Window Help
RICE LAKE MSI SCALECORE3 BOOT LOADER Ver. 00-02 (c) 2013-09-09 14:21
(u) Download and program application code.
(q) query app code info.
(g) execute app code.
(x) Refresh.

Send File NOW, or press ^ to abort: #####
#####

Completed
RICE LAKE MSI SCALECORE3 BOOT LOADER Ver. 00-02 (c) 2013-09-09 14:21
(u) Download and program application code.
(q) query app code info.
(g) execute app code.
(x) Refresh.

Computed Signature: DD068827
Received Signature: DD068827
Product ID: 01
Product Version ID: 02
App Code Version: 03b03
  
```

Figure 8-6. Query App Code Info

9. Type g to execute the application code, the MSI-3460 display will return to normal **Weigh** mode.



Figure 8-7. Normal Weigh Mode

8.4 MSI-3460 Challenger 3 Dimensions

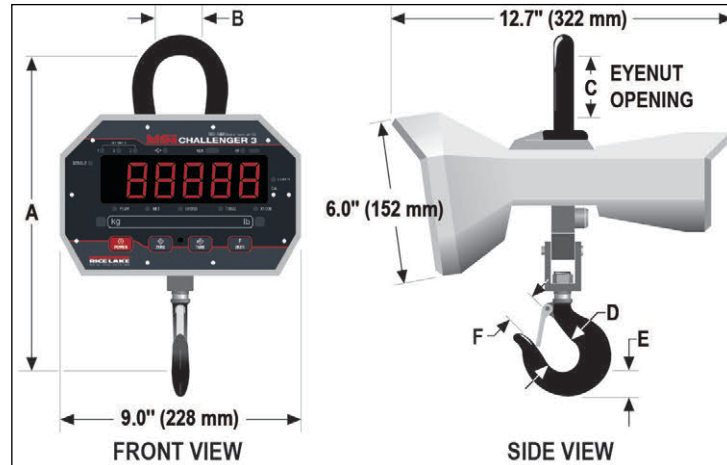

Figure 8-8. MSI-3460 Challenger 3 Dimensions



NOTE: 15,000 lb (7,000 kg) unit comes standard with 12-ton top shackle.

Capacity	Resolution	A	B	C	D	E	F	Approximate Shipping Weight
250 lb	0.1 lb	11.94 in	2.0 in	2.45 in	1.63 in	1.14 in	1.16 in	22 lb
125 kg	0.05 kg	303 mm	51 mm	62 mm	41 mm	29 mm	29 mm	10 kg
500 lb	0.2 lb	11.94 in	2.0 in	2.45 in	1.63 in	1.14 in	1.16 in	22 lb
250 kg	0.1 kg	303 mm	51 mm	62 mm	41 mm	29 mm	29 mm	10 kg
1,000 lb	0.5 lb	11.94 in	2.0 in	2.45 in	1.63 in	1.14 in	1.16 in	22 lb
500 kg	0.2 kg	303 mm	51 mm	62 mm	41 mm	29 mm	29 mm	10 kg
2,000 lb	1.0 lb	11.94 in	2.0 in	2.45 in	1.63 in	1.14 in	1.16 in	22 lb
1,000 kg	0.5 kg	303 mm	51 mm	62 mm	41 mm	29 mm	29 mm	10 kg
5,000 lb	2.0 lb	16.67 in	2.45 in	3.40 in	2.5 in	1.81 in	1.61 in	39 lb
2,500 kg	1.0 kg	423 mm	62 mm	86 mm	64 mm	46 mm	41 mm	18 kg
10,000 lb	5.0 lb	16.67 in	2.45 in	3.40 in	2.5 in	1.81 in	1.61 in	39 lb
5,000 kg	2.0 kg	423 mm	62 mm	86 mm	64 mm	46 mm	41 mm	18 kg
15,000 lb	5.0 lb	21.65 in	3.25 in	4.28 in	3 in	2.26 in	2.08 in	67 lb
7,000 kg	2.0 kg	423 mm	62 mm	86 mm	64 mm	46 mm	41 mm	18 kg

Table 8-2. MSI-3460 Challenger 3 Dimensions

9.0 Specifications

Accuracy

± (0.1% +1 d) of applied load

Capacity

NTEP: 250 X 0.1 lb
 500 X 0.2 lb
 1,000 X 0.5 lb
 2,000 X 1.0 lb
 5,000 X 2.0 lb
 10,000 X 5.0 lb

OIML: 250 X 0.1 kg
 1,000 X 0.5 kg
 2,500 X 1 kg
 5,000 X 2 kg

Industrial: 250 to 15,000 lb (125 to 7,000 kg)

Resolution

2,000 to 3,750 d standard (Up to 10,000 d available)

Enclosure

NEMA Type 4, IP65, powder coated cast aluminum

Lifting Eye & Hook

Crosby® or equivalent with 360° non-bearing swivel hook

Design Overload

200% Safe / 500% Ultimate

Functions

Power

Turns unit ON or OFF

Zero

Zeros applied load up to 100% of capacity (limited range in NTEP/OIML configurations)

Tare

Tares applied load and displays weight in NET mode

User

Programmable as TEST, UNITS, NET/GROSS, TOTAL, PEAK HOLD & SETPOINTS

Display

5-digit, 1.5 in (38 mm) LED with programmable color and brightness control

Displayable Units

Pounds or kilograms selectable

Annunciators

COZ, NET, GROSS, Total, Peak, Low Battery, lb/kg, STABLE, Setpoints, ACK IN, ACK OUT, RF

Power

6 V rechargeable battery; 115/230 VAC battery charger is included

Operating Time

Up to 80 hours between charging with typical use; Less with optional RF Model

Operating Temperature

Legal: 14°F to 104°F (-10°C to 40°C)

Industrial: -40°F to 104°F (-40°C to 40°C)

Auto-Off Mode

Select for 15, 30, 45, 60 minutes or Off

Auto Sleep Mode

Power down during non-use and power up with weight change or any key press

Service Counters

Counts number of lifts over percentage of capacity and lifts over capacity

Calibration

Digital

Filtering

OFF, LO, HI-1, HI-2 selectable

Warranty

One-year limited

Approvals



NTEP

CoC Number 86-021

Accuracy Class III; n_{max} : 2,000 to 2,500 (up to 10,000 lb)



OIML

File Number: R76/2006-A-NL1-21.36

Accuracy Class: III; n_{max} : ≤2500

Capacity Range: 250 ≤ Max ≤ 5000



NOTE: The MSI-3460 scale has a safe mechanical overload of 200%, and an ultimate overload of 500%. Overloads greater than 500% may result in structural failure and dropped loads.

Dropped loads may cause serious personal injury or death.



© Rice Lake Weighing Systems Content subject to change without notice.

230 W. Coleman St. • Rice Lake, WI 54868 • USA
U.S. 800-472-6703 • Canada/Mexico 800-321-6703 • International 715-234-9171 • Europe +31 (0)26 472 1319