

## 1280 Enterprise Series

# Dual Serial Interface Card Installation

The Serial Interface Card (PN 164685) provides two additional serial ports to the 1280 that can connect with either RS-232 or RS-485.



Manuals can be viewed and downloaded from the Rice Lake Weighing Systems website at [www.ricelake.com](http://www.ricelake.com)

Warranty information can be found on the website at [www.ricelake.com/warranties](http://www.ricelake.com/warranties)

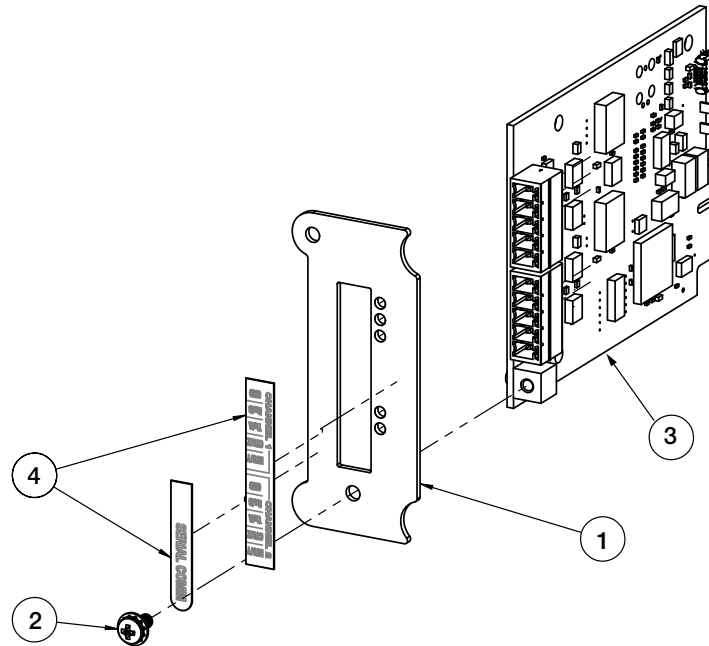

Figure 1. Serial Expansion Card Kit

Item No.	Part No.	Description	Qty
1	164678	Face Plate, Option Card	1
2	14822	Screw, Mach 4-40 NCx1/4	1
4	162930	Board Assembly, 1280 Dual Com	1
5	167194	Label, Serial Opt 1280	1

Table 1. Serial Expansion Card Kit Parts List

The included parts kit contains items used for installation of the card. Items listed for stud grounding of the shields pertain to the panel mount enclosure. See the 1280 technical manual for more information on shield grounding.

Part No.	Description	Qty
14621	Nut, Kep 6-32NC Hex (used for stud grounding)	2
14822	Screw, Mach 4-40 NC x 1/4 (secures card to controller assembly)	1
15130	Washer, Lock NO 6 Type A (used for stud grounding)	2
153882	Conn, 5 Pos Screw Terminal (interface connector)	2
15631	Cable Tie, 3 inch Nylon (secures cable in panel mount installation)	4
53075	Clamp, Ground Cable Shield (used for stud grounding)	2
94422	Label, Capacity .40 X 5.00 (used with serial scales)	2

Table 2. Parts Kit (PN 164692)



Use the following instructions to install and configure the serial option card.



**WARNING** Always disconnect power before opening the indicator. Option card is not hot swappable.



**CAUTION** Use a wrist strap to ground yourself and protect components from electrostatic discharge (ESD) when working inside the indicator enclosure.

1. Open the indicator as instructed in the 1280 technical manual.
2. Remove a slot cover plate from the controller assembly to open a slot for the card.
3. Remove protective tape from pins J3 on the option card prior to installation. Make sure the pins are clean of any sticky residue by carefully wiping with rubbing alcohol.
4. Align the card to the slot; the screw hole in the faceplate of the card should align with the screw hole on the controller assembly.
5. Slide the card into the top and bottom grooves of the slot. Push the card until it is securely seated in the back plane.
6. Secure with screw 4-40 NC x 1/4 (provided).
7. Make connections to the option card. See Figure 3 and Table 4.

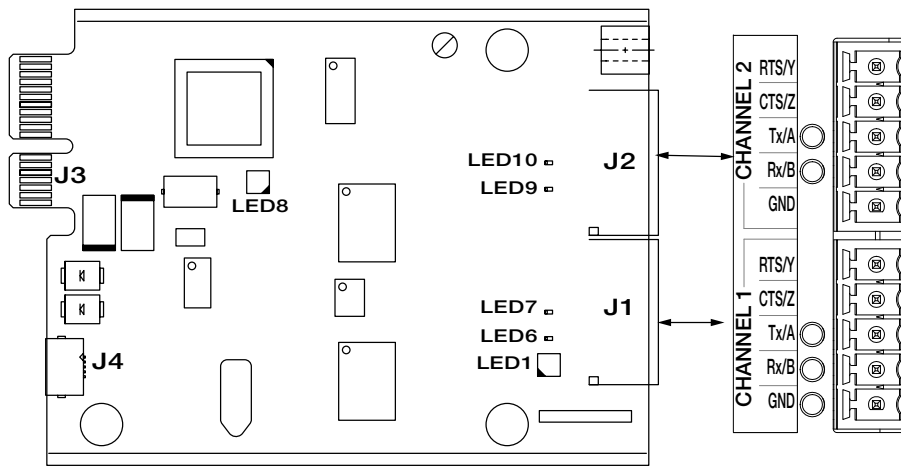

Figure 3. Serial Card Expansion Board

J1	Port (x1)	J2	Port (x2)
Pin 1	GND	Pin 1	GND
Pin 2	RX/B	Pin 2	RX/B
Pin 3	TX/A	Pin 3	TX/A
Pin 4	CTS/Z	Pin 4	CTS/Z
Pin 5	RTS/Y	Pin 5	RTS/Y

Table 4. Pin Assignments for RS-232/RS-485





**Note** The slot of the controller assembly that is selected for the installation of the card will determine the serial ports available.

- Slot 1 = Serial Port 5 and 6
- Slot 2 = Serial Port 7 and 8
- Slot 3 = Serial Port 9 and 10
- Slot 4 = Serial Port 11 and 12
- Slot 5 = Serial Port 13 and 14
- Slot 6 = Serial Port 15 and 16

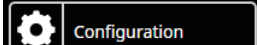
8. Use cable ties from the parts kit to secure loose cables inside the enclosure as needed. Ensure no excess or loose cable is left inside the enclosure.
9. Ground the shield cable using the ground washer in the metal cord grip, or use the grounding stud on the enclosure with cable clamp included in the parts kit. See the 1280 technical manual for more information.
10. Tighten cord grips. Ensure cord grip nut is also tight.

11. Reassemble and power the indicator.
12. Press  on the weigh mode screen. The *Main Menu* will display.
13. Press  for access to the Configuration menu.

 **Note** Access to the Configuration menu may be restricted. Refer to the 1280 technical manual for more information.

14. To configure the serial expansion card, select  to enter the communications menu.
15. Select the serial port to be used from the selection field drop down list, and configure the port and input type needed.
16. Select  to enter the format menu.
17. Set the print and stream Format parameters as needed.

## LED Status Indicators

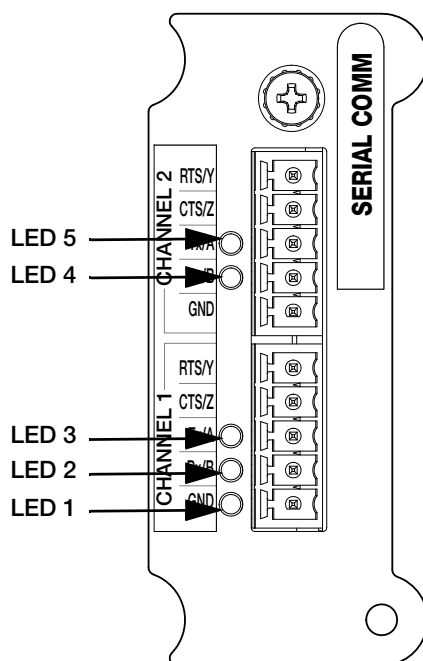

Figure 5. Serial Card Faceplate

LED	Status
1	Green flashing indicates card it is working. Red indicates it is faulty
2	Green flashing when data is received on Channel 1
3	Green flashing when data is transmitted on Channel 1
4	Green flashing when data is received on Channel 2
5	Green flashing when data is transmitted on Channel 2

Table 6. LED Status Lights

## Specifications

Serial Ports	Channels 1 and 2 support RS-232 or RS-485
Serial Type	Compatible with RS-232, RS-422 and RS-485
Baud Rates	1200, 2400, 4800, 9600, 19200, 38400, 57600, 115200
Input Protection	Short circuit protection, 300W transient voltage suppression protection for ESD, EFT (600W transient voltage suppression), tertiary lightning, and system-generated transients per IEC 60001-4-2, 60001-4-4, and 60001-4-5; European Standards EN50082 and EN61000-4



**RICE LAKE**<sup>®</sup>  
WEIGHING SYSTEMS

© Rice Lake Weighing Systems Specifications subject to change without notice.  
Rice Lake Weighing Systems is an ISO 9001 registered company.

230 W. Coleman St. • Rice Lake, WI 54868 • USA  
U.S. 800-472-6703 • Canada/Mexico 800-321-6703 • International 715-234-9171 • Europe +31 (0)26 472 1319

---

**[www.ricelake.com](http://www.ricelake.com)**