

1280 FlexWeigh Systems

Decumulative Concrete Batcher

Operation Manual



© Rice Lake Weighing Systems. All rights reserved.

Rice Lake Weighing Systems® is a registered trademark of
Rice Lake Weighing Systems.

All other brand or product names within this publication are trademarks or
registered trademarks of their respective companies.

All information contained within this publication is, to the best of our knowledge, complete and
accurate at the time of publication. Rice Lake Weighing Systems reserves the right to make
changes to the technology, features, specifications and design of the equipment without notice.

The most current version of this publication, software, firmware and all other product
updates can be found on our website:

www.ricelake.com

Revision History

This section tracks and describes manual revisions for awareness of major updates.

Revision	Date	Description
A	September 27, 2022	Initial manual release with product launch
B	December 8, 2023	Product name change
C	May 7, 2024	Menu update

Table i. Revision Letter History



Technical training seminars are available through Rice Lake Weighing Systems. Course descriptions and dates can be viewed at www.ricelake.com/training or obtained by calling 715-234-9171 and asking for the training department.

Contents

1.0	Introduction	7
1.1	Safety	7
1.2	FCC Compliance	8
1.3	Product Dimensions	8
1.4	Key Functions	9
2.0	Installation	10
2.1	Unpacking	10
2.2	Enclosure Disassembly	10
2.3	Option Cards	10
2.4	Cable Connections	10
2.4.1	Cable Grounding	10
2.4.2	Concrete Batcher Wiring	11
2.4.3	Scale Wiring	12
2.4.4	Digital I/O Wiring	12
2.4.5	Serial Port Wiring	14
2.4.6	Relay Wiring	15
2.4.7	Terminal Wiring	15
2.5	Parts Kit	16
2.6	Replacement Parts	16
3.0	Setup Menu	17
3.1	Setup Menu	17
3.2	Digital I/O Test Screen	18
3.2.1	Activating Outputs	18
3.2.2	Testing Inputs	18
3.3	Global Settings	19
3.4	Water Settings	20
3.5	Mix Design Database	20
3.5.1	Add Mix	21
3.5.2	Edit Mix	21
3.5.3	Delete Mix	21
3.6	Customer Database	21
3.7	Import/Export	22
3.7.1	Import Database	22
3.7.2	Export Database	22
3.8	Clear Transactions Database	23
3.9	Admixture Settings	23
3.10	Scale Settings	24
4.0	Operation	25
4.1	Main Interface	25
4.2	Selecting a Mix	26
4.3	Editing Batch Amount	26
4.4	Editing Moisture Values	26
4.5	Editing a Mix (Load)	27
4.6	Selecting a Customer	27
4.7	Edit Truck	28



Rice Lake continually offers web-based video training on a growing selection of product-related topics at no cost. Visit www.ricelake.com/webinars

4.8 Starting a Batch 28

 4.8.1 System Process Controls 28

4.9 Processing a Mix 29

 4.9.1 System Discharge Sequence 29

4.10 Manual Mode 30

4.11 Bin Vibrator/Cement Aeration 30

5.0 Appendix 31

 5.1 Database Tables 31

 5.1.1 Transactions (“Trans”) Database Table — 1,000 Records 31

 5.1.2 Mix Design (“Mix”) Database Table — 1,000 Records 32

 5.1.3 Customers (“Customer”) Database Table — 500 Records 32

 5.1.4 Language (“Language”) Database Table — 300 Records 32

 5.2 Hardware Setup 32

 5.2.1 Serial Port Functions 32

 5.3 Serial Communications 33

 5.3.1 Weigh Ticket 33

 5.4 System Discharge Sequence 34

 5.4.1 Before Discharge Sequence 34

 5.4.2 During Discharge Sequence 34

 5.4.3 Tail Water Sequence 35

6.0 Specifications 36



Technical training seminars are available through Rice Lake Weighing Systems. Course descriptions and dates can be viewed at www.ricelake.com/training or obtained by calling 715-234-9171 and asking for the training department.



Rice Lake continually offers web-based video training on a growing selection of product-related topics at no cost. Visit www.ricelake.com/webinars

1.0 Introduction

This manual is intended to guide users through the process of selecting and editing concrete batch mix formulas on the 1280 FlexWeigh Decumulative Concrete Batcher. Additional information and features of the 1280 indicator are available in the 1280 Technical Manual (PN 167659).



Manuals are available from Rice Lake Weighing Systems at www.ricelake.com/manuals

Warranty information is available at www.ricelake.com/warranties

1.1 Safety

Safety Definitions:



DANGER: Indicates an imminently hazardous situation that, if not avoided, will result in death or serious injury. Includes hazards that are exposed when guards are removed.



WARNING: Indicates a potentially hazardous situation that, if not avoided, could result in serious injury or death. Includes hazards that are exposed when guards are removed.



CAUTION: Indicates a potentially hazardous situation that, if not avoided, could result in minor or moderate injury.



IMPORTANT: Indicates information about procedures that, if not observed, could result in damage to equipment or corruption to and loss of data.

General Safety

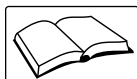

Do not operate or work on this equipment unless this manual has been read and all instructions are understood. Failure to follow the instructions or heed the warnings could result in injury or death. Contact any Rice Lake Weighing Systems dealer for replacement manuals.



WARNING

Failure to heed could result in serious injury or death.

Some procedures described in this manual require work inside the indicator enclosure. These procedures are to be performed by qualified service personnel only.

Do not allow minors (children) or inexperienced persons to operate this unit.

Do not operate without enclosure completely assembled.

Do not place fingers into slots or possible pinch points.

Do not use this product if any of the components are cracked.

Do not make alterations or modifications to the unit.

Do not remove or obscure warning labels.

Do not submerge.

Before opening the unit, ensure the power cord is disconnected from the power source.

Disconnect all power before servicing. Multiple power sources may be present. Failure to do so may cause property damage, personal injury or death.

For permanently connected equipment, a readily accessible disconnect device shall be incorporated in the building installation wiring.

Pluggable units must be installed near the socket/outlet and be easily accessible.

Use copper or copper-clad aluminum conductors only.

1.2 FCC Compliance

United States

This equipment has been tested and found to comply with the limits for a Class A digital device, pursuant to Part 15 of the FCC Rules. These limits are designed to provide reasonable protection against harmful interference when the equipment is operated in a commercial environment. This equipment generates, uses and can radiate radio frequency energy and, if not installed and used in accordance with the instruction manual, may cause harmful interference to radio communications. Operation of this equipment in a residential area is likely to cause harmful interference in which case the user will be required to correct the interference at his own expense.

Canada

This digital apparatus does not exceed the Class A limits for radio noise emissions from digital apparatus set out in the Radio Interference Regulations of the Canadian Department of Communications.

Le présent appareil numérique n'émet pas de bruits radioélectriques dépassant les limites applicables aux appareils numériques de la Class A prescrites dans le Règlement sur le brouillage radioélectrique édicté par le ministère des Communications du Canada.

1.3 Product Dimensions

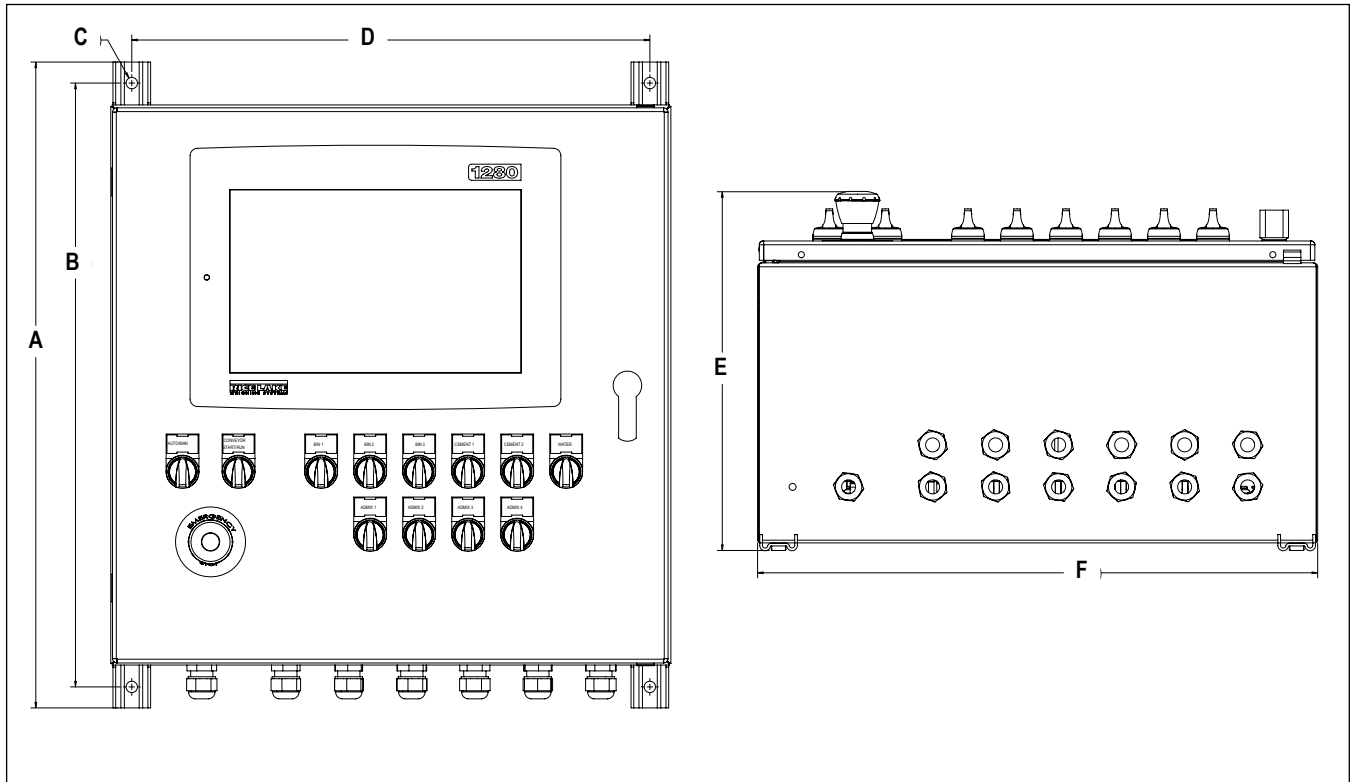

Figure 1-1. 1280 FlexWeigh Decumulative Concrete Batcher Dimensions

A	B	C	D	E	F
23.06 in (585.724 mm)	21.56 in (547.624 mm)	Ø 0.41 in (10.41 mm)	18.50 in (469.9 mm)	12.81 in (325.374 mm)	20 in (508 mm)

Table 1-1. 1280 FlexWeigh Decumulative Concrete Batcher Dimensions

1.4 Key Functions

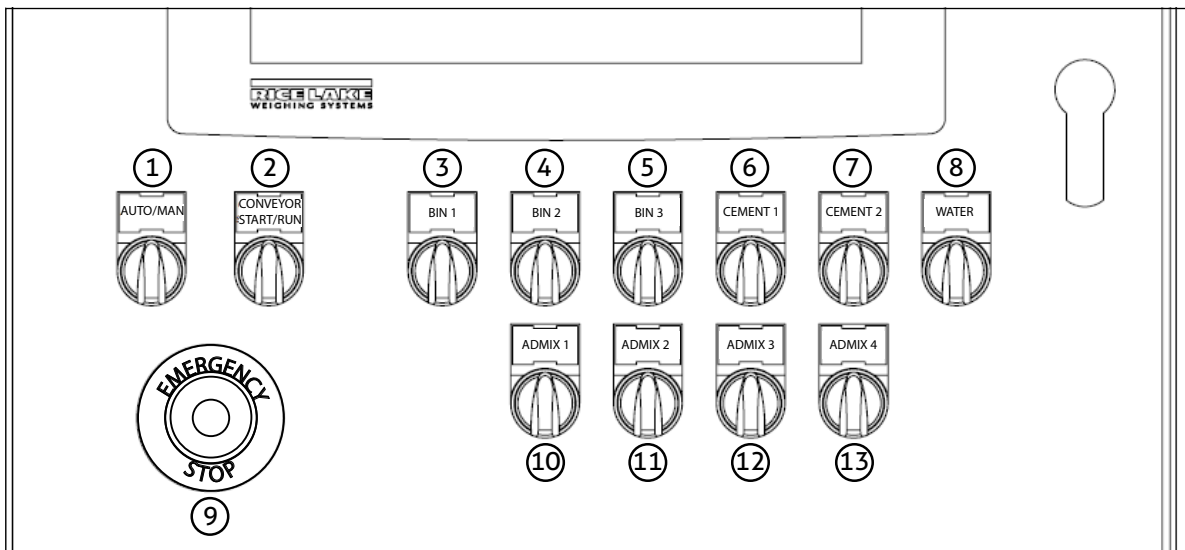

Figure 1-2. Front Panel Keys

Number	Key	Function
1	Auto/Manual	Toggles system control from Automatic to Manual. None of the front panel switches have power until switch is in Manual position. 1280 screen turns dark gray to signify system is in Manual mode. See Section 4.10 on page 30 .
2	Conveyor Start/Run	Turns conveyor on in Manual Mode
3	Bin 1	Activates Bin 1 relay in Manual mode
4	Bin 2	Activates Bin 2 relay in Manual mode
5	Bin 3	Activates Bin 3 relay in Manual mode
6	Cement 1	Activates Cement 1 relay in Manual mode
7	Cement 2	Activates Cement 2 relay in Manual mode
8	Water	Activates Water relay in Manual mode
9	E-Stop	Pauses batching operation and removes power from the relays
10	Admix 1	Activates Admix 1 relay in Manual mode
11	Admix 2	Activates Admix 2 relay in Manual mode
12	Admix 3	Activates Admix 3 relay in Manual mode
13	Admix 4	Activates Admix 4 relay in Manual mode

Table 1-2. Key Functions

2.0 Installation

This section describes procedures for the installation of the 1280 FlexWeigh Decumulative Concrete Batcher.



Always use caution when handling electrostatic sensitive devices (ESD).



CAUTION: Electrostatic sensitive device (ESD), observe handling precautions to prevent shock or damage caused from electrostatic discharge.



WARNING: Procedures requiring work inside the indicator must be performed by qualified service personnel only.

WARNING: Use a wrist strap for protection and causing potential damage components from electrostatic discharge (ESD) when working inside the indicator enclosure.

2.1 Unpacking

Immediately after unpacking, visually inspect the 1280 FlexWeigh Decumulative Concrete Batcher to ensure all components are included and undamaged. The shipping carton should contain the concrete batcher unit, parts kit, any options ordered with the unit and the appropriate manuals. If any parts were damaged in shipment, notify Rice Lake Weighing Systems and the shipper immediately.

2.2 Enclosure Disassembly

The 1280 FlexWeigh Decumulative Concrete Batcher enclosure must be opened to connect cables.

Ensure power to the indicator is disconnected, then open the enclosure.

2.3 Option Cards

Table 2-1 lists the option cards that are used in the 1280 FlexWeigh Decumulative Concrete Batcher.

Slot	Type
1	Dual Channel A/D Card
2	Single Channel A/D Card (Only used if a 5-scale system is required)
3	Currently Not Used
4	Dual Channel A/D Card
5	24-channel DIO Card

Table 2-1. Option Card Locations

2.4 Cable Connections

The 1280 FlexWeigh Decumulative Concrete Batcher provides 13 cord grips for cabling into the controller. The parts kit includes cord grip plugs to prevent moisture from entering the enclosure. Install these plugs into all cord grips that will not be used in your application.

Use the cable grounding instructions for wiring into the indicator.



NOTE: An additional adhesive label (PN 121108) is included in the parts kit and can be installed at the installer's discretion indicating correct terminal block numbering.

2.4.1 Cable Grounding

Cables routed through the cord grips should be grounded against the indicator enclosure. Follow cable grounding instructions in the 1280 Enterprise Series Technical Manual (PN 167659).

2.4.2 Concrete Batcher Wiring

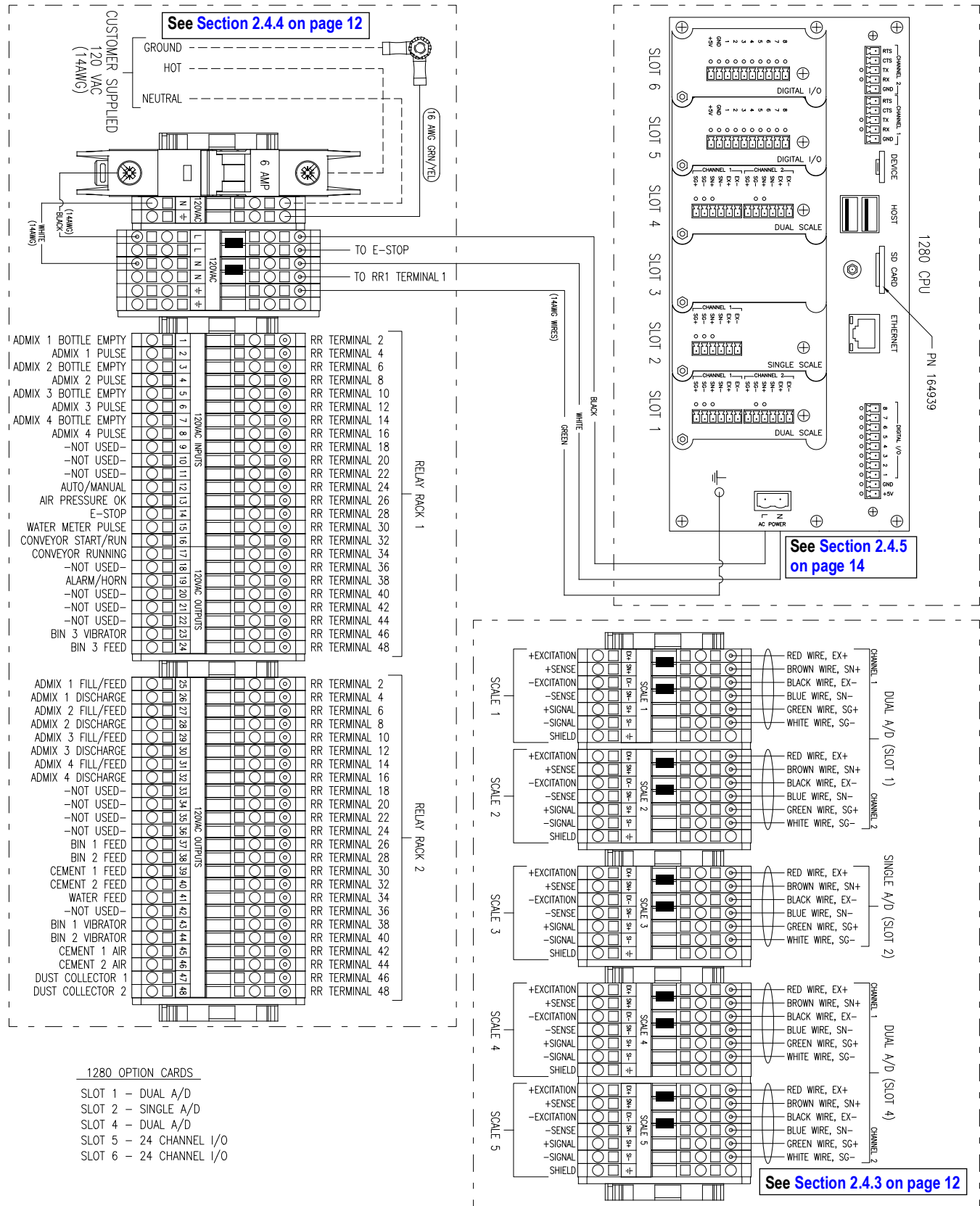

Figure 2-1. 1280 FlexWeigh Decumulative Concrete Batcher Wiring Diagram

2.4.3 Scale Wiring

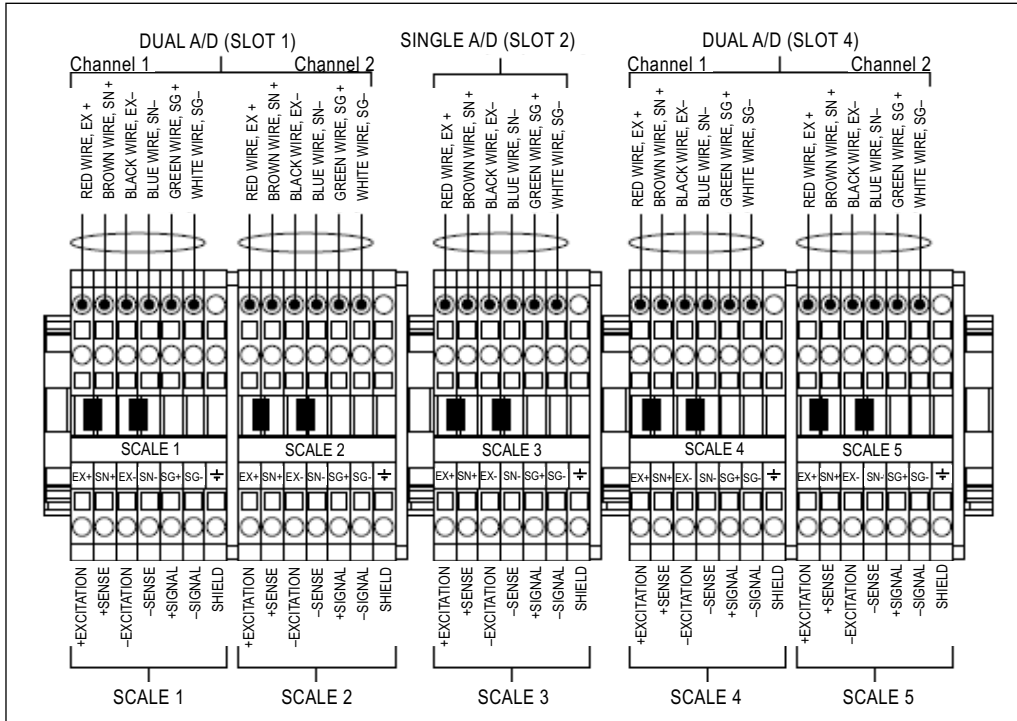

Figure 2-2. Scale Wiring Diagram



NOTE: At least one aggregate scale and one cement scale is needed in a scale configuration. See [Table 2-2](#) for the scales needed in each scale configuration.

Scale Configuration	Aggregate 1 Scale 1	Aggregate 2 Scale 2	Aggregate 3 Scale 3	Cement 1 Scale 4	Cement 2 Scale 5
5 Scale Configuration	X	X	X	X	X
4 Scale Configuration	X	X		X	X
3 Scale A Configuration	X	X		X	
3 Scale B Configuration	X			X	X
2 Scale Configuration	X			X	

Table 2-2. Scale Wiring Configuration

2.4.4 Digital I/O Wiring

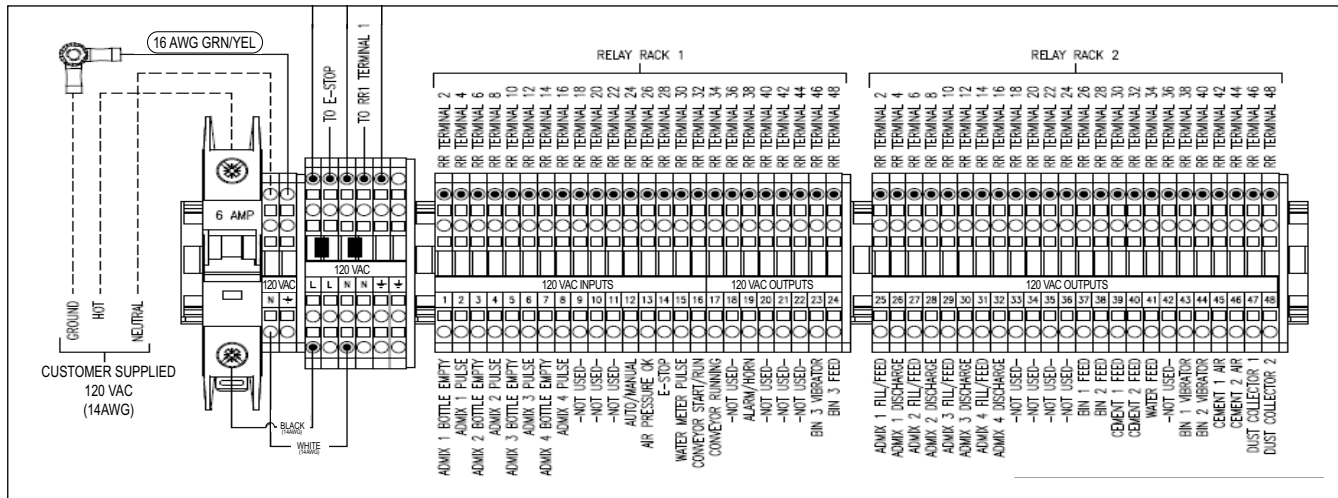

Figure 2-3. Digital I/O Wiring Diagram

Digital I/O Functions

Slot	Bit	Type	Function
0	1-8	Currently Not Used	Currently Not Used
5	1	Programmability	Admixture 1 Bottle Empty
5	2	Programmability	Admixture 1 Pulse
5	3	Programmability	Admixture 2 Bottle Empty
5	4	Programmability	Admixture 2 Pulse
5	5	Programmability	Admixture 3 Bottle Empty
5	6	Programmability	Admixture 3 Pulse
5	7	Programmability	Admixture 4 Bottle Empty
5	8	Programmability	Admixture 4 Pulse
5	9	Currently Not Used	Currently Not Used
5	10	Currently Not Used	Currently Not Used
5	11	Currently Not Used	Currently Not Used
5	12	Programmability	Manual Mode
5	13	Programmability	Air Pressure OK
5	14	Programmability	E-Stop
5	15	Programmability	Water Meter Pulse
5	16	Programmability	Conveyor Running
5	17	Output	Conveyor Start/Run
5	18	Currently Not Used	Currently Not Used
5	19	Output	Alarm/Horn
5	20	Currently Not Used	Currently Not Used
5	21	Currently Not Used	Currently Not Used
5	22	Currently Not Used	Currently Not Used
5	23	Output	Bin 3 Vibrator
5	24	Output	Bin 3 Feed
6	1	Output	Admixture 1 Fill/Feed
6	2	Output	Admixture 1 Discharge
6	3	Output	Admixture 2 Fill/Feed
6	4	Output	Admixture 2 Discharge
6	5	Output	Admixture 3 Fill/Feed
6	6	Output	Admixture 3 Discharge
6	7	Output	Admixture 4 Fill/Feed
6	8	Output	Admixture 4 Discharge
6	9	Currently Not Used	Currently Not Used
6	10	Currently Not Used	Currently Not Used
6	11	Currently Not Used	Currently Not Used
6	12	Currently Not Used	Currently Not Used
6	13	Output	Bin 1 Feed
6	14	Output	Bin 2 Feed
6	15	Output	Cem 1 Feed
6	16	Output	Cem 2 Feed
6	17	Output	Water Feed
6	18	Currently Not Used	Currently Not Used
6	19	Output	Bin 1 Vibrator
6	20	Output	Bin 2 Vibrator
6	21	Output	Cem 1 Air
6	22	Output	Cem 2 Air
6	23	Output	Dust Collector 1
6	24	Output	Dust Collector 2

Table 2-3. Digital I/O Functions

2.4.5 Serial Port Wiring

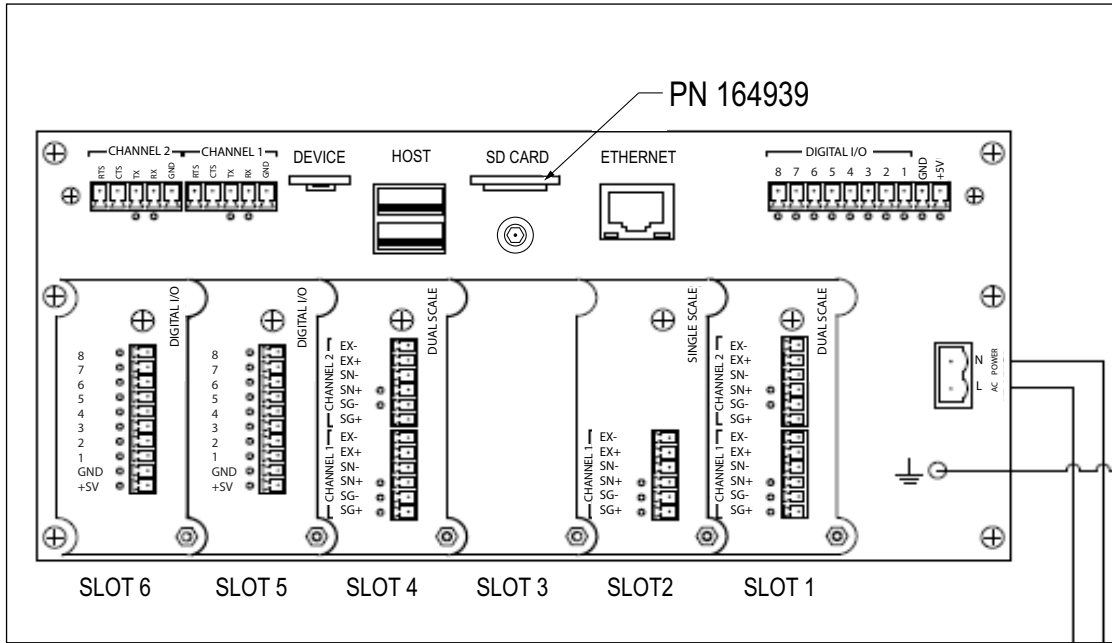

Figure 2-4. Serial Port Wiring Diagram

Port/Channel	Pin	Signal	CPU Connector
1	1	GND	J6
	2	RS-232 RX/RS-485 B	
	3	RS-232 TX/RS-485 A	
	4	RS-232 CTS/RS-485 Z	
	5	RS-232 RTS/RS-485 Y	
2	1	GND	J7
	2	RS-232 RX/RS-485 B	
	3	RS-232 TX/RS-485 A	
	4	RS-232 CTS/RS-485 Z	
	5	RS-232 RTS/RS-485 Y	

Table 2-4. Serial Port Connector Signals

2.4.6 Relay Wiring

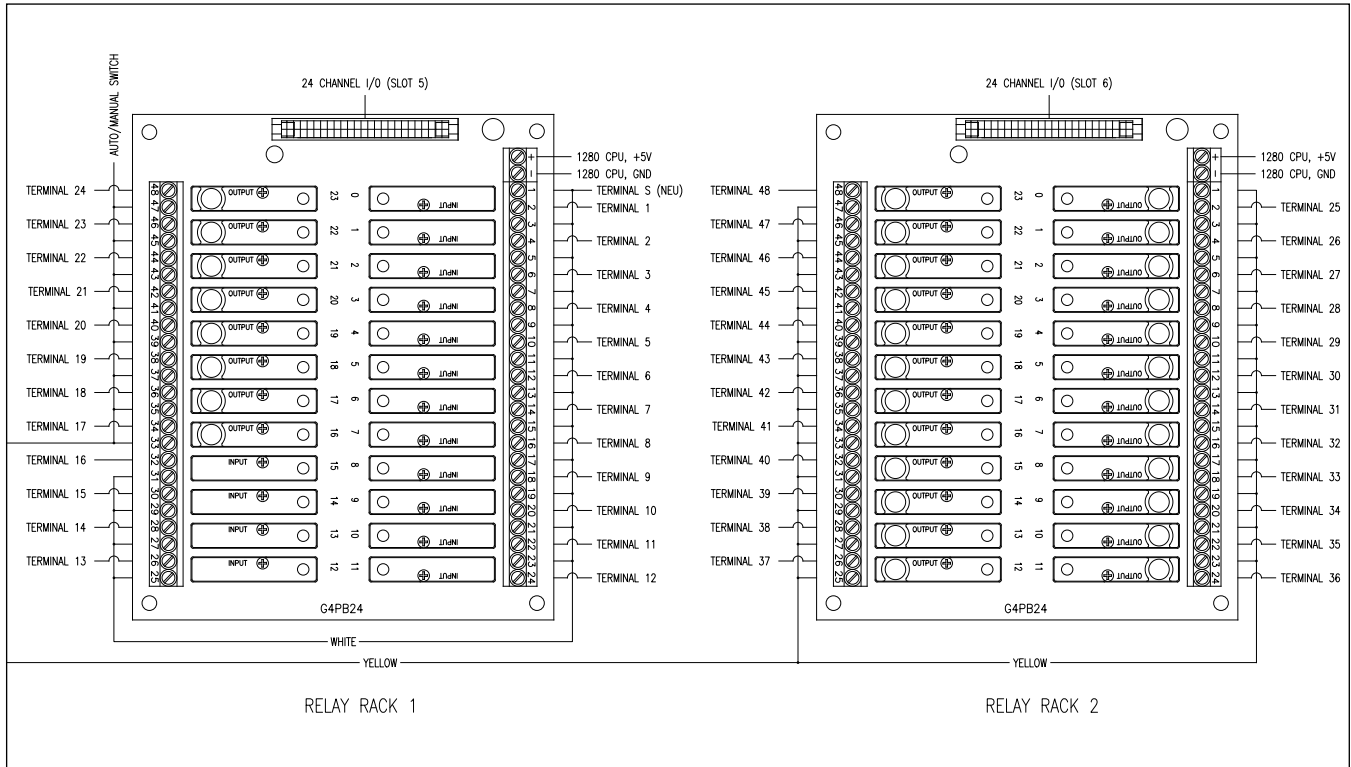

Figure 2-5. 1280 FlexWeigh Decumulative Concrete Batcher Relay Wiring Diagram

2.4.7 Terminal Wiring

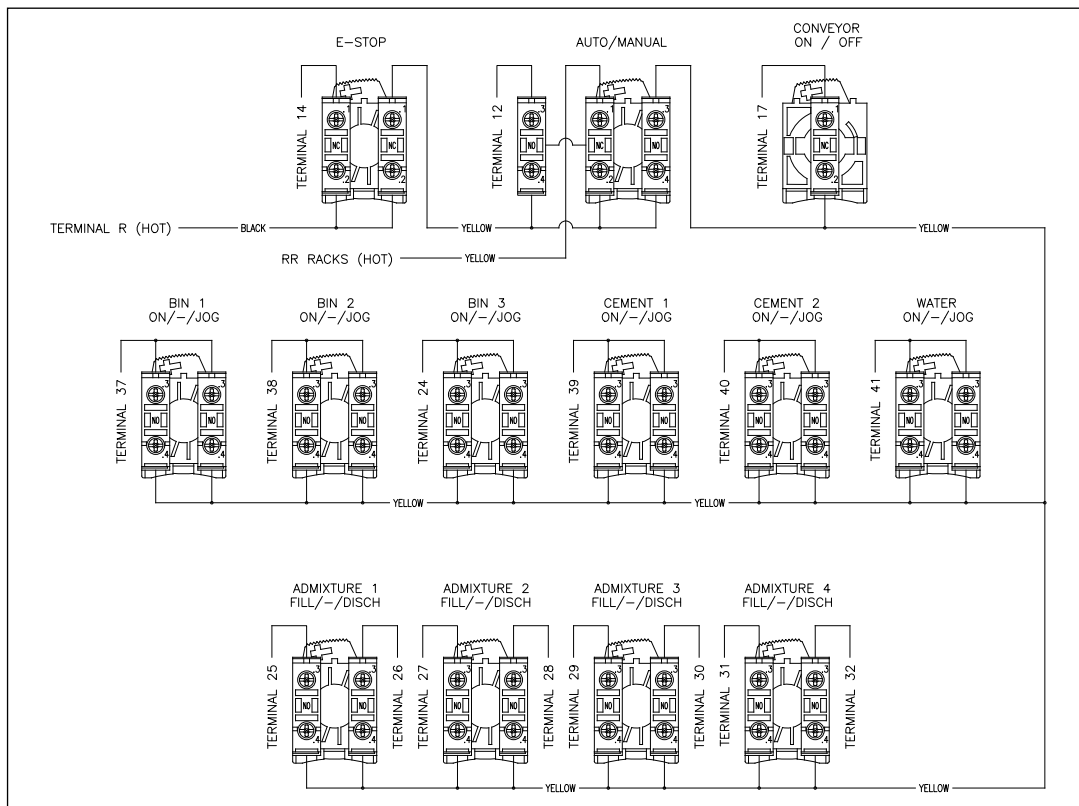

Figure 2-6. 1280 FlexWeigh Decumulative Concrete Batcher Terminal Wiring Diagram

2.5 Parts Kit

Part No.	Description	QTY
14621	Nut, Kep 6-32NC HEX	6
14630	Nut, Lock 10-32NF HEX	4
14877	Screw, MACH 10-32NFx3/8	1
15130	Washer, Lock NO 6 Type A	5
15139	Washer, Lock NO 10 Type A	7
158207	Screw, MACH 6-32x1/4	2
166241	Cable, Antenna Extension	1
168877	Screw, Set #10-32NF x 1	4
169023	Ground Bus Bar	1
17780	Ground Strap, 16 inch Tinned	1
182246	Gasket, Washer Seal	1
182281	Washer Shell, 1/4 inch	1
193810	Ground Cable Clamp Small	2
202845	Wire ASSY, Ground 9 inch	1
206703	Antenna, RP-SMA	1
53075	Clamp, Ground Cable Shield, Radius 0.078 inch	5
67550	Clamp, Ground Cable Shield, Radius 0.125 inch	1

Table 2-5. Parts Kit

2.6 Replacement Parts

Item No.	Part No.	Description
1	196708	1280 Controller
2	198512	Circuit Breaker 6 Amp
3	15628	Cord Grip 1/2 NPT
4	15630	Cord Grip Nut 1/2 NPT
5	30376	Cord Grip Seal Ring Nylon 1/2 NPT
6	33205	Relay Board
7	15971	Output Relay module 12-140V
8	15972	Input Relay module 90-140V
9	94273	E-Stop Button Switch
10	94295	Knob 2 Position Switch
11	94299	Knob 3 Position Spring Return Switch
12	94296	Knob 3 Position Switch
13	94313	NC Contact Block
14	94311	NO Contact Block
15	164085	Single Scale Card
16	164683	Dual Scale Card
17	164684	Digital I/O
18	164939	Memory Card
19	94316	Legend Plate holder

Table 2-6. Replacement Parts List

3.0 Setup Menu

This section describes the various setup parameters for the 1280 FlexWeigh Decumulative Concrete Batcher. Detailed descriptions of the Scale Configuration, Communications, Features, Formats, Digital I/O, Analog Output, Setpoints and Diagnostics menus are provided in the 1280 Enterprise Series Technical Manual (PN 167659).

3.1 Setup Menu

To enter the setup menu.

1. Press  in the bottom right corner of the main display to enter the setup menu.

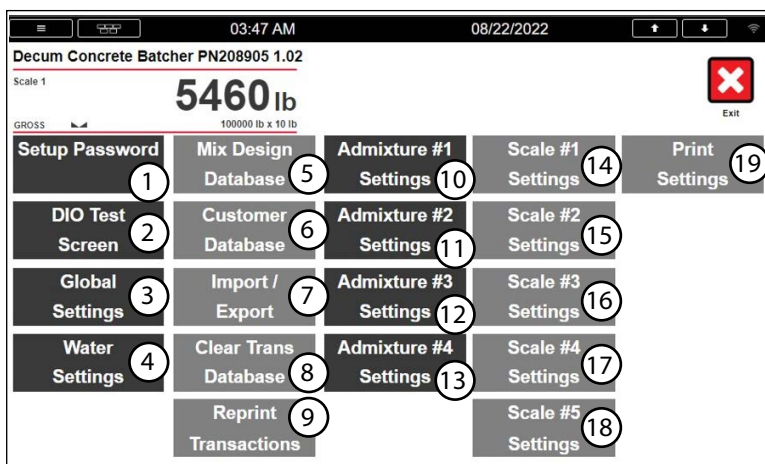

Figure 3-1. 1280 FlexWeigh Decumulative Concrete Batcher Setup Menu

The Setup menu offers access to the following:

Item No.	Selection	Description
1	Setup Password	Modify the system password. Setting password to 0 disables the system password.
2	DIO Test Screen	Test each Digital I/O on the 1280 FlexWeigh Decumulative Concrete Batcher
3	Global Settings	Edit Max Batch Size, Conveyor Runout, Units Mode, Ticket Number, Language Button (allows user to switch between primary and secondary languages, Scale Configuration and Moisture Compensation)
4	Water Settings	Edit Discharge (Before Discharge, During Discharge), County, Tail water %
5	Mix Design Database	Add, edit or delete mix designs
6	Customer Database	Add, edit or delete customers
7	Import/Export	Import the database or export the database to another device
8	Clear Transaction Database	Clear the database for all transactions by selecting Yes or No
9	Reprint Transaction	Select and reprint a previous completed transaction
10	Admixture #1 Settings	Edit Name, Type (None, Bottle, Direct), Discharge (Tail Water, Front Water), County and Coast for Admixture #1
11	Admixture #2 Settings	Edit Name, Type (None, Bottle, Direct), Discharge (Tail Water, Front Water), County and Coast for Admixture #2
12	Admixture #3 Settings	Edit Name, Type (None, Bottle, Direct), Discharge (Tail Water, Front Water), County and Coast for Admixture #3
13	Admixture #4 Settings	Edit Name, Type (None, Bottle, Direct), Discharge (Tail Water, Front Water), County and Coast for Admixture #4
14	Scale #1 Settings	Edit Names, Free falls, Min flow, Vib/air settings (None, Always, No Flow) and Start Delay for Scale #1
15	Scale #2 Settings	Edit Names, Free falls, Min flow, Vib/air settings (None, Always, No Flow) and Start Delay for Scale #2
16	Scale #3 Settings	Edit Names, Free falls, Min flow, Vib/air settings (None, Always, No Flow) and Start Delay for Scale #3
17	Scale #4 Settings	Edit Names, Free falls, Min flow, Vib/air settings (None, Always, No Flow) and Start Delay for Scale #4
18	Scale #5 Settings	Edit Names, Free falls, Min flow, Vib/air settings (None, Always, No Flow) and Start Delay for Scale #5
19	Print Settings	Print all settings in Setup Menu

Table 3-1. Setup Menu Selections

3.2 Digital I/O Test Screen

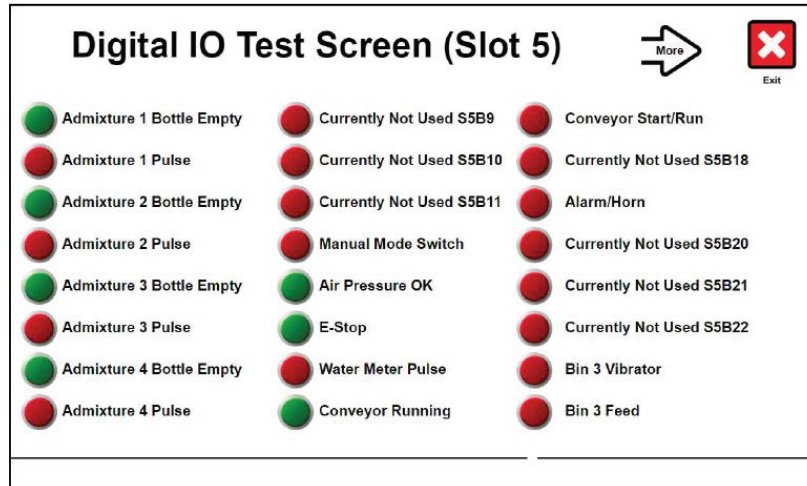

Figure 3-2. Digital I/O Test Screen



WARNING: System Outputs can be activated from this screen. Make sure personnel are clear of connected equipment and/or field power for connected equipment is disconnected.

3.2.1 Activating Outputs

Press output touch widget(s) to verify functionality of connected relay and wiring as needed. When output is set to **ON**, the light changes from red to green. Output will remain on as long as set to **ON** while viewing this screen.

3.2.2 Testing Inputs

Active inputs will show as **ON** while viewing this screen.

3.3 Global Settings

Page 1 of 1



Exit

	Field	Data
①	Maximum Batch Size	10.0
②	Conveyor Runout	5.0 sec
③	Units Mode	Standard
④	Ticket Number	26
⑤	Language	Primary
⑥	Scale Configuration	5 Scale
⑦	Moisture Compensation	Enabled
⑧	Auto Print	Enabled

Figure 3-3. Global Settings Menu

Number	Parameter	Function
1	Maximum Batch Size	Maximum batch size that the batch plant can produce. Value is in Cubic Yards if units is set to Standard, and is in Cubic Meters units is set to Metric.
2	Conveyor Runout	Time in seconds that the conveyor will continue to run after all batch steps are completed.
3	Units Mode	Toggles between Standard and Metric units.
4	Ticket Number	Defines which ticket number to start at for the next print job.
5	Language	Toggles between the Primary or Secondary language.
6	Scale Configuration	Toggles between: 5 Scale, 4 Scale, 3 Scale A, 3 Scale B and 2 Scale system setup. (See Table 2-2 on page 12 for more information on the various scale layouts available.)
7	Moisture Compensation	Toggles between moisture compensation enabled or disabled. When enabled Bin 1, 2 and 3 may have a moisture percentage manually entered and updated.
8	Auto Print	Toggles Auto Print on or off.

Table 3-2. Global Settings Parameter Functions

3.4 Water Settings

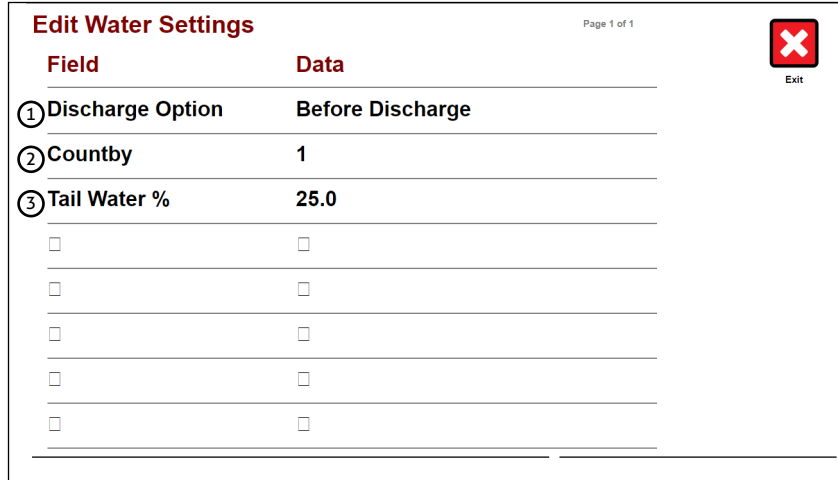

Figure 3-4. Water Settings Screen

Number	Parameter	Function
1	Discharge Option	Toggles between: <ul style="list-style-type: none"> • Before Discharge – Front water is metered out before any material is batched. The timer delay for all scale discharges starts after all front water is metered. • During Discharge – Front water is metered out and material discharges per configured timing. The timer for all scale discharges starts as soon as the batch starts.
2	Country	Defines how many Gallons (or Liters) will be counted per pulse from the water meter.
3	Tail Water %	Percent of water that will be held for tail water.

Table 3-3. Water Setting Parameters

3.5 Mix Design Database

The Mix Design Database interface is used to program and save the concrete batch mixes. Alternatively, the Mix Design Database may be edited on a PC and downloaded to the 1280 FlexWeigh Decumulative Concrete Batcher via USB flash drive or by using Rice Lake Weighing Systems’ program Interchange.

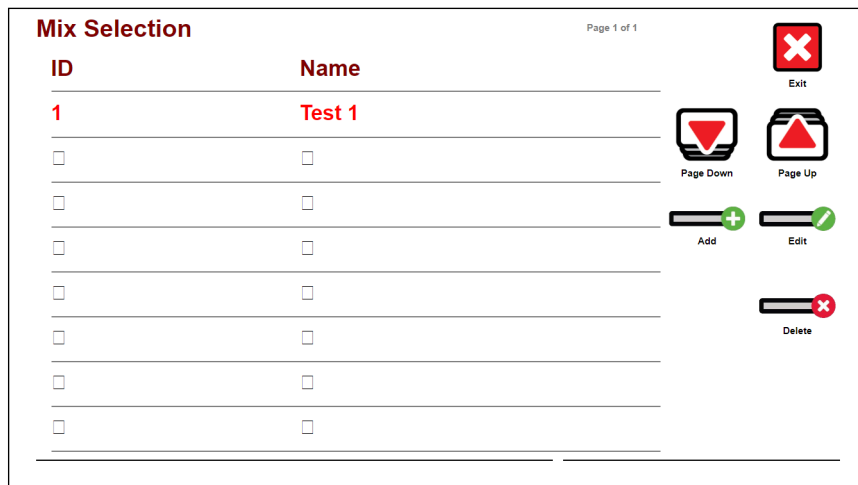

Figure 3-5. Mix Selection Screen

All configured mixes are displayed on this screen.  and  are touch widgets that are used to navigate through the displayed list.

3.5.1 Add Mix

1. Press .
2. Fill in each field as applicable.



IMPORTANT: All target values must be entered for a 1 yard/meter batch size



NOTE: Not all Bins, Cements and Admixtures may be active depending on installed software and system configuration.

3. Press .

3.5.2 Edit Mix

1. Select mix.
2. Press .
3. Edit each field as applicable.



IMPORTANT: All target values must be entered for a 1 yard/meter batch size.



NOTE: Not all Bins, Cements, and Admixtures may be active depending on installed software and system configuration.

4. Press .

3.5.3 Delete Mix

1. Select mix.
2. Press .



IMPORTANT: Mix will be permanently deleted and cannot be recovered from the database.

3.6 Customer Database

The Customer Database interface is used to program and save customers. Alternatively, the Customer Database may be edited on a PC and downloaded to the 1280 FlexWeigh Decumulative Concrete Batcher via USB flash drive or Interchange program. For details on using the Customer Database menu and touch widgets, see [Section 4.6 on page 27](#).

3.7 Import/Export

The Import/Export interface is used to import or export 1280 FlexWeigh Decumulative Concrete Batcher databases to or from a USB flash drive or to the SD Card.

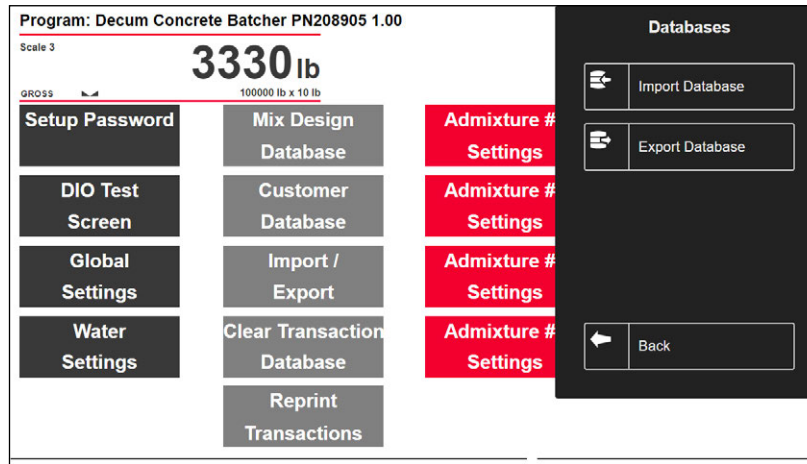

Figure 3-6. Setup Menu with Database Panel Open

3.7.1 Import Database

1. Select  Import Database .

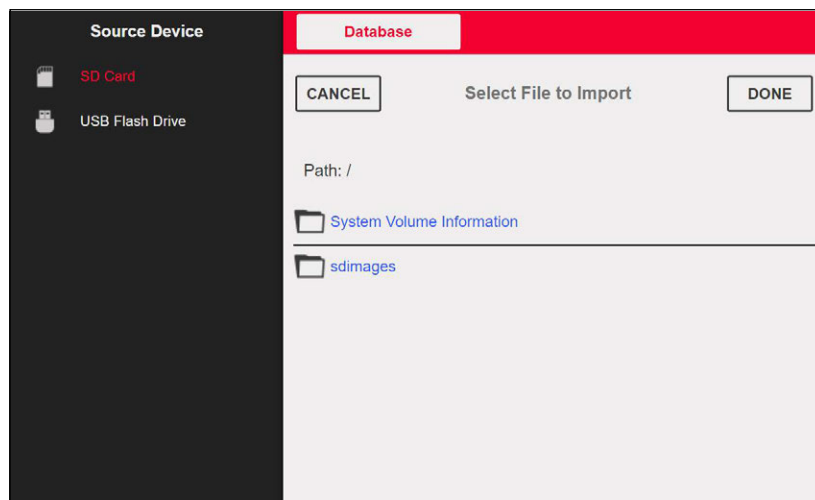





Figure 3-7. File Import Selection

2. Select correct source device from the menu on the left display panel.
3. Navigate to the path where the “.db” database file is stored on the source device.
4. Select  .

3.7.2 Export Database

1. Select  Export Database .
2. Select the correct destination device from the menu on the display panel.
3. Navigate to the path where the databases should be exported to.
4. Select  .

3.8 Clear Transactions Database

Option to clear the Transaction Database on the 1280 FlexWeigh Decumulative Concrete Batcher. Selecting  will clear all Transaction database records. Export records that must be saved before clearing the Transaction Database.

To clear the database:

1. Select .
2. Select .

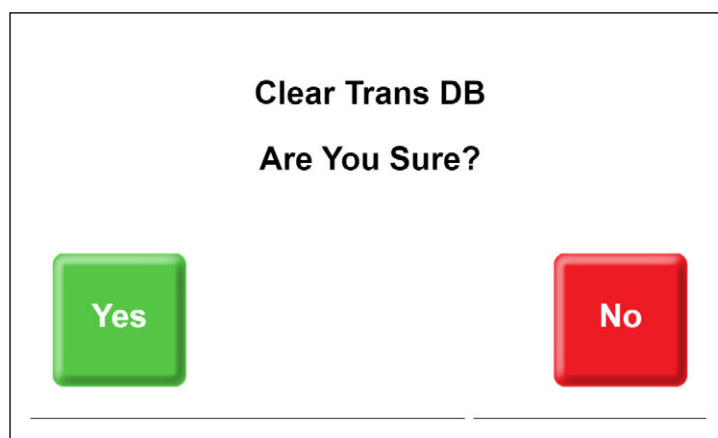
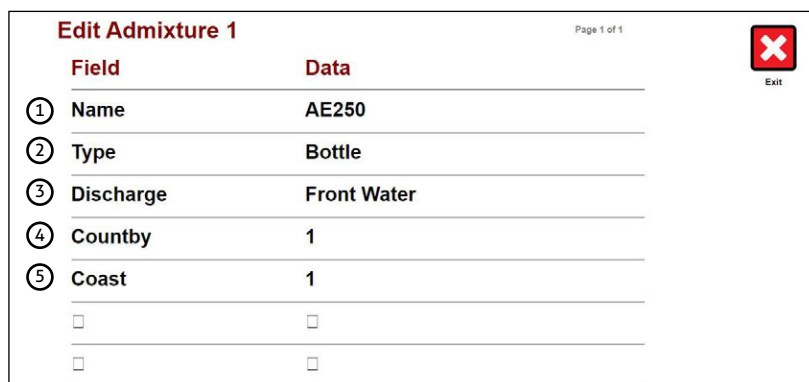

Figure 3-8. Clear Transactions Database Prompt

3.9 Admixture Settings



Edit Admixture 1		Page 1 of 1	
Field	Data		
① Name	AE250		
② Type	Bottle		
③ Discharge	Front Water		
④ Country	1		
⑤ Coast	1		
<input type="checkbox"/>	<input type="checkbox"/>		
<input type="checkbox"/>	<input type="checkbox"/>		

Figure 3-9. Edit Admixture Screen

Item No.	Parameter	Function
1	Name	Name of Admixture
2	Type	Toggles between: None - Admixture is not configured and is not selectable in the Mix design database. Bottle - Admixture is configured to fill a separate container (bottle) before being discharged into the batch. Direct - Admixture is configured to meter directly into the batch.
3	Discharge Option	Toggles between: Front Water - Admixture is discharged along with the front water. Tail Water - Admixture is discharged along with the tail water.
4	Country	Defines how many ounces (or milliliters) will be counted per pulse from the meter.
5	Coast	Defines how many meter pulses ahead of the admixture target to turn off the admixture output.

Table 3-4. Admixture Parameters

3.10 Scale Settings

Page 1 of 1

Edit Scale 1

Field	Data
① Name	Sand
② Freefall	0.0
③ Min Flow	10.0
④ Vibrator/Air	None
⑤ Start Delay	0.0
<input type="checkbox"/>	<input type="checkbox"/>
<input type="checkbox"/>	<input type="checkbox"/>
<input type="checkbox"/>	<input type="checkbox"/>



Exit

Figure 3-10. Scale Data

Item No.	Parameter	Function
1	Name	Name of Scale — See Section 2.4.3 on page 12 for A/D Card (Scale Card) assignment options.
2	Freefall	Defines the amount of weight to subtract from the target weight to turn off the gate output early to account for the material in suspension.
3	Minimum Flow	Defines the flow rate in lb (or kg) per second. A flow rate below this value will activate the Vibrator/Air output if the Vibrator/Air toggle is set to No Flow.
4	Vibrator/Air	Toggles between: Always - Vibrator or air is always on anytime the scale discharge output is on. No Flow - Vibrator or air is only activated if the scale drops below its Minimum Flow setting. None - Vibrator or air is not activated for this scale.
5	Start Delay	Defines how many seconds to delay the scale discharge in the batching sequence. The timer starts based on water settings. See Section 3.4 on page 20 for Water Settings.

Table 3-5. Scale Data Parameters

4.0 Operation

The section describes the basic sequence of operation for the 1280 FlexWeigh Decumulative Concrete Batcher.

4.1 Main Interface

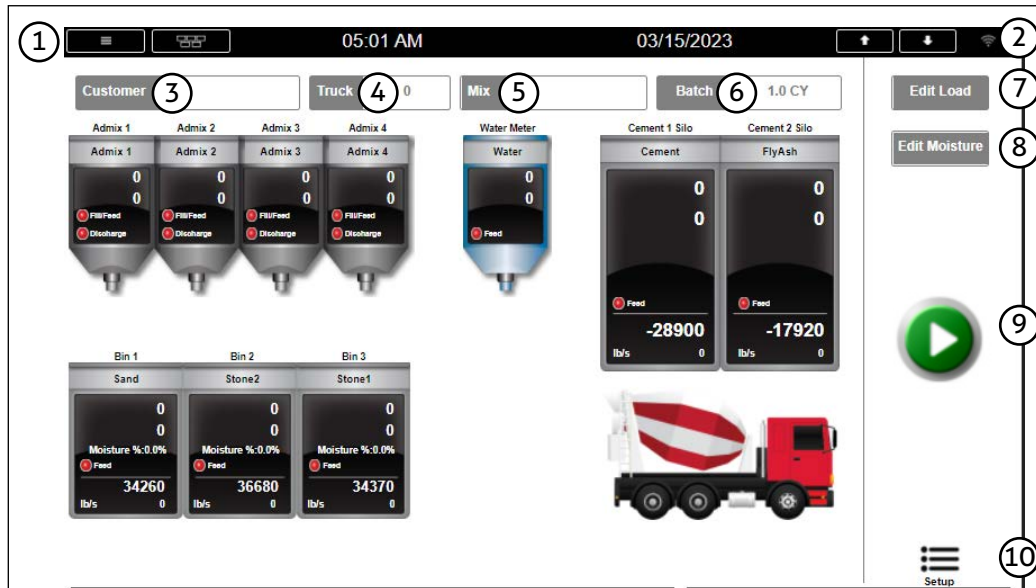

Figure 4-1. Concrete Batcher Main Interface





NOTE: Pressing the current live weight on the active bins or cement silos zeros the scales.

Number	Widget	Description
1	Main Menu	Access and make changes to Configuration. See 1280 Technical Manual (PN 167659) for more details
2	Network Information	Access and view Wired Ethernet, Wi-Fi, Bluetooth® and Wi-Fi Direct information
3	Customer Selection	View and select customers that have been created
4	Truck Selection	Enter truck information
5	Mix Selection	View and select mixes that have been created
6	Batch Selection	Enter new batch size
7	Edit Load	Edit Admixture and Water Values
8	Edit Moisture	Edit the moisture percentage of Bin 1, Bin 2 and Bin 3
9	Start Button	Start the batching process
10	Setup Menu	Access the Setup Menu

Table 4-1. Main Interface Widget Information

4.2 Selecting a Mix

1. Press **Mix**.
2. Press  or  until the desired mix is shown.
3. Press the desired mix.



NOTE: All targets will be multiplied by the Batch Amount and Moisture Content (if enabled).

NOTE: All values are entered in 1 Yard/Meter in the Mix database.

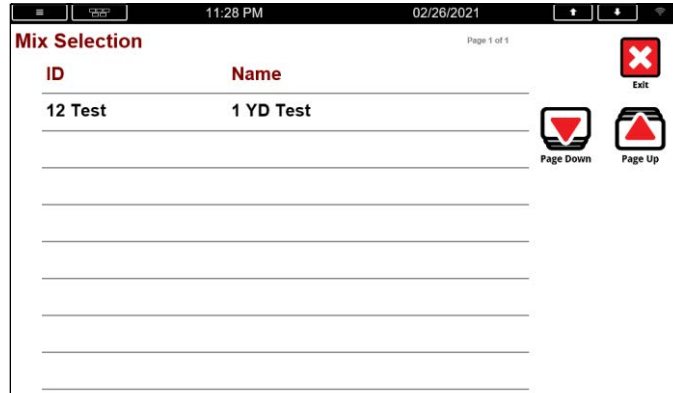

Figure 4-2. Mix Selection

4.3 Editing Batch Amount

1. Press **Batch**.
2. Enter the Batch Size.



NOTE: The batch size must be less than the maximum batch size.

3. Press **DONE**.

4.4 Editing Moisture Values

All mixes are entered in the database as 1 Cubic Yard / Cubic Meter. When adjusting the water, it uses 8.345404 pounds per gallon and 2.204684 kilograms per liter to be subtracted from the target will be determined based on how much moisture was entered.

	Target	Moisture	Adjusted Target	Water
Bin 1	1400 lb	0.70%	1410 lb	1.2 gal
Bin 2	300 lb	1.30%	304 lb	0.5 gal
Bin 3	1200 lb	4.50%	1254 lb	6.5 gal
Water	33.52 gal	N/A	25.30 gal	N/A

Table 4-2. Bin Moisture Values

To edit the moisture value:

1. Press **Edit Moisture**.



NOTE: The widget is only visible if Moisture Compensation is enabled.

2. Enter the Bin 1 moisture percentage followed by .
3. Enter the Bin 2 moisture percentage followed by .
4. Enter the Bin 3 moisture percentage followed by .

4.5 Editing a Mix (Load)

If changes are required to the Admixture or Water values for the load, the **Edit Load** widget may be used. To change the Admixture or Water values:

1. Press .
2. Press each admixture or water to edit the current target.



NOTE: These values will not update the Mix database. The values will remain until a new mix is selected, power is cycled or the Setup Menu is exited.

NOTE: No other options will be available until Exit Load is pressed.

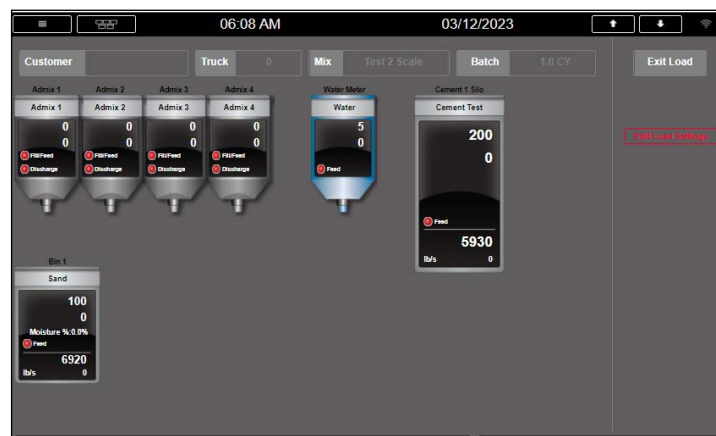

Figure 4-3. Mix (Load) Editing Main Display

3. Press .

4.6 Selecting a Customer



1. Press .
2. Press  or  until the desired customer displays.
3. Select desired customer.









Figure 4-4. Customer Selection Widget

4.7 Edit Truck



To edit the truck ID number:

1. Press  .
2. Enter the Truck ID.
3. Press  .

4.8 Starting a Batch

The Concrete Batcher provides a large **Start** () widget on the main screen. Pressing  changes the widget to **Pause** () when the system is processing a mix. Pressing  causes the system to display large **Resume** () and **Abort** () widgets.

4.8.1 System Process Controls

- Press  or press the **E-Stop** to pause the system when batching has started.
- Press  to start the batching process or resume the process when paused.
- Press  to abort the batching process when paused.



NOTE: The system will add a record to the Transaction database with the amount that was batched before the pause widget was pressed.

NOTE: To deactivate the E-Stop Input, turn the E-Stop Input clockwise.

4.9 Processing a Mix

The **Start** widget will not display if:

- E-Stop is not pulled out
- Air pressure is low
- Admix (X) is not empty (In either the bottle or the mix)
- Bin/Cement (X) does not have enough material
- In Manual Mode



NOTE: If Manual Mode is enabled while batching, the screens, tickets and storage may not reflect the actual amount of material processed.

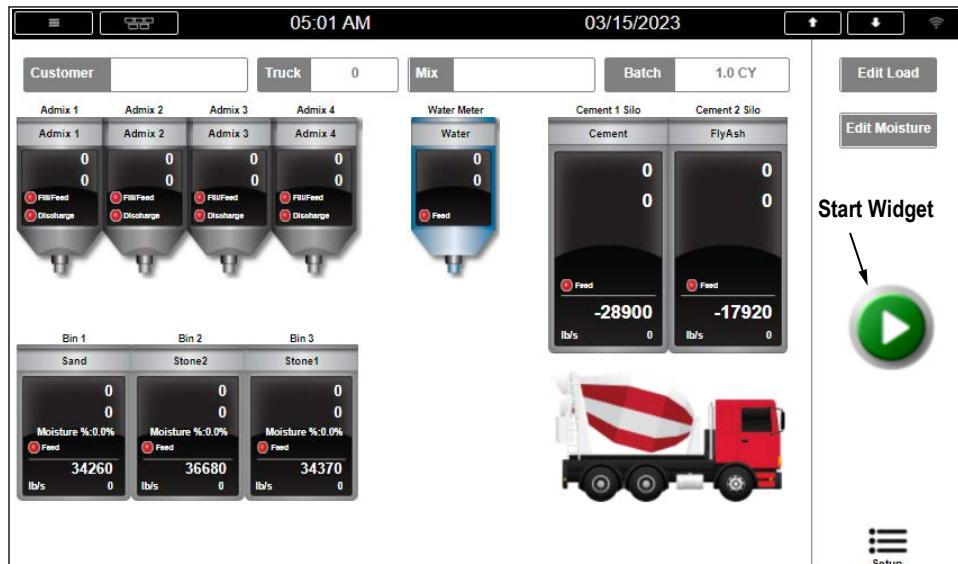

Figure 4-5. Main Batching Screen

To start the batching process:

1. Press .



NOTE: The system waits until the Conveyor Running input is turned ON. If the Conveyor Running input turns OFF before the Conveyor Runout Time is exceeded, the batch will be paused.

4.9.1 System Discharge Sequence

For a complete breakdown of the System Discharge Sequence, see [Section 5.4 on page 34](#).

Before Discharge Sequence

If the **Water Settings** are set to **Before Discharge**, the system will fill all front water before discharging any of the material scales.

During Discharge Sequence

If the **Water Settings** are set to **During Discharge**, the system will fill water as it also begins to discharge the material scales, depending on the delay timers configured for each scale.

Tail Water Sequence

Admixtures are either discharged with the front water or with the tail water depending on how they are configured in the **Admixture Settings**.

4.10 Manual Mode

Once Manual Mode is engaged, the system turns the background gray. While in Manual Mode, the operator can press the **Bin 1 – 3 Vibrator**, **Cement 1 Air** or **Cement 2 Air** and **Dust Collector 1** or **Dust Collector 2** buttons to toggle the respective outputs on and off. All other outputs are controlled by the switches on the front panel. No other options will be available until Manual Mode is disengaged.

- Turn the manual mode switch to the right to engage manual mode.
- Turn the manual mode switch to the left to disengage manual mode



NOTE: The system updates the actual weight as weight is dispensed (only if not running a batch). If running a batch, the actual weight dispensed is updated upon exiting Manual Mode.

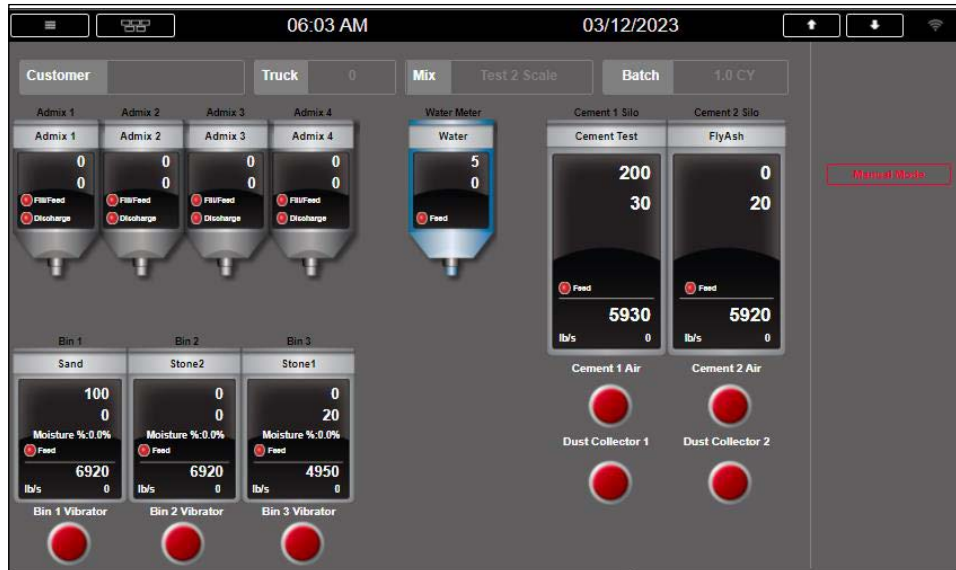

Figure 4-6. Manual Input Enabled



The system clears the values in each bin/admixture upon the start of the next batch.

4.11 Bin Vibrator/Cement Aeration

If the bin vibrator/cement aeration condition is set to **Always**, Bin X Vibrator/Cement X Air Output will be on the entire time Bin X Feed/Cement X Feed Output is on.

If the bin vibrator/cement aeration condition is set to **No Flow**, the system will check if the flow rate is LESS THAN the **Min Flow Rate for Bin X/Cement X**. If less than, the system will turn on **Bin X Vibrator/Cement X Air** Output for the remainder of the time **Bin X Feed/Cement X Feed** Output is on.

If the bin vibrator/cement aeration condition is set to **None**, nothing happens.

5.0 Appendix

5.1 Database Tables

5.1.1 Transactions (“Trans”) Database Table — 1,000 Records

Field	Type	Description
TickNum	Integer	Ticket Number
Customer	String	Customer Name
Truck	Integer	Truck Number
MixID	String	Unique mix ID (20-character max)
MixName	String	Mix Name (to be displayed when selecting a mix)
YM	String	Cubic Yards or Cubic Meters (CY-lb & CM-kg)
TYM	Real	Target Cubic Yards or Cubic Meters
Bin1T	Real	Target amount of Bin 1 in pounds or kilograms
Bin1A	Real	Actual amount of Bin 1 in pounds or kilograms
Bin2T	Real	Target amount of Bin 2 in pounds or kilograms
Bin2A	Real	Actual amount of Bin 2 in pounds or kilograms
Bin3T	Real	Target amount of Bin 3 in pounds or kilograms
Bin3A	Real	Actual amount of Bin 3 in pounds or kilograms
Cem1T	Real	Target amount of Cement 1 in pounds or kilograms
Cem1A	Real	Actual amount of Cement 1 in pounds or kilograms
Cem2T	Real	Target amount of Cement 2 in pounds or kilograms
Cem2A	Real	Actual amount of Cement 2 in pounds or kilograms
Admix1T	Real	Target amount of Admixture 1 in ounces or milliliters
Admix1A	Real	Actual amount of Admixture 1 in ounces or milliliters
Admix2T	Real	Target amount of Admixture 2 in ounces or milliliters
Admix2A	Real	Actual amount of Admixture 2 in ounces or milliliters
Admix3T	Real	Target amount of Admixture 3 in ounces or milliliters
Admix3A	Real	Actual amount of Admixture 3 in ounces or milliliters
Admix4T	Real	Target amount of Admixture 4 in ounces or milliliters
Admix4A	Real	Actual amount of Admixture 4 in ounces or milliliters
WaterT	Real	Target amount of Water in gallons or liters
WaterA	Real	Actual amount of Water in gallons or liters
DT	DateTime	Time and date of batch

Table 5-1. Transactions Database

5.1.2 Mix Design (“Mix”) Database Table — 1,000 Records

Field	Type	Description
ID	String	Unique mix ID (20 characters max)
Name	String	Mix Name (to be displayed when selecting a mix)
Bin1	Real	Bin 1 target (pounds/kilograms) weight-based on a 1-yard/meter batch
Bin2	Real	Bin 2 target (pounds/kilograms) weight-based on a 1-yard/meter batch
Bin3	Real	Bin 3 target (pounds/kilograms) weight-based on a 1-yard/meter batch
Cem1	Real	Cement 1 target (pounds/kilograms) weight-based on a 1-yard/meter batch
Cem2	Real	Cement 2 target (pounds/kilograms) weight based on a 1-yard/meter batch
Admix1	Real	Admixture 1 target (ounces/milliliters) based on a 1-yard/meter batch
Admix2	Real	Admixture 1 target (ounces/milliliters) based on a 1-yard/meter batch
Admix3	Real	Admixture 1 target (ounces/milliliters) based on a 1-yard/meter batch
Admix4	Real	Admixture 1 target (ounces/milliliters) based on a 1-yard/meter batch
Water	Real	Water target (gallons/liters) based on a 1-yard/meter batch

Table 5-2. Mix Design Database

5.1.3 Customers (“Customer”) Database Table — 500 Records

Field	Type	Description
ID	Integer	Customer ID
Name	String	Customer Name

Table 5-3. Customers Database

5.1.4 Language (“Language”) Database Table — 300 Records

Field	Type	Description
Nbr	Integer	Text string number
PriLan	String	Prompt in the primary language (English by default)
SecLan	String	Prompt in the secondary language (Spanish by default)

Table 5-4. Language Database

5.2 Hardware Setup

5.2.1 Serial Port Functions

Channel	Type	Description	Setup
1	CMD	Printer	9600,8,N,1
2	CMD	Currently Not Used	9600,8,N,1

Table 5-5. Serial Port

5.3 Serial Communications

5.3.1 Weigh Ticket

The program uses the Auxiliary Print Format #1 (Primary Language) and Auxiliary Format #2 (Secondary Language). To alter the ticket text, open Revolution or go into the configuration of the 1280. These tickets are not controlled by the language database.

System will blank any lines that are not being used.

Ticket #: 3			
Customer: Rice Lake Weighing			
Truck #: 1258			
Mix ID: 1			
Mix Name: Test			
Quantity: 1.0 CY			
Ingredient	Target	Actual	%TOL

Sand	95 lb	7930 lb	8247.4%
Stone2	196 lb	210 lb	7.1%
Stone1	291 lb	2810 lb	865.6%
Cement	100 lb	250 lb	150.0%
FlyAsh	200 lb	250 lb	25.0%
Admix 1	10 oz	11 oz	10.0%
Admix 2	5 oz	7 oz	40.0%
Admix 3	6 oz	6 oz	0.0%
Admix 4	7 oz	6 oz	-14.3%
Water	20 gal	20 gal	0.0%
04:08 AM 12/13/2021			

Figure 5-1. Weigh Ticket Print

5.4 System Discharge Sequence

Water settings allow for toggling between the system discharge settings. See [Section 3.4 on page 20](#) to view and edit the water settings.

5.4.1 Before Discharge Sequence

If the system is set to **Before Discharge** (Water Settings).

1. The system activates the **Water** output until the **Water Target - (Water Target * Tail Water Percentage)** is reached by sensing target pulses minus coast from the water meter. System keeps a portion of the water for Tail Water.
2. If the Admixes are set to begin with **Front Water** (Admixture Discharge), the system waits until the water starts flowing.
 - a. **Bottle**: activates the **Admix X Discharge** output until **Admix X Bottle Empty** input.
 - b. **Direct**: activates the **Admix X Fill/Feed** output until it senses enough of the target amount (pulses minus coast) from the admix meter on the **Admix X Pulse** input.
3. Once all front water is in:
 - a. The system tares the applicable scales.
 - b. The system delays for the **Bin/Cement X Delay Time**.
 - c. The system activates the **Bin/Cement X Feed** output for the scale until it reaches the **product target – free fall** weight. The scale will be displayed as a positive value.
4. Once all the **Bin/Cement** targets are reached:
 - a. **Dust Collector 1 and 2** outputs are deactivated.
 - b. The system displays “Conveyor Runout” for the **Conveyor Runout Time** and then deactivates the **Conveyor** output.

5.4.2 During Discharge Sequence

If the system is set to **During Discharge** (Water Settings).

1. The system tares the applicable scales.
2. The system activates the **Water** output until the **Water Target - (Water Target * Tail Water Percentage)** is reached by sensing target pulses minus coast from the water meter. System keeps a portion of the water for Tail Water. It senses pulses-coast from the water meter on the **Water Meter** input.
3. If Admixes are set to begin with front water, the system waits until the water starts flowing:
 - a. **Bottle**: activates the **Admix X Discharge** output until **Admix X Bottle Empty** input
 - b. **Direct**: activates the **Admix X Fill/Feed** output until it senses enough of the target amount (pulses minus coast) from the admix meter on the **Admix X Pulse** input
4. The system activates for the **Bin/Cement X Delay Time**.
5. The system activates the **Bin/Cement X Feed** output for the scale until it reaches the **product target – free fall** weight. The scale will be displayed as a positive value.
6. Once all the **Bin/Cement** targets are reached:
 - a. **Dust Collector 1 and 2** outputs are deactivated.
 - b. The system displays “Conveyor Runout” for the **Conveyor Runout Time** and then deactivates **Conveyor** output.

5.4.3 Tail Water Sequence

1. If Admix set to begin with tail water, the system waits until the water starts flowing:
 - a. **Bottle**: activates the **Admix X Discharge** output until **Admix X Bottle Empty** input
 - b. **Direct**: activates the **Admix X Fill/Feed** output until it senses enough **pulses-coast** from the admix meter on the **Admix X Pulse** input
2. System activates the **Water** output until **Water Target** is reached. It senses pulses from the **Water Meter** input.
3. System performs the following:
 - a. Adds a new record to the **Transaction Database** table. If **Transaction Database** ever becomes full, the oldest 25% are automatically deleted.
 - b. Prints a batch ticket if Auto Print is **Enabled**. If Auto Print is Disabled, the operator presses the **PRINT** button to print a ticket.

6.0 Specifications

Power

100 to 240 VAC; 50/60 Hz

Excitation Voltage

10 ± 0.5 VDC

16 x 350 ohm or 32 x 700 ohm load cells per A/D card

Analog Signal Input Range

-60 mV to 60 mV

Analog Signal Sensitivity

0.3 µV/graduation minimum at 7.5 to 120 Hz

1.0 µV/graduation recommended

A/D Sample Rate

7.5 to 960 Hz, software selectable

Resolution

Internal: 8,000,000 counts

Display: 1,000,000

System Linearity

± 0.01% full scale

Communication Ports

Port 1 & 2: Full duplex RS-232 with CTS/RTS, RS-422/485

Baud Rate: 1200 to 115200

Port 3: USB 2.0 Device (Micro)

USB Host: (2) Type A Connectors max 500 mA

Ethernet: Wired 10/100 Auto-MDX

Ethernet: Wireless 802.11 b/g/n 2.4GHz

On board

Selectable filters: Three stage, adaptive or damping

Embedded Linux® OS

8 GB eMMC (system use)

1 GB DDR3 RAM

460 MB onboard database (SQLite) storage

Up to 32 GB micro SD card

Display

Twelve-inch, 1280 × 800 pixel,

1,500 NIT

Temperature Range

Certified: 14 °F to 104 °F (-10 °C to 40 °C)

Operating: -4 °F to 131 °F (-20 °C to 55 °C)

Rating/Material

Painted mild steel enclosure

NEMA Type 4; IP66

Dimensions

20 × 20 × 8 in (508 x 508 x 203.2 mm)

Warranty

Two-year limited

EMC Immunity

EN 50082 Part 2 IEC

EN 61000-4-2, 3, 4, 5, 6, 8, 11



© Rice Lake Weighing Systems Content subject to change without notice.

230 W. Coleman St. • Rice Lake, WI 54868 • USA USA: 800-472-6703 • International: +1-715-234-9171