

# Application Guide for the Secura, Quintix and Practum Series

Getting Started Quickly

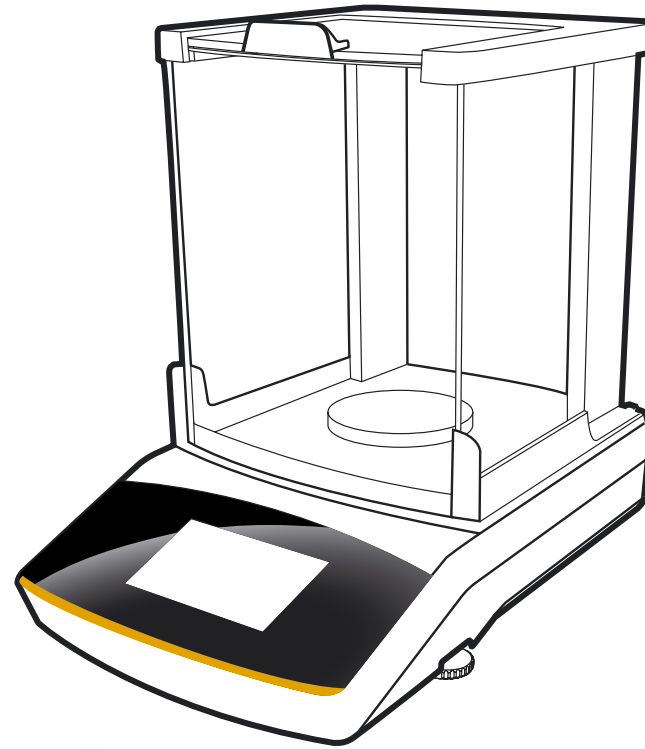
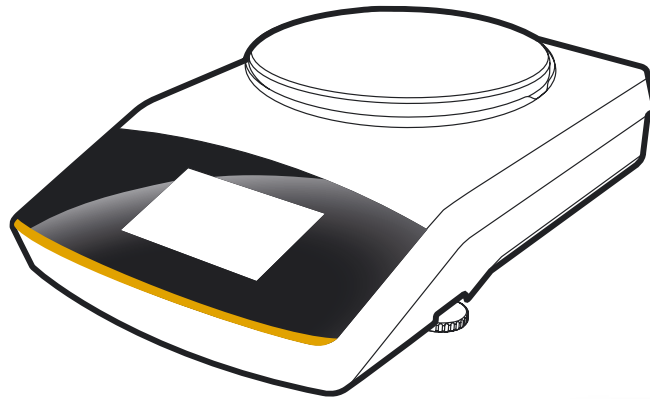

Density    Checkweighing    Counting    Statistics    Weighing    Components    Mixing    Percentage    Peak Hold    Conversion    Unstable Conditions

# The Touch Screen on Your Balance

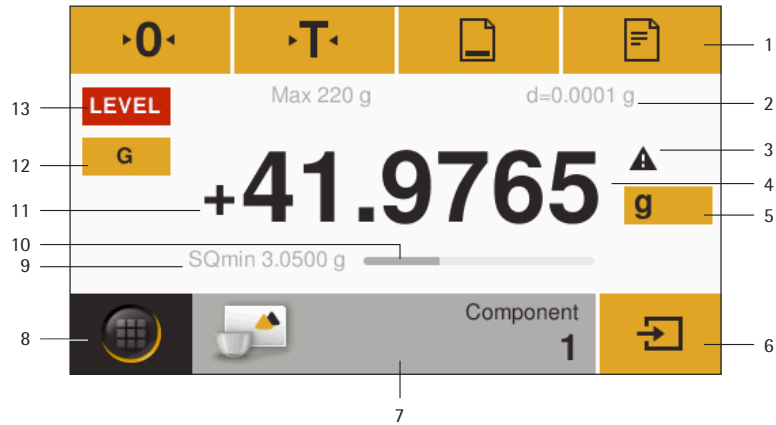

- 1 Toolbar showing currently available buttons: Zero, Tare, Print (data output), GLP Printout
- 2 Line for metrological specifications
- 3 Alert icon indicating calculated values
- 4 Current weight or value measured
- 5 Key for toggling between the weight unit and display accuracy
- 6 Key for running an application
- 7 Application toolbar: Settings for the selected application
- 8 Menu key: For toggling to the selection mode for applications and functions
- 9 Secura models only: USP minimum sample weight, SQmin
- 10 Bar graph: Scaled display showing capacity usage (in percent)
- 11 Plus (or minus) sign of the weight
- 12 Key for toggling between various display modes of a weight
- 13 Field for displaying the operating status and warnings

# Selecting the Language

Each balance has been factory preset to English. You can select your preferred language as follows:



Touch the menu key to enter the selection mode for applications and functions.



Touch the open-end wrench icon.



Select Language.



Touch the desired language and confirm selection by touching the checkmark.

# Leveling

To ensure accurate measurement results, you need to level the balance each time after you have moved it to a different location.

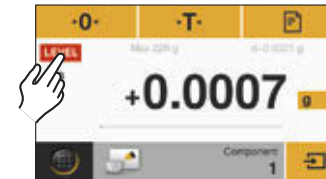

**Secura Balances**  
As soon as LEVEL appears on the display, you will need to level the balance. Make sure that the weighing pan is unloaded before you begin. Touch LEVEL. Then follow the prompts shown on the interactive display.

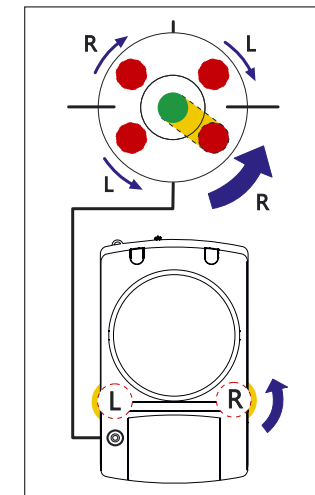
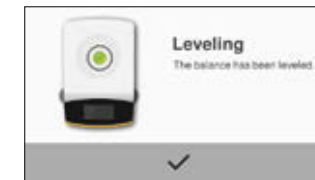

**Quintix and Practum Balances**  
Turn the two feet as shown in the picture until the air bubble is centered within the circle of the level indicator.

# Quick Access to Calibration and Adjustment

You will need to perform the combined calibration and adjustment procedure the first time you operate the balance, each time after changing it to a different location and at regular intervals during operation. If you are using a Practum series balance, you will have to do this manually as described below. The Secura and Quintix series perform this procedure fully automatically.

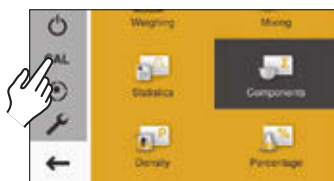

Touch CAL to select the combined calibration and adjustment mode.

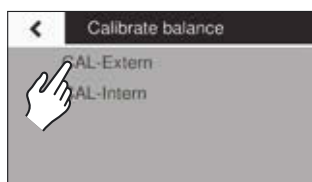

To perform external adjustment, touch CAL-Extern.

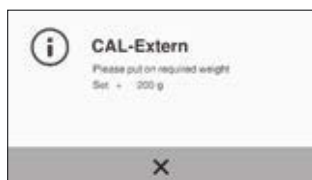

First touch **•0•**, then **START** to calibrate the balance. Place a calibration weight equal to that displayed on the balance on the pan. The balance will now perform automatic calibration and adjustment, then it will change to the operating mode.

# Getting Started Quickly

## Initial Operation of Balances with a Draft Shield

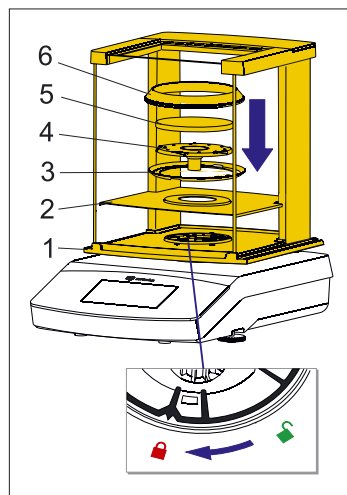

Secura Balances

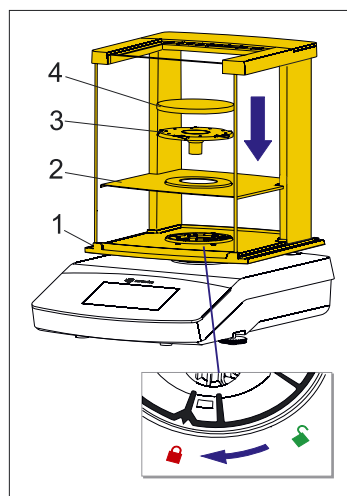

Quintix and Practum Balances

Install the following parts in the order listed:

- In-use dust cover
- Turn the draft shield lock to "unlocked"
- Place the draft shield (1) on the balance. Note: Use both hands to hold the top struts of the draft shield.
- Slide the side doors all the way to the back.
- Turn the draft shield lock to "locked"
- Position the base plate (2), centering ring\* (3), pan support (4), weighing pan (5) and high-rim shield ring\* (6) on the balance.

Note: For information about how to clean the draft shield, see the Care and Maintenance chapter in the Installation Instructions.

\* only for Secura with 0.1 mg readability

## Initial Operation of Balances Without a Draft Shield

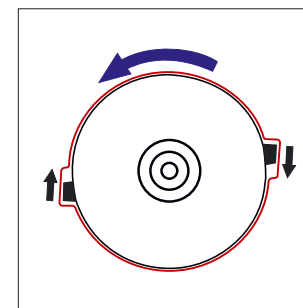

Install the following parts in the order listed:

- 1) In-use dust cover
- 2) Position the shield disk (1) and turn it clockwise until it is locked securely in place.

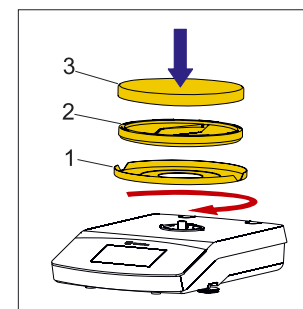

- 3) Position the pan support (2) and the weighing pan (3).

For detailed instructions, please refer to our Installation Instructions and our detailed User Manual.

# Quick Six-Step Guide to Applications



## Counting

Familiarize yourself with the capabilities of your Sartorius balance and start off by counting identical parts. The balance will show you the quantity and the total weight.



1

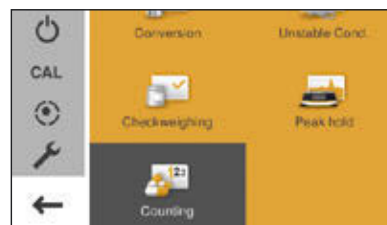

Touch the menu key to access the selection mode for applications and select "Counting".

2

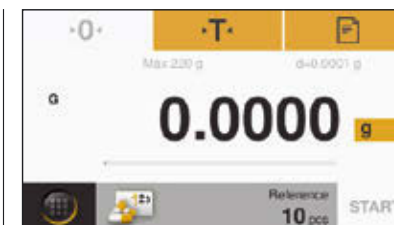

Place an empty container for your sample on the balance and press **·T·** to tare (zero the display).



## Mixing\*\*

Say you have a formula and need to weigh in various components quickly with 100% traceability, without losing track of the total weight. Just use the Mixing application.



1

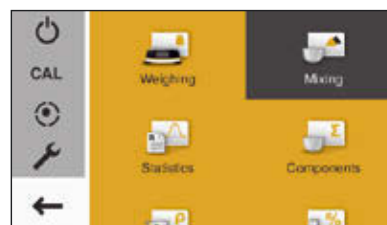

Touch the menu key to access the selection mode for applications and select "Mixing".

2

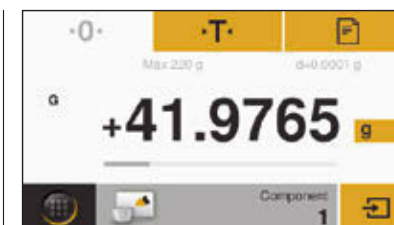

Place an empty container on the balance and press **·T·** to tare (zero) the container weight.



## Components\*\*

Do you need to compound components according to a formula, but don't want to mix them immediately? The application Components enables you to weigh your individual ingredients into different containers and retrieve the total amount weighed-in – anytime at the touch of a key.





1

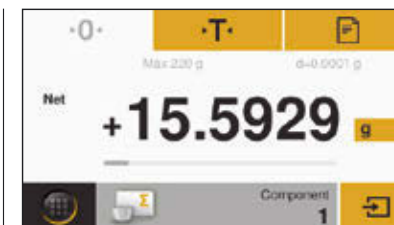

Touch the menu key to access the selection mode for applications and select "Components".

2



Place the first empty container on the balance and press **·T·** to tare (zero). Then weigh-in component 1 and touch  to save the weight in the memory.

\* To view videos of these applications, scan in our QR code or visit <http://www.sartorius.com/manual-secura>

\*\* Available in Quintix and Secura

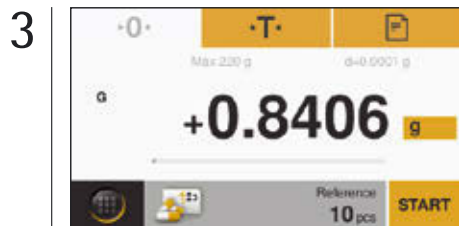

Enter the reference sample quantity by touching the **application toolbar** (factory setting: 10 pcs); place this quantity in the container and press **START**.

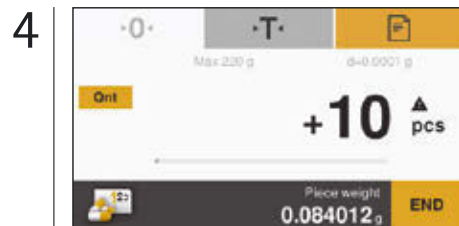

The reference sample quantity you entered will now appear on the display. Place your total sample quantity in the container.

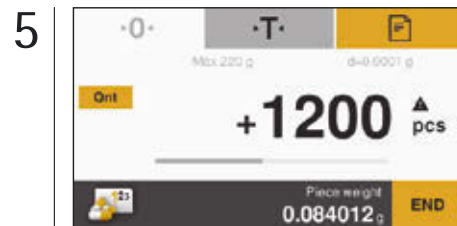

On the balance display, the piece count of your sample will now be shown. Touch **Ont** to view the total weight.

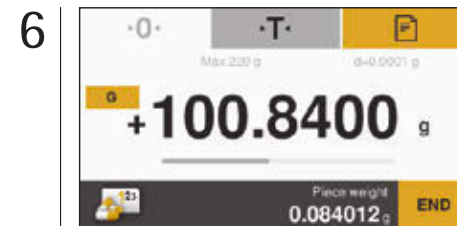

The total weight of your sample will now appear on the display.

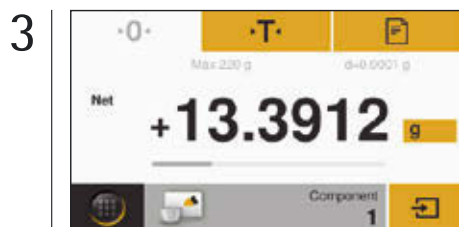

Add the first component to the container and touch  to save the component weight. The display will change to 0.

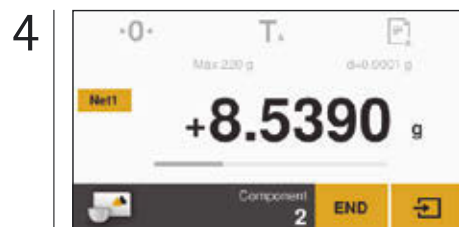

Add the next component and save its weight by touching .

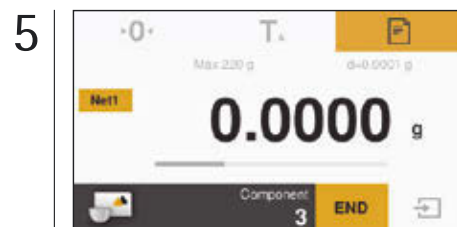

If necessary, you can add further components. Touch **Net1** to view the total weight.

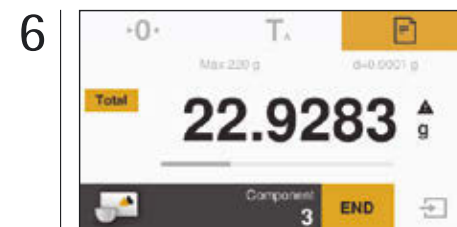

Now the total weight is displayed with a triangle (= calculated value). You can continue to add further components, if necessary.

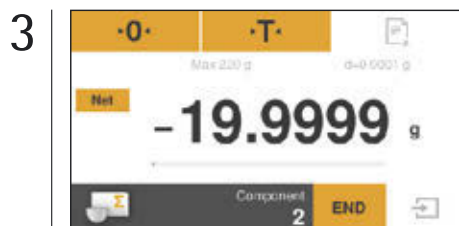

Remove the container with your first sample from the balance, the weight reading will change to a negative value.

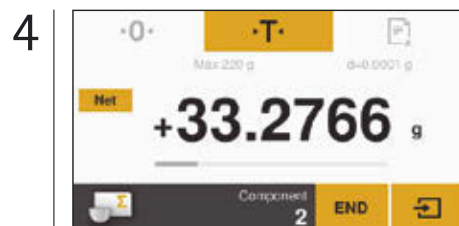

Now place another empty container on the balance and press **·T·** to tare (zero). Afterwards, you can add component 2 and confirm using .

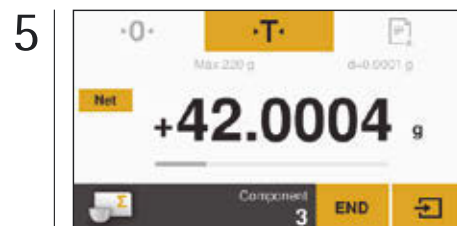

To weigh-in further samples, repeat this procedure. To display the total weight of the components added so far, touch **Net**.

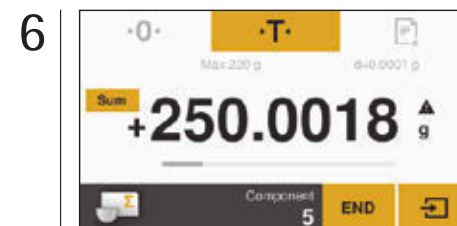

The total of all saved components will now be displayed ("Sum") with a triangle (= calculated value). Now you can remove the container with the last sample.





## Statistics\*\*

Would you like to save statistics on an entire group of different samples? Your Sartorius balance will transfer the readings to its statistics memory and generate a report on the key statistical parameters.



1

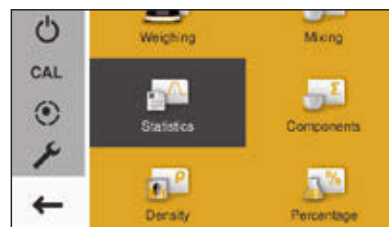

Touch the menu key to access the selection mode for applications and select "Statistics".

2

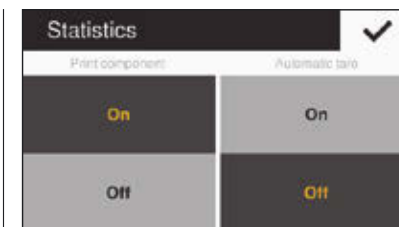

Touch **application toolbar** to select whether you want to have the result printed after each weighing operation and whether the balance is to be tared automatically after a value has been saved. Touch the checkmark to confirm.



## Density

Let's suppose you have a solid, irregularly-shaped object and want to precisely determine its density. Just use the Density application along with the Sartorius density determination kit to calculate the quality of, for example, precious metals and plastic parts with high accuracy.



1

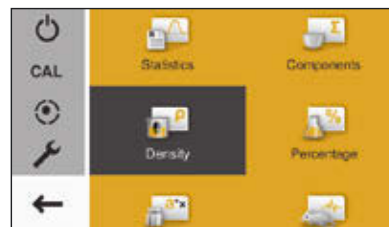

First install the density kit on your balance by following the instructions for the kit. Touch the menu key and select "Density".

2

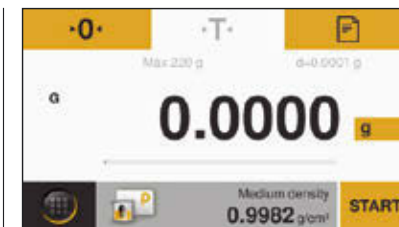

Tare (zero) your balance. Touch the **application toolbar** to set the density of the liquid ("Medium density") and the desired accuracy of the density result.



## Unstable Conditions

Do you have to weigh in an extremely unstable environment or measure the weight of an inquisitive little mouse that just won't sit still? No problem. This application lets you determine the weight reliably, giving you peace of mind about the accuracy and traceability of your results.



1

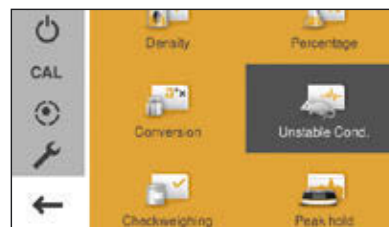

Touch the menu key to access the selection mode for applications and select "Unstable Cond." for unstable conditions or objects.

2

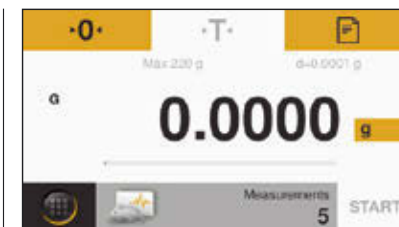

Touch the **application toolbar** to define the number of subweighing operations ("Measurements").

\* To view videos of these applications, scan in our QR code or visit <http://www.sartorius.com/manual-secura>

\*\* Available in Quintix and Secura

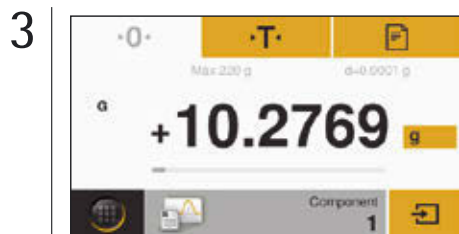

Touch **0.0** to zero the balance. Place your first sample on the balance and press **☑** to save the reading in the memory.

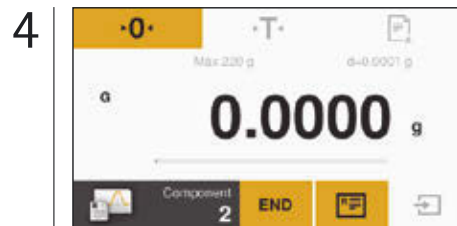

Remove the first sample from the balance. Now the display will change to 0.

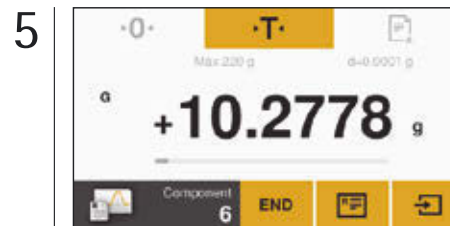

To weigh-in further samples, proceed in the same manner. Touch **☑** to display the results.

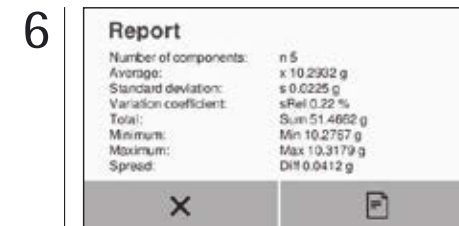

You will now see your results as a report.



Select the desired settings and confirm these by touching the checkmark. Then touch **START** on the next screen display.

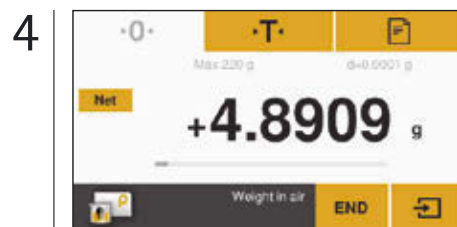

Place your sample on the upper pan of the density kit to view its weight in air and press **☑**.

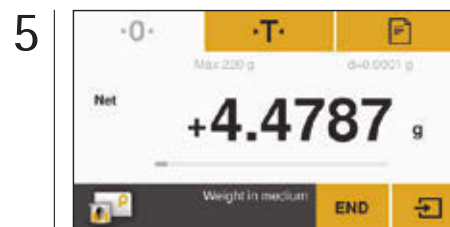

Immerse your sample in the sample holder in the beaker filled with your reference liquid; then touch **☑**.

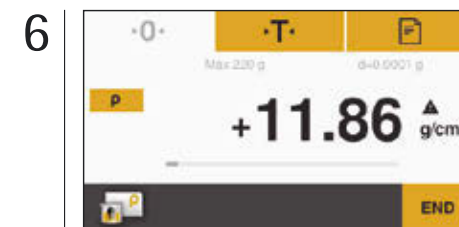

The balance will now show you the calculated density of your solid sample. The result will be displayed with a triangle (= calculated value).

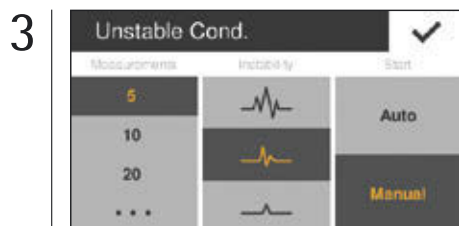

This number has been factory-set to five measurements. You can enter a different number by touching the three dots.



For example, press 1 and 5 to enter 15 measurements and touch the checkmark to confirm this number.

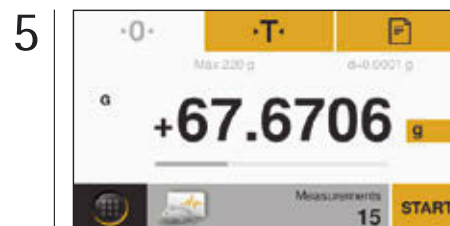

Place your sample or an animal on the pan and press **START** to begin weighing under unstable conditions.

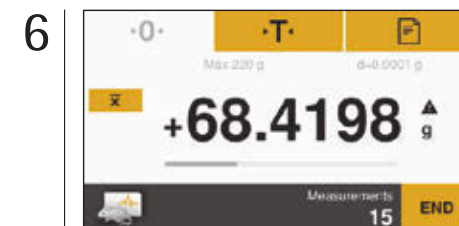

The averaged result will be displayed with a triangle (= calculated value).

Sartorius Weighing Technology GmbH  
Weender Landstrasse 94-108  
37075 Goettingen, Germany

Phone +49(0)551.308.0  
Fax +49(0)551.308.3289

[www.sartorius.com](http://www.sartorius.com)