

482-AG

Livestock Digital Weight Indicator
Version 1.00

Technical Manual



© Rice Lake Weighing Systems. All rights reserved.

Rice Lake Weighing Systems® is a registered trademark of
Rice Lake Weighing Systems.

All other brand or product names within this publication are trademarks or
registered trademarks of their respective companies.

All information contained within this publication is, to the best of our knowledge, complete and
accurate at the time of publication. Rice Lake Weighing Systems reserves the right to make
changes to the technology, features, specifications and design of the equipment without notice.

The most current version of this publication, software, firmware and all other product
updates can be found on our website:

www.ricelake.com

Revision History

This section tracks and describes manual revisions for awareness of major updates.

Revision	Date	Description
C	April 30, 2024	Established revision history; Updated print token information

Table i. Revision Letter History



Technical training seminars are available through Rice Lake Weighing Systems. Course descriptions and dates can be viewed at www.ricelake.com/training or obtained by calling 715-234-9171 and asking for the training department.

Contents

1.0	Introduction	7
1.1	Safety	7
1.2	Overview	8
1.3	Operating Modes	8
1.4	Front Panel Keypad	9
1.5	Keypad Functions	9
1.6	LCD Annunciators	10
1.7	Front Panel Navigation	11
1.7.1	Numeric Keypad - Editing Procedure for Numeric Values (482 Plus Only)	12
1.8	Indicator Operations	12
1.8.1	Zero Scale	12
1.8.2	Toggle Units	12
1.8.3	Print Ticket	12
1.8.4	Shrink Factor	12
1.8.5	Head Count	13
1.8.6	Load Total	13
2.0	Installation	14
2.1	Unpacking and Assembly	14
2.2	Enclosure Disassembly	14
2.3	Cable Connections	14
2.3.1	Cable Grounding	15
2.3.2	Wiring	16
2.4	Battery Operation	17
2.5	Configurable Back Light	17
2.6	Board Removal	18
2.7	Enclosure Reassembly	18
2.7.1	Seal the Indicator (Optional)	19
2.8	Replacement Parts	20
3.0	Configuration	23
3.1	Configuration Menu	24
3.1.1	Digital Filtering	25
3.1.2	Display Mode Parameters	27
3.1.3	Format Menu	28
3.2	Calibration Menu	29
3.3	Program Menu	30
3.3.1	Sleep Mode	31
3.4	Password Menu	32
3.5	Test Menu	32
3.6	Menu Parameters	33
3.6.1	Audit Trail Support	33
3.6.2	Serial Menu	34
3.6.3	Continuous Data (Stream) Output Formats	37
3.6.4	Print Format Menu	40
3.6.5	Version Menu	41
3.6.6	MISC Menu	41



Rice Lake continually offers web-based video training on a growing selection of product-related topics at no cost. Visit www.ricelake.com/webinars

4.0 Calibration	42
4.1 Front Panel Calibration	42
4.2 EDP Command Calibration	43
4.3 Adjusting Final Calibration	43
5.0 Animal Weighing Operation	44
5.1 Group Mode Operation	44
5.1.1 Group Settings	44
5.1.2 Weighing Groups in Group Mode	44
5.2 Live Mode Operation	45
5.3 Hold Mode Operation	45
5.3.1 Hold Settings	45
5.3.2 Weighing Groups in Hold Mode	46
6.0 EDP Commands	47
6.1 The EDP Command Set	47
6.1.1 Key Press Commands	47
6.1.2 Reporting Commands	48
6.1.3 Special Function Commands	48
6.1.4 Parameter Setting Commands	48
6.1.5 Weigh Mode Commands	51
7.0 Print Formatting	52
7.1 Print Formatting Tokens	52
7.1.1 Print Defaults	53
7.2 Customizing Print Formats	53
8.0 Maintenance and Troubleshooting	54
8.1 Error Messages	54
8.1.1 Displayed Error Messages	54
8.1.2 Using the XE EDP Command	55
8.2 ASCII Character Chart	56
8.3 Front Panel Display Characters	58
9.0 Specifications	59



Technical training seminars are available through Rice Lake Weighing Systems. Course descriptions and dates can be viewed at www.ricelake.com/training or obtained by calling 715-234-9171 and asking for the training department.



Rice Lake continually offers web-based video training on a growing selection of product-related topics at no cost. Visit www.ricelake.com/webinars

1.0 Introduction

This manual is intended for use by service technicians responsible for installing and servicing 482-AG digital weight indicators.



Manuals are available from Rice Lake Weighing Systems at www.ricelake.com/manuals

Warranty information is available at www.ricelake.com/warranties

1.1 Safety

Safety Definitions:



DANGER: Indicates an imminently hazardous situation that, if not avoided, will result in death or serious injury. Includes hazards that are exposed when guards are removed.



WARNING: Indicates a potentially hazardous situation that, if not avoided, could result in serious injury or death. Includes hazards that are exposed when guards are removed.



CAUTION: Indicates a potentially hazardous situation that, if not avoided, could result in minor or moderate injury.



IMPORTANT: Indicates information about procedures that, if not observed, could result in damage to equipment or corruption to and loss of data.

General Safety

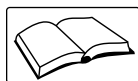

Do not operate or work on this equipment unless this manual has been read and all instructions are understood. Failure to follow the instructions or heed the warnings could result in injury or death. Contact any Rice Lake Weighing Systems dealer for replacement manuals.



WARNING

Failure to heed could result in serious injury or death.

Some procedures described in this manual require work inside the indicator enclosure. These procedures are to be performed by qualified service personnel only.

Do not allow minors (children) or inexperienced persons to operate this unit.

Do not operate without the enclosure completely assembled.

Do not use for purposes other than weight taking.

Do not place fingers into slots or possible pinch points.

Do not use this product if any of the components are cracked.

Do not exceed the rated specification of the unit, see [Section 9.0 on page 59](#).

Do not make alterations or modifications to the unit.

Do not remove or obscure warning labels.

Do not submerge.

Before opening the unit, ensure the power cord is disconnected from the outlet.

1.2 Overview

The 482-AG is a single-channel digital weight indicator housed in a NEMA 4X/IP66-rated stainless steel enclosure. The indicator front panel consists of a large (.8 in, 20 mm), six-digit, seven-segment, backlight LCD display and an 18-key full numeric keypad.

Features

- Auto switching AC power supply 115 VAC to 230 VAC, 50-60 Hz
- Drives up to ten 350 Ω or twenty 700 Ω load cells
- Supports four and six wire load cell connections
- Two communications ports with Demand or Continuous (COM 2 only) outputs
- Unit ID of up to six operator entered numeric digits
- Configurable LCD backlight

Supported Application

Custom Ticket Printing: Format may be customized up to 300 characters, Time and Date, Unit ID, and Consecutive Ticket Number printing.

1.3 Operating Modes

The 482-AG has four modes of operation.

Weigh Mode

Weigh mode is the default mode of the indicator. The indicator displays gross weight, a transaction in process annunciator, the universal standstill symbol and center of zero symbol, when conditions are met, to indicate scale status ([Section 1.6 on page 10](#)).

Configuration Mode

Most of the procedures described in this manual, including calibration, require the indicator to be in configuration mode.

To enter the configuration mode:

1. Remove the configuration switch access screw from the back of the enclosure. See [Figure 2-1 on page 14](#).
2. Insert a non-conductive tool into the access hole and press the configuration switch. The indicator display changes to **CONFIG** mode.

Test Mode

Test mode provides a number of diagnostic functions for the 482-AG indicator including:

- Display raw A/D count
- Number of weighments over threshold
- Reset configuration parameters to default values

See [Section 3.5 on page 32](#) for more information on the test menu structure and the test menu functions.

Sleep Mode

Firmware version 1.03 and newer of the 482-AG features a sleep mode. This feature is designed to place the indicator into a low power mode to reduce power consumption.

The sleep mode will activate only if the indicator is operating on the optional internal battery. If the indicator is connected to an external AC power source, it will not go into sleep mode regardless of the parameter settings.

The indicator will enter the sleep mode, after a specified time when no keypad activity is detected and the displayed weight is below the weight threshold. Setting the sleep parameter to **NEVER** disables the sleep mode. A **Standby** parameter determines how often the indicator will briefly wake, while in the sleep mode, to check for activity thresholds. See [Section 3.3.1 on page 31](#) and [Table 3-7 on page 30](#) for information on configuring sleepmode and standby parameters

1.4 Front Panel Keypad

See [Section 1.7 on page 11](#) for information about using the front panel keys in configuration mode.

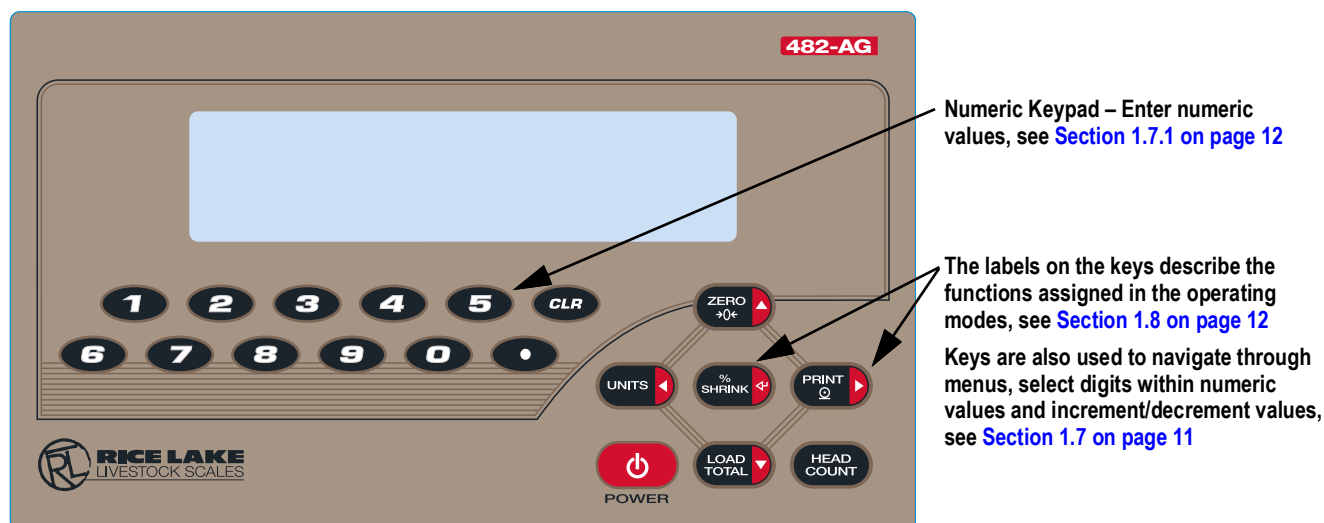

Figure 1-1. 482-AG Front Panel Key Functions

1.5 Keypad Functions

Key	Function
	Powers the unit on/off NOTE: If power mode is set to manual, the Power key must be used to turn the unit on and off. If power mode is set to auto, the unit will automatically power on when it's plugged in and the only way to turn it off is to unplug power, see Section 3.6.6 on page 41.
	Applies the entered head count value see Section 1.8.5 on page 13
	Sets the current gross weight to zero, provided the amount of weight to be removed or added is within the specified zero range and the scale is not in motion; the zero band is defaulted to 2% of full scale, but can be configured for up to 100% of full scale; see Section 1.8.1 on page 12 Also used as a move up key to navigate to different menu levels or used to increment a number when editing a value
	Switches the weight display to an alternate unit; the alternate unit is defined in the Configuration menu and could be kg, g, lb, oz, tn, or t; Also used as a scroll left key to navigate to different menus or to toggle to another digit when editing a value
	Sends an on-demand print format out the serial port, provided the conditions for standstill are met; PRINT may be displayed while printing; see Section 1.8.3 on page 12 Also used as a scroll right key to navigate to different menus or to toggle to another digit when editing a value
	Applies the input shrinkage value when weighing animals; see Section 1.8.4 on page 12 Also used as enter to select parameter settings or confirm values
	Sums the total animal weight previously weighed and the live weight on the scale as adding animals; see Section 1.8.6 on page 13 Also used as down arrow, to navigate through menus; decrements a number when editing a value
	Used during a numeric entry and sets the currently select digit to 0 and then advances one digit to the right; when the indicator is in the hold mode; can be used to release a held weight and return to live weighing

Table 1-1. Keypad Functions

1.6 LCD Annunciators

The 482-AG LCD display uses annunciators to provide additional information about the value being displayed.

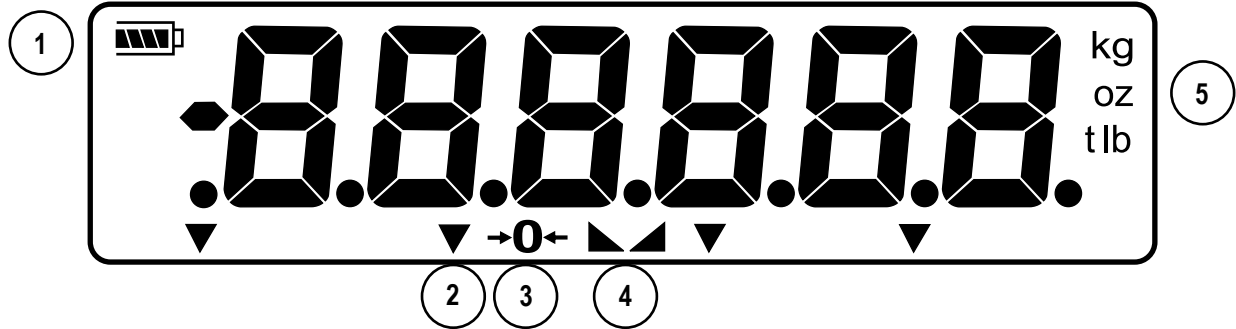

Figure 1-2. LCD Annunciators

Item No.	Description	Function
1	Battery Level	The battery icon indicates the level of the battery
2	Transaction in Process	Signifies that the indicator is in the middle of collecting data from groups making up the load NOTE: When loading and unloading groups, the power standby mode may engage and power down the indicator. Once the indicator is powered back on, this annunciator signifies that the indicator is still in the middle of collecting load data. The previous group data totals are saved in case of a power down in the middle of collecting load groups
3	Zero (Center of Zero)	Indicates that the current weight reading is within ± 0.25 display divisions of the acquired zero, or is within the center of zero band
4	Standstill	Indicates that the scale is at standstill, or within the specified motion band; Standstill is required for some operations, including zero, tare and printing
5	lb / kg / g / oz / t	Displays which unit of measure is being used: <ul style="list-style-type: none"> • lb = pounds • kg = kilograms • g = grams • oz = ounces • t = for either short tons and metric tons NOTE: See Section 3.1.3 on page 28 for more information about configuring primary and secondary display units.

Table 1-2. LCD Annunciators

1.7 Front Panel Navigation

Four front panel keys are used as directional keys to navigate through the menus.

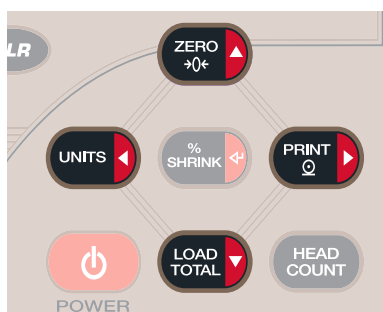
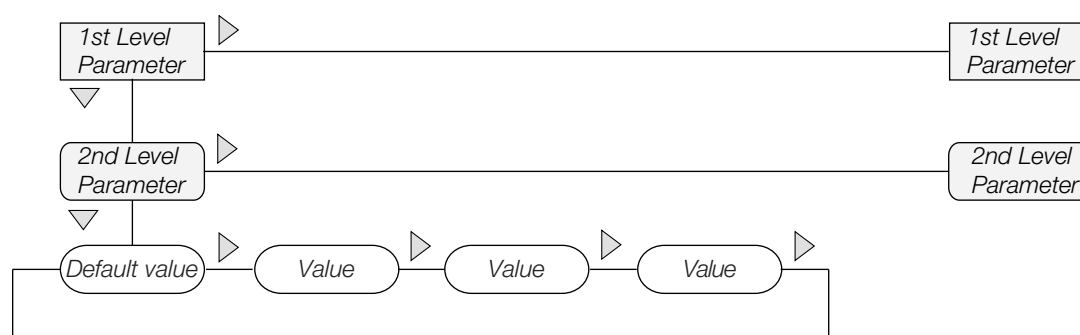

Figure 1-3. Front Panel Navigation Keys

Navigating Through Levels



When moving through values below the first menu level, press \blacktriangle to return to the level above.
Press \odot or \blacktriangledown to move to the next parameter on the level below.

Figure 1-4. Menu Navigation

To select a parameter, press \blacktriangleleft or \blacktriangleright to scroll left or right until the desired menu group displays then press \blacktriangledown to move down to the desired sub-menu or parameter. When moving through the menu parameters, the present value displays.

Edit Parameter Values

To change a parameter value, scroll left or right to view the values for that parameter. When the desired value displays, press **Tare** \blacktriangleleft to select the value and move back up one level. To edit numerical values, use the navigation keys to select the digit and to increment or decrement the value.

0 0 0 0 0 0

When editing numeric values, press \blacktriangleleft or \blacktriangleright to change the digit selected. Press \blacktriangle or \blacktriangledown to increment or decrement the value of the selected digit. Press \blacktriangleleft to save the value entered and return to the level above.

Figure 1-5. Editing Procedure for Numeric Values

1.7.1 Numeric Keypad - Editing Procedure for Numeric Values (482 Plus Only)

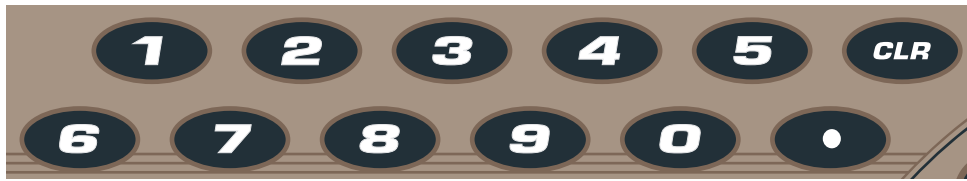





Figure 1-6. Numeric Keypad for the 482-AG



NOTE: With the numeric keypad, numbers can be edited using the keypad in addition to the arrow method.

1. When editing numeric values, insert the required value using the numeric keypad.
 - i. Press  to set the currently selected digit to 0
 - ii. Press  to enter a decimal point
2. Press  to save the value entered and return to the level above.





NOTE: When editing fractional numeric values, the decimal point must be positioned in accordance with the primary units formatting, otherwise the keyed number may be rejected by the software.

1.8 Indicator Operations

Basic operations for the 482-AG are summarized below.

1.8.1 Zero Scale

1. Remove all weight from the scale and wait for the  annunciator to light.
2. Press . The  annunciator lights to indicate the scale is zeroed.

1.8.2 Toggle Units



Press  to toggle between primary and secondary units. The current unit annunciator is displayed.





NOTE: Units cannot be changed once a group weighment has been started.

1.8.3 Print Ticket

The print key sends the group data to the serial port. This key will also reprint a group ticket for the current group data on the indicator. For more information on print formatting, see [Section 7.0 on page 52](#).

1. Wait for  annunciator to display.
2. Press  to send data to the serial port.



NOTE: If the  key is pressed when the  is not displayed, unless the scale stabilizes within three seconds, the print command is ignored.

1.8.4 Shrink Factor



The shrink factor limits are 0.0% to 99.0%. The default is 0.0%. In the weigh mode, enter the shrink factor on the numeric

keypad and press . The entered shrink factor is applied to every weighment until the shrink factor is changed or the

indicator is reset. A shrink factor, however, can be entered at any time, but only the last shrink factor prior to pressing  will be applied to all of the groups making up the load. The shrink factor is not displayed when weighing, however, the shrink factor value and results are printed on the load total ticket only. The entered shrink factor is stored and will survive power cycles.

1.8.5 Head Count

The head count limits are 1 to 99. If the value entered contains a decimal point, only the numbers to the left of the decimal point will be used. In the weigh mode,



1. Wait for  annunciator to display.
2. Enter the head count on the numeric keypad and press .
3. Using the numeric key pad, enter the number of animals currently on the scale, then press .

The head count will not be displayed when weighing, however, the results will be on the printed ticket.

If the display mode is not set to hold, immediately after the head count is entered, the group data is sent to the serial port.

If the display mode is set to hold, -SPL- is displayed as the scale is sampled for the set sampling time duration (**SPTIME**). When the sample time is complete, the average weight of the samples collected is displayed and the current weight units annunciator flashes indicating the display is being held. Press  to send the group data to the serial port.

1.8.6 Load Total

The load total is the accumulated data of all groups in the load. When weighing groups, the group number on the printed ticket increments with each group. Pressing  when done with all load groups gives a summary data for all the groups and includes: total number of groups, total weight of all groups, total head count, shrink factor, if entered, total group weight with shrink factor and the total group average weight per animal, see [Figure 5-1 on page 45](#) for a sample print of group and load totals. Pressing  resets the group number and a new load can be started.



NOTE: *There is no reprint ability for the Load Total data.*

2.0 Installation

2.1 Unpacking and Assembly

Immediately after unpacking, visually inspect the 482-AG to ensure all components are included and undamaged. The shipping carton should contain the indicator and a parts kit. If parts were damaged in shipment, notify Rice Lake Weighing Systems and the shipper immediately, see [Section 2.8 on page 20](#) for the parts kit contents.

2.2 Enclosure Disassembly

The indicator enclosure must be opened to connect the scale load cell cable and any other interface connections.



WARNING: Before opening the unit, ensure the power cord is disconnected from the power outlet.

1. Ensure power to the indicator is disconnected.
2. Place the indicator face-down on an anti-static work mat.
3. Remove the screws that hold the backplate to the enclosure body.
4. Lift the backplate away from the enclosure and turn it over to access boards.



IMPORTANT: The display cable will still be attached. Be careful when lifting and turning over the backplate to prevent the backplate from potential damaged.

2.3 Cable Connections

The 482-AG provides four cord grips for cabling into the indicator: one is for the power cord and three are to accommodate the load cell cable and communications cables. Two of the three free cord grips come with a plug installed to prevent moisture from entering the enclosure. Depending on the application, remove the plug from another cord grip that will be used and install cables as required, see [Figure 2-1](#) for the recommended assignments for the 482 cord grips.

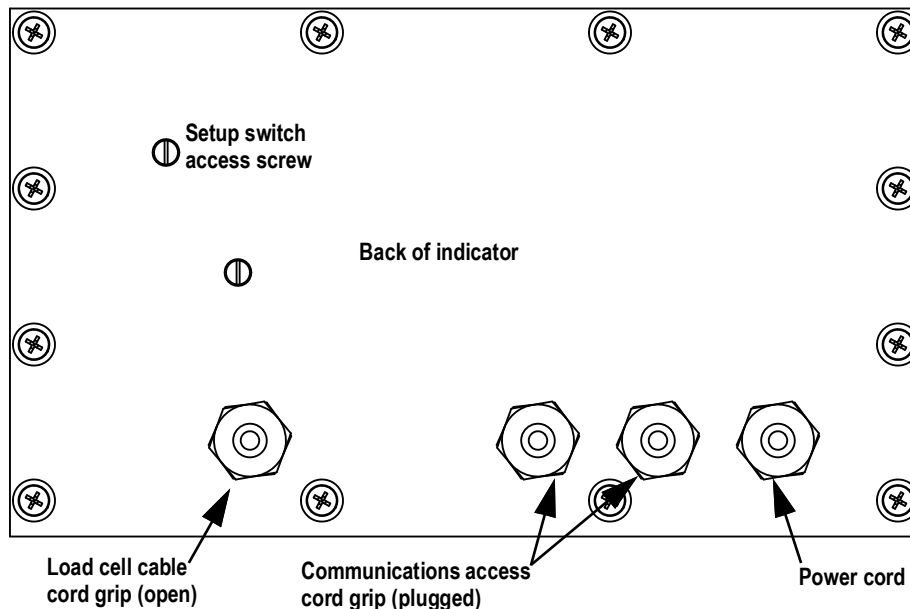

Figure 2-1. Recommended Cord Grip Assignments



IMPORTANT: When installing cords through cord grips, ensure the cord grip is tightened snugly to prevent moisture from entering the enclosure.

2.3.1 Cable Grounding

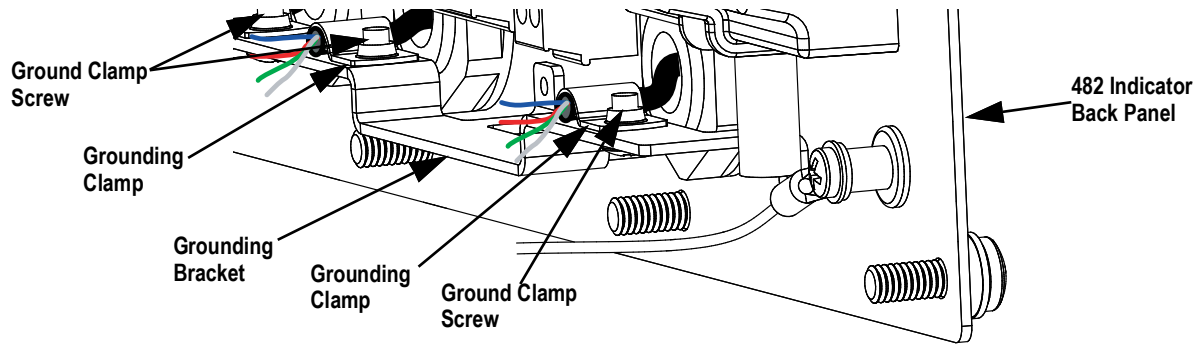

Figure 2-2. Grounding Clamp Attachment

Except for the power cord, all cables routed through the cord grips should be grounded against the indicator enclosure.

1. Install the ground clamps on the grounding bar, use the ground clamp screws. Do not tighten the screws at this time.
2. Route the cables through the cord grips and the grounding clamps to determine the cable lengths required to reach the cable connectors.
3. Mark the cables to remove insulation and shield, see **Stripping Cables** below.
4. Route stripped cables through the cord grips and grounding clamps.
5. Ensure the shields contact the grounding clamps and tighten the ground clamp screws.

Stripping Cables

To strip and ground foil insulated cable:

1. Strip the insulation and foil from the cable 1/2 in (15 mm) past the grounding clamp.
2. Fold the foil shield back on the cable where the cable passes through the clamp.
3. Ensure the silver (conductive) side of the foil is turned outward for contact with the grounding clamp.

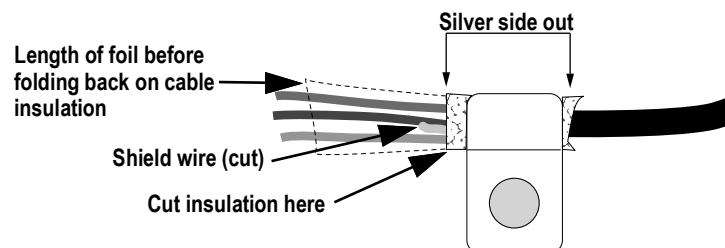

Figure 2-3. Foil Insulated Cable

To strip and ground braided shielding:

1. Strip the insulation and braided shield from a point just past the grounding clamp.
2. Strip another 1/2 in (15 mm) of the insulation to expose the braid where the cable passes through the clamp.

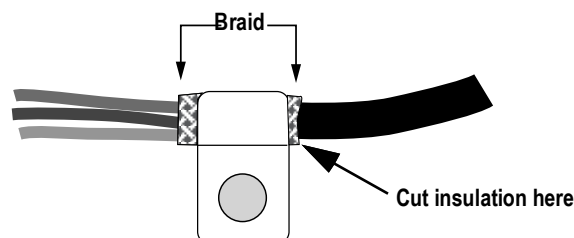

Figure 2-4. Braided Insulated Cable

To strip and ground load cell cables:

Cut the shield wire just past the grounding clamp. Shield wire function is provided by contact between the cable shield and the grounding clamp.

2.3.2 Wiring

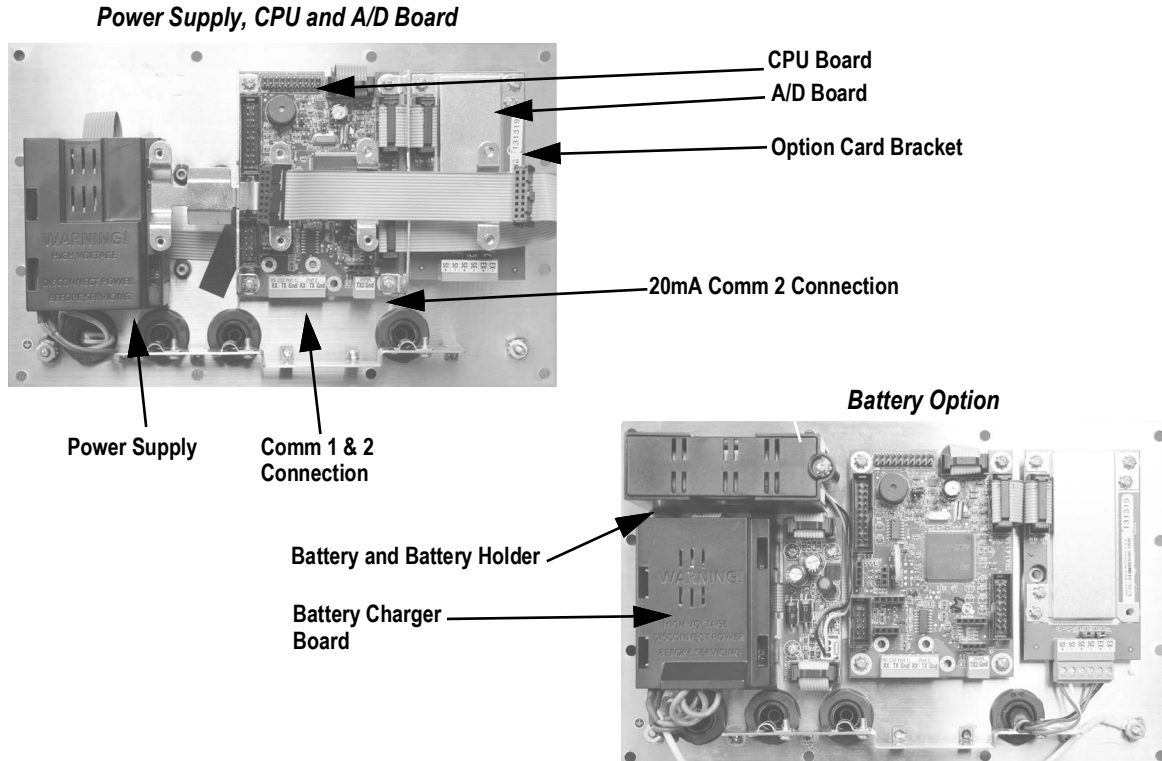

Figure 2-5. 482-AG Board Options

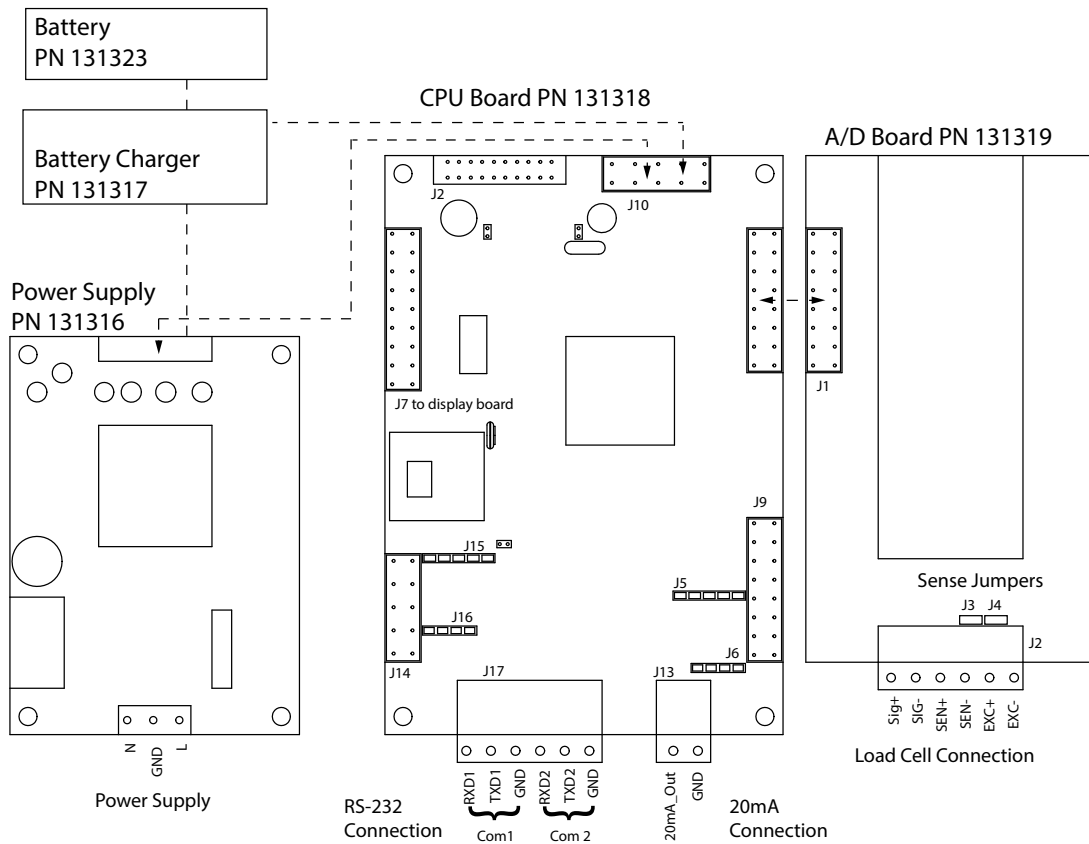

Figure 2-6. Wiring Diagram

2.4 Battery Operation

The 482-AG can be equipped with an optional internal Lithium-Ion battery to provide up to:

- 40 hours of continuous use (single load cell, 350 ohms, no LCD backlight)
- 15 hours of continuous use (single load cell, 350 ohms, with LCD backlight)

When operated on AC power, the internal battery is automatically charged.

The status of the battery is displayed by an icon in the upper left corner of the LCD display. When operating on battery power, the icon of the approximate percentage of battery life remaining displays. When connected to AC power, the icon indicates if the battery is charging or fully charged. The following table outlines the meaning of the various battery icon indication levels.







Battery Percent	Battery Indicator Level
100% > bat > 75%	4 - Levels 
75% > bat > 50%	3 - Levels 
50% > bat > 25%	2 - Levels 
25% > bat > 10%	1 - Level 
10% > bat > 5%	0 - Levels 
5% > bat > 0%	Blinking 
0%	Indicator is turned off
Charging	Animated 

Table 2-1. Battery Indication Levels

Battery life depends on several factors, including number of load cells, frequency of use, LCD backlight, options installed, temperature, and other accessories being used. Battery charge time is approximately 16 hours to 100%.

To extend battery life, the indicator features a sleep mode that allows the indicator to go into a low power mode while it's operating on battery power, see [Section 3.3.1 on page 31](#) for more information about the sleep mode.

When the battery life reaches 5-10 percent of capacity, the **Lo Bat** flashes on the display. When the battery life is less than 5%, it will flash faster. At 0% the indicator will turn off. Battery charge time is approximately 16 hours to 100%.

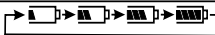
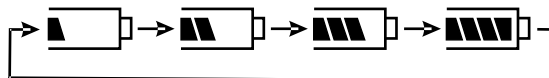

Figure 2-7. Battery Charging Cycle Example



NOTE: When installing a 482-AG with a battery option, it is recommended that the CPU board jumper 4 on the A/D Board be removed. See [Figure 2-6 on page 16](#). Removing jumper 4 will maximize the life of the battery when the indicator is turned off due to reduced standby current, see the **POWER** parameter in [Section 3.6.6 on page 41](#) for more information.

2.5 Configurable Back Light

The 482-AG includes a configurable LCD backlight for viewing the display in low-light situations. The backlight can be configured to be **On**, **Off** or in **Auto Mode**. Configure the backlight using the **BKLGHT** parameter, see [Section 3.6.6 on page 41](#). When using battery power, use the off or automatic setting to reserve power.

The backlight consumes considerable power. When the automatic setting is selected, the backlight will go out after a set time of inactivity. Pressing a key or any motion on the scale will activate the backlight.

The backlight is configured using the BKLGHT menu function. To set **Auto Mode**, select one of the fixed time settings between 10 seconds and 10 minutes. The backlight will turn off when there has been no change of motion or key presses during the selected time. The backlight will turn back on automatically once there is a change in motion or a key pressed.

2.6 Board Removal

To remove the 482-AG board, use the following procedure:

1. Disconnect power to the indicator.
2. Remove backplate as described in [Section 2.2 on page 14](#).
3. Disconnect all cables from the board.
4. Label connections for re-installation of board.
5. Remove the four screws from the board then lift the board off the backplate.

To install a board, reverse the above procedure. Be sure to reinstall cable ties to secure all cables inside indicator enclosure.



NOTE: When removing lower boards, the upper boards and option bracket, if installed, will need to be removed first.

2.7 Enclosure Reassembly

Once cabling is complete, position the backplate over the enclosure and reinstall the backplate screws. Use the torque pattern in [Figure 2-8](#) to prevent distorting the backplate gasket. Torque screws to 10 in-lb (1 N-m).

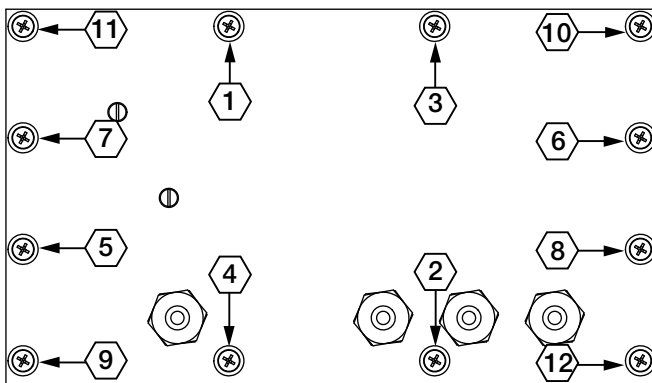

Step 1.
Torque 1-4 in the order shown

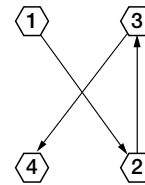

Step 2.
Torque 5-8 in the order shown

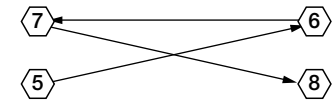

Step 3.
Torque 9-12 in the order shown

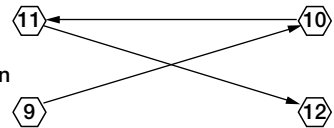

Figure 2-8. 482 Enclosure Backplate

Torque	in-lb	Nm
Backplate screws	10	1
Cable Glands	22	2.5
Cable Gland Caps	13.3	1.5
Vent	5-7	0.6-0.8

Table 2-2. Torque Values



NOTE: Torqued screws may become less tight as the gasket is compressed during the torque pattern; a second torque is required using the same pattern and torque value.

2.7.1 Seal the Indicator (Optional)



NOTE: For access to configuration parameters, the setup switch must be pressed.

Prevents Service Access

Insert a lead wire seal through three fillister screws. This prevents access to the electronics, electrical contacts and Legal for Trade configuration parameters.

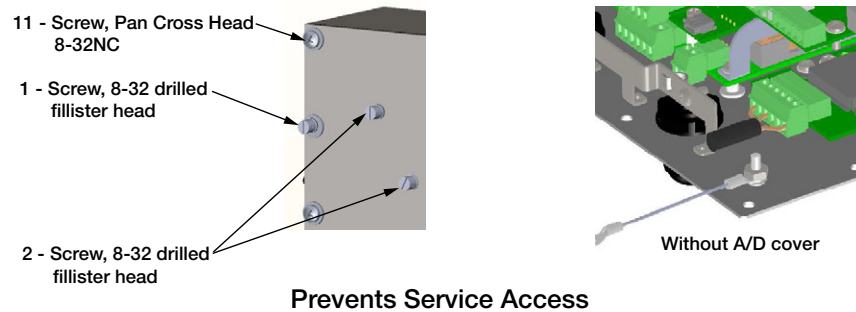

Figure 2-9. Sealing the Indicator to Prevent Access



IMPORTANT: Only use the 1/4 in screw in the top hole for sealing, using the longer one will damage the CPU board.

Allows Service Access – Optional

The calibration cover is used for inserting a lead wire seal through both fillister screws and the plastic cover. The cover allows access to the electronics and electrical contacts, while preventing access into Legal for Trade configuration parameters.

There is an alternative cover over the A/D to ensure the A/D and load cell connection cannot be changed after the unit is sealed.

There is also an audit trail counter to track calibration and configuration changes made to legally relevant parameters.

Place the calibration cover on the backplate and secure with the existing fillister head screws and o-rings to seal the indicator for Legal for Trade approval.

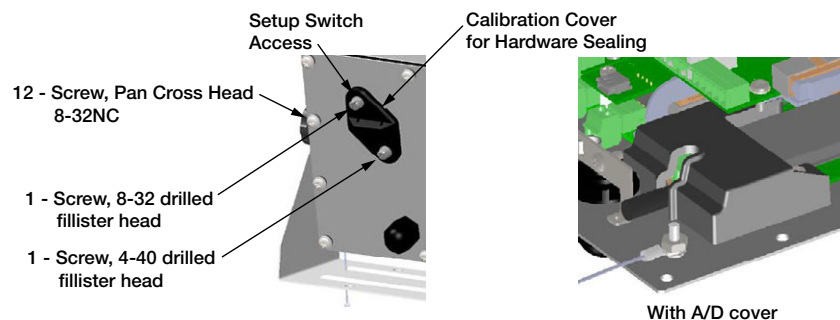

Figure 2-10. Sealing the Indicator to Allow Access Option

2.8 Replacement Parts

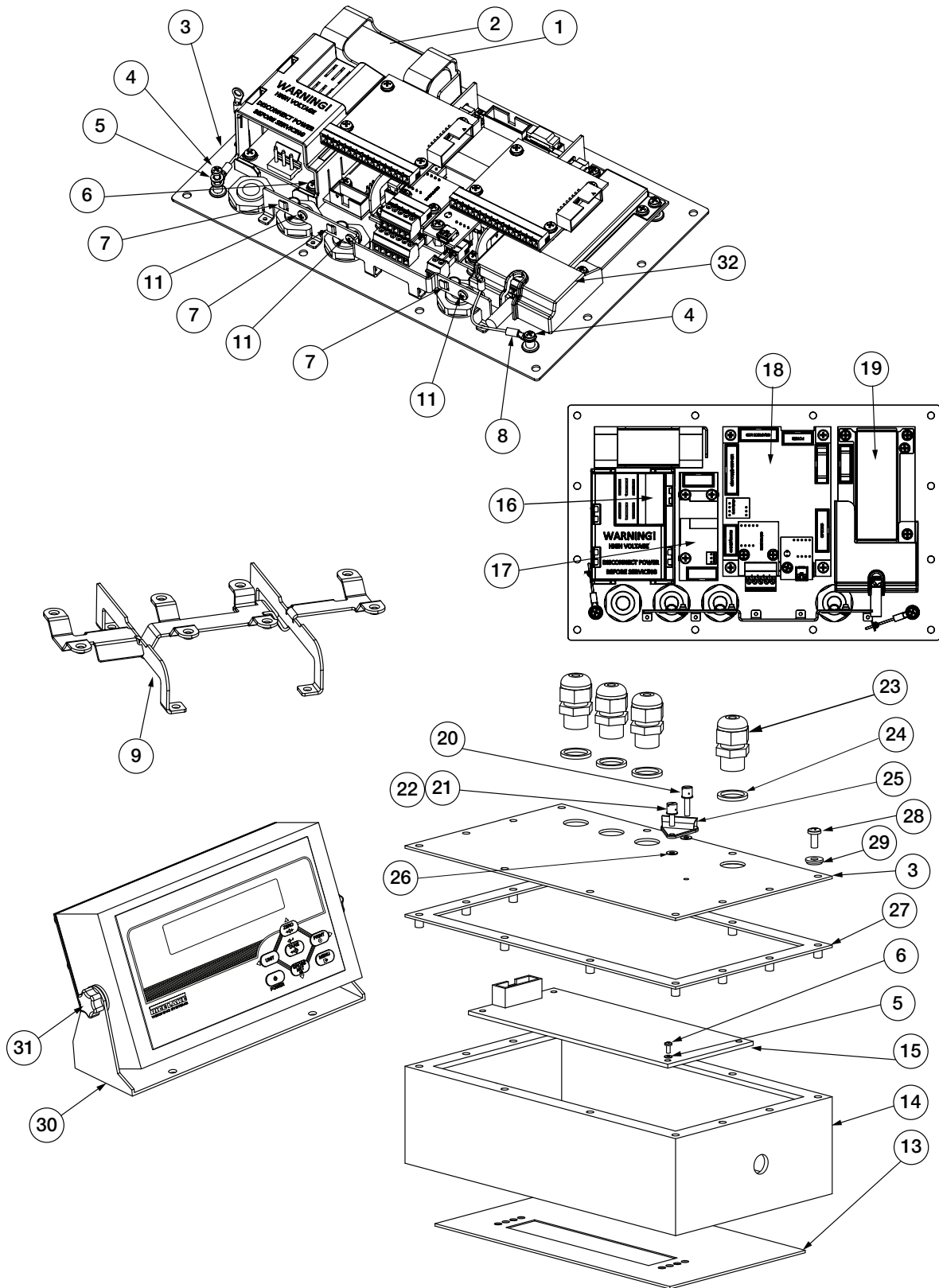

Figure 2-11. Replacement Parts

Item No.	Part No.	Description	Qty.
1	131322	Battery bracket (Opt)	1
2	131323	Battery, rechargeable (Opt)	1
3	131321	Backplate, back plane base	1
4	14626	Nut, Kep 8-32 NC Hex	4
5	131326	Lock washer, external tooth	1
6	131328	Screw, 4-40 x 0.3125	1
7	131333	Ground clamp, 3/16 Ø	3
	164580	Ground Clamp, 1/4 Ø	1
8	131334	Ground wire, insulated	2
9	131340	Bracket for option module	1
10	131341	Analog output, 0-10 VDC, 4-20 mA	1
	131342	Relay board, 2 inputs, 4 relays	1
	164600	USB/Ethernet TCP/IP	1
11	131327	Screw, 4-40 x 0.188	8
13	170537	Overlay, 482_AG membrane	1
14	131343	Enclosure, front	1
15	153776	Display board, LCD 7 segment	1
16	131316	Power supply, 85-265 VAC	1
17	131317	Battery charger, VDC to VDC (Opt)	1
18	131318	Board assembly, CPU	1
19	131319	Board, assembly, A/D	1
20	131324	Screw, 4-40 drilled fillister head	1
21	131325	Screw, 8-32 drilled fillister head	1
22	131335	O-ring	2
23	15626	Cord-grip, PG9	4
24	30375	Seal ring, nylon PG9	4
25	131336	Calibration cover (Opt)	1
26	131337	Washer, rubber	2
27	131344	Gasket, backplate	1
28	14862	Screw, 8-32NC x 3/8	4
29	45042	Washer, bonded sealing 8 x 0.375	4
30	164912	Tilt Stand	1
31	164577	Knob and washer, M6 thread	2
32	164579	Cover, A/D Sealing	1

Table 2-3. Parts List

Item No.	Part No.	Description	Qty.
-	164604	Ethernet cable with cord grip, 6 ft	1
	164602	USB cable with cord grip, type A female 20 cm	1
	167707	USB cable with cord grip, type A male 200 cm	1
	167708	USB cable with cord grip, type B male 200 cm	1
	88733	Vent, breather vent	1
	88734	Nut, breather vent	1
	103462	2-position screw terminal	1
	76513	4-position screw terminal	1
	76514	6-position screw terminal	2
	157223	15-position screw terminal	1
	155230	Ribbon cable CPU to display	1
	155231	Ribbon cable CPU to A/D	1
	155232	Ribbon cable PS to CPU Board	1
	155233	Ribbon cable CPU to Option	1
	155234	Pwr cord 115 VAC, NEMA Type 5-15 plug	1
	155235	Pwr cord 230 VAC, Euro CEE 7/7	1

Table 2-3. Parts List (Continued)

Part No.	Description	Qty.
94422	Label, Capacity	1
85555	Label, Annunciators	1
14862	Screw, 8-32NCx3/8	8
45042	Washer, Bonded Sealing #8 x 0.375	8
76514	Conn, 6-Pin for LC and RS-232 ports	2
103462	Conn, 2- Pin for 20 mA port	1
131325	Screw, Fillister 8-32NC x 1/4	1
131320	Screw, Fillister 8-32NC x 1/2	1

Table 2-4. Parts Kit

3.0 Configuration

The 482-AG indicator can be configured using a series of menus accessed through the indicator front panel when the indicator is in configuration mode. To enter the configuration mode:

1. Remove setup switch access screw from back of indicator. See [Figure 2-1 on page 14](#).
2. Using a non-conductive tool, press the button located in the access hole. **CONFIG** displays. See [Section 1.4 on page 9](#) for menu navigation instructions.

The **CONFIG** menu is the first of seven main menus used to configure the indicator. Detailed descriptions of these menus are given in this chapter. When configuration is complete, return to **CONFIG** and press the **Zero** Δ to exit configuration mode and save changes. Replace the configuration switch access screw.

Menu		Required Password	Description
CONFIG	Configuration	Config	Graduations (scale capacity), configure zero tracking, zero range, motion band, overload, tare function, sample rate and digital filtering parameters. Section 3.1 on page 24 .
FORMAT	Format	Config	Set primary and secondary units. Section 3.1.3 on page 28 .
CALIBR	Calibration	Config	Calibrate the indicator. Section 3.2 on page 29 .
PROGRM	Program	Config	Set power-up and regulatory modes, consecutive numbering and sleep parameters. Section 3.3 on page 30
PASWRD	Password	Config	Enable and edit configuration and user passwords. Section 3.4 on page 32
TEST	Test	Config	Test A/D, Test and set Digital I/O; reset indicator to default settings, set over and under weighment characteristics. Section 3.5 on page 32
MENU	Menu	User	Non Legal for Trade settings, Audit Trail, set Unit ID, set Time/Date, Communication Port, Print Format parameters, Firmware/Software Versions. Section 3.6 on page 33

Table 3-1. 482-AG Menu Summary

3.1 Configuration Menu

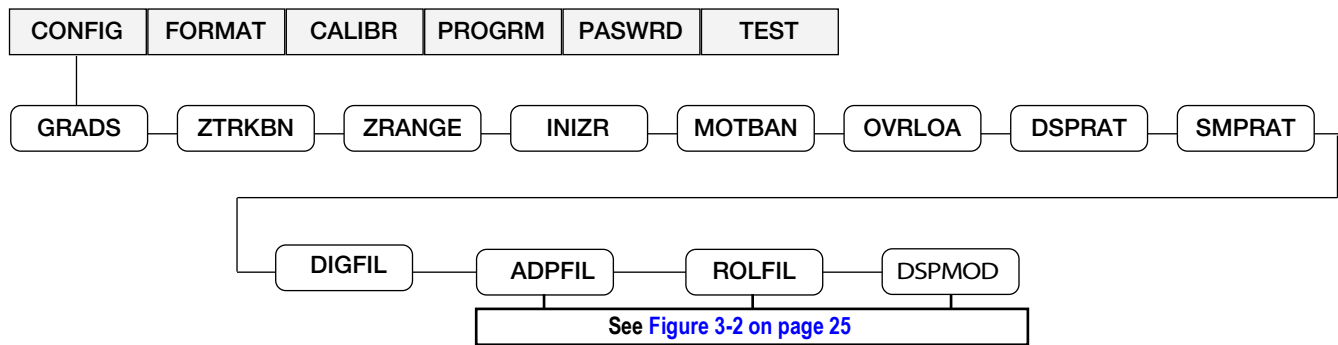

Figure 3-1. Configuration Menu

Parameter	Settings	Description
GRADS	4000 1 – 100000	Graduations – specifies the number of full scale graduations; the value entered must be in the range of 1–100,000 and should be consistent with legal requirements and environmental limits on system resolution
ZTRKBN	0.6 dd 0.0 – 3.0dd	Zero track band – automatically zeros the scale when within the range specified, as long as the input is within the configured zero range (ZRANGE parameter); selections are \pm display divisions; maximum legal value varies depending on local regulations
ZRANGE	2% 1%–100%	Zero range – selects the range within which the scale can be zeroed; the 2% selection is \pm 2% around the calibrated zero point, for a total range of 4%; indicator must be at standstill to zero the scale
INIZR	0% 0–100%	Initial zero range at power up; see Error messages HINOFF and LINOFF in Section 8.1 on page 54 ; if on power up, the weight value is between the \pm % range specified of Calibrated Zero, the indicator will zero off that weight; if outside that range, the indicator will display HINOFF or LINOFF, depending on whether the initial reading is above or below the range NOTE: If not set at zero, hopper/scale MUST be empty when powered up.
MOTBAN	1.0d 0.0d–100d	Motion band – sets the level, in display divisions, at which scale motion is detected; if motion is not detected, the standstill symbol lights; some operations, including print, tare and zero, require the scale to be at standstill; maximum legal value varies depending on local regulations NOTE: Setting the MOTBAN setting to 0.0 disables motion sensing and the scale will always be considered stable.
OVRLOA	FS+2% FS+1D FS+9D FS	Overload – determines the point at which the display blanks and an out-of-range error message is displayed; maximum legal value varies depending on local regulations
DSPRAT	0.1 SEC 0.25 SEC 0.5 SEC 0.75 SEC 1 SEC NONE	Display rate – sets the update rate for displayed values; Values are in seconds (SEC) No display filtering – the display is updated at up to the A/D sample rate
SMPRAT	5HZ 10HZ 20HZ 40HZ	A/D Sample rate – selects measurement rate, in samples per second, of the analog-to-digital converter; lower sample rate values provide greater signal noise immunity
DIGFIL	ROLFIL OFF ADPFIL	The digital filter setting determines which if any digital filter option is used <ul style="list-style-type: none"> • ROLFIL - Rolling Average Filter • OFF - Disables digital filter • ADPFIL - Adaptive Filter
ADPFIL	--	Adaptive Filter parameter settings, see Section 3.1.1 on page 25
ROLFIL	--	Rolling Average Filter parameter settings, see Section 3.1.1 on page 25
DSPMOD	--	Display Mode parameter settings, see Section on page 27

Table 3-2. Configuration Menu Parameters

3.1.1 Digital Filtering

Digital filtering is used to create a stable scale reading in challenging environments. The 482-AG (firmware version 1.03 and later) allows for the selection of adaptive filtering, rolling filtering or off for no filtering. The A/D sample rate must be selected first. Then select the type of digital filter using the **DIGFIL** parameter.

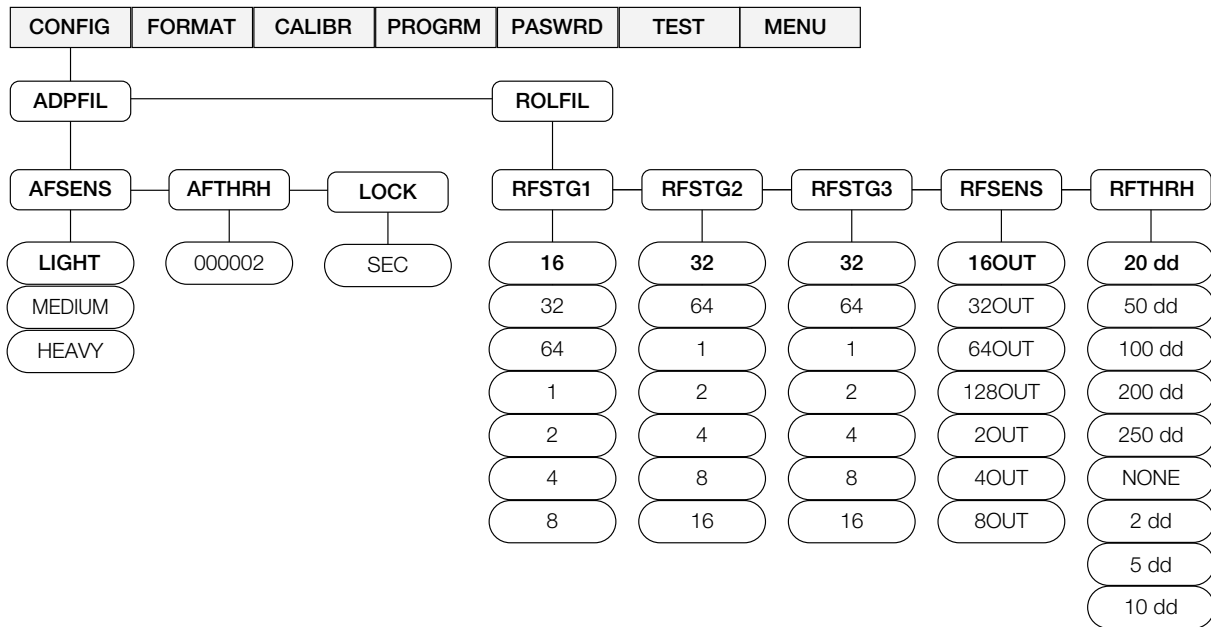

Figure 3-2. Adaptive Filter and Rolling Averaging Filter Sub-menu

Parameter	Settings	Description
AFSENS	LIGHT MEDIUM HEAVY	Digital filter cutout sensitivity – the light setting responds quickly to small weight changes and is less stable; the heavy setting responds slowly to small weight changes and is more stable; use the heavy setting in an unstable environment
AFTHRH	000002	Digital filter cutout threshold – specifies the filter threshold, in weight value; when a weight change exceeds the value set for threshold, digital filtering is suspended; a setting of 0 disables the filter; the decimal point in the entered value is assumed; if the dd is 1 lb, a value of 1 is equal to 1 lb; if the dd is 0.1 lb, a value of 1 is equal to 0.1 lb
LOCK	SEC	The lock setting prevents the filter from resetting adaptive filtering; The threshold will not reset filtering until the specified lock time is met
RFSTG1 RFSTG2 RFSTG3	2 4 8 16 32 64 1	Rolling filter stages – the number of A/D samples that are averaged in each stage; a higher number gives a more stable display by minimizing the effect of a few noisy readings, but slows down the settling rate of the indicator RFSTG1 Default - 16 RFSTG2 Default - 32 RFSTG3 Default - 32
RFSENS	8OUT 16OUT 32OUT 64OUT 128OUT 2OUT 4OUT	Rolling filter cutout sensitivity – specifies the number of consecutive readings that must fall outside the rolling filter threshold (RFTHRH parameter) before digital filtering is suspended; if NONE is selected, the filter is always enabled
RFTHRH	NONE 2 dd 5 dd 10 dd 20 dd 50 dd 100 dd 200 dd 250 dd	Rolling filter cutout threshold – specifies the rolling filter threshold, in display divisions; when a specified number of consecutive scale readings (RFSENS parameter) fall outside of this threshold, digital filtering is suspended; if NONE is selected, the filter is always enabled

Table 3-3. Adaptive Filter Parameters

Adaptive Filter

The adaptive filter (**ADPFIL**) has two settings, sensitivity and threshold. The adaptive filter maintains a running average of the A/D readings when the weight change remains less than the defined threshold value. The filter automatically applies less value to each successive A/D reading the longer the weight change is less than the threshold value. The amount of value given to the most recent A/D reading is determined by the sensitivity setting.

Adaptive Filter Sensitivity (**AFSENS**)

The adaptive filter sensitivity can be set to heavy, medium or light. A heavy setting will result in an output that is more stable to weight changes, than that of light. However, small changes in weight data (a few grads) on the scale base will not be seen as quickly.

If the difference in typical subsequent weight values on the scale will only be a few grads, use a light setting. On a scale where the changes in subsequent weight values will be hundreds of grads, a heavy setting is more appropriate. When the weight has not exceeded the adaptive filter threshold setting, the effective response is approximately 30 A/D cycles for a light setting, 90 A/D cycles for a medium setting and 180 A/D cycles for a heavy setting.

Adaptive Filter Threshold (**AFTHR**)

The adaptive filter threshold should be set for the amount of observed instability in the system. This parameter can be set in the range of 0 to 99999 and is entered as a weight value. When a new sampled weight value is acquired, the adaptive filter compares the new value to the previous (filtered) output value.

If the difference between the new value and the previous output value is greater than the adaptive filter threshold, the adaptive filter is reset to the new weight value.

If the difference between the new value and the previous output value is less than the adaptive filter threshold, the two values are averaged together using a weighted average. The weighted average is based on the amount of time the system has been stable, and the selected adaptive filter sensitivity.

With the adaptive filter threshold set at zero, determine the amount of instability that is present. Enter this amount of weight instability to set the threshold of the adaptive filter. The adaptive filter is set to OFF when the adaptive filter threshold parameter is set to zero.

Rolling Averaging Filter

The Rolling Averaging Filter (ROLFIL) uses mathematical averaging with three stages. These configurable stages control the effect of a single A/D reading on the displayed weight. When an A/D reading is encountered that is outside a predetermined band, the rolling averaging filter is overridden, and the display jumps directly to the new value.

Filter Stages (**RFSTG1-3**)

The filter stages can each be set to a value of 1 to 64. The value assigned to each stage sets the number of readings received from the preceding filter stage before averaging. Setting the filter stages to 1 effectively disables the rolling filter.

A rolling average passes through three filtering stages. Those filtering stages are a weighted average of the product and have assigned values of (**RFSTG1** x **RFSTG2** x **RFSTG3**). That end value falls within a time frame corresponding to the sum of the values (**RFSTG1** + **RFSTG2** + **RFSTG3**).

Example: if RFSTG1=5, RFSTG2=2, RFSTG3=15, then the rolling average = 6.82.

(5 x 2 x 15 = 150) divided by (5 + 2 + 15 = 22) = 6.82

Filter Sensitivity (**RFSENS**) and Threshold (**RFTHRH**)

The rolling averaging filter can be used by itself to eliminate vibration effects, but heavy filtering also increases settling time. The **RFSENS** and **RFTHRH** parameters can be used to temporarily override filter averaging and improve settling time.

- **RFSENS** specifies the number of consecutive A/D readings that must fall outside the filter threshold before filtering is suspended
- **RFTHRH** sets a threshold value, in display divisions; When the specified number of consecutive A/D readings fall outside of this threshold, filtering is suspended; Set **RFTHRH** to **NONE** to turn off the filter override; Adaptive Filter and Rolling Filter Sub-menu Parameters

Setting the Rolling Averaging Filter Parameters

1. Set the rolling filter stage parameters (**RFSTG1-3**) to 1.
2. Set the Rolling Filter Cutout Threshold (**RFTHRH**) to **NONE**.
3. Return to the weigh mode.
4. Remove all weight from the scale, then watch the indicator to determine the magnitude of vibration effects on the scale.
5. Record the weight below which all but a few readings fall. This value is used to calculate the **RFTHRH** parameter in step 8.
Example – if a heavy-capacity scale (10000 x 5 lb) produces vibration-related readings of up to 50 lb, with occasional spikes to 75 lb, record 50 lb as the threshold weight value.
6. Place the indicator in configuration mode and set the rolling filter stage parameters (**RFSTG1-3**) to eliminate the vibration effects on the scale. Leave **RFTHRH** set to **NONE**.
7. Determine the lowest effect value for the **RFSTG1-3** parameters. If needed, the rolling filter cutout sensitivity (**RFSENS**) and the rolling filter cutout threshold (**RFTHRH**) can be used to reset the averaging filter so the response to a rate change is faster.
8. Calculate the **RFTHRH** parameter value by converting the weight value recorded in Step 5 to display divisions: (Threshold_Weight_Value / Display_Divisions).
In the example in Step 5, with a threshold value of 50 lb, and a display divisions value of 5 lb, **RFTHRH** should be set to 10DD.
9. Set the **RFSENS** parameter high enough to ignore transient peaks. Longer transients (typically caused by lower vibration frequencies) will cause more consecutive out-of-band readings, so **RFSENS** should be set higher to counter low frequency transients.

3.1.2 Display Mode Parameters

Parameter	Settings	Description
GROUP	WGDELTA	Weight Delta – percentage that the display value must drop before the scale returns to live weighing; valid values are 0-99%. Default: 00
LIVE	—	Live Mode – if enabled, the indicator always displays the current scale weight
HOLD	SPTIME	Display Mode Sampling Time – amount of time in seconds that the indicator will sample the scale before it displays the average of those samples; Valid values are 1-10 seconds; Default: 2
	HDELTA	Hold Delta – percentage that the display value must drop before the scale returns to live weighing; valid values are 0-99%. Default: 00
	HDTHRS	Hold Delta Threshold – when the weight reaches the threshold value, the HDELTA function is disabled; valid values are 0000 - 9999; Default: 500

Table 3-4. Display Mode Parameters

3.1.3 Format Menu

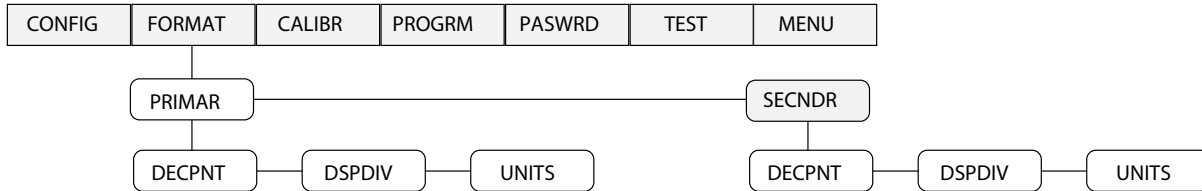

Figure 3-3. Format Menu

Parameter	Choices	Description
PRIMAR SECNDR	DECPNT DSPDIV UNITS	Primary Units – specifies the capacity, decimal position, display divisions, and units used Secondary Units – specifies the capacity, decimal position, display divisions, units and conversion multiplier used, see Sub-menu parameters below for descriptions
Sub-menus		
DECPNT	888888 8.88888 88.8888 888.888 8888.88 88888.8	Decimal point location – specifies the location of the decimal point in the primary unit display; value should be consistent with local legal requirements Primary default – 888888 Secondary default – 88888.8
DSPDIV	1d 2d 5d 10d 20d 50d	Enter divisions (external) in primary units – scale resolution will be determined by the formula $CAP / DIV = Resolution$ Primary default – 5d Secondary default – 2d
UNITS	LB KG OZ TN T G	Specifies primary units for displayed and printed weight; Values are: lb = pound; kg = kilogram; OZ = ounce; TN = short ton; T = metric ton; G = gram Primary default – LB Secondary default – KG NOTE: Indicators sold outside North America are configured with kg for both primary and secondary units.

Table 3-5. Format Menu Parameters

Conversion Factors for Secondary Units

The 482-AG has the capability to mathematically convert a weight into many different types of units and instantly display those results with a press of the **UNIT** key. Secondary units can be specified on the **FORMAT** menu using the **SECNDR** parameter.



NOTE: Multipliers are preconfigured within the indicator.

Ensure that the secondary decimal point position is set appropriately for the scale capacity in the secondary units. If the converted value requires more digits than are available, the indicator will display an overflow message (OVERFL).

For example, if the primary units are short tons, secondary units are pounds, and the secondary decimal point is set to 8888.88, the indicator will overflow if 5 tons or more are applied to the scale. With 5 tons applied, and a conversion factor of 2000, the secondary units display needs five digits to the left of the decimal point to display the 10000 lb secondary units value.

3.2 Calibration Menu

See [Section 4.0 on page 42](#) for calibration procedures.

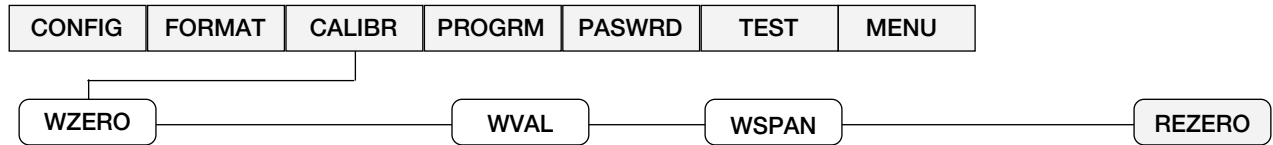

Figure 3-4. Calibration Menu

Parameter	Choices	Description
WZERO	CAL	Do not adjust this value after WSPAN has been set; press ∇ to display ENTER then press \leftarrow to capture the zero value
	EDIT	Press ∇ to display the current captured zero mV value; the value may be edited as required; press \leftarrow to save the edited value
WVAL	—	Press ∇ to display the test weight value; The value may be edited as required; press \leftarrow to save the edited value
WSPAN	CAL	Press ∇ to display ENTER then press \leftarrow to capture the net span value
	EDIT	Press ∇ to display the current captured net span mV value; the value may be edited as required; press \leftarrow to save the edited value
REZERO	ZERO (flashing)	Press \leftarrow to remove the weight of the testing apparatus like hooks or chains used during the calibration process; always use this parameter after WZERO and WSPAN have been set to recapture a new zero value

Table 3-6. Calibration Menu Parameters

3.3 Program Menu

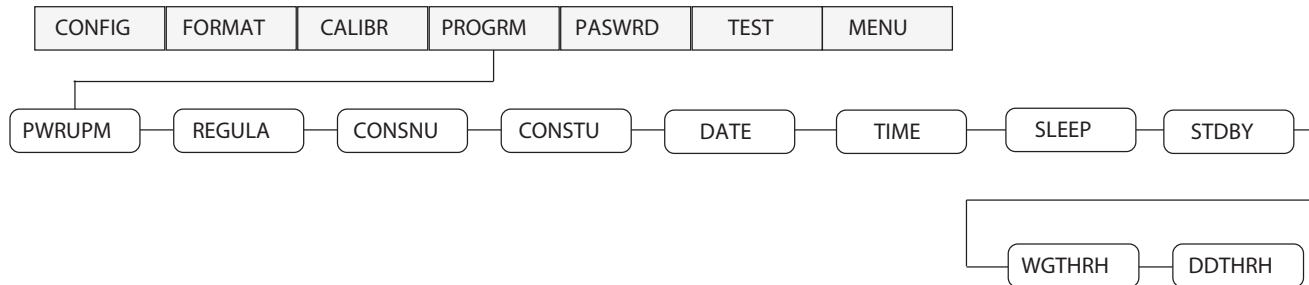

Figure 3-5. Program Menu

Parameter	Choices	Description
PWRUPM	GO DELAY	The power up parameter has two settings. In GO mode, the instrument goes into operation immediately after a brief power up display test; In DELAY mode, the instrument performs a power up display test and then enters a 30 second warm-up period; If no motion is detected during the warm-up period, the instrument becomes operational when the warm-up period ends; If motion is detected, the delay timer is reset and the warm-up period repeated
REGULA	NTEP OIML CANADA NONE	The regulatory parameter specifies the regulatory agency having jurisdiction over the scale site
CONSNU	000000 0 – 999999	The consecutive number parameter is a read only value; The consecutive number value will increment following each print operation when the print format used contains the <CN>, or consecutive number formatting token; NOTE: The initial value of this parameter is set to the start up value specified on the CONSTU parameter. Changing CONSTU immediately resets the consecutive number used for printing.
CONSTU	000000 0 – 999999	The consecutive number start up parameter specifies the initial consecutive number (CONSNU) value used when the instrument is reset or configured NOTE: Consecutive numbering starts with number entered Example: If 100 is entered the first ticketed printed will be 100.
DATE	DATFMT	Specifies the format used to display or print the date <ul style="list-style-type: none"> • MMDDYY • DDMMYY • YYMMDD • YYDDMM
	DATSEP	Specifies the date separator character <ul style="list-style-type: none"> • SLASH • DASH • SEMI
TIME	TIMFMT	Specifies the format used to display or print the time <ul style="list-style-type: none"> • 12HOUR • 24HOUR
	TIMSEP	Specifies the time separator character <ul style="list-style-type: none"> • COLON • COMMA
SLEEP	NEVER 1MIN 2MIN 5MIN 10MIN	The sleep parameter defines the amount of time to elapse before the instrument will enter the sleep mode when the following conditions are met: the weight is stable, no keys have been pressed, and the weight is below the sleep weight threshold WGTHRH . A setting of NEVER will disable the sleep mode. See Section 3.3.1 on page 31 . NOTE: The sleep mode will activate only if the instrument is operating on the optional internal battery. If the instrument is connected to an external AC power source, it will not go into sleep mode regardless of the parameter settings. Setting the WGTHRH or DDTHRH parameters to 0 also disables the sleep mode.

Table 3-7. Program Menu Parameters

Parameter	Choices	Description
STDBY	1SEC 2SEC 3SEC 5SEC 10SEC 60SEC OFF	The standby parameter determines the amount of time to elapse before the instrument will wake briefly, when in the sleep mode, and check for the following conditions: <ul style="list-style-type: none"> • there is weight on the scale of more than the WGTHRH value • the weight has changed greater than DDTHRH value • the instrument detects that a key is pressed
WGTHRH	000000 0 – FS (in primary units)	The weight threshold determines a weight, at which below this setting, the instrument will enter the sleep mode, providing the weight remains stable, no keys are pressed and the amount of time set in the SLEEP parameter has elapsed. If the weight is above this setting the instrument will not go into sleep mode.
DDTHRH	000001 999999 (in display divisions)	The display division threshold parameter determines the weight change detection feature of sleep mode. Once the instrument detects that the weight amount on the scale has changed more than the DDTHRH setting, it will wake up.

Table 3-7. Program Menu Parameters (Continued)

3.3.1 Sleep Mode

The indicator will enter the sleep mode, after the time specified in the **SLEEP** parameter, when no keypad activity is detected and the displayed weight is below the weight threshold (**WGTHRH**). Setting the sleep parameter to **NEVER** disables the sleep mode.

Standby Parameter

While in sleep mode, at a time specified in the standby (**STDBY**) parameter, the indicator wakes up for about 0.5 seconds. The range of the standby time is 1 to 60 seconds. During the awake time, it checks for a change in weight greater than the display division threshold (**DDTHRH**), or if the weight has gone above the weight threshold (**WGTHRH**). The indicator also checks to see if a key is being pressed, and it performs zero tracking.

*Example: If the standby parameter (**STDBY**) is set to 1 second, the weight threshold (**WGTHRH**) is set to 100, and the display division threshold (**DDTHRH**) is set to 10d, when in sleep mode, the indicator will wake up every second for about half a second to check to see if a key is being pressed, the weight threshold is over 100, or the weight has change more than 10d since the last time it checked.*

Setting the standby parameter to a higher value reduces the amount of time the indicator is awake and will increase battery life.

The **OFF** setting stops the indicator from waking up; then, to wake up the indicator the power key must be pressed.



NOTE: The indicator only checks for a depressed key during the time it is awake, so key presses may not be detected, especially if the standby parameter is set to a longer time. The power key will always wake the indicator.

3.4 Password Menu

The Password menu is used to set or edit passwords.



Figure 3-6. Password Menu

Parameter	Settings	Description
CNFG	000000 0 – 999998	The configuration password, if enabled, is used for electronic sealing of the indicator. Once a configuration password has been set, the existing configuration password is required before the password can be edited. Entering this menu requires the configuration switch to be pressed. 000000 = no password
USER	000000 0 – 999998	The user password, if enabled, restricts access to the serial and print formatting menus. Once a user password has been entered, the existing user password is required before the password can be edited. 000000 = no password

Table 3-8. Password Menu Parameters

! **IMPORTANT:** Enter 999999 to reset either password. This reset can also be used in the event a password is forgotten. Entering 999999 will reset the configuration of the scale to default values.

3.5 Test Menu

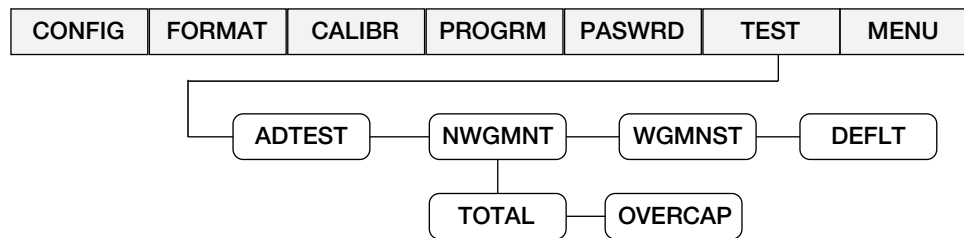

Figure 3-7. Test Menu

Parameter	Choices	Description
ADTEST	—	Displays raw A/D counts
NWGMNT	TOTAL	The number of weighments that exceed value set in WGMNST
	OVECAP	The number of weighments that exceed the capacity of the scale as set in the config and format menus, see Section 3.1 on page 24 and Section 3.1.3 on page 28
WGMNST	0–999999	Weightment Threshold – sets the weight threshold over which WGMNST/Over value will be counted
DEFLT	—	Resets all parameters to factory defaults; at DEFLT, press GROSS/NET, indicator will display SAVING and cycle power

Table 3-9. Test Menu Parameters

3.6 Menu Parameters

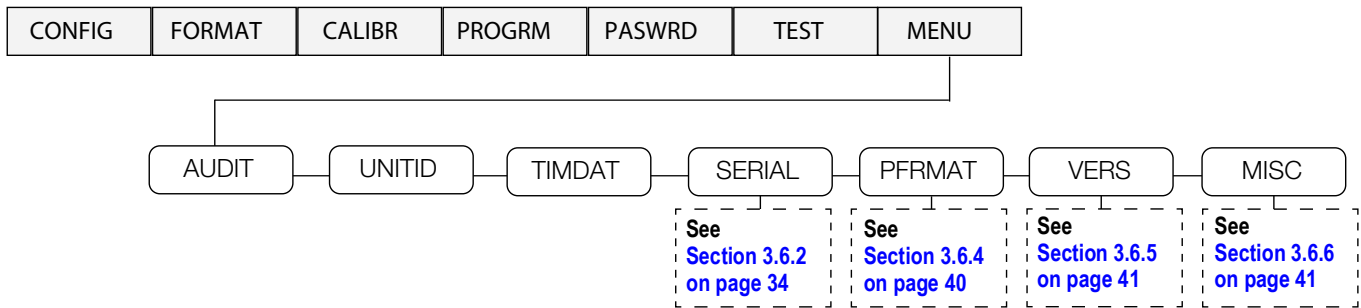

Figure 3-8. Menu

Parameter	Settings	Description
AUDIT	CALIB CONFIG	View audit trail including the time and date of last configuration or calibration; options: CNT, TIME, DATE
UNITID	0-999999	View and edit the Unit ID (up to a six digit number)
TIMDAT	TIME DATE	View/set time and date as currently programmed in the indicator; format date as MMDDYY, DDMMYY, YYMMDD or YYDDMM
SERIAL	COM-1 COM-2 STREAM	Configure serial ports, see Section 3.6.2 on page 34
PFRMAT	GFMT GWFMT LTFMT	View or configure the print format used for gross, group weight and load total print tickets; see Section 3.6.4 on page 40 and Section 7.0 on page 52 for more information
VERS	FIRMW LR	Displays the firmware and legally relevant firmware currently installed
MISC	POWER BKLIGHT BAT	Set miscellaneous parameters; see Section 3.6.6 on page 41

Table 3-10. Menu Parameters

3.6.1 Audit Trail Support

Audit trail support provides tracking information for configuration and calibration events. To prevent potential misuse, all configuration and calibration changes are counted as change events.

Audit trail information can be printed by sending the **DUMPAUDIT** serial command. The audit trail display includes the legally relevant (**LR**) version number (firmware version for the code that provides audit trail information), a calibration count and, if **REGULA=NTEP** or **CANADA**, a configuration count. The exact format of the information shown depends on the regulatory agency specified for the **REGULA** parameter in the program (**PROGRAM**) menu ([Table 3-7 on page 30](#)).

For **NTEP and Measurement Canada modes**, there are two numbers displayed: configuration (**CONFIG**) and calibration (**CALIB**). The configuration number tracks changes to the legally relevant configuration parameter changes. The calibration number tracks changes to the scale calibration.

In **OIML Mode**, there is only one number displayed; Audit Trail. The Audit trail number is incremental for a legally relevant configuration parameter changes and all calibration changes. The last date the scale was calibrated is also displayed

3.6.2 Serial Menu

See [Section 3.6.3 on page 37](#) for information about the 482-AG serial data format.

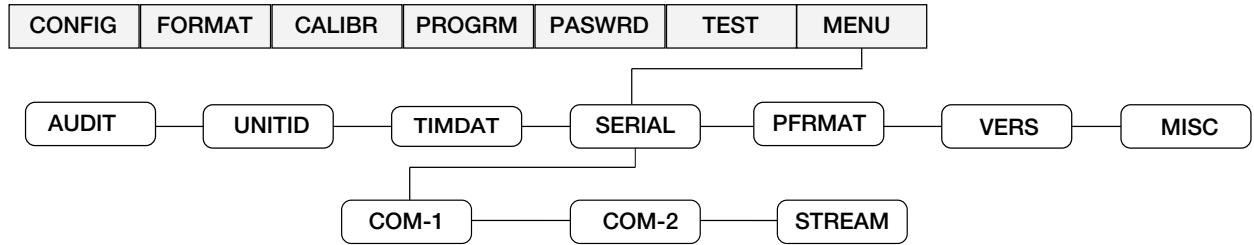

Figure 3-9. Serial Menu

Parameter	Choices	Description
COM-1	See Table 3-12 on page 35	Specifies settings for COM-1
COM-2	See Table 3-13 on page 35	Specifies settings for COM-2
STREAM	—	Stream parameters define the operating mode of the indicator, see Section 3.6.3 on page 37
	NONE	When the streaming parameter is set to NONE , the indicator operates normally; COM-2 will not stream, even if the TRIGGER is set to a streaming parameter (STR1-5)
	LOCAL	When the streaming parameter is set to LOCAL the indicator operates normally; data streaming occurs on COM-2 if the TRIGGER is set to stream data (STR1-5)
	REMOTE	When the streaming parameter is set to REMOTE , the indicator operates as a serial data scale and displays values based on a received stream of serial data into COM-2; the indicator also sends key press commands back through COM-2 to the LOCAL indicator

Table 3-11. Serial Menu Parameters

COM-1 Parameters

Parameter	Settings	Description
TRIGGER (COM-1)	—	The trigger parameter specifies the ports mechanism for triggering a transmission of data
	DEMAND	When set to a demand port, printing is performed by pressing the PRINT key or when a KPRINT EDP command is received; this port also allows operation and EDP commands
	PRN	When set to a printer port, printing is performed by pressing the PRINT key; the port does not allow operation of EDP commands
	NONE	When set to NONE , the port is inactive
	COMAND	When set to a command port, the port allows operation of EDP commands, but will not print
BAUD	9600 19200 38400 1200 2400 4800	The baud rate setting determines the transmission speed of data
BITS	8NONE 7EVEN 7ODD	The bits parameter determines the number of data bits and parity of data
SBITS	1 STOP 2 STOP	The stop bits parameter sets the number of stop bits to 1 or 2
TERMIN	CR/LF CR	The termination character parameter sets the line termination character(s) for data sent
EOLDLY	000 0 – 255	The end-of-line delay parameter specifies, in 0.1 second intervals, the delay between transmitted lines of data NOTE: An end-of-line delay may be required for continuous transmission at slower baud rates to ensure the receiving buffer is empty before another string is transmitted.
ECHO	ON OFF	The echo parameter specifies whether characters received by the port are echoed back to the sending unit
PRNMSG	OFF ON	The print message parameter determines if Print displays when a demand print is performed

Table 3-12. COM1 Parameters

COM-2 Parameters

Parameter	Settings	Description
TRIGGER (COM-2)	—	The trigger parameter specifies the ports mechanism for triggering a transmission of data
	NONE	When set to NONE , the port is inactive
	PRN	When set to a printer port, printing is performed by pressing the PRINT key; the port does not allow operation of EDP commands
	STR1	When set to STR1 the port is used to transmit a continuous stream of data according to RLWS stream format**
	STR2	When set to STR2 the port is used to transmit a continuous stream of data according to Toledo8142 stream format**
	STR3	When set to STR3 the port is used to transmit a continuous stream of data according to Cardinal738 stream format**
	STR4	When set to STR4 the port is used to transmit a continuous stream of data according to Weightronix WI-120 stream format**
STR5	When set to STR5 the port is used to transmit a continuous stream of data according to consolidated controls stream format**	
**STREAM must be set to local to enable streaming		
NOTE: See Section 3.6.3 on page 37 for more information on Stream formats. Com-2 streams simultaneously on both the RS-232 and 20mA outputs, see Figure 2-6 on page 16.		
BAUD	9600 19200 38400 1200 2400 4800	The baud rate setting determines the transmission speed of data

Table 3-13. COM2 Parameters

Parameter	Settings	Description
BITS	8NONE 7EVEN 7ODD	The bits parameter determines the number of data bits and parity of data
SBITS	1 STOP 2 STOP	The stop bits parameter sets the number of stop bits to 1 or 2
TERMIN	CR/LF CR	The termination character parameter sets the line termination character(s) for data sent
EOLDLY	000 0 – 255	The end-of-line delay parameter specifies, in 0.1 second intervals, the delay between transmitted lines of data <i>NOTE:</i> An end-of-line delay may be required for continuous transmission at slower baud rates to ensure the receiving buffer is empty before another string is transmitted
ECHO	OFF ON	The echo parameter specifies whether characters received by the port are echoed back to the sending unit
PRNMSG	OFF ON	The print message parameter determines if Print displays when a demand print is performed
STRUR	—	The stream update rate defines the data update rate when one of the stream formats is selected
	STRLFT	When set to stream Legal for Trade, the weight information in the data stream is updated at the same rate as the indicator's display
	STRIND	When set to stream industrial, the weight information in the data stream is updated at up to the A/D sample rate

Table 3-13. COM2 Parameters (Continued)

Streaming Parameters for Local and Remote Operation

For systems that require two locations, local/remote support provides function equivalent to that of a Legal for Trade remote display with keypad. Scale data from the local indicator is also displayed at the remote unit and keypad input from the remote allows transactions to be initiated from either the local or remote unit.

To configure for local/remote operation, set **STREAM** to local or remote. Once the local unit scale has been configured, use the **SERIAL** menu or serial commands to set the serial parameters for local/remote operation. See [Table 3-12 on page 35](#) and [Table 3-13 on page 35](#) for Com port parameters.

Serial Configuration Parameter	Local Unit		Remote Unit	
	Parameter Value	Function	Parameter Value	Function
STREAM	Local	Stream Continuous Data	Remote	Sets indicator to display the weight data sent from the Local Unit
COM2.TRIGGER	Select STR-1	Streams the local unit weight data to the remote unit	Select STR-1	Transmits demand key presses, zero, units
COM2.BAUD	Local and remote must match			
COM2.ECHO	OFF		OFF	

Table 3-14. Local/Remote Configuration

The printing operation can be performed at the remote unit and/or at the local unit. When the operator presses the **Print** key at the local unit, a printing ticket will be issued locally only. When the operator presses the **Print** key at the remote unit, printing will occur at the remote unit only.

3.6.3 Continuous Data (Stream) Output Formats

When the trigger setting for COM-2 is set to one of the stream formats (STR1-STR5), or the Ethernet client or server trigger setting is STRLFT or STRIND, data is continuously streamed from the appropriate port in one of the five fixed formats that follow.

Rice Lake Stream Data Format

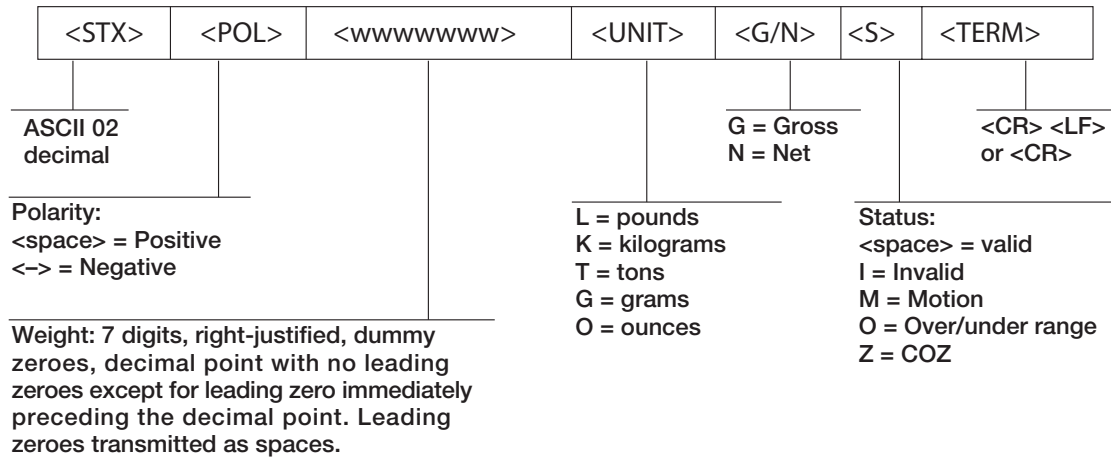
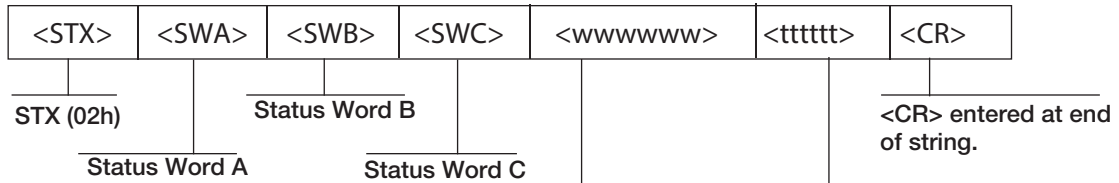

Figure 3-10. STR-1 Rice Lake Stream Data Format

Toledo Stream Data Format



Six digits, right justified, dummy zeros, decimal point with no leading zeroes except for immediately preceding the decimal point. Leading zeroes transmitted as spaces.

Tare Weight: Six digits, right justified, dummy zeros, decimal point with no leading zeroes except for immediately preceding the decimal point. Leading zeroes transmitted as spaces.

Status Word A:

	7	6	5	4	3	2	1	0
Parity	0	1	MUL1	MUL0	DP2	DP1	DP0	

Even parity bit.
Requires EDP Port setup.

Disp. Div.
MUL1 MUL0 Multiplier
0 1 x 1
1 0 x 2
1 1 x 5

DP2 DP1 DP0 Fixed Zero/Dec. Pt. Location
 0 0 0 x 100 (2 fixed zeroes)
 0 0 1 x 10 (1 fixed zero)
 0 1 0 x 1 (No decimal point)
 0 1 1 x 0.1 (1 decimal place)
 1 0 0 x 0.01 (2 decimal places)
 1 0 1 x 0.001 (3 decimal places)
 1 1 0 x 0.0001 (4 decimal places)
 1 1 1 x 0.00001 (5 decimal places)

Status Word C: ASCII 20h (space)

	7	6	5	4	3	2	1	0
Parity	0	1	0	0	0	0	0	0

Even parity bit:
Requires EDP Port setup.

Status Word B:

	7	6	5	4	3	2	1	0
Parity	0	1						

Even parity bit:
Requires EDP Port setup.

0 = lb
1 = kg

0 = Stable
1 = Motion

0 = Gross Display Mode
1 = Net Display Mode
0 = Positive indicated weight value
1 = Negative indicated weight value
0 = In range
1 = Out of range

Figure 3-11. STR-2 Toledo Stream Data Format

Weightronix Stream Data Format

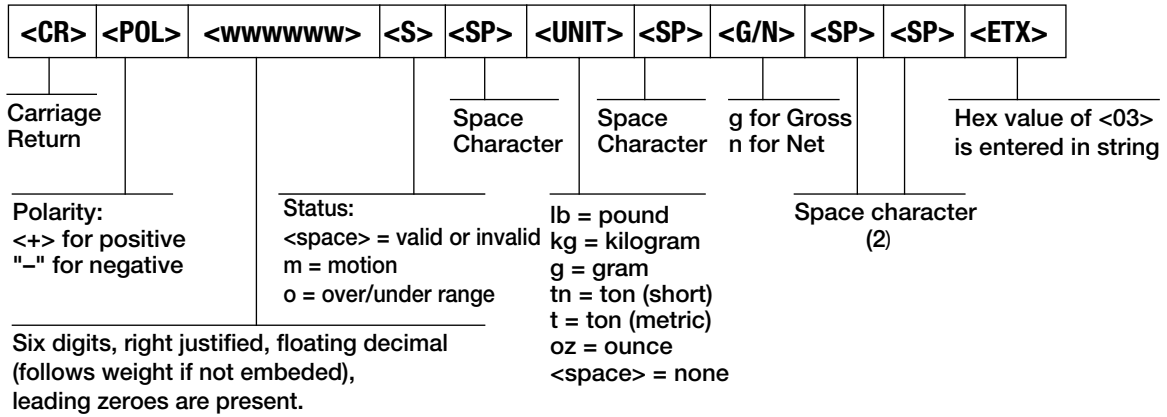

Figure 3-12. STR-3:Weightronix Stream Data Format

Cardinal Stream Data Format

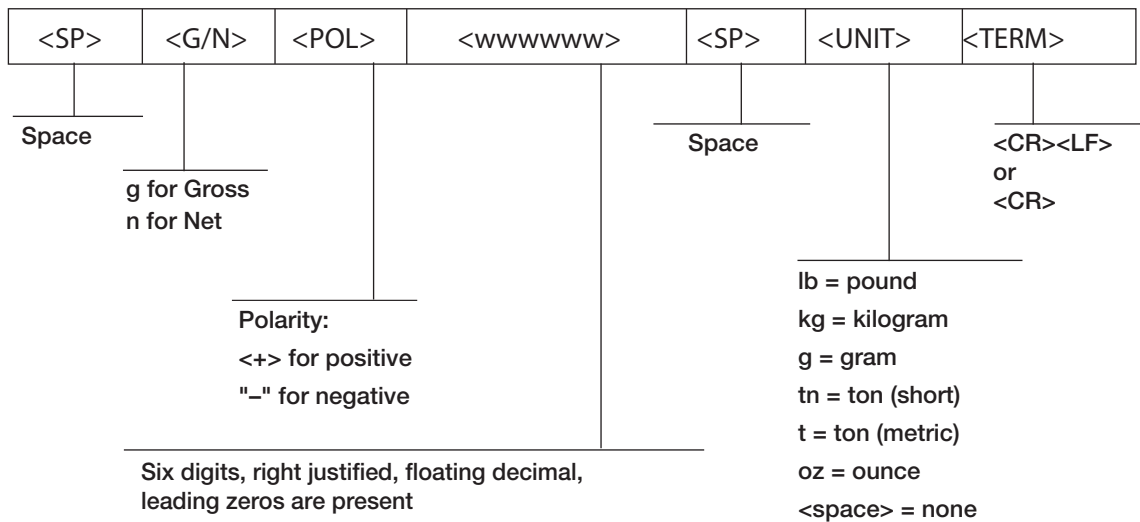

Figure 3-13. STR-4 Cardinal Stream Data Format

Consolidated Controls Stream Data Format

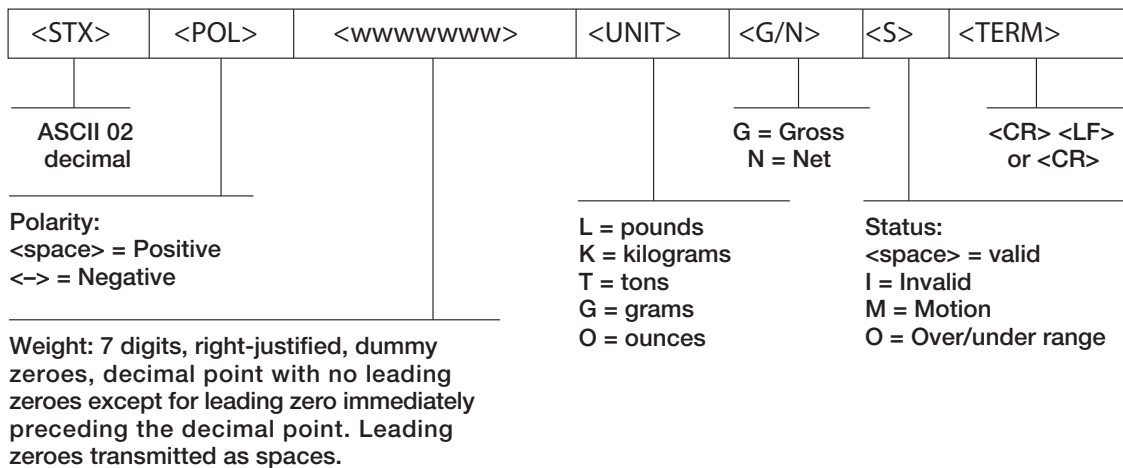

Figure 3-14. STR-5: Consolidated Controls Stream Data Format



NOTE: Port 1 cannot be set to stream.

3.6.4 Print Format Menu

The PFRMAT menu is used to change the print format. See [Section 7.0 on page 52](#) for information on custom print formatting.

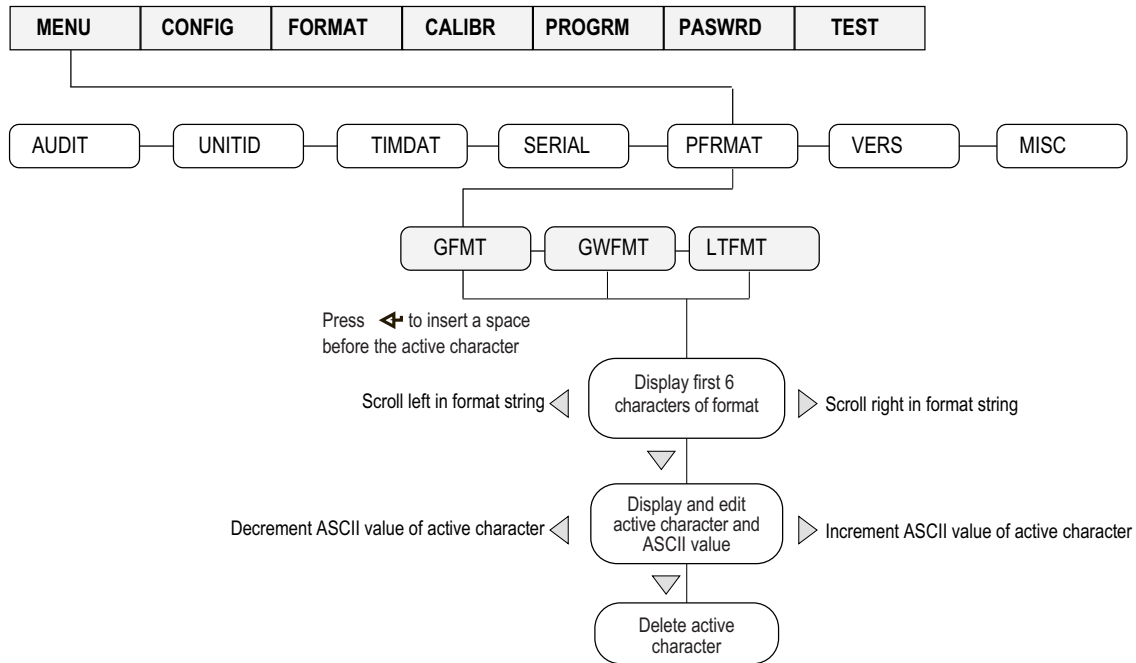

Figure 3-15. Print Format Menu

Parameter	Description
GFMT	Gross demand print format string Default – GROSS<G><NL2><TD><NL>
GWFMT	Group Weight format string Default – <NL2><TD><NL>Group Number:<GN><NL>Head Count:<HC><NL>Weight:<G><NL>Average Weight:<AG><NL>
LTFMT	Load Total format String Default – <NL2><TD><NL>Total Group Nm:<TGN><NL>Total Group Weight:<TGW><NL>Total Head Count:<THC><NL>Shrink Factor:<SF><NL>Total Group Weight w/Shrink:<TGWS><NL>Total Group Average:<TGA><NL>

Table 3-15. Print Format Parameters



NOTE: Format strings are case sensitive and must be entered in upper case. See [Section 8.3 on page 58](#) for a description of the seven-segment LCT character set used to display alphanumeric characters on the 482-AG front panel.

3.6.5 Version Menu

The VERS menu is used to view the firmware version.

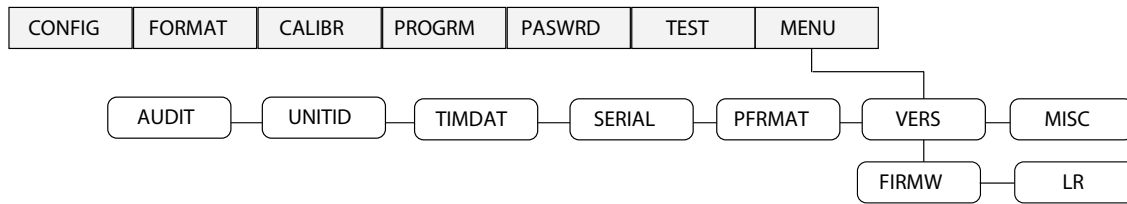

Figure 3-16. Firmware Version User Menu

Parameter	Description
FIRMW	Displays firmware version
LR	Displays legally relevant firmware version

Table 3-16. Firmware Version Menu Parameters

3.6.6 MISC Menu

The MISC menu is used to access the optional features of the device.

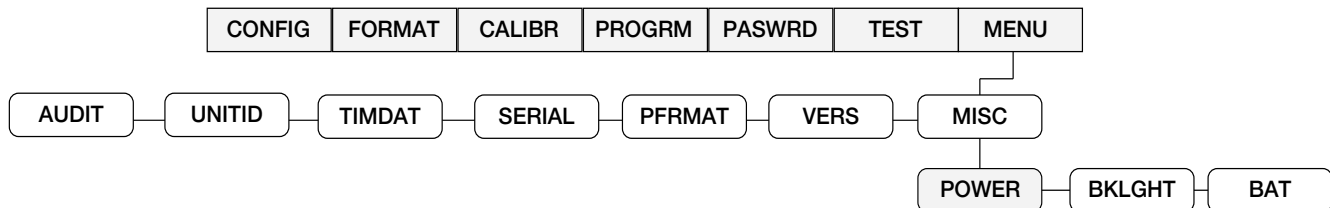

Figure 3-17. Misc. Menu

Parameter	Choices	Description
POWER	AUTO	The power up functionality depends on whether the battery option is installed: <ul style="list-style-type: none"> If the battery option is not installed, the indicator turns on automatically when connected to AC power; it turns off by disconnecting the AC power or by pressing the Power key If the battery option is installed, and CPU Jumper 4 is connected, the indicator turns on automatically when connected to AC power; it turns off by disconnecting the AC power or by pressing the Power key; this configuration is not recommended due to increased leakage current from the battery when the indicator is turned off If the battery option is installed, and CPU Jumper 4 is disconnected, the indicator only turns on and off by pressing the Power key
	MANUAL	Indicator powers ON/OFF by pressing Power key
BKLIGHT	OFF	When the backlight parameter is set to off, the backlight is always off
	ON	When the backlight parameter is set to on, the backlight is always on
	AUTO	When the backlight parameter is set to auto, the backlight will turn off after the configured amount of time, providing no keys are pressed and there is no change in the weight. When the backlight is off, once a key is pressed or the weight changes, backlight will turn on Auto backlight time Options: 10 sec, 30 sec, 1 min, 5 min, 10 min
BAT	LEVEL	Allows reading the battery level in mV units NOTE: If there is not a battery option installed, NOBATT displays. When the battery is charging, CHRNG displays. See Section 2.4 on page 17.

Table 3-17. Misc. Menu Parameters

4.0 Calibration

The 482-AG can be calibrated using the front panel. This chapter describes the calibration procedure for each of the calibration methods.

- Zero calibration
- Entering the test weight value
- Span calibration
- Optional rezero calibration for test weights using hooks or chains

4.1 Front Panel Calibration

The **CALIBR** sub-menu is used to calibrate the 482-AG, see [Section 3.2 on page 29](#) for the calibration menu structure and parameter descriptions. Use the following steps to calibrate the indicator using the front panel.

1. Remove the configuration switch access screw from the back of the enclosure, see [Figure 2-1 on page 14](#).
2. Insert a non-conductive tool into the access hole and press the configuration switch. **CONFIG** is displayed.
3. Press \triangleright until **CALIBR** is displayed.
4. Remove all weight from the scale platform. If the test weights require hooks or chains, place the hooks or chains on the scale for the zero calibration.
5. Press ∇ to **WZERO**.
6. Press ∇ to **CAL**.
7. Press ∇ to **ENTER**.
8. Press \leftarrow to calibrate zero. The indicator displays ***CAL*** while calibration is in progress. When complete, the mV value for the zero calibration is displayed.
9. Press \triangle to save the zero calibration. **CAL** is displayed.
10. Press \triangle to **WZERO**.
11. Press \triangleright to **WVAL**.
12. Press ∇ to show the test weight value.
13. Press ∇ to edit value using the procedure shown in [Section 1.7 on page 11](#) to enter the actual value of the test weights to be used for the span calibration. Press \leftarrow to store the entered **WVAL** value.
14. Press \triangle to **WVAL**.
15. Press \triangleright to **WSPAN**.
16. Press ∇ to **CAL**.
17. Press ∇ to **ENTER**.
18. Place test weights on the scale and press \leftarrow to calibrate span. The indicator displays ***CAL*** while calibration is in progress. When complete, the net millivolt value of the test weight for the span calibration is displayed.



NOTE: Net mV value is equal to the raw mV value at the span minus the mV value captured for zero.

19. Press \triangle to save the value. **CAL** is displayed.
20. Press \triangle to **WSPAN**. If using chains or hooks for the test weights, proceed with [Step 21](#). If no chains or hooks were used, proceed with [Step 24](#).
21. Press \triangleright to **REZERO**. The **REZERO** function is used to remove a calibration offset when hooks or chains are used to hang the test weights.
22. Remove the hooks or chains used during calibration and remove the test weights from the scale.
23. Press ∇ . **ZERO** will flash. With all weight removed, press \leftarrow to rezero the scale. This adjusts the zero and span calibration values. The indicator displays ***CAL*** while the zero and span calibrations are adjusted.
24. Press \triangle to return to the **CALIBR** menu.
25. Press \triangleleft until the display reads **CONFIG**.
26. Press \triangle to exit configuration mode. **Saving** is displayed and the scale returns to the weigh mode.



NOTE: The **INIZR** (initial zero) parameter may affect the weight display reading immediately following calibration.

4.2 EDP Command Calibration

To calibrate the indicator using EDP commands, the indicator COM 1 port must be connected to a terminal or personal computer, see [Section 6.0 on page 47](#) for more information about using EDP commands.

Once the indicator is connected to the sending device, use the following steps:

1. Place the indicator in configuration mode (display reads **CONFIG**) and remove all weight from the scale platform. If the test weights require hooks or chains, place them on the scale for zero calibration.
2. Send the SC.WZERO EDP command to calibrate zero. The indicator displays ***CAL*** while the calibration is in progress.
3. Place test weights on the scale and use the SC.WVAL command to enter the test weight value in the following format: **WVAL=nnnnnn<CR>**
4. Send the SC.WSPAN EDP command to calibrate span. The indicator displays ***CAL*** while the calibration is in progress.
5. To remove an offset value, clear all weight from the scale, including items used to hang test weights, and then send the SC.REZERO EDP command. The indicator displays ***CAL*** while the zero and span calibrations are adjusted.
6. Send the KUPARROW EDP command to exit configuration mode.

4.3 Adjusting Final Calibration

Calibration may be affected by environmental factors such as wind, vibration, and angular loading.

*Example: if the scale is calibrated with 1000 lb, a strain test may determine that at 2000 lb the calibration is 3 lb high. In this case, final calibration can be adjusted by tweaking **WVAL** to 998.5 lb. This adjustment provides a linear correction of 1.5 lb per 1000 lb.*

To adjust the final calibration, return to the **WVAL** prompt and press **←** to show the test weight value. Press **△** or **▽** to adjust calibration up or down. Press **↵** to save the value. Press **△** to return to the **CALIBR** menu.

5.0 Animal Weighing Operation

Weighing animals is done in groups of one or more animals. A load is made up of one or more groups. The 482-AG provides three modes for displaying the weight of the animals on the scale, **Group**, **Live** and **Hold**. Group mode is the default setting.

5.1 Group Mode Operation

Group mode can consist of weighing multiple groups prior to acquiring a load total. A head count must be entered and applied to each group.



5.1.1 Group Settings



When using the group mode, the **WGDELTA** parameter should be set prior to weighing, see [Section on page 27](#) for **WGDELTA** information. **WGDELTA** is the value the scale must fall below before processing another group.

5.1.2 Weighing Groups in Group Mode

Multiple groups of animals are weighed. Each group weight and data is printed. At the end of all group weighments, the data for all groups (load total) is summarized and printed.

1. Enter the shrink factor on the numeric keypad, if desired, and press , see [Section 1.8.4 on page 12](#).

 **NOTE:** A shrink factor can be entered at any time, but only the last shrink factor entered prior to pressing  will be applied to all of the groups making up the load.

2. Load the first group onto scale.
3. Enter the head count on the numeric key pad. See [Section 1.8.5 on page 13](#).
4. Press . The group information is sent to the serial port.
5. If a reprint of the individual group ticket is required, press  to resend the current data to the serial port.
6. For each group included in the load, repeat steps two through four.

 **NOTE:** Scale must fall below value identified in **WGDELTA**.

7. When all groups for a load are complete, press  and the load ticket data will be sent to the serial port. See [Figure 5-1 on page 45](#).

 **NOTE:** There is no reprint ability for the Load Total data

A new load can now be restarted. The group number on the printed ticket increments with each group. Pressing  resets the group number.

 **NOTE:** When the first group of a load is complete, an arrow annunciator, to the left of the zero annunciator, displays to signify the indicator is in the middle of collecting data from groups that make up a load, see [Section 1.6 on page 10](#).

When loading and unloading groups, the power standby mode may engage and power down the indicator. Once the indicator is powered back on, this annunciator signifies that the indicator is still in the middle of collecting load data. The previous group data totals are saved in case of a power down in the middle of collecting load groups.

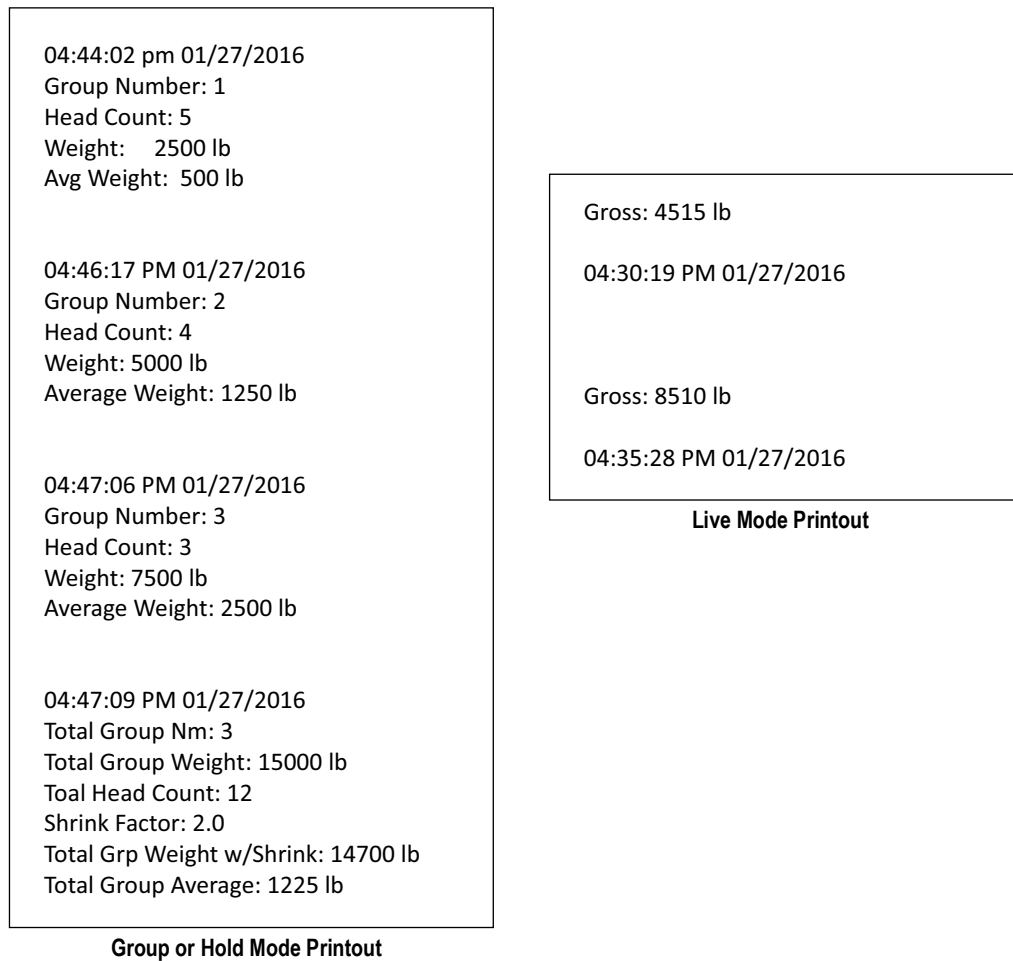



Figure 5-1. Ticket Print Examples

5.2 Live Mode Operation

When live mode is enabled, the indicator always displays the current scale weight. Press  to send the data to the serial port, see [Figure 5-1](#).

5.3 Hold Mode Operation

When hold mode is enabled, the indicator samples the scale for the configured amount of time and then displays and holds the average of the weight sampled.



NOTE: The holding of a display value is signified by the blinking of the current units annunciator. The display hold is released when the weight on the scale drops the hold delta percentage configured (*HDELTA*), the Load Total key is pressed, the indicator is reset or the power is cycled.

5.3.1 Hold Settings

When using the hold mode, the following settings should be set prior to weighing, see [Section on page 27](#).

- Set the *SPTIME* parameter
- Set the *HDELTA* parameter
- Set the *HDTHRSH* parameter









NOTE: If default values of *SPTIME* and *HDELTA* are sufficient, these parameters do not need to be changed.

5.3.2 Weighing Groups in Hold Mode

Multiple groups of animals are weighed. Each group weight is sampled for a set time, and the average weight of the sample time and group data is printed. At the end of all group weighments, the data for all groups (load total) is summarized and printed.

1. Enter the shrink factor on the numeric keypad, if desired, and press , see [Section 1.8.4 on page 12](#).

 **NOTE:** A shrink factor can be entered at any time, but only the last shrink factor entered prior to pressing  will be applied to all of the groups making up the load.

2. Load the first group onto scale.
3. Enter the head count on the numeric key pad, see [Section 1.8.5 on page 13](#).
4. Press . **-SPL-** is displayed for the time the scale is being sampled (**SPTIME**). When sampling is complete, the average group weight is displayed and sent to the serial port. The current units annunciator blinks showing that the display is being held. This weight can be cleared, for example to add additional animals, by pressing . Then repeat step three and enter the new head count.
5. If a reprint of the individual group ticket is required, press  again to resend the current data to the serial port.
6. For each group included in the load, repeat steps two through four.
7. When all groups for a load are complete, press  and the load ticket data will be sent to the serial port, see [Figure 5-1 on page 45](#).

 **NOTE:** There is no reprint ability for the Load Total data

A new load can now be restarted. The group number on the printed ticket increments with each group. Pressing  resets the group number.

 **NOTE:** When the first group of a load is complete, an arrow annunciator, to the left of the zero annunciator, displays to signify the indicator is in the middle of collecting data from groups that make up a load, see [Section 1.6 on page 10](#).

When loading and unloading groups, the power standby mode may engage and power down the indicator. Once the indicator is powered back on, this annunciator signifies that the indicator is still in the middle of collecting load data. The previous group data totals are saved in case of a power down in the middle of collecting load groups.

6.0 EDP Commands



NOTE: EDP commands are case sensitive. Commands must be entered in upper case.

The 482-AG indicator may be controlled by a personal computer, using a terminal emulator program or by a remote keyboard connected to one of the indicators communication ports. Control of the indicator is accomplished through a set of EDP commands that simulate front panel key press functions, display and change configuration parameters and perform reporting functions. This section describes the EDP command set.

6.1 The EDP Command Set

The EDP command set can be divided into five groups: key press commands, reporting commands, the **RESETCONFIGURATION** special function command, parameter setting commands and transmit weight data commands.

When the indicator processes an EDP command, it responds with the message **OK**. The **OK** response verifies that the command was received and has been executed. If the command is unrecognized or cannot be executed, the indicator responds with **??**.

The following sections list the commands and command syntax used for each of these groups.

6.1.1 Key Press Commands

Key press EDP commands simulate pressing the keys on the front panel of the indicator. Most commands can be used in both configuration and weigh mode. Several of the commands serve as pseudo keys, providing functions that are not represented by a key on the front panel.

Command	Function
KZERO	In weigh mode, press the Zero key
KGROSS	Go to gross
KUNITS	In weigh mode, press the Unit key
KPRIM	Go to primary units
KSEC	Go to secondary units
KPRINT	In weigh mode, press the Print key
KMENU	Press the Menu key
KCLRCN	Reset consecutive number
KLEFTARROW	In configuration, move left in the menu
KRIGHTARROW	In configuration, move right in the menu
KUPARROW	In configuration, move up in the menu
KDOWNARROW	In configuration, move down in the menu
KSAVE	In configuration, save the current configuration; command works only if a parameter has been changed
KLOCK	Lock specified front panel key; for example, to lock the Zero key, enter KLOCK=KZERO
KUNLOCK	Unlock specified front panel key; for example, to unlock the Print key, enter KUNLOCK=KPRINT
KCLR	Presses the Clear key
KDATE	Displays the date
KTIME	Displays the time
KTIMEDATE	Displays the time and date

Table 6-1. Key Press EDP Commands

6.1.2 Reporting Commands

Reporting EDP commands send specific information to the selected port. These commands can be used in both configuration and weigh modes.

Command	Function
DUMPALL	List all parameter values
DUMPAUDIT	List audit data information
P	Write current displayed weight with units identifier, see Section 8.2 on page 56 for more information.
ZZ	Write current weight and annunciator status, see Section 8.2 on page 56 for more information.
S	Write one frame of stream format
VERSION	Returns the currently installed firmware version

Table 6-2. Reporting EDP Commands

6.1.3 Special Function Commands

Reset Configuration

The **RESETCONFIGURATION** command can be used to restore all configuration parameters to their default values. Before issuing this command, the indicator must be placed in configuration mode.

This command is equivalent to using the **DEFLT** function on the **TEST** menu, see [Section 3.5 on page 32](#).



NOTE: All load cell calibration settings are lost when the **RESETCONFIGURATION** command is run.

Soft Reset

The command **RS** will reset the indicator without losing configuration and calibration. It does reset consecutive number and count mode.

6.1.4 Parameter Setting Commands

Parameter setting commands allow the operator to display or change the current value for a particular configuration parameter. Current configuration parameter settings can be displayed in either configuration or weigh mode using the following syntax: **command<ENTER>**

Parameter values can be changed only when the indicator is in the configuration mode using the following command syntax: **command=value<ENTER>**, where *value* is either a number or a parameter value.

Use no spaces before or after the equal (=) sign.

If an incorrect command is typed or the indicator is not in the configuration mode, the indicator responds with **??**.

Command	Description	Values
SC.GRADS	Graduations	1–100000
SC.ZTRKBND	Zero track band	0.0–3.0
SC.ZRANGE	Zero range	1–100 Example: to make it 5%, enter in SC.ZRANGE=5 in)
SC.INIZR	Initial zero range	0–100 (if set to zero, no initial zero is performed)
SC.MOTBAND	Motion band	0.0–100 (in display divisions) Example: to enter 5 divisions, send "SC.MOTBAND=5.0"
SC.OVRLOAD	Overload	FS+2%, FS+1D, FS+9D, FS
SC.DSPRAT	Display Rate	0.1 SEC, 0.25 SEC, 0.5 SEC, 0.75 SEC, 1 SEC, NONE
SC.SMPRAT	Sample rate	5HZ, 40HZ, 20HZ, 10HZ
SC.DIGFIL	Select Digital Filter Type	ADAPTIVE, ROLLING, OFF
SC.AFILTER.SENSITIVITY	Adaptive digital filter cutout sensitivity	LIGHT, MEDIUM, HEAVY
SC.AFILTER.THRESHOLD	Adaptive digital filter cutout threshold	0–999999
SC.RFILTER.SENSITIVITY	Digital filter cutout sensitivity	2OUT, 4OUT, 8OUT, 16OUT, 32OUT, 64OUT, 128OUT

Table 6-3. CONFIG EDP Commands

Command	Description	Values
SC.RFILTER.THRESHOLD	Digital filter cutout threshold	NONE, 2DD, 5DD, 10DD, 20DD, 50DD, 100DD, 200DD, 250DD
SC.RFILTER.STAGE1-3	Digital filtering	1, 2, 4, 8, 16, 32, 64
SC.DSPMOD	Display mode	GROUP, LIVE, HOLD
SC.WGDELTA	Weight Delta (in group mode)	00-99%
SC.SPTIME	Display mode sampling time (in hold mode)	1-10 seconds
SC.HDELTA	Hold Delta (in hold mode)	00-99%
SC.HDTHRS	Hold Delta Threshold (in hold mode)	0000 - 9999

Table 6-3. CONFIG EDP Commands (Continued)

Command	Description	Values
SC.PRI.DECPNT	Primary units decimal position	8.88888, 88.8888, 888.888, 8888.88, 88888.8, 888888
SC.PRI.DSPDIV	Primary units display divisions	1D, 2D, 5D, 10D, 20D, 50D
SC.PRI.UNITS	Primary units	LB, KG, OZ, TN, T, G
SC.SEC.DECPNT	Secondary units decimal position	8.88888, 88.8888, 888.888, 8888.88, 88888.8, 888888
SC.SEC.DSPDIV	Secondary units display divisions	1D, 2D, 5D, 10D, 20D, 50D
SC.SEC.UNITS	Secondary units	LB, KG, OZ, TN, T, G

Table 6-4. FORMAT EDP Commands

Command	Description	Values
SC.WZERO	Zero calibration**	—
SC.WVAL	Test weight value	value
SC.WSPAN	Span calibration**	—
SC.REZERO	Rezero	—
SC.LC.CD	Read or set dead load counts	value
SC.LC.CW	Read or set span counts	value

** The indicator must be in configuration mode prior to sending the SC.WZERO or SC.WSPAN commands

Table 6-5. CALIBR EDP Commands

Command	Description	Values
PWRUPMD	Power up	GO, DELAY
REGULAT	Regulatory compliance	NTEP, OIML, CANADA, NONE
CONSNUM	Consecutive number	0 – 999999
CONSTUP	Consecutive number start-up value	0 – 999999
DATEFMT	Date format	MMDDYY, DDMMYY, YYMMDD, YYDDMM
DATESEP	Date separator	SLASH, DASH, SEMI
TIMEFMT	Time format	12HOUR, 24HOUR
TIMESEP	Time separator	COLON, COMMA
UID	Unit ID Value	0 – 999999
POWER	Power switch	AUTO, MANUAL
SLEEP	Sleep setting	NEVER, 1, 2, 5, 10
STDBY	Standby setting	OFF, 1SEC, 2SEC, 3SEC, 5SEC, 10SEC, 60SEC
WGTHRH	Sleep Mode Weight Threshold	0-999999
DDTHRH	Sleep Mode Display Division Threshold	0-999999

Table 6-6. PROGRM EDP Commands

Command (p = Port No.)	Description	Values
EDP.TRIGGER#p	EDP port trigger	Port 1 – COMAND, DEMAND, PRN, NONE Port 2 – NONE, PRN, STR-1, STR-2, STR-3, STR-4, STR5
EDP.BAUD#p	EDP port baud rate	1200, 2400, 4800, 9600, 19200, 38400
EDP.BITS#p	EDP port data bits/parity	8NONE, 7EVEN, 7ODD
EDP.SBITS#p	EDP port stop bits	1STOP, 2STOP
EDP.TERMIN#p	EDP port termination character	CR/LF, CR
EDP.EOLDLY#p	EDP port end-of-line delay	0 – 255 (0.1-second intervals)
EDP.ECHO#p	EDP port echo	ON, OFF
EDP.PRNMSG#p	Enable print message when a demand print is performed	OFF, ON
EDP.STRUR#2	Legal for Trade or industrial stream	STRLFT,STRIND
EDP.STREAM	Specifies the operating of the indicator, see Section 3.6.2 on page 34	NONE, LOCAL, REMOTE

Table 6-7. SERIAL EDP Commands

Command	Description	Default Values
GFMT	Gross demand print format string	GROSS<G><NL2><TD><NL>
GWFM	Group Weight format string	<NL2><TD><NL>Group Number:<GN><NL>Head Count:<HC><NL>Weight:<GW><NL>Average Weight:<AG><NL>
LTFMT	Load Total format string	<NL2><TD><NL>Total Group Nm:<TGN><NL>Total Group Weight:<TGW><NL>Total Head Count:<THC><NL>Shrink Factor:<SF><NL>Total Group Weight w/ Shrink:<TGWS><NL>Total Group Average:<TGA><NL>

Table 6-8. PFRMAT EDP Commands

Command	Description	Values
POWER	Determines if indicator automatically powers on when plugged in or if power key must be pressed. Read only in weigh mode.	AUTO MANUAL
BKLGHT	Controls the LCD backlight display. Read only in weigh mode.	ON, OFF, AUTO
BKLGHT.AUTO	Controls the LCD backlight display auto off time. Read only in weigh mode.	10SEC, 30SEC, 1MIN, 5MIN, 10MIN
BAT	Reads the battery level. Read only.	Current battery level in millivolts.

Table 6-9. MISC Commands

6.1.5 Weigh Mode Commands

The serial transmit weight data commands in [Table 6-10](#) transmit data to the selected port on demand. The **SX** and **EX** commands are valid only in the weigh mode; all other commands are valid in either configuration or weigh modes.

Command	Description	Response Format
UID	View and set unit ID when in configuration In weigh mode, the value can be changed temporarily; it will revert to last saved value at next power up	nnnnnn
DATESET	View or set date	The response will be in the format, and using the separators, as defined in configuration; to set, first query the date, then send DATESET= , in exactly the same format (use only two digits for the year)
TIMESSET	View or set time	The response will be in the format, and using the separators, as defined in configuration; to set, first query the time, then send TIMESSET= followed by the time in exactly the same format as the query, including seconds, and AM or PM if in 12 hour format
SX	Start streaming on Port 2. NOTE: The trigger mode of Port 2 must be set to one of the five stream s for this command to function.	OK or ??
EX	Stop streaming on Port 2 NOTE: The trigger mode of Port 2 must be set to one of the five stream s for this command to function.	OK or ??
RS	Soft reboot	See Section 6.1.3 on page 48
XG	Transmit gross weight in displayed units	nnnnnn UU
XG2	Transmit gross weight in non-displayed units	Where nnnnnn is the weight value, UU is the units
XE	Query system error conditions	nnnnn nnnnn See Section 8.1 on page 54 for detailed information about the XE command response format

Table 6-10. Weigh Mode EDP Commands

7.0 Print Formatting

The 482-AG provides print format to determine the information to be printed on a ticket.

Each print format can be customized to include up to 300 characters of information, such as company name and address, on printed tickets. The indicator front panel (**PFRMAT** menu) can be used to customize the print formats, see [Section 3.6.4 on page 40](#).



NOTE: The display will only show capital letters. Press the down arrow to view the ASCII character decimal value on the second menu level. Refer to [Table 8-3 on page 56](#) and [Table 8-4 on page 57](#) to view the ASCII character charts.

7.1 Print Formatting Tokens

[Table 7-1](#) lists tokens that can be used to configure the print formats. Tokens included in the format strings must be enclosed between < and > delimiters. Any characters outside of the delimiters are printed as text on the ticket. Text characters can include any ASCII character that can be printed by the output device. The default 482-AG print formats are shown.

Token	Description
<G>	Gross weight in displayed units
<G2>	Gross weight in non-displayed units ***
<UID>	Unit ID number
<CN>	Consecutive number
<NLnn>	New line (nn = number of termination (<CR/LF> or <CR>) characters)*
<SPnn>	Space (nn = number of spaces)*
<SU>	Toggle weight data format (formatted/unformatted) ** ***
<TI>	Time
<DA>	Date (prints 4 digit year)
<TD>	Time & Date
<GN>	Group number
<HC>	Head count
<AG>	Average weight
<TGN>	Total group number
<TGW>	Total group weight
<THC>	Total head count
<SF>	Shrink factor
<TGWS>	Total group weight with shrink
<TGA>	Total group average
Gross weight is nine digits in length, including sign, 10 digits with decimal point, followed by a space and a two-digit units identifier; The total field length with units identifier is 12 (or 13) characters	
UID and consecutive number (CN) fields are six characters in length	
* If nn is not specified, 1 is assumed; Value must be in the range 1–99	
** After receiving an SU command, the indicator sends unformatted data until the next SU command is received; Unformatted data omits decimal points, and leading and trailing characters	
*** Not available if regulatory mode is set to OIML	

Table 7-1. Print Format Tokens



NOTE: The <G2> token within [Table 7-1](#) prints the gross weight in the units not currently displayed on the indicator.

The 300 character limit of each print format string includes the output field length of the print formatting tokens, not the token length. For example, if the indicator is configured to show a decimal point, the <G> token generates an output field of 13 characters: the 10 character weight value (including decimal point), one space, and a two-digit units identifier.

7.1.1 Print Defaults

Port 1 is the default for printing; however, Port 2 can also be used, if not in use for streaming, see [Table 3-13 on page 35](#) and [Table 3-14 on page 36](#).

The 482-AG typically prints to an Epson TM-U295 Ticket Printer. For testing purposes, send the print information to a terminal emulation program, for example, HyperTerminal.

Parameter	Port 1	Port 2
TRIGGER	Demand	PRN
Baud	9600	9600
BITS	8N	8N
SBITS	1Stop	1Stop
TERMIN	CR-LF	CR-LF
EOLDLY	000	000
ECHO	ON	OFF
PRNMSG	OFF	OFF
STUR	—	STR LFT (default) STR IND

Table 7-2. Test Print Setup

7.2 Customizing Print Formats

The print format (**PFRMAT**) menu can be used to customize the **GFMT**, **GWGMT**, **LTFMT** formats using the front panel (**PFRMAT** menu), see [Figure 3-15 on page 40](#) for print format menu structure.

The print format strings may be edited by changing the decimal values of the ASCII characters in the format string.



NOTE: Some characters cannot be displayed on the 482-AG front panel and are shown as blanks. See the ASCII Character Charts in [Table 8-3 on page 56](#) and [Table 8-4 on page 57](#). The 482-AG can send or receive any ASCII character; the character printed depends on the particular ASCII character set implemented for the receiving device.

8.0 Maintenance and Troubleshooting

8.1 Error Messages

Error message can be viewed on the indicator front panel or from a remote location by using EDP commands.

8.1.1 Displayed Error Messages

The 482-AG provides a number of front panel error messages to assist in problem diagnosis. [Table 8-1](#) lists these messages and their meanings.

Error Messages	Description	Solution
E A/D	A/D physical error	Call Rice Lake Weighing Systems Service at 800-472-6703
EEEROM	EEPROM physical error	
EVIREE	Virgin EEPROM	Use TEST menu to perform DEFLT (restore defaults) procedure then recalibrate load cells
EPCKSM	Parameter checksum error	
EACKSM	A/D calibration checksum error	A/D converter requires recalibration. Call Rice Lake Weighing Systems Service
EFCKSM	Printer format checksum error	Call Rice Lake Weighing Systems Service at 800-472-6703
ELCKSM	Load cell calibration checksum error	Recalibrate load cells
EIDATA	Internal RAM checksum error	Call Rice Lake Weighing Systems Service at 800-472-6703
E REF	A/D reference error	A/D converter requires recalibration; call Rice Lake Weighing Systems Service
ERROR	Internal program error	Check configuration; call Rice Lake Weighing Systems Service if unable to clear error by cycling power or if error recurs
OVERFL	Overflow error	Weight value is too large to be displayed
=====	Gross > overload limit	Gross value exceeds overload limit; check configuration or signal input level; overload can be caused by input signal > 45 mV or common mode voltage > 950 mV
-----	Gross < 20d behind zero	Gross value is more than 20 divisions behind zero (OIML)
RNGERR	GRADS > 100,000 WVAL > 100,000	Only displays in configuration mode
EEPERR	EEPROM error	Call Rice Lake Weighing Systems for service at 800-472-6703
HINOFF	High offset	Zero load at startup is more than initial zero range (INIZR) setting of calibration zero—remove the extra load
LINOFF	Low offset	Zero load at startup is less than initial zero range (INIZR) setting of calibration zero—add the missing load
NOBATT	No battery	The RTC lost time/date tracking at previous power off state due to low battery or no battery condition; the printer, accumulator and audit functions will fail to get time and date NOTE: Refers to internal coin battery only, not the rechargeable battery option.
EPCKSM	Configuration checksum	The checksum value of configuration has changed from that stored in memory; Enter into the Config menu, then back out; The indicator display Saving; If this does not clear the error, enter the configuration menu, navigate to the Test Menu and navigate to Default; Press enter and the indicator will be reset to default settings
OIMLER	OIML parameter error	Parameter set incorrectly for use in the OIML mode; Check configuration and change as necessary <i>Example: Primary units set for lb or oz</i>
EE-ACC	Accumulator error	Error with the accumulator such as attempting to display an accumulated value greater than six digits

Table 8-1. 482 Error Messages



NOTE: Shorting excitation voltage shuts excitation voltage off. The only way to restore excitation voltage is to cycle power.

8.1.2 Using the XE EDP Command

The XE EDP command can be used to remotely query the 482-AG for the error conditions displayed on the front panel.

The XE command returns two five digit numbers in the format: **xxxxx yyyyy**

Where **xxxxx** contains a decimal representation of an existing error conditions as described in [Table 8-2](#).

*If more than one error condition exists, the number returned is the sum of the values representing the error conditions. For example, if the **XE** command returns the number 1040, this value represents the sum of an A/D reference error (1024) and an A/D calibration checksum error (16).*

The second number returned (**yyyyy**) uses bit assignments to indicate whether the test for the error condition is run, see [Table 8-2](#) for error condition information.

*Example: the value **yyyyy** = 50815 represents the decimal equivalent of the binary value 1100 0110 0111 1111. Using the bit assignments in [Table 8-2](#), this value indicates all tests were run.*

Error Code	Description	Binary Value
1	EEPROM Error	0000 0000 0000 0001
2	Virgin EEPROM	0000 0000 0000 0010
4	Config Parameter Checksum	0000 0000 0000 0100
8	Load Cell Checksum	0000 0000 0000 1000
16	A/D Calibration Checksum	0000 0000 0001 0000
32	Print Formats Checksum	0000 0000 0010 0000
64	XA Internal RAM Error	0000 0000 0100 0000
128	External RAM Error	0000 0000 1000 0000
256	Reserved	0000 0001 0000 0000
512	ADC Physical Error	0000 0010 0000 0000
1024	ADC Reference	0000 0100 0000 0000
2048	Count Error	0000 1000 0000 0000
4096	Reserved	0001 0000 0000 0000
8192	Display Range	0010 0000 0000 0000
16384	ADC Range	0100 0000 0000 0000
32768	Gross Limit	1000 0000 0000 0000
0x10000 - 0x80000000		Reserved

Table 8-2. Error Codes Returned on XE Command

8.2 ASCII Character Chart

Use the decimal values for ASCII characters listed in [Table 8-3 on page 56](#) and [Table 8-4 on page 57](#) when specifying print format strings on the 482-AG PFORMT menu. The actual character printed depends on the character mapping used by the output device.

The 482-AG can send or receive a ASCII character value (decimal 0–255), but the indicator display is limited to numbers, upper-case, unaccented letters and a few special characters, see [Section 8.3 on page 58](#) for information about the 482-AG LCD display.

Control	ASCII	Dec	Hex	ASCII	Dec	Hex	ASCII	Dec	Hex	ASCII	Dec	Hex
Ctrl-@	NUL	00	00	space	32	20	@	64	40	`	96	60
Ctrl-A	SOH	01	01	!	33	21	A	65	41	a	97	61
Ctrl-B	STX	02	02	"	34	22	B	66	42	b	98	62
Ctrl-C	ETX	03	03	#	35	23	C	67	43	c	99	63
Ctrl-D	EOT	04	04	\$	36	24	D	68	44	d	100	64
Ctrl-E	ENQ	05	05	%	37	25	E	69	45	e	101	65
Ctrl-F	ACK	06	06	&	38	26	F	70	46	f	102	66
Ctrl-G	BEL	07	07	'	39	27	G	71	47	g	103	67
Ctrl-H	BS	08	08	(40	28	H	72	48	h	104	68
Ctrl-I	HT	09	09)	41	29	I	73	49	i	105	69
Ctrl-J	LF	10	0A	*	42	2A	J	74	4A	j	106	6A
Ctrl-K	VT	11	0B	+	43	2B	K	75	4B	k	107	6B
Ctrl-L	FF	12	0C	,	44	2C	L	76	4C	l	108	6C
Ctrl-M	CR	13	0D	-	45	2D	M	77	4D	m	109	6D
Ctrl-N	SO	14	0E	.	46	2E	N	78	4E	n	110	6E
Ctrl-O	SI	15	0F	/	47	2F	O	79	4F	o	111	6F
Ctrl-P	DLE	16	10	0	48	30	P	80	50	p	112	70
Ctrl-Q	DC1	17	11	1	49	31	Q	81	51	q	113	71
Ctrl-R	DC2	18	12	2	50	32	R	82	52	r	114	72
Ctrl-S	DC3	19	13	3	51	33	S	83	53	s	115	73
Ctrl-T	DC4	20	14	4	52	34	T	84	54	t	116	74
Ctrl-U	NAK	21	15	5	53	35	U	85	55	u	117	75
Ctrl-V	SYN	22	16	6	54	36	V	86	56	v	118	76
Ctrl-W	ETB	23	17	7	55	37	W	87	57	w	119	77
Ctrl-X	CAN	24	18	8	56	38	X	88	58	x	120	78
Ctrl-Y	EM	25	19	9	57	39	Y	89	59	y	121	79
Ctrl-Z	SUB	26	1A	:	58	3A	Z	90	5A	z	122	7A
Ctrl-[ESC	27	1B	;	59	3B	[91	5B	{	123	7B
Ctrl-\	FS	28	1C	<	60	3C	\	92	5C		124	7C
Ctrl-]	GS	29	1D	=	61	3D]	93	5D	}	125	7D
Ctrl-^	RS	30	1E	>	62	3E	^	94	5E	~	126	7E
Ctrl-_"	US	31	1F	?	63	3F	_	95	5F	DEL	127	7F

Table 8-3. ASCII Character Chart (Part 1)

ASCII	Dec	Hex	ASCII	Dec	Hex	ASCII	Dec	Hex	ASCII	Dec	Hex
Ç	128	80	á	160	A0	--	192	C0	α	224	E0
ü	129	81	í	161	A1	--	193	C1	β	225	E1
é	130	82	ó	162	A2	--	194	C2	Γ	226	E2
â	131	83	ú	163	A3	--	195	C3	π	227	E3
ä	132	84	ñ	164	A4	--	196	C4	Σ	228	E4
à	133	85	Ñ	165	A5	--	197	C5	σ	229	E5
â	134	86	ª	166	A6	--	198	C6	μ	230	E6
ç	135	87	º	167	A7	--	199	C7	τ	231	E7
ê	136	88	¿	168	A8	--	200	C8	Φ	232	E8
ë	137	89		169	A9	--	201	C9	Θ	233	E9
è	138	8A	¬	170	AA	--	202	CA	Ω	234	EA
ï	139	8B	½	171	AB	--	203	CB	δ	235	EB
î	140	8C	¼	172	AC	--	204	CC	∞	236	EC
ì	141	8D	¡	173	AD	--	205	CD	φ	237	ED
Ä	142	8E	«	174	AE	--	206	CE	€	238	EE
Å	143	8F	»	175	AF	--	207	CF	∩	239	EF
É	144	90	--	176	B0	--	208	D0	≡	240	F0
æ	145	91	--	177	B1	--	209	D1	±	241	F1
Æ	146	92	--	178	B2	--	210	D2	≥	242	F2
ô	147	93	--	179	B3	--	211	D3	≤	243	F3
ö	148	94	--	180	B4	--	212	D4	∫	244	F4
ò	149	95	--	181	B5	--	213	D5	∫	245	F5
û	150	96	--	182	B6	--	214	D6	÷	246	F6
ù	151	97	--	183	B7	--	215	D7	≈	247	F7
ÿ	152	98	--	184	B8	--	216	D8	°	248	F8
Ö	153	99	--	185	B9	--	217	D9	•	249	F9
Ü	154	9A	--	186	BA	--	218	DA	--	250	FA
ç	155	9B	--	187	BB	--	219	DB	--	251	FB
£	156	9C	--	188	BC	--	220	DC	--	252	FC
¥	157	9D	--	189	BD	--	221	DD	²	253	FD
Pts	158	9E	--	190	BE	--	222	DE	--	254	FE
f	159	9F	--	191	BF	--	223	DF	--	255	FF

Table 8-4. ASCII Character Chart (Part 2)

8.3 Front Panel Display Characters

Figure 8-1 provides the seven-segment LCD character set used to display alphanumeric characters on the 482-AG front panel.

	-	9	E	Q
	.	:	F	R
	/	;	G	S
	0	<	H	T
%	1	=	I	U
&	2	>	J	V
,	3	?	K	W
(4	@	L	X
)	5	A	M	Y
*	6	B	N	Z
+	7	C	O	[
,	8	D	P	\

Figure 8-1. Display Characters

9.0 Specifications

Model Numbers

United States	482-2A/482 Plus-2A (NEMA Type 5-15)
International	482-2A/482 Plus-2A (CEE 7/7)

Power – AC

Line Voltages	115–230 VAC
Frequency	50 or 60 Hz
Power Consumption	70 mA @ 115 VAC (8 Ω) 35 mA @ 230 VAC (8 Ω)
Fusing	2.5 A 5 x 20 mm fuse

Power – Battery (Optional Internal Battery)

Battery Type	Rechargeable Lithium-Ion
Nominal Voltage	3.65 V
Nominal Capacity	5300 mAh
Estimated Battery Life	40 hours (350 W load without backlight) 15 hours (350 W load with backlight)
Approx. Charge Time	16 hours to achieve 100%

Analog Specifications

Full Scale Input Signal	Up to 35 mV
Excitation Voltage	5 \pm 0.1 VDC
Sense Amplifier	Differential amplifier with Four- and Six-wire sensing
Analog Signal Input Range	Up to 7 mV/V
Analog Signal Sensitivity	0.1 μ V/graduation minimum 0.5 μ V/grad recommended
Local Resistance	35–1140 Ω
Noise (ref to input)	0.5 μ V p-p
Internal Resolution	523,376 counts
Display Resolution	100,000 dd
Measurement Rate	37 measurements/sec
Input Sensitivity	38 nV per internal count
System Linearity	Within 0.01% of full scale
Zero Stability	13 nV/ $^{\circ}$ C ⁴
Span Stability	13 ppm/ $^{\circ}$ C ⁵
Calibration Method	Software, constants stored in EEPROM
Common Mode	
Voltage	AGND + 250 mV V min Excitation - 250 mV V max
Rejection	120 dB minimum @ 50 or 60 Hz
Normal Mode Rejection	100 dB minimum @ 50 or 60 Hz
Input Overload	-0.3 V–(Excitation)+0.3 V
RFI Protection	Signal, excitation, and sense lines protected by capacitor bypass and ESD suppressors

Digital Specifications

Microprocessor	ARM Cortex M3 STM32F103ZET6
Digital Filters	Adaptive Filter and Rolling Averaging Filter; software selectable

Serial Communications

Com 1	Full duplex RS-232
Com 2	Full duplex RS-232, or output only Active 20mA current loop
Both Ports	1200–38400 bps; seven or eight data bits; even, odd, or no parity; one or two stop bits

Operator Interface

Display	Six-digit LCD display, 7-segment, 0.8 in (20 mm) digits
Annunciators	lb, kg, g, oz, t, center of zero, standstill, transaction in progress
Keypad	Flat membrane panel, embossed keys, tactile feel

Environmental

Operating Temperature	-10±40°C (legal) -10±50°C (industrial)
Storage Temperature	-25±70°C
Humidity	0–95% relative humidity

Enclosure

Enclosure Dimensions	9.5 in x 6 in x 2.75 in 24 cm x 15 cm x 7 cm
Weight	6 lb
Rating/Material	4X

Certifications and Approvals**NTEP**

CoC Number 12-123
Accuracy Class III/IIIL n_{max} : 10 000

**OIML R76/2006-NL1-15.24**

European Test Certificate TC8322
Accuracy Class III n_{max} : 10 000

**Measurement Canada**

Approval AM-5892
Accuracy Class III/II/HD n_{max} : 10 000

**UL**

File Number: 151461

**FCC**

The 480 complies with Part 15 of the FCC Rules. Operation is subject to the following conditions:

- This device may not cause harmful interference.
- This device must accept any interference received, including interference that may cause undesired operation.



© Rice Lake Weighing Systems Content subject to change without notice.

230 W. Coleman St. • Rice Lake, WI 54868 • USA USA: 800-472-6703 • International: +1-715-234-9171