

Hardware and Accessories

TABLE OF CONTENTS

Load Cell Mounting Hardware Safety Guidelines.....	424	Summit® 3000 Scale Base	438	Mechanical Scale Tickets	450
Mounting Assembly Component Identification.....	425	Floor Scale Base	438	<i>Create Your Own Custom Ticket</i>	
Jam Nuts	425	Complete Custom Cable Services	439	Printer Dust Covers.....	450
Eye Nuts.....	426	EL147, 6 Wire	440	Printer Cables.....	451
Clevis Mount Assemblies	426	<i>Standard Load Cell Cable</i>		Static Brushes.....	452
Coupling Nuts	426	EL147RP Plus, 6 Wire	440	Ionizing Strips.....	452
Load Cell Eye Bolts	427	<i>Rodent Protection Load Cell Cable</i>		Desiccants	452
Rod End Ball Joints.....	428	EL147HE, 6 Wire	441	Crimper and Lead Seals.....	452
Connecting Links.....	428	<i>Hostile Environment Load Cell Cable</i>		Ionizing Strip Accessories	452
Load Cell Isolators.....	429	EL147IS, 6 Wire.....	441	Industrial Corrosion Inhibitor.....	452
Threaded Adapters.....	429	<i>Hazardous Environment Blue Jacket Load Cell Cable</i>		Static Control Table Mat and Floor Mat	453
ITCM Hardware Kits.....	430	EL146, 4 Wire	442	Static Control Wrist Strap.....	453
Grounding Strap.....	431	<i>Standard Load Cell Cable</i>		Static Shielding Bags	453
Ball Bearings.....	431	EL146HE, 4 Wire	442	Static-Safe Service Kit.....	453
Load Receiver Plate.....	431	<i>Hostile Environment Load Cell Cable</i>		Rice Lake's Scale Technician Kits.....	454
Load Cups.....	431	Fiber-Optic Cable.....	443		
Wire Rope Assemblies	432	EL144 Communications Cable	443		
Cardinal® Wire Rope Assemblies	432	BCD Cable	443		
Custom Wire Ropes	432	SURVIVOR® EL620HE	444		
Custom Wire Rope Definition Form.....	433	<i>High Temperature Cable</i>			
Spherical Washer Sets.....	434	EL148HE Mettler Toledo®	444		
Load Cell Spacers.....	434	<i>Replacement Power Cell Cable</i>			
Load Button.....	434	Mettler Toledo® Power Cell®	444		
Weldless End Links.....	434	<i>Homerun Cable</i>			
Load Button Insert Kit	435	SURVIVOR® Cable Armor	444		
Flintec® Adjustable Rubber Foot	435	Cord Grip Assemblies	445		
Bench Scale Feet	435	EL214 Cable Splicing Kit.....	445		
Surefoot®	435	Load Cell Conduit Adapters	445		
Polyurethane Rubber Leveling Feet.....	436	EL214T Cable Splicing Kit	446		
Captured Ball Floor Scale Leveling Feet.....	436	EL215 Cable Splicing Kit.....	446		
Leveling Mount.....	437	Flintec™ Load Cell Cable	446		
Leveling Pads.....	437	<i>Replacement Kits</i>			
Leveling Pad Stems	437	Five-Position Connectors, Shell Plugs, Receptacles	447		
RoughDeck® Scale Base	438	Seven-Position Connectors, Shell Plugs, Receptacles	447		
		Six-Position Connectors, Shell Plugs, Receptacles.....	447		
		T-Grip Molding	448		
		T-Strip Molding	448		
		Electronic Scale Tickets.....	449		

The following product names, logos, brands and other trademarks featured or referred to within this publication are the property of their respective trademark holders.

Load Cell Mounting Hardware Safety Guidelines

Install only load cell mounting hardware and assemblies that have been specifically designed for use in tank, hopper or hanging scale applications. Often, the use of an inferior-grade product results in component failure which risks equipment damage and personal injury. These simple suggestions are provided to help minimize your exposure to vessel scale installation hazards.

1. Estimating Gross Load

To select the correct load cell or load cell hardware for a given application, it is necessary to know the total weight on the scale—including net weight of product, tare weight of the vessel and weight of the platform, tank or hopper, as appropriate.

2. Safe Load

Do not exceed safe load figures listed in Rice Lake Weighing Systems' catalog for any load cell hardware. Where shock loads are present, it may be necessary to derate these safe load figures depending on severity of the shock load.

3. Load Distribution

In multiple-load-cell applications, weight must be evenly distributed between all cells.

4. Threaded Connections

Check that all threads of a threaded connection are in engagement. For example, an eye bolt screwed into an s-type load cell should protrude slightly on the opposite side.

5. Jam Nuts

All threaded connections must be locked with jam nuts to prevent inadvertent disassembly. If a load is suspended from a single load cell, it is critical that the load cannot rotate as this may loosen the jam nut.

6. Wire Rope Assemblies

With wire rope assemblies, do not twist the rope during assembly or disassembly. For example, do not remove a frozen nut from one end of a rope assembly by holding the opposite end.

7. Attachment Points of a Load Cell Hardware Assembly

The attachment points of a load cell hardware assembly must be aligned properly and the assembly should be essentially vertical.

8. Swaying in a Suspended Vessel Scale

If there is excessive swaying in a suspended vessel scale, apply horizontal checking to reduce amplitude.

9. Safety Backup

If failure of one or more load cell hardware assemblies could cause injury or damage, a safety backup (safety chains, safety rods, etc.) must be used. The assemblies should be inspected routinely for damage, excessive wear or corrosion and replaced if necessary.

10. Hopper Scales: Guarding Against Contamination

With hopper scales, guard against contamination of the product being weighed in case of failure of the load cell or hardware assembly. For example, do not locate a wire rope assembly over a hopper scale where broken strands of wire could fall into the weighing vessel, contaminating the product being weighed.

11. Selecting Steel Rod or Any Other Weight-Bearing Components

Select steel rod or any other weight-bearing components so the minimum tensile strength is at least four times the total weight carried by that component. Note that threaded rod is generally made from a low tensile-strength mild steel which should be checked for tensile strength before use in any suspended vessel scale.

Mounting Assembly Component Identification

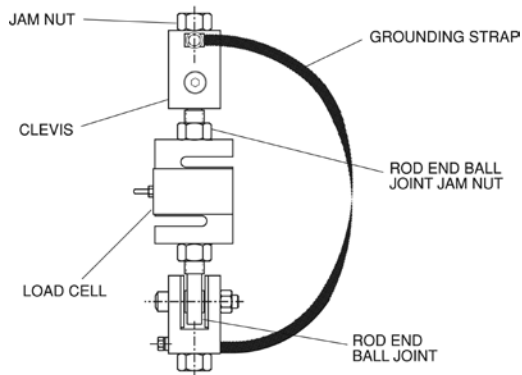

ITCM Isolated Tension Cell Mounting Assembly

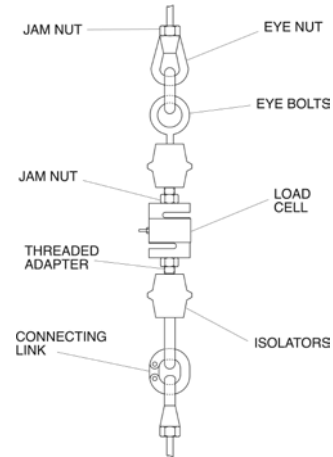

Conventional Tension Mounting Assembly

Our popular Isolated Tension Cell Mounting (ITCM) assembly and other conventional suspended weighing system assemblies employ a variety of serviceable hardware components. Rice Lake Weighing Systems offers a comprehensive selection of these items for all of your suspended vessel service needs. These drawings are designed to enable you to quickly identify and differentiate components from both of these common designs. All corresponding replacement hardware is located on the following pages.

Jam Nuts



Standard Features

- Mild steel/stainless steel
- Coarse or fine thread
- Zinc-plated mild steel or stainless steel

Thread Size	Part #	Price
Mild Steel, Fine Thread		
1/4-28 UNF	14639	\$1.00
3/8-24 UNF	14651	\$1.00
1/2-20 UNF	14664	\$1.60
3/4-16 UNF	14687	\$1.60
1-12 UNF	14702	\$5.99
1-14 UNF	14703	\$4.90
1 1/4-12 UNF	14708	\$3.60
1 1/2-12 UNF	14711	\$4.90
Mild Steel, Coarse Thread		
1/4-20 UNC	14636	\$1.00
3/8-16 UNC	14649	\$2.25
1/2-13 UNC	14661	\$1.00
5/8-11 UNC	14676	\$2.25
3/4-10 UNC	14686	\$1.06
1-8 UNC	14701	\$1.20
1-1/4-7 UNC	14707	\$3.30

Thread Size	Part #	Price
Stainless Steel, Fine Thread		
1/4-28 UNF	14640	\$1.30
1/2-20 UNF	14665	\$1.80
3/4-16 UNF	14688	\$2.30
Stainless Steel, Coarse Thread		
3/8-16 UNC	14653	\$2.10
1/2-13 UNC	14662	\$1.85
5/8-11 UNC	14680	\$2.10
3/4-10 UNC	14690	\$2.25

HARDWARE AND ACCESSORIES

Eye Nuts

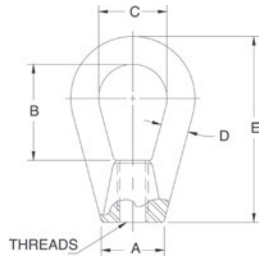

Standard Features

- Drop-forged steel, tapped NC right-hand threads

Part Number/Price

Part #	A	B	C	D	E	Thread Size	Safe Load*	Price
17772	0.50 in	1.06 in	0.75 in	0.25 in	1.68 in	1/4-20 UNC	500 lb	\$48.00
17773	0.75 in	1.18 in	0.87 in	0.31 in	2.25 in	3/8-16 UNC	1,800 lb	\$32.00
17774	1.00 in	1.56 in	1.12 in	0.43 in	3.00 in	1/2-13 UNC	3,600 lb	\$48.00
17775	1.25 in	1.93 in	1.37 in	0.56 in	3.75 in	5/8-11 UNC	5,800 lb	\$53.00

*Do not exceed the safe load

Coupling Nuts



Standard Features

- Heavy hex

Part Number/Price

Part #	Thread Size	Length	Flat	Safe Load*	Price
14638	1/4-20 UNC	1.75 in	0.44 in	500 lb	\$7.50
14650	3/8-16 UNC	1.75 in	0.62 in	1,500 lb	\$7.40
14663	1/2-13 UNC	1.75 in	0.87 in	3,000 lb	\$7.40
14681	5/8-11 UNC	2.12 in	1.06 in	7,500 lb	\$10.50
14691	3/4-10 UNC	2.25 in	1.25 in	10,000 lb	\$11.50

*Do not exceed the safe load

Clevis Mount Assemblies



Standard Features

- Mild steel
- Assembly used in the ITCM
- Adapts rod to rod-end ball joint
- Provides electrical isolation for load cell protection
- Elimination of unwanted side loads
- Optional stainless steel provides enhanced corrosion resistance

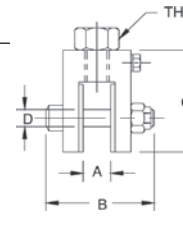

Clevis Mount with bolt

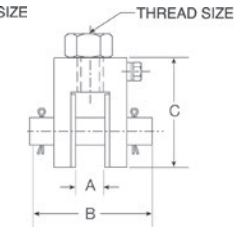

Clevis Mount with pin

Part Number/Price

Part #	A	B	C	D	Thread Size	Safe Load*	Price
Mild Steel with Bolt							
17792	0.52 in	2.38 in	1.94 in	0.38 in	3/8-16 UNC	300 lb	\$87.00
17793	0.52 in	2.38 in	1.94 in	0.38 in	1/2-13 UNC	300 lb	\$87.00
17783	0.39 in	1.81 in	1.69 in	0.25 in	1/2-13 UNC	500 lb	\$99.00
17784	0.65 in	2.68 in	2.31 in	0.50 in	3/4-10 UNC	4,000 lb	\$99.00
17785	0.78 in	3.37 in	3.00 in	0.62 in	1-8 UNC	10,000 lb	\$99.00
17786	0.39 in	1.81 in	1.69 in	0.25 in	3/8-16 UNC	500 lb	\$94.00
17787	0.65 in	2.68 in	2.31 in	0.50 in	1/2-13 UNC	2,000 lb	\$99.00
17788	0.65 in	2.68 in	2.31 in	0.50 in	5/8-11 UNC	2,500 lb	\$99.00
17789	0.78 in	3.37 in	3.00 in	0.62 in	3/4-10 UNC	5,000 lb	\$99.00
Mild Steel with Pin							
17790	1.39 in	4.12 in	4.50 in	1.00 in	1 1/4-7 UNC	15,000 lb	\$367.00
17791	1.22 in	4.12 in	5.00 in	1.25 in	1 1/2-6 UNC	20,000 lb	\$367.00
Stainless Steel with Pin							
33644	0.52 in	2.38 in	1.94 in	0.38 in	1/2-13 UNC	300 lb	\$192.00
33643	0.39 in	1.81 in	1.69 in	0.25 in	1/2-13 UNC	500 lb	\$192.00
33641	0.39 in	1.81 in	1.69 in	0.25 in	3/8-16 UNC	500 lb	\$192.00
33658	0.52 in	2.38 in	1.94 in	0.38 in	3/8-16 UNC	500 lb	\$192.00
33642	0.65 in	2.68 in	2.31 in	0.50 in	3/4-10 UNC	4,000 lb	\$250.00
33640	0.65 in	2.68 in	2.31 in	0.50 in	1/2-13 UNC	2,000 lb	\$250.00
33639	0.65 in	2.68 in	2.31 in	0.50 in	5/8-11 UNC	2,500 lb	\$250.00
33638	0.78 in	3.37 in	3.00 in	0.62 in	3/4-10 UNC	5,000 lb	\$250.00

*Do not exceed the safe load

Load Cell Eye Bolts

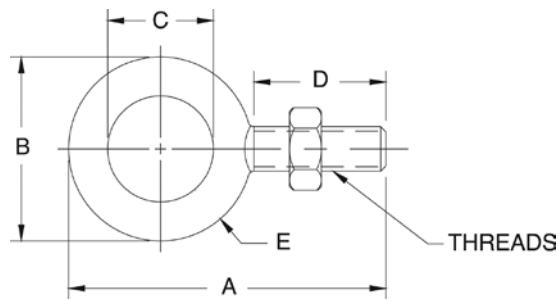

Standard Features

- Mild steel
- One jam nut included with each eye bolt

Part Number/Price

Part #	A	B	C	D	E	Thread Size	Safe Load*	Price
Mild Steel								
17705	2.25 in	1.25 in	0.75 in	1.00 in	0.25 in	1/4-28 UNF	500 lb	\$26.50
17707	2.91 in	1.66 in	1.00 in	1.25 in	0.33 in	3/8-24 UNF	1,300 lb	\$26.50
17709	3.56 in	2.06 in	1.19 in	1.50 in	0.44 in	1/2-20 UNF	2,400 lb	\$28.50
17711	4.25 in	2.50 in	1.37 in	1.75 in	0.56 in	5/8-18 UNF	4,000 lb	\$34.00
17713	4.81 in	2.81 in	1.50 in	2.00 in	0.66 in	3/4-16 UNF	5,000 lb	\$74.00
17715	6.06 in	3.56 in	1.81 in	2.50 in	0.87 in	1-12 UNF	9,000 lb	\$117.00
17716	6.06 in	3.56 in	1.81 in	2.50 in	0.87 in	1-14 UNS	9,000 lb	\$117.00
17704	2.25 in	1.25 in	0.75 in	1.00 in	0.25 in	1/4-20 UNC	500 lb	\$23.00
17706	2.91 in	1.66 in	1.00 in	1.25 in	0.33 in	3/8-16 UNC	1,300 lb	\$25.00
17708	3.56 in	2.06 in	1.19 in	1.50 in	0.44 in	1/2-13 UNC	2,400 lb	\$25.00
17710	4.25 in	2.50 in	1.37 in	1.75 in	0.56 in	5/8-11 UNC	4,000 lb	\$38.00
17712	4.81 in	2.81 in	1.50 in	2.00 in	0.66 in	3/4-10 UNC	5,000 lb	\$58.00
17714	6.06 in	3.56 in	1.81 in	2.50 in	0.87 in	1-8 UNC	9,000 lb	\$59.00
17717	7.44 in	4.44 in	2.19 in	3.00 in	1.12 in	1 1/4-7 UNC	15,000 lb	\$169.00

*Do not exceed the safe load

Rod End Ball Joints

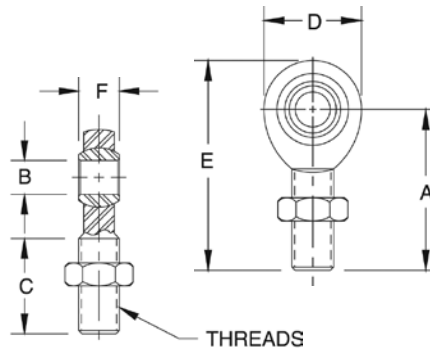

Standard Features

- Used in the ITCM assembly
- One jam nut included with each rod end ball joint
- Optional stainless steel provides enhanced corrosion resistance for hostile environments

Part Number/Price

Part #	Safe Load*	Breaking Strength	PTFE Lined	Price
Mild Steel				
17746	975 lb	3,915 lb	YES	\$34.00
17734	1,200 lb	4,916 lb	NO	\$24.00
17736	4,000 lb	16,238 lb	NO	\$60.00
17738	7,000 lb	28,081 lb	NO	\$103.00
17735	2,000 lb	8,075 lb	NO	\$29.00
17737	3,250 lb	13,831 lb	NO	\$42.00
17739	500 lb	2,158 lb	YES	\$34.00
17740	4,000 lb	16,238 lb	YES	\$55.00
17741	10,000 lb	40,572 lb	YES	\$82.00
17742	10,500 lb	43,541 lb	NO	\$154.00
26007	15,000 lb	76,200 lb	YES	\$318.00
17747	19,000 lb	76,200 lb	YES	\$366.00
17743	20,000 lb	79,728 lb	NO	\$276.00
17744	24,000 lb	96,510 lb	NO	\$382.00
Stainless Steel				
33505	500 lb	2,158 lb	YES	\$148.00
33506	1,500 lb	7,362 lb	YES	\$148.00
33507	3,000 lb	16,238 lb	YES	\$159.00
33508	7,000 lb	40,572 lb	YES	\$366.00

*Do not exceed the safe load

Dimensions

Part #	A	B	C	D	E	F	Thread Size
Mild Steel							
17746	1.94 in	0.37 in	1.25 in	1.00 in	2.43 in	0.50 in	3/8-24 UNF
17734	1.94 in	0.37 in	1.25 in	1.00 in	2.43 in	0.50 in	3/8-24 UNF
17736	2.44 in	0.50 in	1.50 in	1.31 in	3.09 in	0.62 in	1/2-20 UNF
17738	2.87 in	0.75 in	1.75 in	1.75 in	3.75 in	0.87 in	3/4-16 UNF
17735	2.44 in	0.50 in	1.50 in	1.31 in	3.09 in	0.62 in	1/2-20 UNF
17737	2.87 in	0.75 in	1.75 in	1.75 in	3.75 in	0.87 in	3/4-16 UNF
17739	1.56 in	0.25 in	1.00 in	0.75 in	1.93 in	0.37 in	1/4-28 UNF
17740	2.44 in	0.50 in	1.50 in	1.31 in	3.09 in	0.62 in	1/2-20 UNF
17741	2.87 in	0.62 in	1.75 in	1.75 in	3.75 in	0.75 in	3/4-16 UNF
17742	4.12 in	1.00 in	2.12 in	2.75 in	5.50 in	1.37 in	1-12 UNF
26007	4.12 in	1.00 in	2.12 in	2.75 in	5.50 in	1.37 in	1-14 UNS
17747	4.12 in	1.00 in	2.12 in	2.75 in	5.50 in	1.37 in	1-12 UNF
17743	4.12 in	1.25 in	2.12 in	2.75 in	5.50 in	1.09 in	1 1/4-12 UNF
17744	5.37 in	1.50 in	3.00 in	3.50 in	7.12 in	1.31 in	1 1/2-12 UNF
Stainless Steel							
33506	1.94 in	0.37 in	1.25 in	1.00 in	2.43 in	0.50 in	3/8-24 UNF
33505	1.56 in	0.25 in	1.00 in	0.75 in	1.93 in	0.37 in	1/4-28 UNF
33507	2.44 in	0.50 in	1.50 in	1.31 in	3.09 in	0.62 in	1/2-20 UNF
33508	2.87 in	0.62 in	1.75 in	1.75 in	3.75 in	0.75 in	3/4-16 UNF

Connecting Links

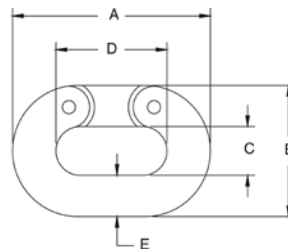

Standard Features

- Drop-forged carbon steel, heat-treated, hot-dipped galvanized finish

Part Number/Price

Part #	A	B	C	D	E	Safe Load*	Price
17794	1.50 in	1.00 in	0.43 in	0.87 in	0.25 in	1,325 lb	\$42.00
17795	2.06 in	1.37 in	0.56 in	1.12 in	0.37 in	2,750 lb	\$45.00
17796	2.65 in	1.71 in	0.65 in	1.46 in	0.50 in	4,750 lb	\$45.00
17797	3.31 in	2.09 in	0.78 in	1.81 in	0.62 in	7,250 lb	\$55.00
17798	3.87 in	2.50 in	0.93 in	2.12 in	0.75 in	10,250 lb	\$74.00
17799	5.00 in	3.31 in	1.25 in	2.75 in	1.00 in	15,500 lb	\$127.00

*Do not exceed the safe load

Load Cell Isolators



Power surges such as those caused by welding or electrical shorts frequently damage load cells and indicators. To prevent such damage, these isolators electrically separate the mechanical assembly from its tension-type load cell.

Part Number/Price

Part #	Height Thread Size	Diameter	Safe Load*	Price
17722	3/8-16 UNC	2.50 in	600 lb	\$48.00
17724	1/2-13 UNC	2.50 in	600 lb	\$53.00
17726	1/2-20 UNF	2.50 in	600 lb	\$90.00
17725	1/2-13 UNC	2.00 in	3,000 lb	\$127.00
17723	3/8-24 UNF	2.50 in	600 lb	\$95.00
17728	1/2-13 UNC × 1/2-20 UNF	2.50 in	600 lb	\$69.00
17732	1/4-20 UNC	1.12 in	250 lb	\$53.00

*Do not exceed the safe load

Threaded Adapters

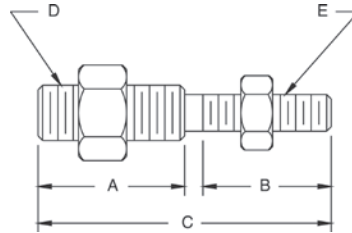

Standard Features

- For coupling isolators with load cells and steelyard rods
- Supplied with jam nuts
- Now in stronger, more durable stainless steel

Part Number/Price

Part #	A	B	C	D	E	Safe Load*	Price
33561	-	-	2.00 in	1/4-28 UNF	1/4-28 UNF	300 lb	\$29.00
33562	0.94 in	0.94 in	2.00 in	1/4-28 UNF	1/4-20 UNC	300 lb	\$32.00
33563	0.92 in	1.02 in	2.06 in	1/4-28 UNF	3/8-24 UNF	300 lb	\$37.00
33564	0.94 in	0.94 in	2.00 in	1/4-28 UNF	3/8-16 UNC	300 lb	\$29.00
33565	1.06 in	1.06 in	2.25 in	1/4-20 UNC	3/8-16 UNC	300 lb	\$32.00
33567	1.06 in	1.06 in	2.25 in	1/4-28 UNF	1/2-13 UNC	300 lb	\$32.00
33568	-	-	2.00 in	3/8-24 UNF	3/8-24 UNF	500 lb	\$42.00
33569	0.91 in	0.91 in	2.00 in	3/8-16 UNC	3/8-24 UNF	500 lb	\$36.00
33570	1.06 in	1.06 in	2.25 in	3/8-24 UNF	1/2-13 UNC	500 lb	\$32.00
33571	1.31 in	1.31 in	2.75 in	1/2-13 UNC	5/8-11 UNC	3,000 lb	\$32.00
33572	0.87 in	0.87 in	2.00 in	1/2-13 UNC	1/2-20 UNF	3,000 lb	\$36.00
33573	-	-	2.06 in	1/2-20 UNF	1/2-20 UNF	3,000 lb	\$36.00
33574	1.31 in	1.31 in	2.75 in	1/2-20 UNF	5/8-11 UNC	3,000 lb	\$38.00
33575	1.31 in	1.31 in	3.00 in	3/4-16 UNF	3/4-10 UNC	7,000 lb	\$40.00

*Do not exceed the safe load

ITCM Hardware Kits



Mount only - does not include load cell

The ITCM Isolated Tension Cell Mount is a mounting assembly designed for tension mounting S-beam load cells in suspended hopper assemblies and mechanical scale conversions. The ITCM incorporates clevis and unique rod end ball joint assemblies, reducing the overall length to less than half of traditional tension cell mounts, while providing correct load alignment. In addition, the load cell is completely electrically isolated from stray currents, a major cause of load cell failure. To complete the design, a grounding strap connects the two clevis assemblies to further ensure load cell safety.

Standard Features

- Provides greater safety than traditional/ suspension configurations
- Complete package for ease of installation
- Built-in electrical isolation without having to use isolators (not available on 20,000 lb version)
- Provides correct load cell loading even in difficult installations
- Dramatically reduces overall length
- Capacities from 300 to 20,000 lb
- Clevis mounts with nylon insulating washers
- PTFE-lined rod end ball joints (not available on 20,000 lb version)
- Completely isolates load cell from stray currents
- Grounding strap for electrical continuity
- Zinc plated clevis
- Mount only: does not include load cell

Applications

- Suspended hoppers
- Mechanical scale conversions
- Replaces traditional eye bolt, isolator configurations

Part Number/Price

Part #	Load Rating	Clevis Thread	Rod End Thread	Safe Load*	Price
Mild Steel					
17968	300 lb	3/8-16	3/8-24	300 lb	\$236.00
17969	300 lb	1/2-13	3/8-24	300 lb	\$236.00
17894	500 lb	3/8-16	1/4-28	500 lb	\$236.00
17895	500 lb	1/2-13	1/4-28	500 lb	\$236.00
17896	2,000 lb	1/2-13	1/2-20	2,000 lb	\$285.00
17897	2,500 lb	5/8-11	1/2-20	2,500 lb	\$285.00
17898	4,000 lb	3/4-10	1/2-20	4,000 lb	\$285.00
17899	5,000 lb	3/4-10	3/4-16	5,000 lb	\$325.00
17900	10,000 lb	1-8	3/4-16	10,000 lb	\$325.00
17958	15,000 lb (RL20000I)	1 1/4-7	1-12	15,000 lb	\$1,284.00
63166	15,000 lb (RL20001)	1 1/4-7	1-14	15,000 lb	\$1,229.00
17959	20,000 lb**	1 1/2-6	1 1/4-12	20,000 lb	\$1,134.00
Stainless Steel					
33630	500 lb	3/8-16	3/8-24	500 lb	\$643.00
33631	300 lb	1/2-13	3/8-24	300 lb	\$643.00
33632	500 lb	3/8-16	1/4-28	500 lb	\$643.00
33633	500 lb	1/2-13	1/4-28	500 lb	\$643.00
33634	2,000 lb	1/2-13	1/2-20	2,000 lb	\$774.00
33635	2,500 lb	5/8-11	1/2-20	2,500 lb	\$774.00
33636	3,000 lb	3/4-10	1/2-20	3,000 lb	\$774.00
33637	5,000 lb	3/4-10	3/4-16	5,000 lb	\$1,124.00

* Do not exceed the safe load **Not electrically isolated

Note: Replacement parts for mounts can be found in the Replacement Parts Catalog.

Grounding Strap



Standard Features

- Used in the ITCM assembly
- Tinned copper braid
- Crimped sleeve on ends with 0.25 in hole
- Available in 12 in, 14 in, 16 in, 24 in or 32 in lengths

Part Number/Price

Part #	Length	Price
17778	12 in	\$22.00
17779	14 in	\$22.00
17780	16 in	\$22.00
17781	24 in	\$22.00
17782	32 in	\$30.00

Ball Bearings



Standard Features

- Use with load cup and load receiver to build a custom scale
- 52100 chrome alloy steel

Part Number/Price

Part #	Drawing Dimensions	Price
18815	5/8 in diameter crush strength 32,000 lb	\$16.00
18816	7/8 in diameter crush strength 59,000 lb	\$18.00
65841	1.25 in diameter crush strength 100,000 lb	\$37.00

Load Receiver Plate

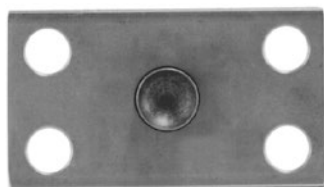

Standard Features

- Design offers accurate point loading
- Self-centering effect built in
- Use with load cup and ball bearings to build a custom scale
- Ball and cup load introduction provides point loading for maximum accuracy
- Stainless steel construction

Part Number/Price

Part #	Description	Price
18832	Load receiver plate	\$58.00

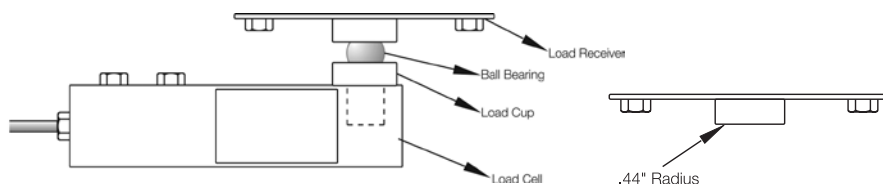
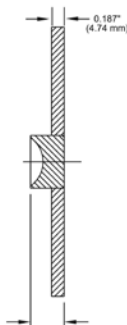
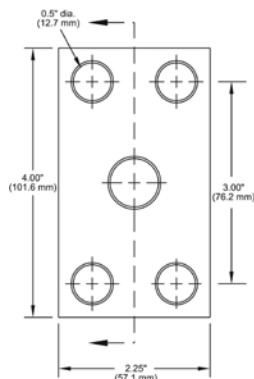

Load Cups

Standard Features

- Ball and cup load introduction provides point loading for maximum accuracy
- For use with most popular single-ended beam load cells
- Constructed of 440C

Part Number/Price

Part #	A	B	C	D	Price
31911	1.70 in	0.54 in	1.07 in	1/2-20 UNF	\$58.00
212364	1.70 in	0.54 in	1.07 in	M8	\$70.00
33654	1.12 in	0.54 in	0.78 in	1/2-20 UNF	\$47.00
33653	1.50 in	0.80 in	1.12 in	3/4-16 UNF	\$48.00
33652	2.00 in	0.85 in	1.75 in	1-12 UNF	\$114.00
33651	2.85 in	0.85 in	1.75 in	1-12 UNF	\$160.00
33650	2.85 in	0.85 in	1.75 in	1-14 UNF	\$160.00
33647	2.75 in	0.50 in	0.75 in	1/2-20 UNF	\$57.00
72364	1.78 in	0.53 in	0.78 in	1/2-20 UNF	\$69.00
69431	Replacement cup for Cardinal® SCA-50,000 load cell				\$143.00

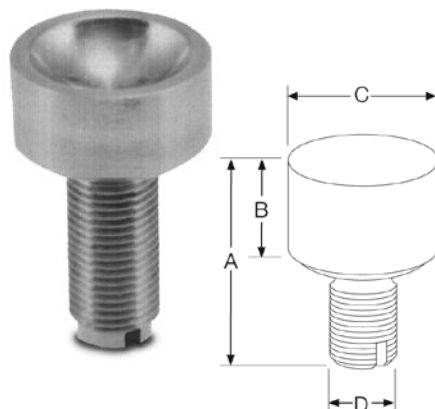

HARDWARE AND ACCESSORIES

Wire Rope Assemblies

Note: Wire ropes should not be exposed to shock loads, chemicals or twisting. Chains or rods should be used as a safety backup in case of catastrophic failure.

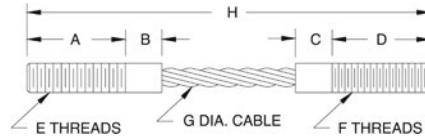

Wire Rope Assemblies

- Wire rope assemblies provide better alignment and greatly increase load cell repeatability. In addition, they act as natural vibration dampeners.

Part Number/Price

Part #	A	B & C	D	E	F	G	H	Safe Load*	Price
17760	0.87 in	0.50 in	0.87 in	1/4-20 UNC-2A	1/4-28 UNF-2A	0.12 in	4.00 in	400 lb	\$58.00
17762	1.25 in	0.50 in	1.25 in	3/8-16 UNC-2A	3/8-24 UNF-2A	0.18 in	5.00 in	850 lb	\$64.00
17766	1.62 in	0.50 in	1.62 in	1/2-13 UNC-2A	1/2-20 UNF-2A	0.25 in	6.50 in	1,400 lb	\$66.00
17765	1.62 in	0.50 in	1.62 in	1/2-13 UNC-2A	1/2-20 UNF-2A	0.25 in	5.50 in	1,400 lb	\$79.00
17764	1.00 in	-	1.37 in	1/2-20 UNF-2A	1/2-20 UNF-2A	0.25 in	4.00 in	1,400 lb	\$95.00
17768	2.00 in	-	2.50 in	3/8-24 UNF-2A	3/8-24 UNF-2A	0.12 in	5.50 in	400 lb	\$143.00
17769**	1.25 in	-	0.75 in	1/4-28 UNF-2A	1/4-28 UNF-2A	0.12 in	3.00 in	400 lb	\$159.00
17771**	1.25 in	-	0.75 in	1/2-20 UNF-2A	1/2-20 UNF-2A	0.25 in	3.00 in	1,400 lb	\$69.00
115292***	1.25 in	-	0.75 in	1/4-28 UNF-2A	1/4-28 UNF-2A	0.12 in	3.00 in	300 lb	\$111.00
33084****	1.31 in	-	1.00 in	1/2-20 UNF	1/2-20 UNF	0.125 in	3.62 in	850 lb	\$87.00

*Do not exceed the safe load **Used with Rice Lake Weighing Systems flexure bases ***Stainless steel ****Used with Rice Lake Weighing Systems FXB flexure bases

Cardinal® Wire Rope Assemblies

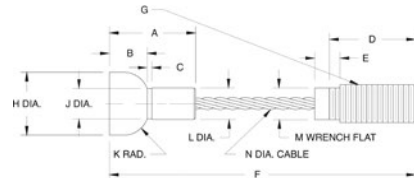

Part #17767 EL209

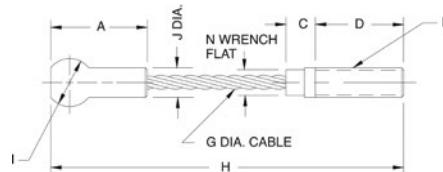

Part #17763 EL208

Cardinal Wire Rope Assemblies

- EL208 Cardinal wire rope assembly: Used on 7,500 lb capacity FH model and 8,000 lb capacity EP model
- EL209 Cardinal wire rope assembly: Used on 20,000 lb capacity FH and EP models. May also be used on 15,000 lb capacity FH and EP models

Part Number/Price

Part #	A	B	C	D	E	F	G	H	I	J	K	L & M	N	Safe Load*	Price
17763	1.50 in	-	0.50 in	1.50 in	-	1/2-13 UNC	0.25 in	6.00 in	0.81 in	0.43 in	-	-	0.43 in	1,400 lb	\$126.50
17767	1.71 in	0.75 in	0.09 in	2.00 in	0.43 in	6.31 in	3/4-10 UNC-2A	1.25 in	-	0.60 in	0.50 in	0.625 in	0.375 in	2,880 lb	\$247.50

*Do not exceed the safe load

Custom Wire Ropes

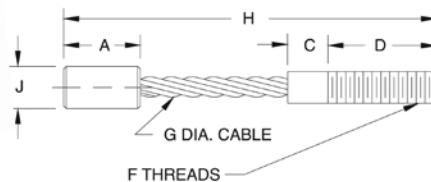

Custom Wire Ropes

- When ordering, please complete Custom Wire Rope Definition form and provide a sample if possible, and specify the required tension rating and total capacity
- Wire ropes should not be exposed to shock loads, chemicals or twisting. Chains or rods should be used as safety backup in case of catastrophic failure.

Custom Wire Rope Definition Form

Customer's Name: _____

Contact Person: _____

Date: _____

Application: _____

Wire Rope* (Enter Dimensions)

A Thread length	F Threads	K Safe load
B Shank length	G Rope diameter	L Environment
C Shank length	H Overall length	M Application
D Thread length	I Ball diameter	N Style
E Threads	J Shank diameter	O Desired Material

*Use drawings below for reference

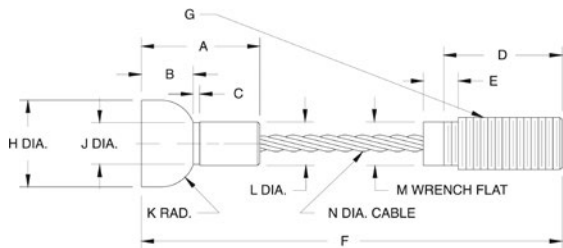

Style A

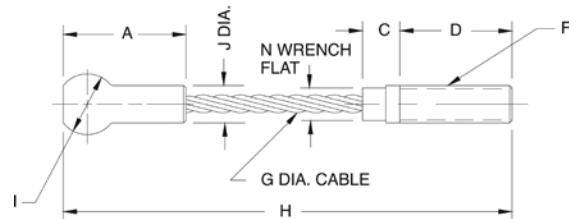

Style B

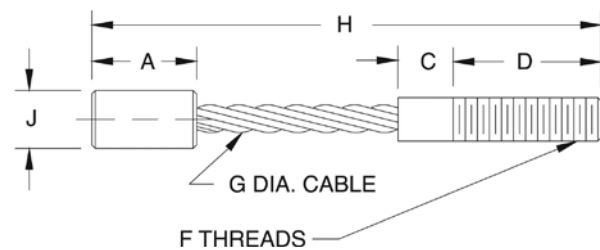

Style C

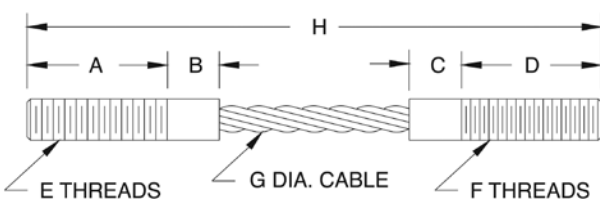

Style D



Style E

HARDWARE AND
ACCESSORIES

Spherical Washer Sets

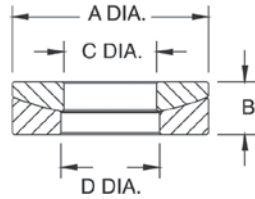

Part Number/Price

Part #	Bolt Size	A	B	C	D	Price
Mild Steel						
15196	0.25 in	0.62 in	0.20 in	0.28 in	0.31 in	\$16.00
15197	0.38 in	0.88 in	0.25 in	0.41 in	0.44 in	\$19.00
15198	0.50 in	1.12 in	0.31 in	0.53 in	0.56 in	\$8.50
15199	0.62 in	1.38 in	0.31 in	0.66 in	0.69 in	\$20.00
15200	0.75 in	1.62 in	0.38 in	0.78 in	0.81 in	\$25.00
15201	1.00 in	2.00 in	0.50 in	1.06 in	1.12 in	\$39.00
15202	1.25 in	2.62 in	0.50 in	1.31 in	1.38 in	\$72.00
15203	1.50 in	2.88 in	0.53 in	1.56 in	1.62 in	\$79.00
15205	2.00 in	3.88 in	0.81 in	2.06 in	2.12 in	\$127.00
Stainless Steel						
33218	0.50 in	1.12 in	0.31 in	0.53 in	0.56 in	\$27.00
33220	0.75 in	1.62 in	0.38 in	0.78 in	0.81 in	\$38.00

Weldless End Links

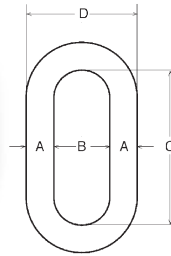

Standard Features

- Self-colored or hot-dip galvanized
- Forged carbon steel quenched and tempered

Part Number/Price

Part #	A	B	C	D	Safe Load*	Price
F312L	0.625 in	1.00 in	3.25 in	2.32 in	9,300 lb	\$58.00
17810	0.875 in	2.00 in	5.13 in	3.75 in	12,000 lb	\$175.00
21911	1.00 in	2.25 in	5.75 in	4.25 in	15,200 lb	\$344.00
65430	1.25 in	2.50 in	7.00 in	5.00 in	26,400 lb	\$159.00
21912	1.375 in	2.75 in	7.75 in	5.50 in	30,000 lb	\$488.00

*Do not exceed the safe load

Load Cell Spacers

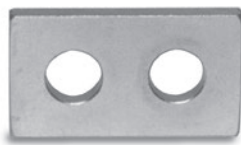

Standard Features

- Use with most popular single-ended beams
- Provides flat mounting surface required for optimal load cell performance
- Zinc-plated mild steel or stainless steel

Part Number/Price

Part #	C	H	H1	L	L1	L2	W	Price
Mild Steel								
17754	0.53 in	1.25 in	0.62 in	2.25 in	0.62 in	1.00 in	0.25 in	\$29.00
17755	0.78 in	1.50 in	0.75 in	3.00 in	0.75 in	1.50 in	0.25 in	\$29.00
17756	1.03 in	2.00 in	1.00 in	4.00 in	1.00 in	2.00 in	0.25 in	\$30.00
18260	0.53 in	1.25 in	0.62 in	2.25 in	0.62 in	1.00 in	0.37 in	\$31.00
Stainless Steel								
17757	0.78 in	1.50 in	0.75 in	3.00 in	0.75 in	1.50 in	0.25 in	\$37.00
18383	0.53 in	1.25 in	0.62 in	2.25 in	0.62 in	1.00 in	0.37 in	\$32.00
18411	0.53 in	1.25 in	0.62 in	2.25 in	0.62 in	1.00 in	0.25 in	\$33.00

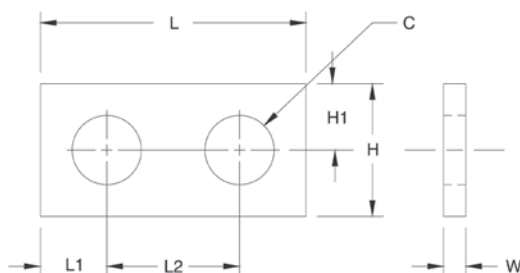

Load Button



Standard Features

- Suitable for use with compression mounting assemblies, canisters, s-beams and single-ended beams
- Hardened alloy steel

Part Number/Price

Part #	T	D	H	H1	R	W	Price
17750	3/8-24 UNF	0.75 in	0.60 in	0.30 in	2.00 in	0.63 in	\$37.00
17751	1/2-20 UNF	0.75 in	0.70 in	0.30 in	4.00 in	0.63 in	\$32.00
17752	3/4-16 UNF	1.50 in	0.90 in	0.30 in	6.00 in	1.25 in	\$50.00

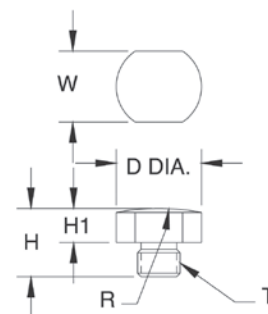

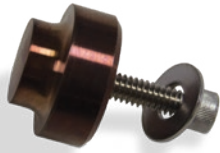

Standard Features

- To be used with RLSSB and VPG Revere SSB load cells (1,000 to 5,000 lb)
- Hardened alloy steel

Part Number/Price

Part #	Description	Price
26112	Load button insert kit	\$37.00

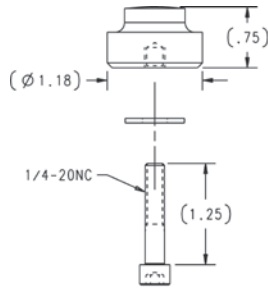

Standard Features

- Replacement foot, adapts to most floor scales
- Use with single-ended beams to provide large, flat, adjustable introduction surface
- Special neoprene rubber sandwich base gives high accuracy, linearity and repeatability

Part Number/Price

Part #	Material	Thread Size	Base Ht.	Total Ht.	Diameter	Price
18756	Stainless steel	1/2-20 UNF	0.75 in	2.62 in	3.47 in	\$50.00
39021	Mild steel	3/4-16 UNF-2B	0.875 in	3.25 in	4.40 in	\$93.00
39022	Mild steel	3/4-16 UNF-2B	0.875 in	4.06 in	5.40 in	\$135.00
110930	Mild steel	1-14 UNF	1.00 in	4.06 in	5.40 in	\$235.00
42130	Stainless steel	M12	-	2.62 in	3.47 in	\$103.00

Flintec™ Adjustable Rubber Foot



SLB, SB4, SB5, SB14 and SB6



BK2

Standard Features

- Blind hole introduction
- Low profile
- Height adjustable by rotation
- Includes spacer
- Stainless steel

Part Number/Price

Part #	Foot Diameter	Load Cell Capacity	Price
Flintec SLB, SB4, SB5, SB14 and SB6			
46230	2.36 in	200 to 500 lb	\$65.00
77561	3.14 in	1,000 to 5,000 lb	\$65.00
Flintec BK2			
87096	3.140 in	200 to 2,000 kg	\$65.00

Bench Scale Feet



107476



19141



35128

Standard Features

- Rubber pad, 1/4-20 UNC threads
- Stainless steel, 3/8-16 UNC thread

Part Number/Price

Part #	Description	Price
Rubber Pad		
35128	Bench scale feet	\$14.00
107476	CW 90/CW 90X feet	\$21.00
Stainless Steel		
19141	Bench scale feet	\$8.00

Polyurethane Rubber Leveling Feet



Standard Features

- 3 in overall height, all diameters
- Stainless steel stem for corrosion resistance
- Heavy-duty construction, low-cost replacement feet
- Four standard diameters all with 1/2-20 UNF stainless steel stud, slotted for top-access applications
- Stainless steel jam nut provided
- Top of stud is machined undersize 10% for easy alignment into load cell

Part Number/Price

Part #	Foot Diameter	Height	Price
74585	1.87 in	3.00 in	\$32.00
74586	2.00 in	3.00 in	\$32.00
74587	2.50 in	3.00 in	\$32.00
73801	3.00 in	3.00 in	\$32.00

Captured Ball Floor Scale Leveling Feet



Carbon

Stainless Steel

Standard Features

Carbon steel

- Bright zinc and clear chromate plating for corrosion resistance
- Active ball suspension provides ideal load cell loading with maximum side load protection
- Hardened alloy steel with plated finish
- Includes two jam nuts, one for wrench access
- Top of stud is machined undersized 10% for easy alignment into load cell plus slotted for top-access applications

Stainless steel

- Provides outstanding accuracy, repeatability and performance
- Active ball suspension provides optimal load cell performance
- Hardened stainless steel material, welded with polished finish
- Includes two stainless steel jam nuts, one for wrench access
- Top of stud is machined undersized 10% for easy alignment into load cell plus slotted for top-access applications

Part Number/Price

Part #	Foot Diameter	Thread Size Inches	Height	Price
Carbon Steel				
74578	1.87 in	1/2-20 UNF	3.5 in	\$45.00
74579	2.00 in	1/2-20 UNF	3.5 in	\$45.00
74580	2.50 in	1/2-20 UNF	3.5 in	\$45.00
74581	3.00 in	1/2-20 UNF	3.5 in	\$45.00
74582	3.00 in	3/4-16 UNF	4.5 in	\$56.00
74583	3.00 in	1-12 UNF	4.5 in	\$67.00
74584	3.00 in	1-14 UNF	4.5 in	\$67.00
171449	3.00 in	1-14 UNF	5.0 in	\$83.00
173018	4.40 in	3/4-16 UNF	3.13 in	\$96.00
174937	5.40 in	3/4-16 UNF	4.13 in	\$139.00
Stainless Steel				
74572	1.87 in	1/2-20 UNF	3.5 in	\$80.00
74573	2.00 in	1/2-20 UNF	3.5 in	\$80.00
73800	2.50 in	1/2-20 UNF	3.5 in	\$80.00
74574	3.00 in	1/2-20 UNF	3.5 in	\$80.00
74575	3.00 in	3/4-16 UNF	4.5 in	\$113.00
74576	3.00 in	1-12 UNF	4.5 in	\$136.00
74577	3.00 in	1-14 UNF	4.5 in	\$136.00
92380*	2.50 in	1/2-20 UNF	3.5 in	\$80.00
175615	3.47 in	1/2-20NF	2.62 in	\$108.00

*Stem is fully threaded

Leveling Pads

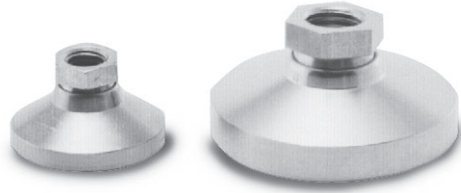

Standard Features

- Replacement feet adapt to most floor scales
- Available in mild steel or stainless steel
- Simple swivel design
- Use with single-ended shear beams or bending beams to provide a large, flat load introduction surface

Part Number/Price

Part #	Thread Size	Height	Diameter	Price
Mild Steel				
18817	1/2-13 NC	1.12 in	1.87 in	\$27.00
18820	3/4-10 NC	1.50 in	3.00 in	\$47.00
Stainless Steel				
18818	1/2-13 NC	1.12 in	1.87 in	\$63.00
18833	3/4-10 NC	1.50 in	3.00 in	\$109.00

Used in conjunction with leveling pad stems

Leveling Mount



Standard Features

- Designed for use with some floor scales or machinery platforms
- Can limit vibrations transmitted to the scale through the floor
- Provides vibration isolation on most portable platforms

Part Number/Price

Part #	Thread Size	Height	Diameter	Price
18819	1/2-13 NC	1.81 in	5.00 in	\$106.00

Leveling Pad Stems

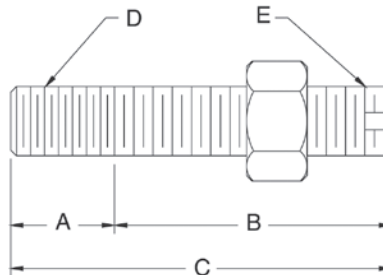

Standard Features

- For use with leveling pads
- One jam nut included

Part Number/Price

Part #	A	B	C	D	E	Slot	Material	Price
Mild Steel								
17693	0.75 in	2.00 in	2.75 in	3/4-10 UNC	3/4-16 UNF	No	1045	\$17.00
Stainless Steel								
17689	0.50 in	1.50 in	2.00 in	1/2-13 UNC	1/2-20 UNF	Yes	Stainless steel	\$25.00
17695	0.75 in	2.00 in	2.75 in	3/4-10 UNC	3/4-16 UNF	No	Stainless steel	\$40.00

Warning: Do not use to suspend a load

RoughDeck® Scale Base

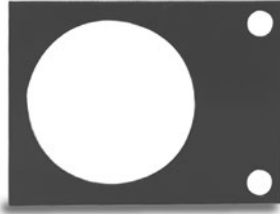

Part Number/Price

Part #	Description	Price
19075	Mild steel, 1,000 to 10,000 lb	\$19.00
19076	Stainless steel, 1,000 to 10,000 lb	\$24.00

Dimensions

Part #	C	C1	H	H1	H2	H3	L	L1	L2	W
19075	3.62 in	0.56 in	4.50 in	2.25 in	0.50 in	3.50 in	6.00 in	0.50 in	3.75 in	0.25 in
19076	3.62 in	0.56 in	4.50 in	2.25 in	0.50 in	3.50 in	6.00 in	0.50 in	3.75 in	0.25 in

Standard Features

- Secures RoughDeck and other popular floor scales
- Prevents movement in horizontal plane
- Useful with SureFoot™ and other load cell foot assemblies
- Available in stainless steel and mild steel

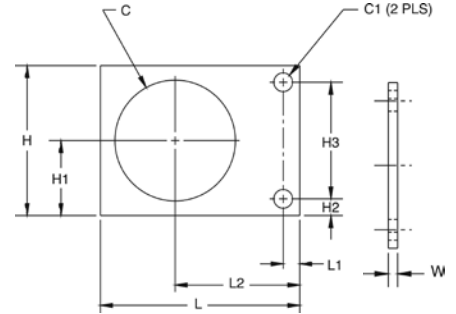

Summit® 3000 Scale Base



Part Number/Price

Part #	Description	Price
76149	Mild steel, 2,000 to 10,000 lb	\$19.00

Dimensions

Part #	C	C1	H	H1	H2	H3	L	L1	L2	W
76149	3.19 in	0.56 in	4.50 in	2.25 in	0.50 in	3.50 in	6.00 in	0.50 in	3.75 in	0.25 in

Standard Features

- Mounting plate for Summit® 3000 floor scales

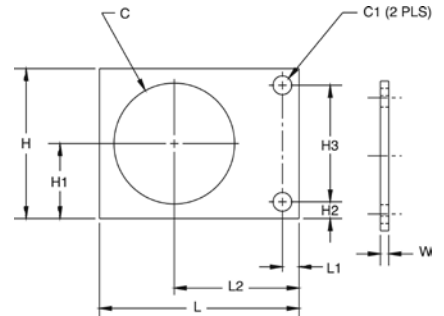

Floor Scale Base

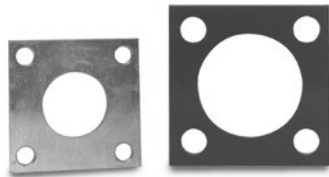

Part Number/Price

Part #	Description	Price
18737	Mild steel, 1,000 to 10,000 lb	\$9.00
18738	Mild steel 10,000 to 20,000 lb	\$10.00
18751	Stainless steel 1,000 to 10,000 lb	\$34.00

Dimensions

Part #	C	C1	H	H1	H2	H3	L	L1	L2	L3
18737	2.00 in	0.53 in	4.00 in	2.00 in	0.50 in	3.00 in	4.00 in	2.00 in	0.50 in	3.00 in
18738	3.25 in	0.81 in	5.00 in	2.50 in	0.75 in	3.50 in	5.00 in	2.50 in	0.75 in	3.50 in
18751	2.00 in	0.53 in	4.00 in	2.00 in	0.50 in	3.00 in	4.00 in	2.00 in	0.50 in	3.00 in

Standard Features

- Suitable for use with leveling pads
- Generic mounting plate for popular floor scales
- Fits most floor scale foot assemblies
- Available in stainless steel and mild steel (mild steel parts are zinc plated/painted)

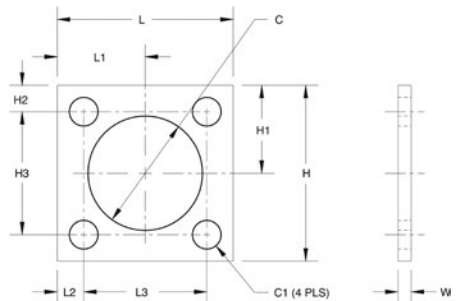

Complete Custom Cable Services



Specifications

Jacket Material:

PVC
Polyurethane
Double-jacketed

Conductors:

Unlimited number
Twisted pairs
Color code
Gauge

Shielding:

Braided
Foil

Jacket Colors:

Black, brown, green, orange, red, blue, yellow, gray, natural

Ink Colors:

Black, white, silver, orange
Custom logos

Approvals



Standard Features

- Special cable requirements
- Custom-built cable designed specifically for your application
- Choose from design elements and Rice Lake Weighing Systems will build a cable to your specifications
- Quick turnaround
- Competitively priced
- 5,000 ft minimum purchase

EL147, 6 Wire

Standard Load Cell Cable

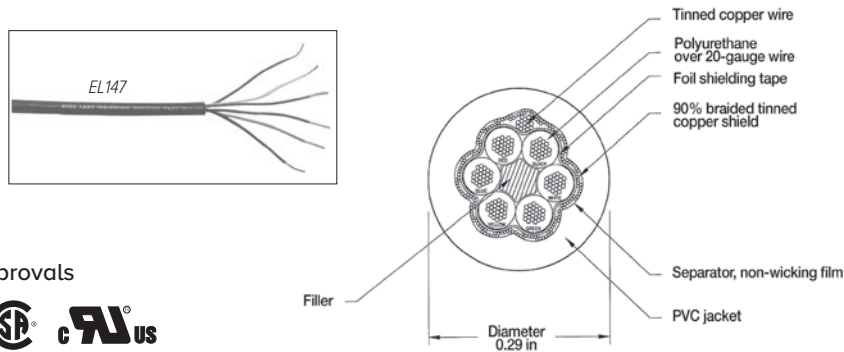

Approvals



Standard Features

- 20 AWG tinned copper wire stranded for flexibility
- Braided shielding is encased in red PVC
- All conductors are industry-standard color coded
- Diameter: 0.29 in
- The six-wire cable is best suited for longer runs where remote sense lines can be used
- Temperature rating: -22 °F to 126 °F (-30 °C to 80 °C)

Part Number/Price

Part #	Continuous Roll	Description	Price
15515	100 ft	Six-conductor cable	\$228.00
15516	250 ft	Six-conductor cable	\$503.00
15517	500 ft	Six-conductor cable	\$938.00
15518	1,000 ft	Six-conductor cable	\$1,828.00
15495	Custom length	Six-conductor cable	\$2.28/ft

EL147RP Plus, 6 Wire

Rodent Protection Load Cell Cable

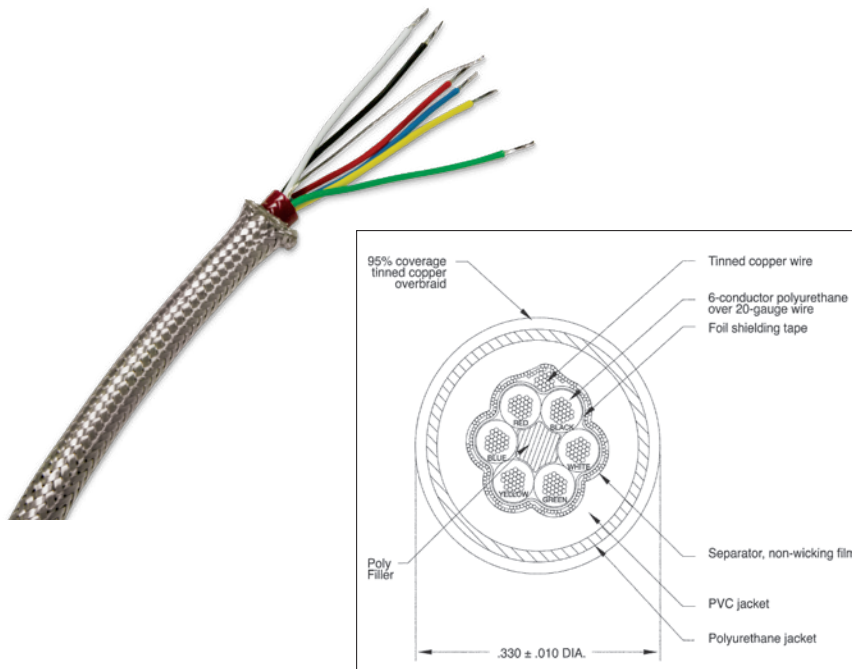

Standard Features

- Tinned copper overbraid provides superior rodent and abrasion deterrent
- Enhanced EMI/RFI protection
- Six-conductor industry-standard color code
- Ideal for truck and railroad-track scales
- Diameter: 0.33 in
- Temperature rating: -22 °F to 176 °F (-30 °C to 80 °C)
- Jacket coating enhanced with a chemical coating "NAW" that is distasteful to rodents

Part Number/Price

Part #	Continuous Roll	Description	Price
31475	Custom length	Six-conductor rodent protection cable	\$4.00/ft
131964	100 ft	Six-conductor rodent protection cable	\$397.00
131965	250 ft	Six-conductor rodent protection cable	\$917.00
131966	500 ft	Six-conductor rodent protection cable	\$1,818.00
131967	1,000 ft	Six-conductor rodent protection cable	\$3,524.00

HARDWARE AND ACCESSORIES

EL147HE, 6 Wire

Hostile Environment Load Cell Cable

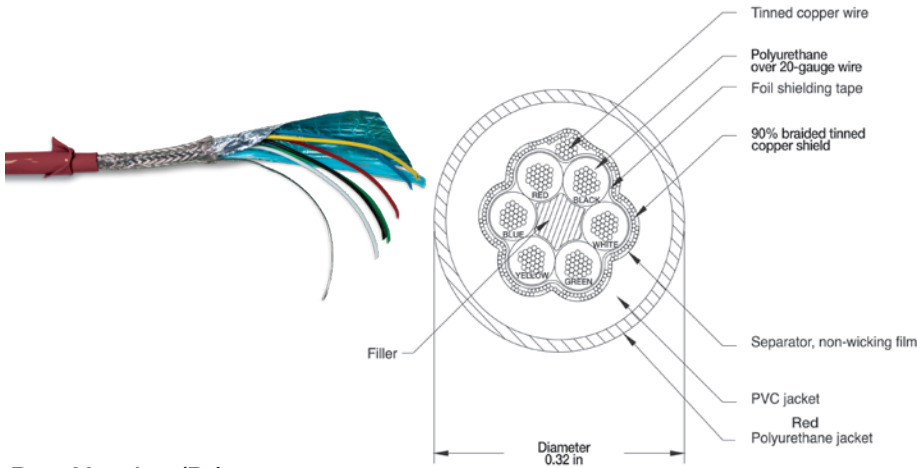

Standard Features

- Designed for use in hostile environments
- Polyurethane jacketing provides superior chemical and abrasion resistance
- RFI and EMI protected with foil overbraid shield
- Unmatched durability, yet extremely flexible
- All conductors are industry-standard color coded
- Diameter: 0.32 in
- Temperature rating: -22 °F to 176 °F (-30 °C to 80 °C)
- 500 V rating

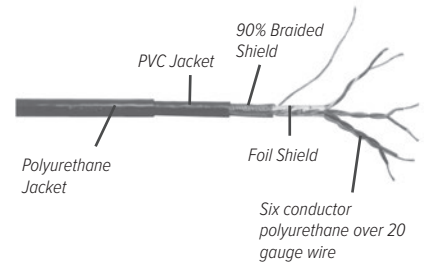

Part Number/Price

Part #	Continuous Roll	Description	Price
15520	100 ft	Six-conductor hostile environment cable	\$265.00
15521	250 ft	Six-conductor hostile environment cable	\$636.00
15522	500 ft	Six-conductor hostile environment cable	\$1,182.00
15523	1,000 ft	Six-conductor hostile environment cable	\$2,050.00
15496	Custom length	Six-conductor hostile environment cable	\$2.80/ft

EL147IS, 6 Wire

Hazardous Environment Blue Jacket Load Cell Cable

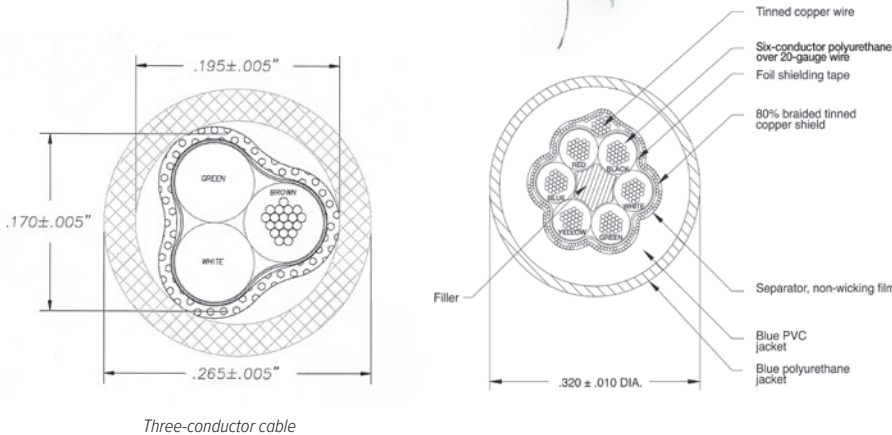

Standard Features

- Designed for intrinsically safe applications (must be wired according to Factory Mutual System-approved diagram)
- Polyurethane over PVC double jacketing provides superior chemical and abrasion resistance
- Both foil and braided wire shields for added RFI and EMI protection
- Six-conductor is industry-standard color coded (Also available three-conductor)
- Suited for longer runs where remote sense lines can be used
- Temperature rating: -22 °F to 176 °F (-30 °C to 80 °C)
- Diameter: 0.32 in

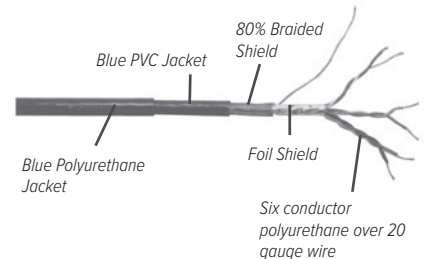

Part Number/Price

Part #	Description	Price
32817	EL147IS, blue jacket six-conductor	\$3.34/ft
72241	Blue jacket, shielded three-conductor, UL and CSA recognized	\$2.95/ft

HARDWARE AND ACCESSORIES

EL146, 4 Wire

Standard Load Cell Cable

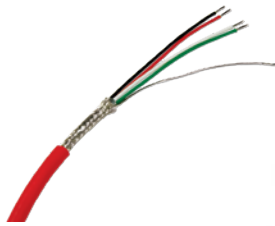

Approvals

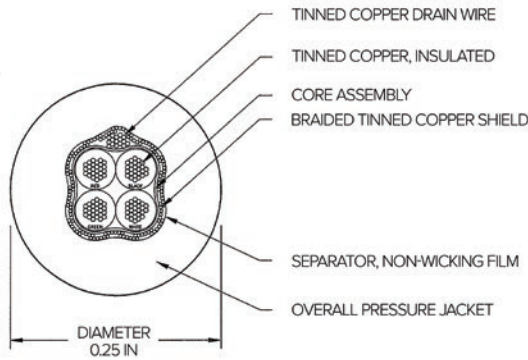

Standard Features

- Four-wire load cell cable
- 20 AWG tinned copper wire stranded for flexibility
- Braided shielding is encased in red PVC
- All conductors are industry-standard color coded
- Diameter: 0.25 in
- Use the four-wire cable for repairing or extending existing cable
- Temperature rating: -22 °F to 126 °F (-30 °C to 80 °C)

Part Number/Price

Part #	Continuous Roll	Description	Price
15505	100 ft	Four-conductor cable	\$143.00
15506	250 ft	Four-conductor cable	\$334.00
15507	500 ft	Four-conductor cable	\$652.00
15508	1,000 ft	Four-conductor cable	\$1,075.00
15493	Custom length	Four-conductor cable	\$1.55/ft

EL146HE, 4 Wire

Hostile Environment Load Cell Cable

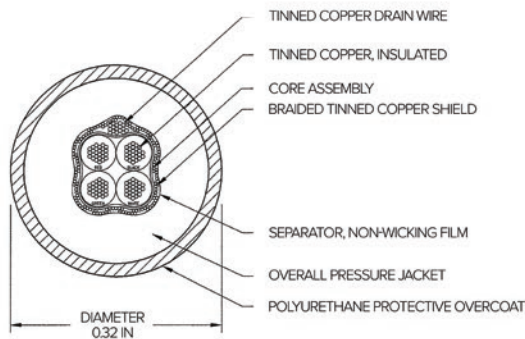
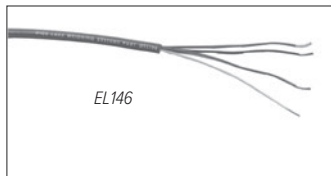

Standard Features

- Designed for use in hostile environments
- Polyurethane jacketing provides superior chemical and abrasion resistance
- RFI and EMI protected with foil overbraid shield
- Unmatched durability, yet extremely flexible
- All conductors are industry-standard color coded
- Diameter: 0.32 in
- Temperature rating: -22 °F to 176 °F (-30 °C to 80 °C)
- 500 V rating

Part Number/Price

Part #	Continuous Roll	Description	Price
15510	100 ft	Four-conductor hostile environment cable	\$175.00
15511	250 ft	Four-conductor hostile environment cable	\$424.00
15512	500 ft	Four-conductor hostile environment cable	\$805.00
15513	1,000 ft	Four-conductor hostile environment cable	\$1,606.00
15494	Custom Length	Four-conductor hostile environment cable	\$1.96/ft

HARDWARE AND ACCESSORIES

EL144 Communications Cable

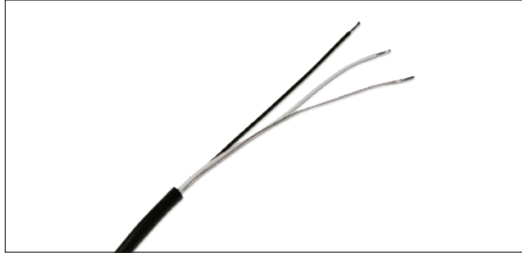

Standard Features

- Two-conductor with bare ground
- RFI/EMI protected with foil shield
- 20 gauge conductors
- Perfect for RS-232, two-wire RS-485 and 20 mA current loop communications
- Diameter: 0.19 in
- Conductor colors are black and white

Part Number/Price

Part #	Description	Price
32803	EL144	\$1.22/ft
72691	EL144, 100 ft	\$90.00
72072	EL144, 500 ft	\$477.00
72693	EL144, 1,000 ft	\$865.00

BCD Cable

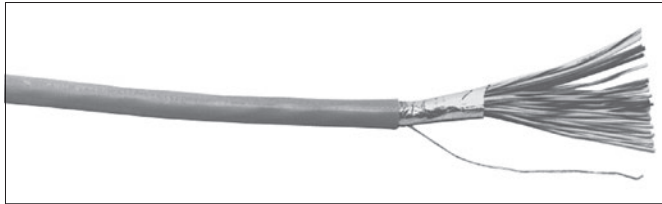

Standard Features

- Sheathed in gray PVC
- Mylar aluminum foil shield with stranded tinned copper drain wire
- Diameter: 0.375 in

Part Number/Price

Part #	Description	Price
15497	BCD, 24 AWG, 30-conductor	\$29.00/ft

Fiber-Optic Cable



Color Code: Black-TXD, Blue-RXD

Standard Features

- Duplex cable polyethylene black jacket material
- 4.4 + 0.10 mm outer diameter of duplex cable
- 2.2 + 0.007 mm single cable outer diameter
- Operating temperature: 32 °F to 158 °F (0 °C to 70 °C)

Part Number/Price

Part #	Description	Price
78910	Custom length	\$1.75/ft
78026	100 ft cable	\$175.00
78027	200 ft cable	\$328.00
78028	300 ft cable	\$425.00
83052*	Fiber-optic connector	\$48.00
80892	Fiber-optic cable cutter	\$12.00
85548	Fiber-optic hot knife	\$55.00

*Duplex fiber cable requires two connectors

SURVIVOR® EL620HE

High Temperature Cable



Standard Features

- Multi-conductor overall foil and braid shield
- Suitable for temperatures from -40 °C (-40 °F) to 200 °C (392 °F)
- Insulation thickness: 0.010 in
- Jacket thickness: 0.017 in
- 18 gauge, tinned copper conductors
- Six-conductor
- FEP jacket, resistant to chemical corrosion and high temperature
- Aluminum-polyester shield with 85% tinned copper braid shield
- 150 V NEC 725 Class 2 classified for use in an air plenum non-conduit
- 0.24 in diameter cable

Part Number/Price

Part #	Description	Price
15605	EL620HE	\$13.00/ft

SURVIVOR® Cable Armor

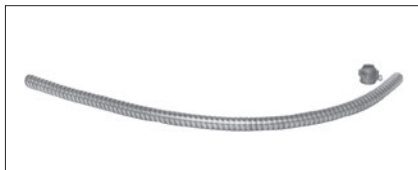

Standard Features

- Flexible all-metal protective armor
- Ideal for protecting load cell cable from mechanical abrasion or rodents
- Available in stainless steel and galvanized steel
- 0.5 in internal diameter, 2.0 in minimum bend radius
- Optional end fitting with 1/2 in male pipe thread

Part Number/Price

Part #	Description	Price
17808	Galvanized steel	\$4.50/ft
17806	Stainless steel	\$5.50/ft
17807	Optional end fitting	\$2.65 each

EL148HE Mettler Toledo®

Replacement Power Cell Cable



Standard Features

- 100% stainless steel military connector-electro deposited nickel plating with stainless banding and epoxy heat-shrink strain relief
- Stainless steel arctic ring precision cut for improved connection
- Textured rubber boot for additional grip
- Standard Mettler Toledo color code
- Compatible with Mettler Toledo Powercell CMOS/NMOS and MTX load cells. NOT compatible with Mettler Toledo PDX load cells.
- Custom lengths available

Part Number/Price

Part #	Cable Length Each	Price
100268	8 ft	\$387.00
101102	12 ft	\$397.00
104164	15 ft	\$380.00
100269	26 ft	\$419.00
100270	35 ft	\$440.00

Mettler Toledo® Power Cell®

Homerun Cable

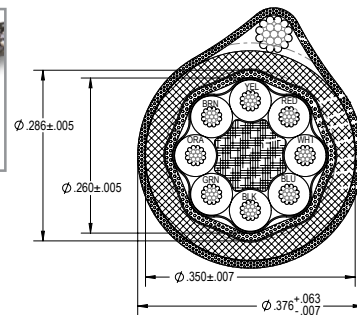

Standard Features

- Galvanized steel drain wire
- 20 gauge 8 conductors
- Stainless steel braid shield

Part Number/Price

Part #	Description	Price
194837	Galvanized steel	\$8.50/ft

HARDWARE AND ACCESSORIES

Load Cell Conduit Adapters

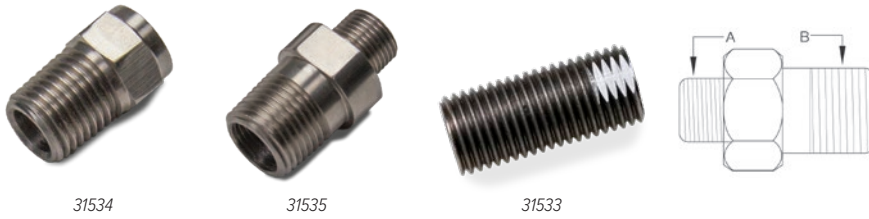

Standard Features

- Used to adapt conduit to load cells
- 303 stainless steel

Part Number/Price

Part #	A	B	Price
Thread-On			
31533	3/8-24 UNF	—	\$37.00
31534	—	1/4-18 NPT	\$37.00
31535	5/8-18 UNF	1/2-14 NPT	\$37.00

Note: 31533 and 31534 are used together to form male-to-male adapter

Cord Grip Assemblies

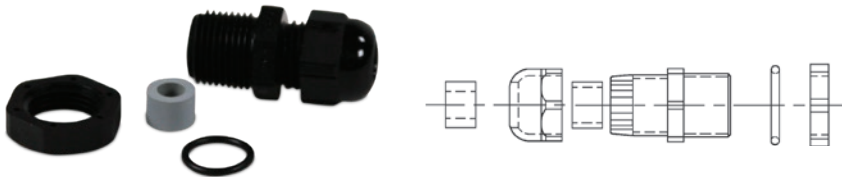

Standard Features

- Assemblies include cord grip, locknut, O-ring seal, gray and black reducer glands
- Fittings are made of weather- and corrosion-resistant nylon

Part Number/Price

Gland Cable Ranges					
Part #	Thread	Panel Hole Diameter	Regular (Black)	Reducer (Gray)	Price
15669	PCN9	0.625 in	0.157 to 0.314 in	0.118 to 0.236 in	\$5.25
15670	3/8 NPT	0.687 in	0.157 to 0.314 in	0.118 to 0.236 in	\$4.75
15671	1/2 NPT	0.844 in	0.236 to 0.472 in	0.200 to 0.354 in	\$5.50

EL214 Cable Splicing Kit



Standard Features

- Designed for a complete, professional transducer cable splice
- Prevents moisture from entering the load cell through the cable connector
- Each kit contains a high-impact plastic splicing box, liquid-tight cable fittings, circuit card, PTFE sleeving, pre-measured potting compound and complete instructions
- Solder terminals

Specifications

Dimensions:

(L × W × H)
3.00 × 1.00 × 1.50 in

Mounting Centers:

2.50 in

Number of Connections:

7

Cable Diameter:

0.187 to 0.312 in

Cure Time For Potting:

Epoxy-Polyamide resin cures in 2 hours at 73 °F (23 °C)

Part Number/Price

Part #	Description	Price
15485	EL214	\$143.00

EL214T Cable Splicing Kit



Standard Features

- Designed to accommodate cables larger than the EL214; all other dimensions and performance features are the same
- Solder terminals

Specifications

Dimensions:

(L × W × H)
3.00 × 1.00 × 1.50 in

Mounting Centers:

2.50 in

Number of Connections:

7

Cable Diameter:

0.187 to 0.312 in

Cure Time For Potting:

Epoxy-Polyamide resin cures in 2 hours at 73 °F (23 °C)

Part Number/Price

Part #	Description	Price
15486	EL214T	\$154.00

EL215 Cable Splicing Kit



Standard Features

- Designed for use in weather-exposed or direct-burial locations
- Each kit contains plastic splicing tube, circuit board, insulating resin and instructions
- Solder terminals

Specifications

Dimensions:

(L × W)
6.00 × 1.38 in

Number of Connections:

7

Cable Diameter:

Up to 0.75 in

Cure Time For Potting:

2 hours at 70 °F (21 °C)

Part Number/Price

Part #	Description	Price
15612	EL215	\$116.00

Flintec™ Load Cell Cable

Replacement Kits



Standard Features

- Each kit includes cable for four Flintec SB4 load cells as listed

Part Number/Price

Part #	Description	Cable Length Ea. Feet	Price
18412	For SB4, 225 to 5,200 lb	10 ft	\$370.00
18413	For SB4, 11,250 to 22,500 lb	15 ft	\$397.00

Five-Position Connectors, Shell Plugs, Receptacles

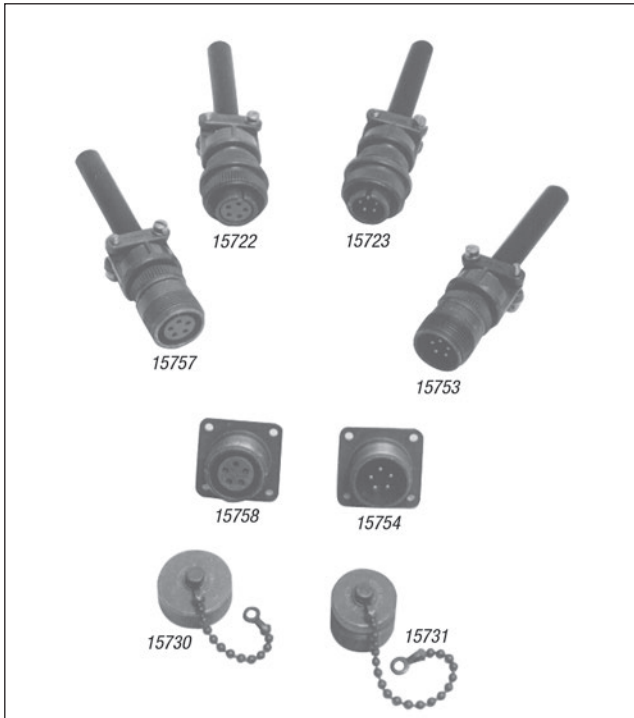

Six-Position Connectors, Shell Plugs, Receptacles

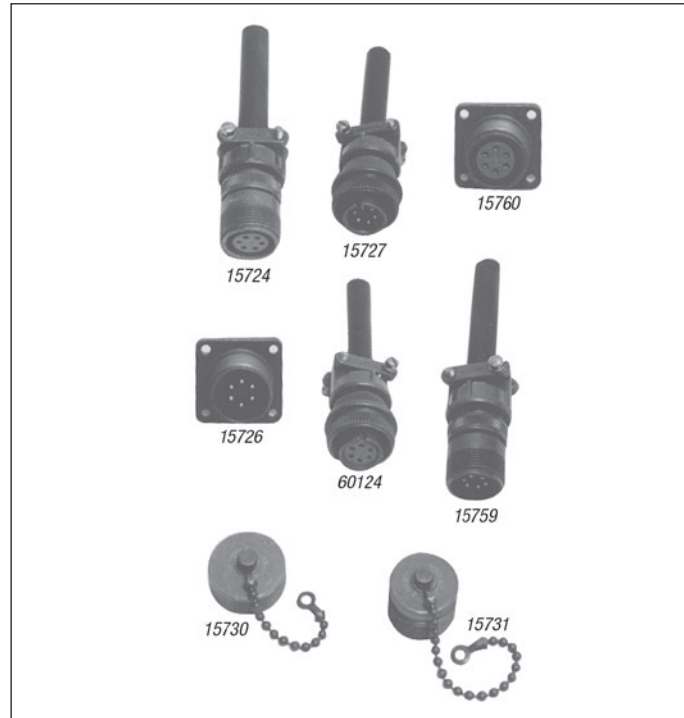

Seven-Position Connectors, Shell Plugs, Receptacles

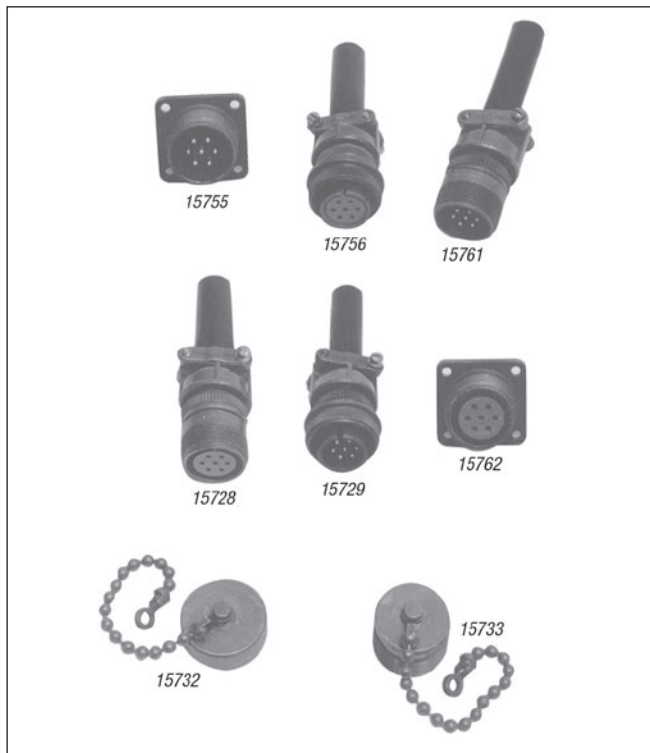

Part Number/Price

Part #	Description	Price
15753	Five-pin, external thread	\$32.00
15722	Five-socket, internal thread	\$33.00
15723	Five-pin, internal thread	\$32.00
15757	Five-socket, external thread	\$37.00
15754	Five-pin chassis mount, external thread	\$37.00
15758	Five-socket chassis mount, external thread	\$23.00
15730	Dust cap for ext. thread five-position connector	\$14.00
15731	Dust cap for int. thread five-position connector	\$19.00
15759	Six-pin, external thread, male	\$32.00
60124	Six-socket, internal thread connector, female fits Toledo load cells, Condec indicators	\$27.00
15727	Six-pin, internal thread, male	\$31.00
15724	Six-socket, external thread	\$35.00
15726	Six-pin chassis mount, external thread	\$24.00
15760	Six-socket chassis mount, external thread	\$23.00
15730	Dust cap for ext. thread six-position connector	\$14.00
15731	Dust cap for int. thread six-position connector	\$19.00
15761	Seven-pin, external thread	\$33.00
15756	Seven-socket, internal thread	\$35.00
15729	Seven-pin, internal thread	\$35.00
15728	Seven-socket, external thread	\$35.00
15755	Seven-pin chassis mount, external thread	\$24.00
15762	Seven-socket chassis mount, external thread	\$27.00
15732	Dust cap for ext. thread seven-position connector	\$20.00
15733	Dust cap for int. thread seven-position connector	\$31.00

T-Grip Molding

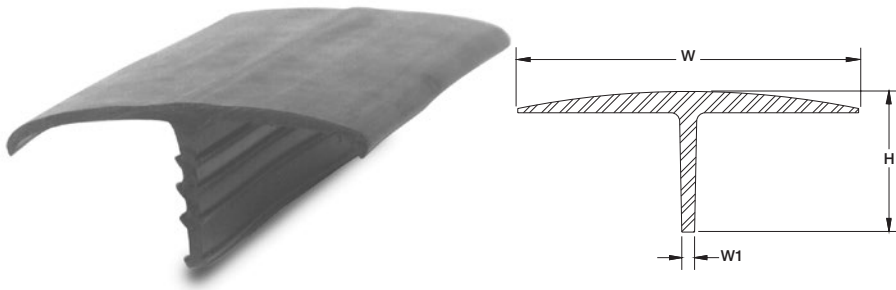

Standard Features

- Impact, tear and weather-resistant EPDM rubber
- Barbed web to hold molding in place
- Web thickness 0.22 in
- Available by the foot: 10 ft, 11 ft, 70 ft, 80 ft and 100 ft lengths
- Maximum continuous length is 450 ft

Part Number/Price

Part #	H	W	W1	Length	Price
18799	2.56 in	5.75 in	0.22 in	Sold by the foot	\$13.00/ft
18800	2.56 in	5.75 in	0.22 in	10 ft	\$100.00
18801	2.56 in	5.75 in	0.22 in	11 ft	\$110.00
18802	2.56 in	5.75 in	0.22 in	70 ft	\$795.00
33219	2.56 in	5.75 in	0.22 in	80 ft	\$895.00
33222	2.56 in	5.75 in	0.22 in	100 ft	\$1,125.00

Note: Maximum continuous length is 450 ft. Call for price and availability.

T-Strip Molding

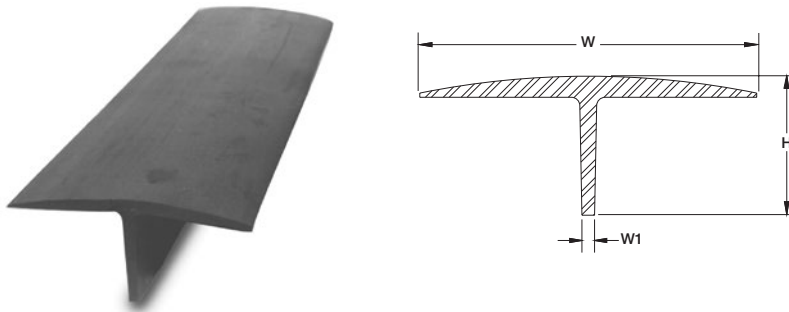

Standard Features

- Designed for use in truck scale applications to prevent spillover into the pit
- Impact, tear and weather-resistant SBR rubber
- Web thickness 0.25 in
- Available by the foot: 10 ft, 11 ft, 70 ft, 80 ft and 100 ft lengths
- Maximum continuous length is 450 ft
- Designed for use in truck scale applications to prevent spillover into the pit

Part Number/Price

Part #	H	W	W1	Length	Price
18736	2.00 in	4.50 in	0.25 in	Sold by the foot	\$12.00/ft
18776	2.00 in	4.50 in	0.25 in	10 ft	\$95.00
18797	2.00 in	4.50 in	0.25 in	11 ft	\$105.00
18798	2.00 in	4.50 in	0.25 in	70 ft	\$695.00
33223	2.00 in	4.50 in	0.25 in	80 ft	\$825.00
33224	2.00 in	4.50 in	0.25 in	100 ft	\$1,025.00

Note: Maximum continuous length is 450 ft. Call for price and availability.

Electronic Scale Tickets

Standard Features

Hecon® Printers, EL522 & EL516 - 20266

- Triplicate interleaved
- Size (L × W): 7.875 × 4.25 in (200 × 127 mm)
- Order quantity: 500 per package

20266

DATE _____ No. _____

SELLER _____

BUYER _____

ADDRESS _____

CITY _____ STATE _____ ZIP _____

GROSS _____

TARE _____

NET _____

DRIVER ON OFF WEIGHED BY _____

FORM 510

Standard Features

SP2200, SP2000 - 20265

- Triplicate interleaved, perforated and glued on one end
- Size (W × L): 5.5 × 9 in (139.7 × 228.6 mm)
- Order quantity: 500 per package

20265

Limit of Carbon Coverage ↓

ELECTRONIC SCALE TICKET No. _____

DATE _____

SELLER _____

BUYER _____

ADDRESS _____

CITY _____ STATE _____ ZIP _____

COMMODITY _____

PRICE _____

REMARKS _____

DRIVER ON OFF _____

WEIGHER _____

Form ES-4

Standard Features

Rice Lake Scales - 71630 or 105182

- Duplicate or triplicate
- Size (W × L): 4.25 × 7 in (107 × 177.8 mm)
- Attached at 4.25 side
- Order quantity: 500 per package

Custom (duplicate): Add company name (min. order two packs)

Custom (triplicate): Add company name (min. order two packs)

Customer Name: _____

Driver On Driver Off

Customer Signature: _____

RICE LAKE
WEIGHING SYSTEMS
800-472-6703

Standard Features

Blank Scale Ticket - 22263

- Triplicate
- White, canary yellow and pink
- Size (L × W): 5.50 × 4.25 in (140 × 108 mm)
- Attached at 4.25 edge

Custom: Add company name (min. order of 1,000)

Part Number/Price

Part #	Description	Price
20266	Hecon printers, EL522 & EL516, 500/pack	\$110.40
20265	SP2200, SP2000, EL250 & EL500, 500/pack	\$114.00
71630	Rice Lake ticket, two part, 500/pack	\$60.00
105182	Rice Lake ticket, three part, 500/pack white, canary yellow, pink	\$86.50
22263	Blank scale ticket, each	\$25.00 each

Printer Cables



72440



156809 (1m)

156811 (3m)

156815 (5m)

Part Number/Price

Part #	Description	Price
Interface Cables for TicketPress, SP-2200, TM-U295, TM-U590 and Star® Printers		
15547	Blunt end, 25-pin D-sub male RS-232 serial interface cable	\$70.00
15548	25-pin D-sub male to 25-pin D-sub male 20 mA serial interface cable (SP2200 only)	\$70.00
15568	25-pin D-sub male to 25-pin D-sub male RS-232 serial interface cable	\$70.00
Consult	Custom 20 mA/RS-232 serial interface cable	\$95.00
Interface Cables for I-Class		
15547	Blunt end, 25-pin D-sub male RS-232 serial interface cable	\$70.00
Consult	Custom RS-232 interface cable	\$95.00
Interface Cables for Desktops, GoDEX Models, Zebra, E-4203 and M-4206		
41276	DB9 male RS-232 cable to blunt end	\$77.00
Straight Cable		
70056	DB9 male to DB9 female	\$40.00
50749	DB9 female to DB9 female	\$60.00
41279	DB25 male to DB9 male	\$70.00
72440	DB25 male to DB9 female	\$67.00
Null Modem Cable		
66535	DB9F to DB9 female, Null modem	\$46.00
64794	DB9 male to DB9 female	\$69.00
USB Cable		
79074	USB-A (male) to USB-B (male) cable, 6 ft	\$35.00
153603	USB to nine-pin male RS-232 adapter	\$105.00
156806	USB-A (male) to USB-A (male) cable, 1 m	\$35.00
156807	USB-A (male) to USB-A (male) cable, 3 m	\$50.00
156808	USB-A (male) to USB-A (male) cable, 5 m	\$60.00
156809	USB-A (male) to USB-B (male) cable, 1 m	\$55.00
156815	USB-A (male) to USB-B (male) cable, 3 m	\$55.00
156811	USB-A (male) to USB-B (male) cable, 5 m	\$70.00
Ethernet Cable/RJ45		
72697	RJ45 to RJ45, 7 ft	\$40.00
78860	RJ45 to RJ45, cross over 7 ft	\$40.00
75594	RJ45 to nine-pin female	\$70.00
156817	RJ45, 1 m	\$35.00
156818	RJ45, 3 m	\$42.00
156821	RJ45, 5 m	\$50.00
Misc. Cables and Adapters		
22436	Blunt end, nine-pin D-sub female	\$70.00
130213	Blunt end DB25 male	\$58.00
165698	Female to male gender changer	\$11.25
119064	Slimline, Null modem gender changer, DB9 female/female	\$12.50
130789	Null modem DB9 M/F	\$14.50



156817 (1m)

156818 (3m)

156821 (5m)

Blunt-end cables interface to: UMC444, UMC555, UMC600, IQ700, IQ plus® 310A, IQ plus® 355, IQ plus® 390-DC, IQ plus® 510, IQ plus® 590-DC, IQ plus® 710, IQ plus® 800, and IQ plus® 810, 520 and 920i®

Custom cables are designed to interface with your specific equipment. Please specify equipment model number and connector type. Standard cable length is 5 ft.

Static Brushes



Part #	Staticmaster Part #	Description	Price
76669	1C200	Static brush 1 in	\$140.00
76670	1C200R	Replacement cartridge	\$90.00



Part #	Staticmaster Part #	Description	Price
76671	3C500	Static brush 3 in	\$210.00
76672	3C500R	Replacement cartridge	\$145.00

Ionizing Strips



Part #	Staticmaster Part #	Description	Price
76677	1U400	Ionizing unit 1 x 1 in	\$250.00
76678	1U200	Ionizing unit 1 x 1 in	\$150.00
76676	2U500	Ionizing unit 1 x 3 in	\$250.00

Ionizing Strip Accessories

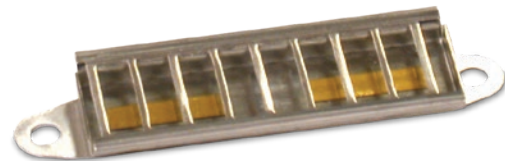

Part #	Staticmaster Part #	Description	Price
76679	BF1	Ionizer positioner	\$73.00
76680	BF2	Ionizer positioner only - C bracket	\$105.00

Desiccants



Standard Features

- Packets
- Bagged desiccants to protect your enclosed electronic components from moisture and humidity
- Useful in junction boxes, indicators and all scale electronics

Part Number/Price

Part #	Description	Price
16038	Mini Pax® 7 g	\$1.22
16039	NatraSorb® 20 g	\$2.23
92240	Silica gel 1 unit pkg 3 g	\$1.17

Industrial Corrosion Inhibitor



Standard Features

- Special chemical combination provides superior protection
- Protects 5 cubic ft/1.4 cubic m of enclosure volume for approximately one year
- Dimensions: (W x H) 2.5 x 1.5 in (64 x 38 mm)

Part Number/Price

Part #	Description	Price
16037	Corrosion inhibitor	\$42.00

Crimper and Lead Seals



Part Number/Price

Part #	Description	Price
21111	Crimper and two die blanks	\$148.00
15318	Crimper die blank (replacements)	\$64.00
15317	100 seals/pkg	\$53.00

Standard Features

Crimper

- 5.0 in (127 mm) seal press with two 0.5 in (13 mm) engraving dies
- Chrome finish
- Maximum number of characters that can be engraved on die is 9
- Compound leverage
- Quick delivery on custom dies

Lead Seals

- Heavy-duty seal with galvanized steel wire
- Length 16.0 in (406 mm)

Static Control Table Mat and Floor Mat



An absolute must for every workbench, this kit includes a 3-layer 2 × 4 ft table mat, 4 × 6 ft floor mat, ground cord and adjustable wrist strap. Designed specifically for energized circuit work, the static control table and floor mat provide superior protection against ESD.

Part Number/Price

Part #	Description	Price
34265	Static control table mat and floor mat	\$900.00

Static Control Wrist Strap



The single most important personal accessory for protecting ESD sensitive components and circuits, this wrist strap protects against charges from the body. The wrist strap consists of a comfortable elastic cuff or band and a detachable conductive cord for grounding the wrist band.

Part Number/Price

Part #	Description	Price
34263	Static control wrist strap	\$58.00

Static Shielding Bags



This static shield bag offers total ESD protection, whether you're transporting ESD-susceptible products across the room or across the country. The outer layer of the bag consists of an abrasion-resistant polyester, while the antistatic polyethylene inner layer retards triboelectric static charging from inside the bag.

Part Number/Price

Part #	Description	Price
16150	Static shielding bags, 8 × 10 in	\$1.17 each
16151	Static shielding bags, 12 × 18 in	\$3.45 each

Static-Safe Service Kit



Standard Features

- Eliminates static for safe board replacement
- Connects a field service technician and the static-safe work surface to the same ground point
- Harmlessly drains static charges from the body and from any conductive objects placed on the mat
- Folds into a compact unit for transport and storage

Part Number/Price

Part #	Description	Price
32818	Static-safe service kit	\$206.00

Rice Lake's Scale Technician Kits

Take Rice Lake's commitment to customer service into the field. Rice Lake's Scale Technician Kit has everything you need in one convenient backpack to troubleshoot and repair wherever you are.

PN 166205

Technician Tool Kit \$1,050.00

- Rice Lake backpack
- Simulator with vernier
- Digital volt meter
- Communication Kit



PN 166204

Communication Kit \$135.00

- Cinch sack
- Document Kit
- Six-in-one screwdriver
- Small RLWS screwdriver
- Test LEDs
- USB to serial converter
- DB9M to DB9F straight cable
- DB9F to blunt end cable
- DB25M to blunt end cable
- Female to female DB9 null modem adapter
- Female to male DB9 gender changers
- Null modem adapter
- TCP/IP patch cable
- TCP/IP crossover cable



PN 166203

Document Kit \$10.50

- Pinouts for a DB9 and DB25 cable shows both male and female connectors
- Pinouts and color codes for a patch and crossover Ethernet cable
- Recommended maximum cabling distances of RS-232, 20mA, 485 and Ethernet TCP/IP
- Standard ASCII chart in both decimal and hexadecimal
- Links to website to download latest version of Revolution® and iRev® (on CD)
- Link to freeware terminal program download (PUTTY, Hercules, RealTerm, etc.)
- Load cell color wire chart
- Weigh Modules and Vessel Weighing Handbook PN 43918
- Load Cell and Weigh Module Handbook PN 22054



PN 118432

Small Screwdriver \$3.00

