

# THURMAN

THURMAN®

# Thurman Price Index By Rice Lake Weighing Systems PN

RL PN	SUGG. LIST	PAGE #	RL PN	SUGG. LIST	PAGE #	RL PN	SUGG. LIST	PAGE #
10772	\$15.00	252	TH901P	\$37.00	250	TH923P	\$26.00	248
10993	\$14.00	252	TH902P	\$37.00	250	TH924P	\$28.00	248
15290	\$2.00	NOT SHOWN	TH903P	\$41.00	250	TH926	\$37.00	249
18815	\$15.00	252	TH904P	\$42.00	250	TH927	\$19.00	252
18816	\$17.00	252	TH905P	\$46.00	249	TH928P	\$38.00	248
21912	\$460.00	254	TH907P	\$54.00	250	TH929P	\$29.00	249
21922	\$30.00	249	TH908P	\$74.00	250	TH939P	\$81.00	248
22910	\$29.00	248	TH909P	\$82.00	250	TH945	\$58.00	251
33645	\$42.00	252	TH910	\$82.00	251	TH946P	\$95.00	248
33646	\$37.00	252	TH911	\$82.00	251	TH947	\$259.00	253
33647	\$54.00	254	TH912	\$117.00	251	TH948	\$358.00	253
33648	\$48.00	252	TH913	\$117.00	251	TH950	\$191.00	254
33649	\$38.00	252	TH914	\$75.00	251	TH952SS	\$32.00	254
33650	\$152.00	254	TH915	\$75.00	251	TH954SS	\$40.00	254
33653	\$45.00	254	TH916	\$95.00	249	TH966	\$209.00	254
33654	\$44.00	254	TH917	\$92.00	249	TH970	\$66.00	251
33905	\$241.00	253	TH918	\$214.00	253			
33906	\$214.00	253	TH919	\$304.00	253			
33907	\$358.00	253	TH921	\$189.00	251			
65430	\$150.00	254	TH922P	\$29.00	248			
72192	\$189.00	251						
75115	\$259.00	253						
H644	\$37.00	252						
H648	\$17.00	252						
H697	\$20.00	251						

THURMAN®

\*Item obsolete or discontinued. When remaining stock is depleted, published prices are withdrawn and the item is subject to a special order quote.

XX Call for details.

# Thurman Cross Reference By Equivalent Thurman Number

<b>EQUIV. NEW THURMAN #</b>	<b>EQUIV. OLD THURMAN #</b>	<b>RL PN</b>	<b>EQUIV. NEW THURMAN #</b>	<b>EQUIV. OLD THURMAN #</b>	<b>RL PN</b>	<b>EQUIV. NEW THURMAN #</b>	<b>EQUIV. OLD THURMAN #</b>	<b>RL PN</b>
300181	T-181	TH939P	10004350		TH958SS	10008690Y	T-269	TH918
10000140A		33654	10004480A		TH964SS	10008710A	T-255-1	TH901P
10000170A		TH952SS	10004770A		TH962SS	10012030A	T-251	33649
10000190A		18815	10004810A		TH959SS	10012040A	T-1079-4	TH970
10001450A		18816	10004820A		TH949SS	10012420A	T-125	TH923P
10001520A		TH953SS	10005790A	T-675	TH945	10012700A	T-11	TH914
10001630A		TH954SS	10005800A	T-12-1	TH911	10012770A		22910
10001640A		33653	10005820A	T-270	TH919	10012860A	T-1155-1	TH902P
10002320A	T-14-4	TH930P	10005830A	T-250-1	33646	10012970A	T-47-1	TH942P
10002400A		33651	10005850A	T-12	TH910	10012980A	T-11-1	TH915
SP10002400A		33650	10005860A		33906	10013810A		TH927
10002410A		TH957SS	10005980A	T-1155-2	TH905P	10013950A	T-250	33645
10003020A		TH960SS	10007420A	T-63-1S	TH926	10013960A	T-251-1	33648
10003190A		TH950	10008490A	T-1155-4	TH907P	10014240A	T-125-1	TH924P
10003200A		TH966	10008500A	T-1155-5	TH908P	10014870A		21922
10003220A		21912	10008550A	T-979	TH912	10015960A	T-96	TH928P
10003970A	T-115-2	33907	10008560A	T-979-1	TH913	10017370A	T-197	TH929P
10004080A	T-122-1	TH947	10008590A	T-1155	TH903P	10018420A		65430
10004080Y	T-1626	75115				10019610A	T-14-1	TH935P
10004340A		TH961SS				10021340A		17749
						10022410	T-1053-10	TH921
						10028830A		33652
							10030540A	
							N/A	T-14-2
							N/A	T-14-3
							N/A	T-47
							N/A	T-47-2
							N/A	T-96-1
							N/A	T-96-2
							N/A	T-181-1
							N/A	T-191
							N/A	T-192
							N/A	T-197-1
							N/A	T-255
							N/A	T-255-2
							N/A	T-1155-3
							N/A	T-1155-6



# Individual Thurman Scale Parts

## Pivots

RL PN	DESCRIPTION	THURMAN NEW #	SUGG. LIST
TH923P	Equiv. Thurman no. T-125 Equiv. new Thurman no. 10012420A Size: 3/8 in x 3/8 in x 2 3/4 in long Pivot	<b>65869</b>	\$26.00
TH924P	Equiv. Thurman no. T-125-1 Equiv. new Thurman no. 10014240A Size: 3/8 in x 3/8 in x 3 3/4 in long Pivot		\$28.00
TH922P	Equiv. Thurman no. T-47-2 Size: 1/2 in x 1/2 in x 2 1/4 in long Pivot		\$29.00
22910	Equiv. Thurman no. 10012770A Size: 1/2 in x 1/2 in x 2 3/4 in long Pivot	<b>65879</b>	\$29.00
TH928P	Equiv. Thurman no. T-96 Equiv. new Thurman no. 10015960A Size: 5/8 in x 5/8 in x 4 in long Pivot	<b>66076</b>	\$38.00
TH939P	Equiv. Thurman no. T-181 Equiv. new Thurman no. 300181 Size: 1 1/8 in x 1 1/8 in x 7 3/4 in long Pivot	<b>72189</b>	\$81.00
TH946P	Equiv. Thurman no. T-181-1 Size: 1 1/8 in x 1 1/8 in x 9 in l Pivot	<b>66504</b>	\$95.00
TH929P	Equiv. Thurman no. T-197 Equiv. new Thurman no. 10017370A Size: 3/8 in x 7/8 in x 1 in long Pivot	66295	\$29.00

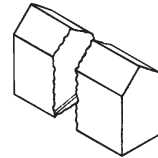
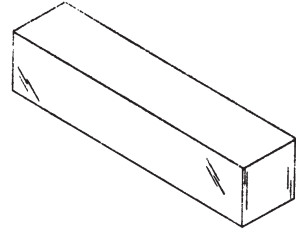

**THURMAN®**

# Individual Thurman Scale Parts

Pivots (Cont.)

RL PN	DESCRIPTION	THURMAN NEW #	SUGG. LIST
TH901P	Equiv. Thurman no. T-255-1 Equiv. new Thurman no. 10008710A Size: 1/2 in x 1 in x 1 7/8 in long With spot drill Pivot	<b>65647</b>	\$37.00
TH904P	Equiv. Thurman no. T-255 Size: 1/2 in x 1 in x 3 3/4 in long With spot drill Pivot		\$42.00
TH902P	Equiv. Thurman no. T-1155-1 Equiv. new Thurman no. 10012860A Size: 1/2 in x 1 in x 2 1/4 in long Pivot	<b>65889</b>	\$37.00
TH903P	Equiv. Thurman no. T-1155 Equiv. new Thurman no. 10008590A Size: 1/2 in x 1 in x 3 3/4 in long Pivot	<b>65628</b>	\$41.00
TH905P	Equiv. Thurman no. T-1155-2 Equiv. new Thurman no. 10005980A Size: 1/2 in x 1 in x 5 11/16 in long Pivot	<b>65319</b>	\$46.00
TH907P	Equiv. Thurman no. T-1155-4 Equiv. new Thurman no. 10008490A Size: 1/2 in x 1 in x 7 3/4 in long Pivot	<b>65610</b>	\$54.00
TH908P	Equiv. Thurman no. T-1155-5 Equiv. new Thurman no. 10008500A Size: 1/2 in x 1 in x 11 in long Pivot	<b>65613</b>	\$74.00
TH909P	Equiv. Thurman no. T-1155-6 Size: 1/2 in x 1 in x 12 3/16 in long Pivot		\$82.00

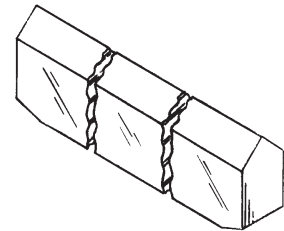
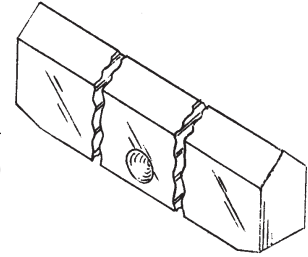

**THURMAN®**

# Individual Thurman Scale Parts

## Bearings

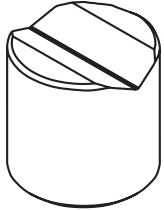
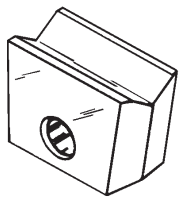
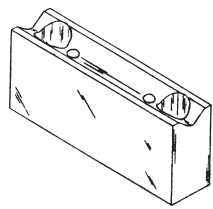
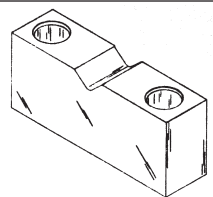
RL PN	DESCRIPTION	THURMAN NEW #	SUGG. LIST	
21922	Equiv. Thurman no. Equiv. new Thurman no. 10014870A Size: 1 in dia x 1 in Bearing	65950	\$30.00	
TH926	Equiv. Thurman no. T-63-1S Size: 1/2 in x 3/4 in x 1 in long Bearing, fits casting no. T-339		\$37.00	
TH916	Equiv. Thurman no. T-192 Equiv. new Thurman no. 10007420A Size: 1 1/8 in x 2 in x 4 3/4 in long Bearing, truck scale With pins		\$95.00	
TH917	Equiv. Thurman no. T-191 Size: 1 1/8 in x 2 in x 4 3/4 in long Bearing, truck scale		\$92.00	

**THURMAN®**

# Individual Thurman Scale Parts

Bearings (Cont.)

RL PN	DESCRIPTION NEW #	THURMAN	SUGG. LIST
TH914	Equiv. Thurman no. T-11 10012700A Size: 2 1/8 in x 1 in x 3 5/8 in long Bearing, load with 2 dowel holes And a tapered shank Use roll pin no. 15290	<b>65874</b>	\$75.00
TH910	Equiv. Thurman no. T-12 Equiv. new Thurman no. 10005850A Size: 2 in x 1 in x 5 5/8 in long Bearing, load with 2 dowel holes And a tapered shank Use roll pin no. 15290	<b>65298</b>	\$82.00
TH912	Equiv. Thurman no. T-979 Equiv. new Thurman no. 10008550A Size: 2 in x 1 1/4 in x 7 9/16 in long Bearing, load with 2 dowel holes And a tapered shank Use roll pin no. 15290	<b>65621</b>	\$117.00
TH921	Equiv. Thurman no. T-1053-10 Equiv. new Thurman no. 10022410A Size: 1 1/4 in x 2 in x 10 3/4 in long Bearing, load with 2 dowel holes And a straight shank Use roll pin no. 15290	<b>66413a</b>	\$189.00
TH945	Equiv. Thurman no. T-675 Equiv. new Thurman no. 10005790A Size: 1 1/2 in x 1 in x 3 1/4 in long Rocker use with TH911 & TH915	<b>65280</b>	\$58.00
TH970	Equiv. Thurman no. T-1079-4 Equiv. new Thurman no. 10012040A Size: 1 1/2 in x 1 3/4 in x 6 in Rocker for TH913	<b>65856</b>	\$66.00
TH915	Equiv. Thurman no. T-11-1 Equiv. new Thurman no. 10012980A Size: 2 1/8 in x 1 in x 3 5/8 in long Bearing, fulcrum with straight shank Shank size: 11/16 in dia	<b>65903</b>	\$75.00
TH911	Equiv. Thurman no. T-12-1 Equiv. new Thurman no. 10005800A Size: 2 in x 1 in x 5 5/8 in long Bearing, fulcrum with straight shank Shank size: 11/16 in dia	<b>65282</b>	\$82.00
TH913	Equiv. Thurman no. T-979-1 Equiv. new Thurman no. 10008560A Size: 2 in x 1 1/4 in x 7 9/16 in long Bearing, fulcrum with straight shank Shank size: 11/16 in dia	<b>65624</b>	\$117.00
72192	Equiv. Thurman no. Size: 2 in x 1 in x 10 3/4 in no holes, fulcrum	<b>66401</b>	\$189.00

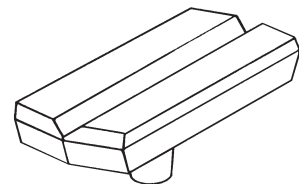
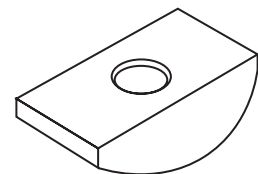
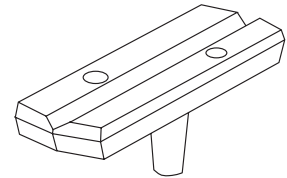

THURMAN®

# Individual Thurman Scale Parts

Miscellaneous Diameter Balls, Plates & Stands

RL PN	DESCRIPTION	THURMAN NEW #	SUGG. LIST
18815	Equiv. Thurman no. 10000190A size: 5/8 in dia Ball, model 3300	<b>64346</b>	\$15.00
10993	Equiv. Howe no. n/a Size: 3/4 in dia Ball (steel)		\$14.00
18816	Equiv. Thurman no. 10001450A size: 7/8 in dia Ball, model 3500		\$17.00
10772	Equiv. Howe no. n/a Size: 1 in dia Ball (steel)		\$15.00
H648	Equiv. Howe no. 42035848 Size: 1 5/16 in dia Ball (steel) Models: 57, type 54, Floor scales etc.		\$17.00
TH927	Equiv. Thurman no. Equiv. new Thurman no. 10013810A Size: 1 7/16 in dia Ball, warehouse scale Model 3300, suspension	<b>65929</b>	\$19.00
H697	Equiv. Howe no. Size: 1 1/2 in dia Ball (steel)	<b>64684</b>	\$20.00
33645	Equiv. Thurman no. T-250 Equiv. new Thurman no. 10013950A size: 2 in dia Ball, truck scale	<b>65930</b>	\$42.00
H644	Equiv. Howe no. 42102471 Size: 2 3/8 in dia Ball (cast)		\$37.00
33646	Equiv. Thurman no. T-250-1 Equiv. new Thurman no. 10005830A size: 2 1/2 in dia Ball, truck scale	<b>65294</b>	\$37.00
33649	Equiv. Thurman no. T-251 Equiv. new Thurman no. 10012030A size: 3 in dia Ball, truck scale	<b>65855</b>	\$38.00
33648	Equiv. Thurman no. T-251-1 Equiv. new Thurman no. 10013960A size: 3 1/2 in dia Ball, truck scale	<b>65931</b>	\$48.00

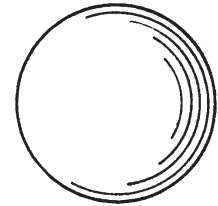



**THURMAN®**

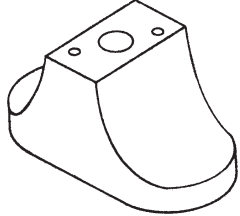
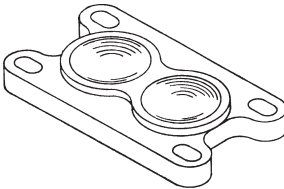

# Individual Thurman Scale Parts

Miscellaneous Diameter Balls, Plates & Stands (Cont.)

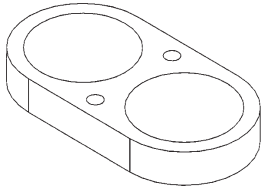
RL PN	DESCRIPTION	THURMAN NEW #	SUGG. LIST	
TH919	Equiv. Thurman no. T-270 Equiv. new Thurman no. 10005820A Size: 4 in x 4 in x 8 in long Ball stand, truck scale	<b>65293</b>	\$304.00	
TH948	Equiv. Thurman no. T-115 Equiv. new Thurman no. 10030540A Size: 5 in x 7 3/4 in x 11 in long Ball stand, 75-ton truck scale	<b>72236</b>	\$358.00	
33907	Equiv. Thurman no. T115-2 Equiv. new Thurman no. 10003970A Size: 5 in x 6 in x 11 in long Ball stand, class III & IV	<b>64960</b>	\$358.00	
TH918	Equiv. Thurman no. T-269, T1556 Equiv. new Thurman no. 10008690Y Size: 6 1/4 in x 1 1/4 in x 11 in long Ball plate, truck scale	<b>65643</b>	\$214.00	
TH947	Equiv. Thurman no. T-122-1 Equiv. new Thurman no. 10004080Y Size: 13 in x 2 1/4 in x 12 in long Ball plate, 75-ton truck scale		\$259.00	
75115	Equiv. Thurman no. T1626 Equiv. new Thurman no. 10004080Y Size: 8 in x 1 1/2 in x 13 in long Ball plate	<b>72236</b>	\$259.00	
33906	Equiv. Thurman no. n/a Equiv. new Thurman no. 10005860A Size: 4 1/4 in x 1 1/8 in x 8 1/4 in long Ball plate, model 8160 class I & II		\$214.00	
33905	Equiv. Thurman no. n/a Equiv. new Thurman no. 10048650A Size: 5 in x 1 1/2 in x 11 in long Ball plate, model 8160 class III & IV		\$241.00	

**THURMAN®**

# Individual Thurman Scale Parts

## Miscellaneous Parts

RL PN	DESCRIPTION	THURMAN NEW #	SUGG. LIST
TH950	Equiv. Thurman no. 10003190A size: 2 3/8 in dia x 14 in 50,000 And 60,000 lb Trunnion, electronic truck scales	<b>64812</b>	\$191.00
TH966	Equiv. Thurman no. 10003200A size: 2 3/4 in dia x 14 in 100,000 lb Trunnion, electronic truck scales	<b>64814</b>	\$209.00
65430	Equiv. Thurman no. 10018420A size: 1 1/4 in dia x 7 in inside dimensions Link, electronic truck scales	<b>66347</b>	\$150.00
21912	Equiv. Thurman no. 10003220A Size: 1 3/8 in dia x 7 3/4 in inside dimensions Link, electronic truck scales		\$460.00
33654	Equiv. Thurman no. 10000140A Size: A. 3/4 in C. 1/2 in B. 1 1/8 in D. 1/2 in-20 THrd Load cup Model 3500 1,000-5,000 lb, 1500/1502, 3300/3301 1,000-4,000 lb		\$44.00
33653	Equiv. Thurman no. 10001640A Size: A. 1 1/8 in C. 3/4 in B. 1 1/2 in D. 3/4 in-16 THrd Load cup Model 3510/3520 10,000 and 20,000 lb, 1500/1503, 5,000 and 10,000 lb	<b>64554</b>	\$45.00
33650	Equiv. Thurman no. Sp 10002400a Size: A. 1 3/4 in C. 13/16 in B. 2 13/16 in D. 1 in-14 THrd Load cup		\$152.00
33647	Equiv. Thurman no. Size: A. 1 3/4 in C. 1/2 in B. 2 3/4 in D. 1/2 in-20 THrd Load cup		\$54.00
TH952SS	Equiv. Thurman no. 10000170A Size: 0.783 in dia x 1/2 in Bearing socket		\$32.00
TH954SS	Equiv. Thurman no. 10001630A Size: 1.127 in dia x 3/4 in Bearing socket		\$40.00

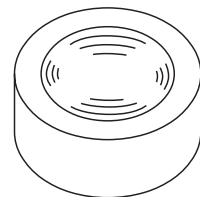
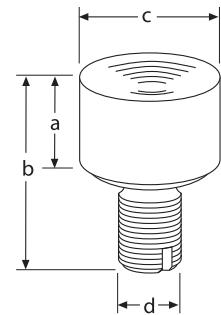
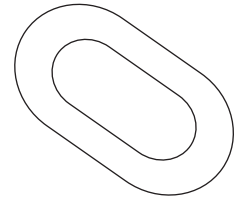
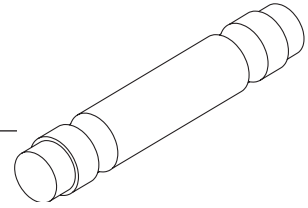

# THURMAN KITS

THURMAN®

# Thurman Kit Price Index By Rice Lake PN

RL PN	SUGG. LIST	PAGE #	RL PN	SUGG. LIST	PAGE #	RL PN	SUGG. LIST	PAGE #
34323	\$2,587.00	258	TH302K	\$2,056.00	261	TH309K	\$5,124.00	263
34324	\$2,952.00	258	TH303K	\$2,050.00	261	TH310K	\$4,909.00	XX
34325	\$3,093.00	258	TH304K	\$2,468.00	262	TH312K	\$7,337.00	XX
34326	\$3,093.00	259	TH306K	\$4,239.00	262	TH313K	\$5,693.00	XX
34327	\$3,837.00	259	TH307K	\$4,099.00	263	TH314K	\$2,910.00	262
34328	\$4,428.00	259	TH308K	\$4,934.00	263			
34329	\$4,934.00	260						
34330	\$5,592.00	260						
TH301K	\$1,974.00	261						

\*Item obsolete or discontinued. When remaining stock is depleted, published prices are withdrawn and The item is subject to a special order quote.

XX Call for details.

**THURMAN®**

# Mechanical Vehicle Scales

Models 8100 (XTCP), 8110 and 8120, (STCP), 8130 and 8140 (SAM)

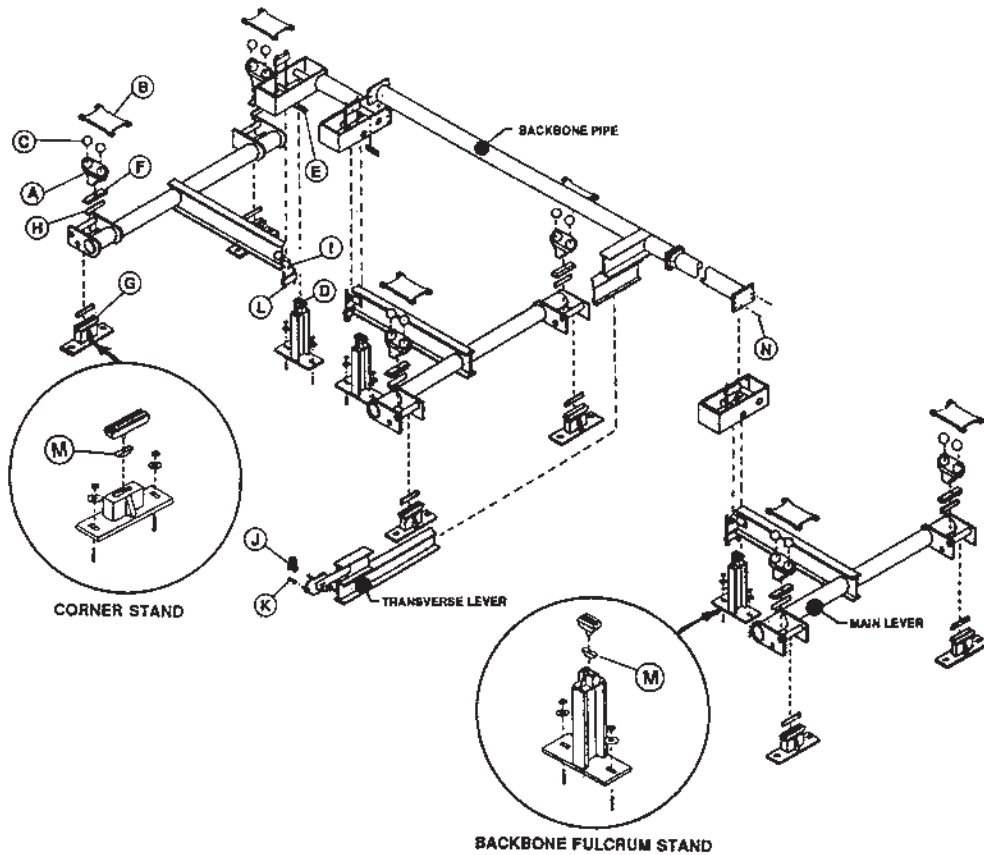

**THURMAN®**

## Model 8160 Electro-mechanical

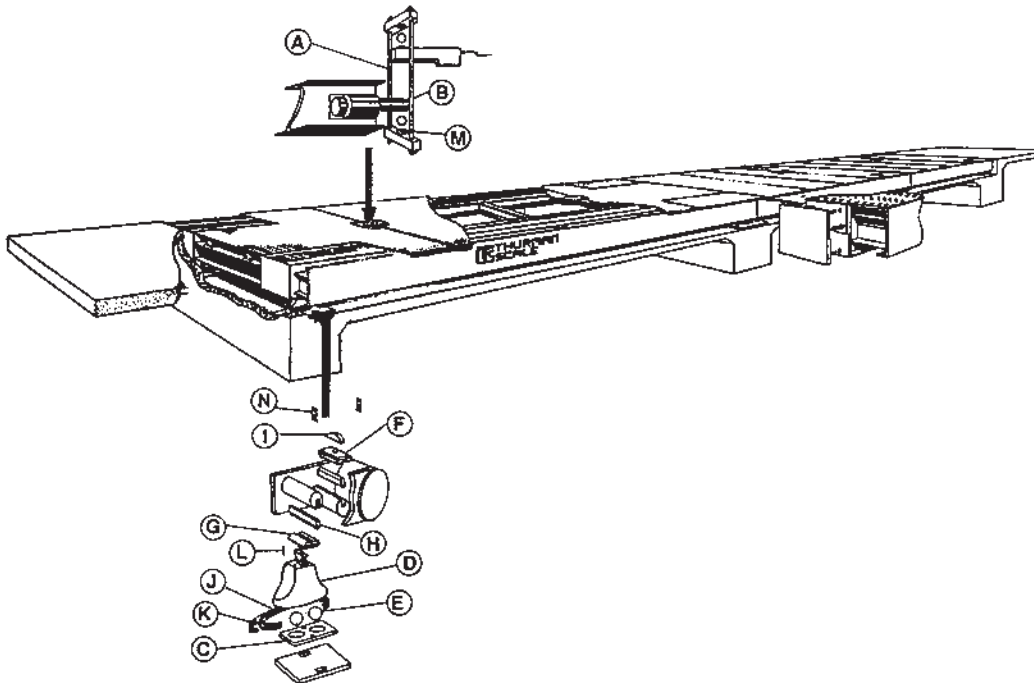

# Truck Scale

## Kit No. 34323 Thurman PN 96955

Pivot and Bearing Kit 2-Section, 1982 and Newer, Class III and IV  
 Model 8100 XTCP  
 Models 8110 and 8120 STCP  
 Models 8130 and 8140 SAM

QTY	RL PN	EQUIV. THURMAN #	DESCRIPTION
8.....	TH907P .....	T-1155-4, 10008490A	Pivot, load and fulcrum
4.....	TH912.....	T-979, 10008550A.....	Bearing, load
4.....	TH913.....	T-979-1, 10008560A...	Bearing and fulcrum
4.....	TH903P .....	T-1155, 10008590A....	Pivot, torque tube load and fulcrum
4.....	TH970.....	T-1079-4, 10012040D	Rocker
2.....	TH915.....	T-11-1, 10012980A....	Bearing, torque tube fulcrum
2.....	TH917.....	T-191 .....	Bearing, torque tube load
2.....	TH916.....	T-192 .....	Bearing, main lever, tip
2.....	TH901P .....	T255-1, 10008710A ...	Pivot, main lever tip
1.....	22910 .....	10012770A.....	Pivot, transverse lever tip
8.....	15290 .....	n/a.....	Pin, spring 3/8 in x 1 1/2 in

**\$2,587.00** Suggested list/80 lb shipping weight

## Kit No. 34324 Thurman PN 96807

Suspension Kit, 2-Section, old scale use kit TH914K, 1982 and Newer Scale Use Class III and IV  
 Model 8100 XTCP  
 Models 8110 and 8120 STCP  
 Models 8130 and 8140 SAM

QTY	RL PN	EQUIV. THURMAN #	DESCRIPTION
8.....	33649 .....	T251, 10012030a .....	Ball 3 inch
4.....	33907 .....	T-115-2, 10003970a...	Tee block (ball stand) 6 inch high
4.....	75115 .....	T-1626, 10004080y ....	Ball plate, <i>check height of tee block</i>

**\$2,952.00** Suggested list/350 lb shipping weight

## Kit No. 34325 Thurman PN 34325

Pivot and Bearings Kit, 3-Section, 1982 and Newer Class I and II  
 Model 8100 XTCP  
 Models 8110 and 8120 STCP  
 Models 8130 and 8140 SAM

QTY	RL PN	EQUIV. THURMAN #	DESCRIPTION
12.....	TH905P .....	T-1155-2, 10005980A	Pivot, load and fulcrum
6.....	TH910.....	T-12, 10005850A.....	Bearing, load
6.....	TH911 .....	T-12-1, 10005800A....	Bearing, fulcrum
6.....	TH903P .....	T1155, 10008590A....	Pivot, torque tube load and fulcrum
6.....	TH945.....	T675, 10005790A.....	Rocker
3.....	TH915.....	T11-1, 10012980A .....	Bearing, torque tube fulcrum
3.....	TH917.....	T191 .....	Bearing, torque tube load
3.....	TH916.....	T192 .....	Bearing, main lever tip
3.....	TH901P .....	T255-1, 1008710A .....	Pivot, main lever tip
1.....	22910 .....	10012770A.....	Pivot, torque tube tip
12.....	15290 .....	n/a.....	Pin, spring 3/8 in x 1 1/2 in

**\$3,093.00** Suggested list/90 lb shipping weight

THURMAN®

# Truck Scale

## Kit No. 34326 Thurman PN 65811

Suspension Kit, 1982 and Newer, 3-Sections, Class I and II  
 Model 8100 XTCP  
 Models 8110 and 8120 STCP  
 Models 8130 and 8140 SAM

QTY	RL PN	EQUIV. THURMAN #	DESCRIPTION
12.....	33646 .....	T-250-1, 10005830A...	Balls, 2 1/2 inch
6.....	TH918.....	T-269, 10008690a .....	Ball plate
6.....	TH919.....	T-270, 10005820a .....	Tee block (ball stand)

**\$3,093.00** Suggested list/156 lb shipping weight

## Kit No. 34327 Thurman PN 96956

Pivot and Bearing Kit, 3-Sections, 1982 and Newer Class III and IV  
 Model 8100 XTCD  
 Models 8110 and 8120 STCP  
 Models 8130 and 8140 SAM

QTY	RL PN	EQUIV. THURMAN #	DESCRIPTION
12.....	TH907P .....	T115, 10008490A.....	Pivot, load and fulcrum
6.....	TH912.....	T979, 10008550a .....	Bearing, load
6.....	TH913.....	T-979-1, 10008560A...	Bearing, fulcrum
6.....	TH903P .....	TH1155, 10008590A ..	Pivot, torque tube load and fulcrum
6.....	TH970.....	T1079-4, 10012040A ..	Rocker
3.....	TH915.....	T11-1, 100012980A ...	Bearing, torque tube fulcrum
3.....	TH917.....	T191 .....	Bearing, torque tube load
3.....	TH916.....	T192 .....	Bearing, main lever tip
3.....	TH901P .....	T255-1, 10008710A ...	Pivot, main lever tip
1.....	22910 .....	10012770A.....	Pivot, torque tube tip
12.....	15290 .....	n/a.....	Pin, spring 3/8 in x 1 1/2 in

**\$3,837.00** Suggested list/105 lb shipping weight

## Kit No. 34328 Thurman PN 96809

Suspension Kit, 3-Sections, 1982 and Newer Class III and IV  
 Model 8100 XTCD  
 Models 8110 and 8120 STCP  
 Models 8130 and 8140 SAM

QTY	RL PN	EQUIV. THURMAN #	DESCRIPTION
12.....	33649 .....	T251, 10012030A.....	Balls, 3 inch
6.....	33907 .....	T-115-2, 10003970A...	Tee block (ball stand) 6 inch high
6.....	75115 .....	T1626, 10004080A.....	Ball plate, <i>check height of tee block</i>

**\$4,428.00** Suggested list/527 lb shipping weight



# Truck Scale

## Kit No. 34329 Thurman PN 96957

Pivot and Bearings Kit, 4-Sections, 1982 and Newer, Class III and IV

Model 8100 XTCD

Models 8110 and 8120 STCP

Models 8130 and 8140 SAM

QTY	RL PN	EQUIV. THURMAN #	DESCRIPTION
16.....	TH907P .....	T-1155-4, 10008490A	Pivot, load and fulcrum
8.....	TH912.....	T-979, 10008550A.....	Bearing, load
8.....	TH913.....	T-979-1, 10008560A...	Bearing, fulcrum
8.....	TH903P .....	T1155, 10008590A.....	Pivot, torque tube load and fulcrum
8.....	TH970.....	T1079-4, 100112040A	Rocker
4.....	TH915.....	T11-1, 10012980A .....	Bearing, torque tube fulcrum
4.....	TH917.....	T191 .....	Bearing, torque tube load
4.....	TH916.....	T192 .....	Bearing, main lever tip
4.....	TH901P .....	T255-1, 10008710A ...	Pivot, main lever tip
1.....	22910 .....	10012770A.....	Pivot, torque tube tip
16.....	15290 .....	n/a.....	Pin, spring 3/8 in x 1 1/2 in

**\$4,934.00** Suggested list/120 lb shipping weight

## Kit No. 34330 Thurman PN 96808

Suspension Kit, 4-Sections, 1981 and Older Use Kit TH313K, 1982 and Newer Use This Kit, 34330

Model 8100 XTCD

Models 8110 and 8120 STCP

Models 8130 and 8140 SAM

QTY	RL PN	EQUIV. THURMAN #	DESCRIPTION
16.....	33649 .....	T251, 10012030a .....	Balls, 3 inch
8.....	33907 .....	T-115-2, 10003970a...	Tee block (ball stand) 6 inch high
8.....	75115 .....	T1626, 10004080a.....	Ball plate, <i>check height of tee block</i>

**\$5,592.00** Suggested list/700 lb shipping weight

THURMAN®



# Truck Scale

## Kit No. TH301K

Pivot and Bearing Kit (Does Not Fit Side Arm), 2-Section, 27-Ton Light Duty

QTY	RL PN	EQUIV. THURMAN #	DESCRIPTION
4	TH914	T-11	Bearing, load
4	TH945	T675, 10005790A	Rocker
6	TH915	T-11-1	Bearing, fulcrum
12	TH904P	T-255	Pivot, load and fulcrum
2	TH916	T-192	Bearing, main lever tip
2	TH917	T-191	Bearing, torque tube load
2	TH901P	T-255-1	Pivot, tip
1	22910	10012770A	Pivot, transverse tip
16	15290	n/a	Roll pin

**\$1,974.00** Suggested list/45 lb shipping weight

## Kit No. TH302K Thurman PN 72805

Pivot and Bearing Kit (Does Not Fit Side Arm), 2-Section, 27- and 37-Ton Heavy Duty Truck Scale

QTY	RL PN	EQUIV. THURMAN #	DESCRIPTION
4	TH910	T-12	Bearing, load
4	TH911	T-12-1	Bearing, fulcrum
4	TH945	T675, 10005790a	Rocker
8	TH905P	T-1155-2	Pivot, load and fulcrum
2	TH916	T-192	Bearing, main lever tip
2	TH917	T-191	Bearing, torque tube load
2	TH915	T-11-1	Bearing, torque tube fulcrum
2	TH901P	T-255-1	Pivot, tip
2	TH902P	T-1155-1	Pivot, torque tube load
2	TH904P	T-255	Pivot, torque tube fulcrum
1	TH922P	T-47-2	Pivot, transverse tip
8	15290	n/a	Roll pin

**\$2,056.00** Suggested list/53 lb shipping weight

## Kit No. TH303K Thurman PN 65810

Suspension Kit, 2-Section, 27- and 37-Ton Light and Heavy Duty Truck Scales

QTY	RL PN	EQUIV. THURMAN #	DESCRIPTION
8	33646	T-250-1	Ball, 2 1/2 in
4	TH918	T-269	Ball plate
4	TH919	T-270	Tee block (ball stand)

**\$2,050.00** Suggested list/156 lb shipping weight

**THURMAN®**

# Truck Scale

## Kit No. TH304K

Pivot & Bearing Kit, 2-Section, 52-Ton Truck Scale

QTY	RL PN	EQUIV. THURMAN #	DESCRIPTION
4	TH913	T-979-1	Bearing, fulcrum
4	TH912	T-979	Bearing, load
4	TH970	T1079-4, 10012040A	Rocker
8	TH907P	T-1155-4	Pivot, load & fulcrum
2	TH911	T-12-1	Bearing, torque tube fulcrum
2	TH916	T-192	Bearing, main lever tip
2	TH917	T-191	Bearing, torque tube load
2	TH905P	T-1155-2	Pivot, torque tube fulcrum
2	TH903P	T-1155	Pivot, torque tube load
2	TH901P	T-255-1	Pivot, main lever tip
1	22910	10012770A	Pivot, transverse tip
8	15290	n/a	Roll pin

**\$2,468.00** Suggested list/72 lb shipping weight

## Kit No. TH314K

Suspension Kit For 1981 and Older Use TH314K, Newer Scales Use Kit 34324

QTY	RL PN	EQUIV. THURMAN #	DESCRIPTION
8	33649	T-251	Ball, 3 in
4	TH947	T-122-1	Ball plate, <i>check height of tee block</i>
4	TH948	T-115	Tee block (ball stand) 7 3/4 in high

**\$2,910.00** Suggested list/390 lb shipping weight

## Kit No. TH306K

Pivot & Bearing Kit, 4-Section, 52- & 62-Ton Truck Scale, Class I and II  
Model 8100 XTCD

Models 8110 & 8120 STCP

Models 8130 & 8140 SAM

QTY	RL PN	EQUIV. THURMAN #	DESCRIPTION
8	TH910	T-12	Bearing, load
8	TH911	T-12-1	Bearing, fulcrum
12	TH945	T675, 10005790A	Rocker
16	TH905P	T-1155-2	Pivot, load & fulcrum
4	TH916	T-192	Bearing, lower tip
4	TH917	T-191	Bearing, torque tube load
4	TH901P	T-255-1	Pivot, tip
4	TH902P	T-1155-1	Pivot, torque tube load
4	TH915	T-11-1	Bearing, torque tube fulcrum
4	TH904P	T-255	Pivot, torque tube fulcrum
1	22910	10012770A	Pivot, transverse tip
16	15290	n/a	Roll pin

**\$4,239.00** Suggested list/100 lb shipping weight

# Truck Scale

## Kit No. TH307K Thurman PN 65812

Suspension Kit For TH306K

QTY	RL PN	EQUIV. THURMAN #	DESCRIPTION
16.....	33646 .....	T-250-1 .....	Ball, 2 1/2 in
8.....	TH918.....	T-269 .....	Ball plate
8.....	TH919.....	T-270 .....	Tee block (ball stand)

**\$4,099.00** Suggested list/312 lb shipping weight

## Kit No. TH308K

Pivot & Bearing Kit, 5-Section, 52- & 62-Ton Truck Scale

QTY	RL PN	EQUIV. THURMAN #	DESCRIPTION
10.....	TH910.....	T-12 .....	Bearing, load
10.....	TH911.....	T-12-1 .....	Bearing, fulcrum
10.....	TH945.....	T-675, 10005790A.....	Rocker
20.....	TH905P .....	T-1155-2.....	Pivot, load & fulcrum
5.....	TH916.....	T-192 .....	Bearing, lower tip
5.....	TH917.....	T-191 .....	Bearing, torque tube load
5.....	TH901P .....	T-255-1.....	Pivot, tip
5.....	TH915.....	T-11-1.....	Bearing, torque tube fulcrum
5.....	TH902P .....	T-1155-1.....	Pivot, torque tube load & fulcrum
1.....	22910 .....	10012770A.....	Pivot, transverse tip
5.....	TH904P .....	T-255 .....	Pivot, torque tube fulcrum
20.....	15290 .....	n/a.....	Roll pin

**\$4,934.00** Suggested list/125 lb shipping weight

## Kit No. TH309K

Suspension Kit For TH308K

QTY	RL PN	EQUIV. THURMAN #	DESCRIPTION
20.....	33646 .....	T-250-1 .....	Ball, 2 1/2 in
10.....	TH918.....	T-269 .....	Ball plate
10.....	TH919.....	T-270 .....	Tee block (ball stand)

**\$5,124.00** Suggested list/390 lb shipping weight

**THURMAN®**

# Truck Scale

## Kit No. TH310K

Pivot & Bearing Kit, 4-Section, 75-Ton Truck Scale

QTY	RL PN	EQUIV. THURMAN #	DESCRIPTION
8.....	TH912.....	T-979.....	Bearing, load
8.....	TH913.....	T-979-1.....	Bearing, fulcrum
8.....	TH970.....	T1079-4, 10012040A.....	rocker
16.....	TH907P.....	T-1155-4.....	Pivot, load & fulcrum
4.....	TH916.....	T-192.....	Bearing, main lever tip
4.....	TH911.....	T-12-1.....	Bearing, torque tube
4.....	TH905P.....	T-1155-2.....	Pivot, torque tube fulcrum
4.....	TH903P.....	T-1155.....	Pivot, torque tube load
4.....	TH901P.....	T-255-1.....	Pivot, main lever tip
4.....	TH917.....	T-191.....	Bearing, torque tube
1.....	22910.....	10012770A.....	Pivot, transverse tip
16.....	15290.....	n/a.....	roll pin

**\$4,909.00** Suggested list/143 lb shipping weight

## Kit No. TH313K

Suspension Kit For TH310K Built Before 1982 For Scales Built After 1982 Use Kit 34330

QTY	RL PN	EQUIV. THURMAN #	DESCRIPTION
8.....	TH947.....	T-122-1.....	Ball plate
8.....	TH948.....	T-115.....	Tee block, 7 3/4 in tall
16.....	33649.....	T-251.....	Ball, 3 in

**\$5,693.00** Suggested list/777 lb shipping weight

## Kit No. TH312K

Straight Lever, 4-Section, 50- & 75-Ton Truck Scale

QTY	RL PN	EQUIV. THURMAN #	DESCRIPTION
40.....	TH914.....	T-11.....	Bearing, load & fulcrum
32.....	TH904P.....	T-255.....	Pivot, load & fulcrum
14.....	TH901P.....	T-255-1.....	Pivot, tip
14.....	TH916.....	T-192.....	Bearing, tip
12.....	TH917.....	T-191.....	Bearing, torque tube
8.....	TH903P.....	T-1155.....	Pivot, extension lever
12.....	TH902P.....	T-1155-1.....	Pivot
1.....	22910.....	10012770A.....	Pivot, tip

**\$7,337.00** Suggested list/172 lb shipping weight

**Call 715-234-9171 For Suspension Parts**

THURMAN®