

160-10-7N

*Low-Profile Digital Athletic Scale
Software Version 11525*

Technical Manual



© Rice Lake Weighing Systems. All rights reserved.

Rice Lake Weighing Systems® is a registered trademark of
Rice Lake Weighing Systems.

All other brand or product names within this publication are trademarks or
registered trademarks of their respective companies.

All information contained within this publication is, to the best of our knowledge, complete and
accurate at the time of publication. Rice Lake Weighing Systems reserves the right to make
changes to the technology, features, specifications and design of the equipment without notice.

The most current version of this publication, software, firmware and all other product
updates can be found on our website:

www.ricelake.com

Revision History

This section tracks and describes the current and previous manual revisions for awareness of major updates and when the updates took place.

Revision	Date	Description
C	August 18, 2022	Established a revision history; formatted content to match other medical manuals; software version 11525

Table i. Revision Letter History



Technical training seminars are available through Rice Lake Weighing Systems. Course descriptions and dates can be viewed at www.ricelake.com/training or obtained by calling 715-234-9171 and asking for the training department.

Contents

1.0 Introduction	1
1.1 FCC Compliance	1
1.2 Safety	2
2.0 Assembly	3
2.1 Unpacking	3
2.1.1 Repacking	3
2.2 Scale Setup	3
2.2.1 Leveling the Scale	3
2.3 Indicator Setup	4
2.3.1 Load Cell Connection	4
2.3.2 Insert Batteries	5
2.3.3 Power Connection	5
3.0 Operation	6
3.1 Key Descriptions	6
3.2 Weighing	7
3.3 Hold/Release Function	7
3.4 Preset Tare	7
3.5 Toggle Tare	7
3.6 Using the Body Mass Index (BMI) Function	8
3.6.1 LB Mode	8
3.6.2 KG Mode	8
3.7 Troubleshooting	9
4.0 Configuration	10
4.1 Setup Mode	10
4.2 Setup Mode Navigation:	10
4.3 General Navigation	10
4.3.1 Change Parameters	10
4.3.2 Enter Numbers	10
4.3.3 Save and Return to Main Menu	11
4.4 User Menu	12
4.5 Configuration Mode	13
4.6 Default Scale	13
4.7 Program Menu	14
4.8 Scale Calibration	15
4.9 Test Menu	16
5.0 Communication	17
5.1 Push-button Keypad Print	17
5.2 Communication Protocols	18
5.2.1 Escape Protocol	18
5.2.2 Maintenance Protocol	19
5.3 USB Connection	20
6.0 Sealing of the Unit	21
6.1 NTEP Regulations	21
6.2 Measurement Canada Regulations	21
7.0 Maintenance	22
7.1 Basic Maintenance	22
7.2 Cleaning	22
8.0 Specifications	23



Rice Lake continually offers web-based video training on a growing selection of product-related topics at no cost. Visit www.ricelake.com/webinars

1.0 Introduction

The 160-10-7N low-profile digital athletic scale is efficiently designed to provide accurate, reliable and repeatable weight measurements. The large, stand-alone indicator can be placed on a table or the floor. It can also be mounted to a wall using the sturdy, built-in bracket. The 160-10-7N low-profile digital athletic scale is an NTEP-certified device that provides the highest possible accuracy when weight is a critical factor.



Manuals, resources and warranties are available from Rice Lake Weighing Systems website at www.ricelake.com/health

1.1 FCC Compliance

United States

This equipment has been tested and found to comply with the limits for a Class A digital device, pursuant to Part 15 of the FCC Rules. These limits are designed to provide reasonable protection against harmful interference when the equipment is operated in a commercial environment. This equipment generates, uses, and can radiate radio frequency energy and, if not installed and used in accordance with the instruction manual, may cause harmful interference to radio communications. Operation of this equipment in a residential area is likely to cause harmful interference in which case the user will be required to correct the interference at his own expense.

Canada

This digital apparatus does not exceed the Class A limits for radio noise emissions from digital apparatus set out in the Radio Interference Regulations of the Canadian Department of Communications.

Le présent appareil numérique n'émet pas de bruits radioélectriques dépassant les limites applicables aux appareils numériques de la Class A prescrites dans le Règlement sur le brouillage radioélectrique édicté par le ministère des Communications du Canada.

1.2 Safety

Safety Definitions:



Indicates an imminently hazardous situation that, if not avoided, will result in death or serious injury. Includes hazards that are exposed when guards are removed.



Indicates a potentially hazardous situation that, if not avoided, could result in serious injury or death. Includes hazards that are exposed when guards are removed.



Indicates a potentially hazardous situation that, if not avoided, could result in minor or moderate injury.



Indicates information about procedures that, if not observed, could result in damage to equipment or corruption to and loss of data.

General Safety



Do not operate or work on this equipment unless this manual has been read and all instructions are understood. Failure to follow the instructions or heed the warnings could result in injury or death. Contact any Rice Lake Weighing Systems dealer for replacement manuals.



Failure to heed could result in serious injury or death.

Ensure every individual who operates or works with this unit has read and understands all safety information.

Do not transport the scale while someone is on the scale.

Do not allow minors (children) or inexperienced persons to operate this scale.

Do not use in the presence of flammable materials.

Do not use this product if any of the components are loose or cracked.

Do not use near water.

Do not use the scale on slippery surfaces, such as a wet floor.

Do not use this scale when a person's body or feet are wet, such as after taking a bath.

Do not place fingers into slots or possible pinch points.

To avoid cross contamination, the scale should be cleaned regularly.

Prior to cleaning, make sure the scale is disconnected from the power source.

People with disabilities, or who are physically frail, should always be assisted by another person when using this scale.

IMPORTANT

Do not drop the scale or subject it to violent shocks.

Do not jump on the scale.

For accurate weighing, the scale must be placed on a flat, stable surface.

Operating at voltages and frequencies other than specified could damage the equipment.

Avoid contact with excessive moisture.

Do not make alterations or modifications to the scale.

Rice Lake Weighing Systems offers optional AC adapters; utilizing an adapter not supplied by Rice Lake Weighing Systems voids all warranties and approvals.

Weight exceeding the maximum capacity may damage the scale.

2.0 Assembly

2.1 Unpacking

Place the unopened shipping container in an open area with room for unpacking the scale. If parts were damaged in shipment, notify Rice Lake Weighing Systems and the shipper immediately. Parts included:

- Scale base and indicator
- Six AA batteries
- AC adapter
- USB 2.0 Cable AM/BM 1.5 M
- Serial cable 9.5 feet with female DB9 and RJ45 connectors

2.1.1 Repacking

Retain the packaging for use in the event that the scale must be returned or moved. It must be properly packed with sufficient packing materials. Whenever possible, use the original shipping carton when shipping the scale back.

IMPORTANT *Damage caused by improper packaging is not covered by the warranty.*

2.2 Scale Setup

Place the scale on a hard level surface for the most accurate weighments.



Note *Thin carpeting is acceptable but is not recommended. Weighing on carpet can cause a weight discrepancy.*

2.2.1 Leveling the Scale

On a flat surface, adjust scale feet until the bubble level indicates that the scale is level.



Figure 2-1. Bubble Level

2.3 Indicator Setup

Use the following sections to set up the provided Rice Lake Indicator.

2.3.1 Load Cell Connection

The indicator and scale comes factory installed with a load cell cable connection. Follow the procedure below if the load cell cable needs to be replaced or reconnected to the indicator.

1. Unscrew and remove the tilt stand bracket from the indicator to gain access to the load cell connection.

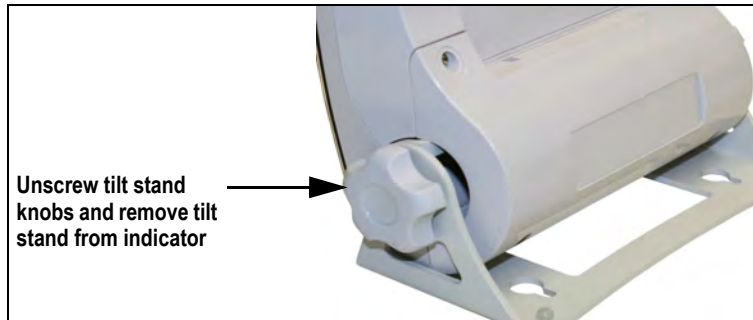

Figure 2-2. Remove Tilt Stand

2. Remove the four back retaining screws to remove the back cover to the indicator.

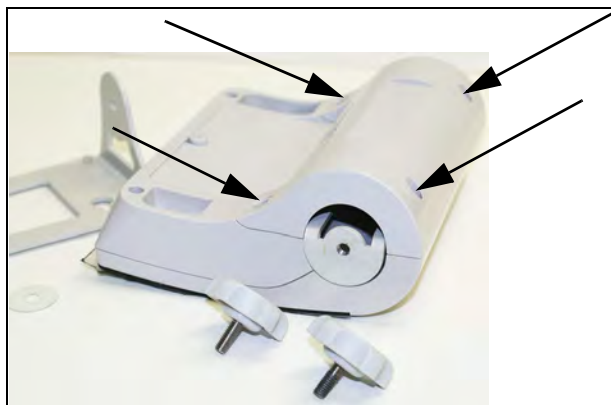

Figure 2-3. Remove Back Cover

3. Plug the end of the load cell cable into the load cell connection. When it clicks the load cell cable is properly seated into the connection.



Figure 2-4. Load Cell Connection Point

4. Reinstall the back cover and attach to the tilt stand.

2.3.2 Insert Batteries

The six AA batteries supplied with the scale provide an average of 25 hours of continuous use.

To install the batteries:

1. Turn thumbscrew counterclockwise then remove battery cover.
2. Insert batteries into the battery chamber as illustrated.



Figure 2-5. Battery Chamber

3. Put the cover in place and turn the thumbscrew clockwise to secure.



Note Remove the batteries prior to storing if the product is not going to be used for an extended period of time.



Note If the LO BAT indicator activates, for accurate weighing, replace the batteries or connect the scale to an AC power source as soon as possible.

2.3.3 Power Connection

An optional AC power adapter can be used when a power outlet is available.

IMPORTANT

Only use power adapters supplied by or purchased from Rice Lake Weighing Systems. The use of a power adapter not from Rice Lake Weighing Systems voids the warranty.



Figure 2-6. Power Connection Site



Note The battery annunciator on the display turns off when using an AC power connection.
The brightness of the backlight is reduced to 60% when using battery power.

3.0 Operation

This section describes the front panel and includes procedures for operation of the scale.



Figure 3-1. Front Panel Keypad

3.1 Key Descriptions

The display has 10 front panel keys. Key functions are described in the table below.

IMPORTANT The front panel keys are very sensitive, so only a gentle press is required.













Key	Name	Function
 On/Off	On/Off	Powers the scale on or off
 Print LB/KG	Print LB/KG	Sends data out from the RS-232 port; Allows to toggle between kilograms and pounds providing that it is enabled in Configuration mode; Cannot toggle while in the BMI mode
 Zero	Zero	Only functions if the current weight is stable and less than 2% of the capacity of the scale. Anything over 2% requires a recalibration
 Hold Release	Hold Release	Does not function when set up as an NTEP-certified scale. Displays most current weight value on the display and holds that value when the patient is off the scale. A second press releases the weight value. Not active while in BMI mode
 BMI	BMI	Does not function when set up as an NTEP-certified scale. Pressing the BMI key enables access to the BMI (Body Mass Index) mode (defaults when scale is turned on). The patient is gets on the scale, weight stabilizes and press the BMI key. The display then asks for the patient height to calculate out the patient BMI.
 TARE	TARE	Used to remove the weight initially of anything on the scale that shouldn't be included in the total weight of the patient on the scale
 CLEAR	CLEAR	When using the BMI function, the display looks for a height entry. Pressing Clear changes this entry back to 190.0 cm (default) or 5 ft, 7.5 in. Once BMI is displayed, pressing the Clear key exits BMI
 ENTER	ENTER	Used to accept height in BMI mode; accepts the value of the parameter last entered and moves to the next stage Pressing and holding Enter during startup will display ID. This is the first setup on entering into configuration mode
 Up Arrows	Up Arrows	Adjusts the value of the flashing digit/number Adjusts height input (0.5 in/0.5 cm) while in BMI mode
 Down Arrows	Down Arrows	Adjusts the value of the flashing digit/number Adjusts height input (0.5 in/0.5 cm) while in BMI mode

Table 3-1. Key Functions



3.2 Weighing

Use the following steps to weigh.

1. Press  to turn on the scale. **0.0** prompts along with **ZERO** on the display.
2. Place the patient on the scale. The patient's weight is displayed, the **LOCK** annunciator is on and the indicator beeps to indicate the end of the weighing process.
3. Press  to change the display from lb to kg and vice-versa.
4. Press and hold  until **OFF** displays to turn off the scale.

3.3 Hold/Release Function

Use the following steps to use the Hold/Release function.

1. Press  to turn on the scale. **0.0** prompts along with **ZERO** on the display.
2. Press  once the patient's weight stabilizes. The patient's weight and the **HOLD** and **LOCK** annunciators remain on the display when the patient is off the scale.
3. Press  again to return the scale to zero.





Note Pressing  will not work while using Hold/Release function.



Note Pressing  prior to the patient getting on the scale will also hold the weight display.

3.4 Preset Tare

Use the following steps for the Preset Tare function prior to patient weighing if additional items are being used by the patient.

1. Press  to turn on the scale. **0.0** appears on the display along with the **ZERO** annunciator.
2. Place additional item(s) on the scale.
3. Press  until the display returns to **0.0** and **NET** annunciator appears on the display.
4. Remove additional item(s) from the scale. The weight displays with a negative symbol to the left of it.



Note Not removing the additional item(s) prior to patient weighing will also work.





5. Position the patient and additional item(s) on the scale. The display identifies the patient weight. The **NET** annunciator is still active. The weight of the additional item(s) remains stored in memory for the duration of this weigh in.
6. To cancel the tare weight, remove patient from the scale and press  until **NET** disappears from the display and the display turns back to **0.0** and **GROSS** appears.



Note Tare weight is also canceled when the scale is turned off.

3.5 Toggle Tare

Use the following steps to use the Toggle Tare function when the additional item to be weighed is known.

1. Press  when the scale is empty and **0.0** displays. The default values prompts while **0.0** is flashing on the display (default is programmed to be 33.0 lb/15.0 kg).
2. Use  and  to adjust the value. Press  to start the tare function. The **NET** annunciator turns on instead of the **GROSS** annunciator.

3.6 Using the Body Mass Index (BMI) Function







Note





The **BMI** key does not function when set up as an **NTEP-certified scale**.

Use the following steps in determining the BMI.

3.6.1 LB Mode

1. Ensure that the scale is at zero.
2. Have the patient step onto the scale to obtain a weight. The **LOCK** annunciator appears on the display.
3. Press . The **BMI** and **FT/IN** annunciators are lit on the display and a default height value of 5 feet - 7.5 inch is flashing.
4. Use  and  to adjust the height value.
5. Press .
6. The BMI value and **BMI** annunciator are shown on the display. Press  to return to the **Weighing** mode and the BMI function will be turned off.

3.6.2 KG Mode

1. Ensure that the scale is at zero.
2. Have the patient step on the scale to obtain a weight. The **LOCK** annunciator appears on the display.
3. Press . The **BMI** and **CM** annunciators appear on the display and a default height value of 170.0 cm (170.0) is flashing.
4. Use  and  to adjust the height value.
5. Press .
6. The BMI value and **BMI** annunciator are shown on the display. Press  to return to the **Weighing** mode and the BMI function will be turned off.

3.7 Troubleshooting

Refer to the following table to check and correct any failure before contacting service personnel.

Symptom	Possible Cause	Corrective Action
Scale does not turn on	Dead batteries	Replace batteries or connect to AC power
	Faulty electrical outlet	Use a different electrical outlet
	Bad power supply	Replace adapter
Questionable weight or the scale does not zero	External object is interfering with the scale	Remove the interfering object from the scale
	Display did not show 0.0 before weighing	Help the patient off the scale, zero the scale and begin the weighing process again
	Scale is not placed on a level floor	Ensure scale is level and begin the weighing process again
	Scale is out of calibration	Check the weight with a certified calibration weight
The display shows a STOP message	The load on the scale exceeds the capacity of the scale	Remove the excess weight and use the scale according to manufacture specifications
The display shows LO Bat message	The battery is low	Replace batteries
The display shows E and Err messages as detailed below		
E06	Identifier - ADC	AD too high
E07		AD too low
E10	Overload	Scale has been overloaded. Remove load from scale
E4L	BAT	Battery low, but still usable- one bar left on indicator display
E4U		Battery low and unstable - no bars left on indicator display
E11	CAL	Calibration Error - recalibrate scale
Err 1	Load cell cable may be plugged into wrong connection port	Ensure cable is connected to the load cell connection port Note: Load cell connection point is located underneath the curved plastic cover of the indicator. Remove four back retaining screws, remove curved back cover to access load cell connection point.
Err 2	Low saturation state (low A/D)	The load cell is not connected properly; Check the cables and mechanical connections; if the problem persists, replace the set of load cells
Err 3	High saturation state (high A/D)	See Err 2
Err 6	Unstable weight; Cannot calibrate	Check the load cell mechanical surroundings and ensure nothing is contacting the load cell and that the cables are properly welded
Err 7	Scale isn't moving	Make sure feet are installed on the scale. Turn the feet all the way in and then back them out three full turns, then level the scale
SAT	Damaged load cell cable	Replace load cell cable
	Load cell cable may be plugged into wrong connection port	Ensure cable is connected to the load cell connection port Note: Load cell connection point is located underneath the curved plastic cover of the indicator. Remove four back retaining screws, remove curved back cover to access load cell connection point.

Table 3-2. Troubleshooting Table

4.0 Configuration

Options and parameter setup are done through the scale navigation.

4.1 Setup Mode

Accessing the setup menu requires the indicator to be in setup mode. It is necessary to break the seal and remove the back cover to put the indicator into setup mode. Use a Phillips head screwdriver to remove the four screws holding the cover in place (shown below - left photo).

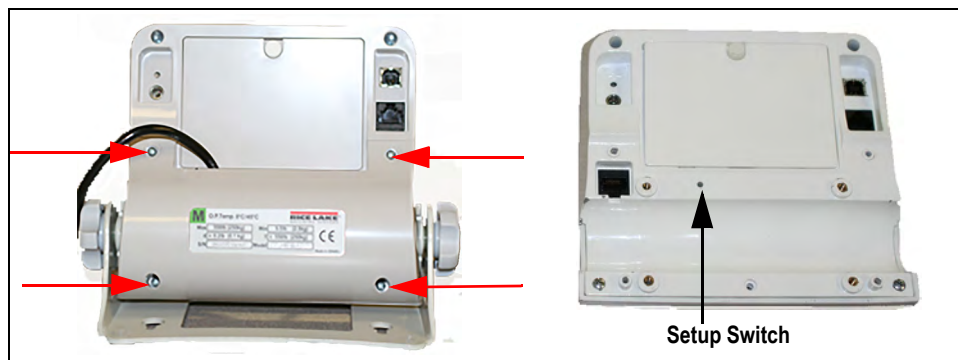



Figure 4-1. Back of Indicator

4.2 Setup Mode Navigation:





1. Ensure the scale is off.
2. Remove the back plate by loosening the two Phillips screws and two drilled hex head screws (Figure 4-1).
3. Press  to turn on the indicator. *START* displays.
4. Press and hold  until *ID* and its value flashes.

Use a small non-conductive tool to press the setup switch. *PROG* displays.





4.3 General Navigation

Use the buttons on the front panel to navigate through the menus and parameters.



4.3.1 Change Parameters

- Press  to scroll through the menus and/or parameters
- Press  to enter a displayed menu and/or parameter
- Press  or  to scroll through values
- Press  to save the displayed selection and move to the next parameter

4.3.2 Enter Numbers

- Press  to enter parameter value
- Press  or  to increment/decrement numbers
- Press  to move to the next digit
- Press  to save value and move to the next parameter

4.3.3 Save and Return to Main Menu

- When a parameters selection/value is correct, press . The next parameter displays
- When all parameters selections/values are correct, *SAVE* displays
- Press . *DONE* displays.
- Press  to save settings and return to weigh mode.

4.4 User Menu

The User Menu allows a user to set the baud, auto off time and turn several other functions on or off.

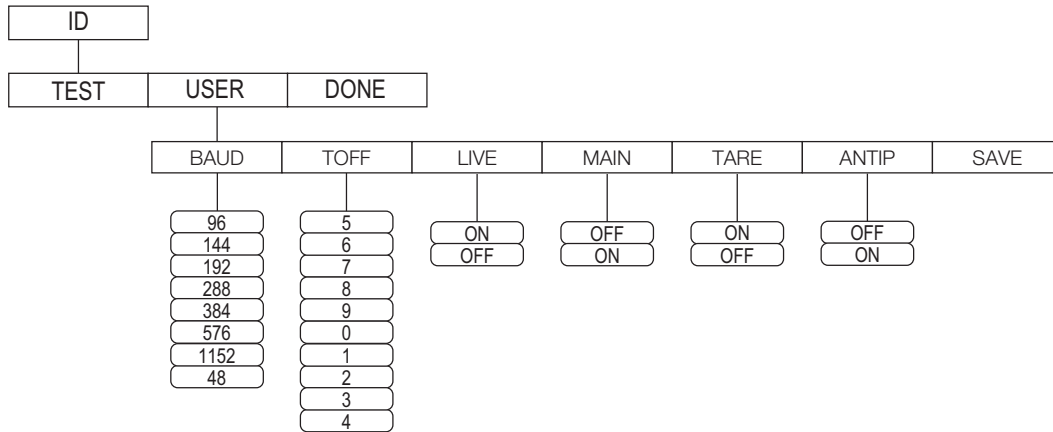

Figure 4-2. User Menu

Parameter	Description
BAUD	Baud Rate – sets the baud rate; end zeros are not displayed (96 = 9600); <i>Settings: 96 (default), 48, 1152, 576, 384, 288, 192, 144</i>
TOFF	Auto Off Timer – turns unit off after the set number of minutes; 0 = always on; battery power only, does not work if using an external power supply; <i>Settings: 5 (default), 6, 7, 8, 9, 0, 1, 2, 3, 4</i>
LIVE	Live Weighing – enables or disables live weighing; must be set to <i>ON</i> for use as an certified NTEP scale; if set to <i>OFF</i> , the weight stabilizes, the <i>LOCK</i> annunciator displays and an audible tone indicates the end of the weighing process; <i>Settings: ON (default), OFF</i>
MAIN	Communication Protocol – enables or disables the communication protocol; <i>Settings: OFF (default), ON</i>
TARE	Tare – enables or disables the tare function; a tare subtracts weight of accessory items from the scale; <i>Settings: ON (default), OFF</i>
ANTIP	Anti Pressing – when set to <i>OFF</i> the display blinks for two seconds when weight is unstable under the <i>ASTART</i> value; when set to <i>ON</i> the display does not blink; does not function when set up as an NTEP-certified scale (when <i>LIVE</i> set is to <i>OFF</i>); <i>Settings: OFF (default), ON</i>
SAVE	Saves settings and returns to upper level; only appears if changes have been made

Table 4-1. User Menu Parameters

User Menu Navigation:



1. Press to turn on the indicator. *START* displays.
2. Press and hold until *ID* and its value flashes.
3. Press . *TEST* displays.
4. Press . *USER* displays.
5. Press . *BAUD* and its value flashes.
6. Press to scroll through the menu items.
7. Press to edit a parameter setting.
8. Press or to select the setting and press to save the setting and move to next parameter.
9. *SAVE* displays at the end of the menu if a change was made. With *SAVE* displayed, press . *DONE* displays.
10. Press . The indicator resumes the self test and returns to weigh mode.



Note Press when *SAVE* displays, to return to weigh mode without saving

4.5 Configuration Mode

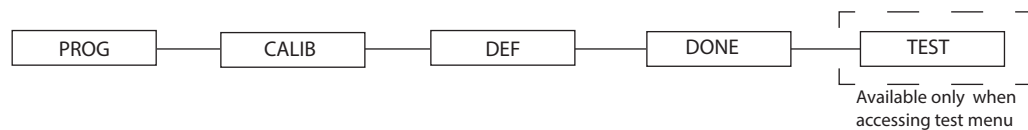

Use the following steps to enter into **Configuration** mode.

1. Ensure the scale is turned off.
2. Turn the scale on by simultaneously pressing  and . Continue to hold both keys until **ld** appears. The unit cycles through its startup function and continues to display the software version.
3. Access the setup switch located in the back of the scale to enter the setup parameters for the scale. Use a small paper clip, small screwdriver or other similar object to press the setup switch.
4. Once the setup switch is pressed, **PROG** displays.
5. Scale can be configured using a series of menus accessed through the front panel when the scale is in **Setup** mode.



See [Section 4.9 on page 16](#)

Figure 4-3. Top Level Menu

6. Press  to advance to the desired menu.
7. Press  and advance in the manual to the related menu selection for further instructions.

4.6 Default Scale

The default parameter is used to return the scale to the original factory settings. This does not change the calibration.

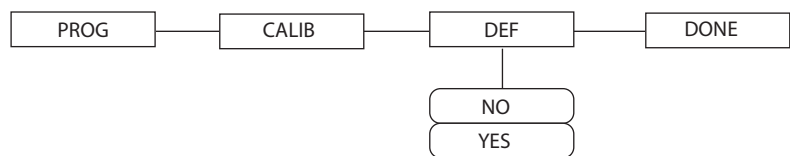









Figure 4-4. Default Parameter

Default Scale Navigation:

1. Enter setup mode ([Section 4.7 on page 14](#)). **PROG** displays.
2. Press  twice. **DEF** displays.
3. Press . **NO** displays.
4. Press . **YES** displays.
5. Press . **DONE** displays.
6. Press  to return to the setup menu. **DEF** displays.
7. Press . **DONE** displays.
8. Press . The indicator resumes the self test and returns to weigh mode.

4.7 Program Menu

The program menu allows for the setup of the indicator to determine how the scale reads the weight and displays output.

To enter the program menu:

1. Enter setup mode (Section 4.7).
2. With *PROG* displayed, press .
3. Use the navigation instructions in Section 4.9 on page 16, to set the necessary *PROG* parameters.

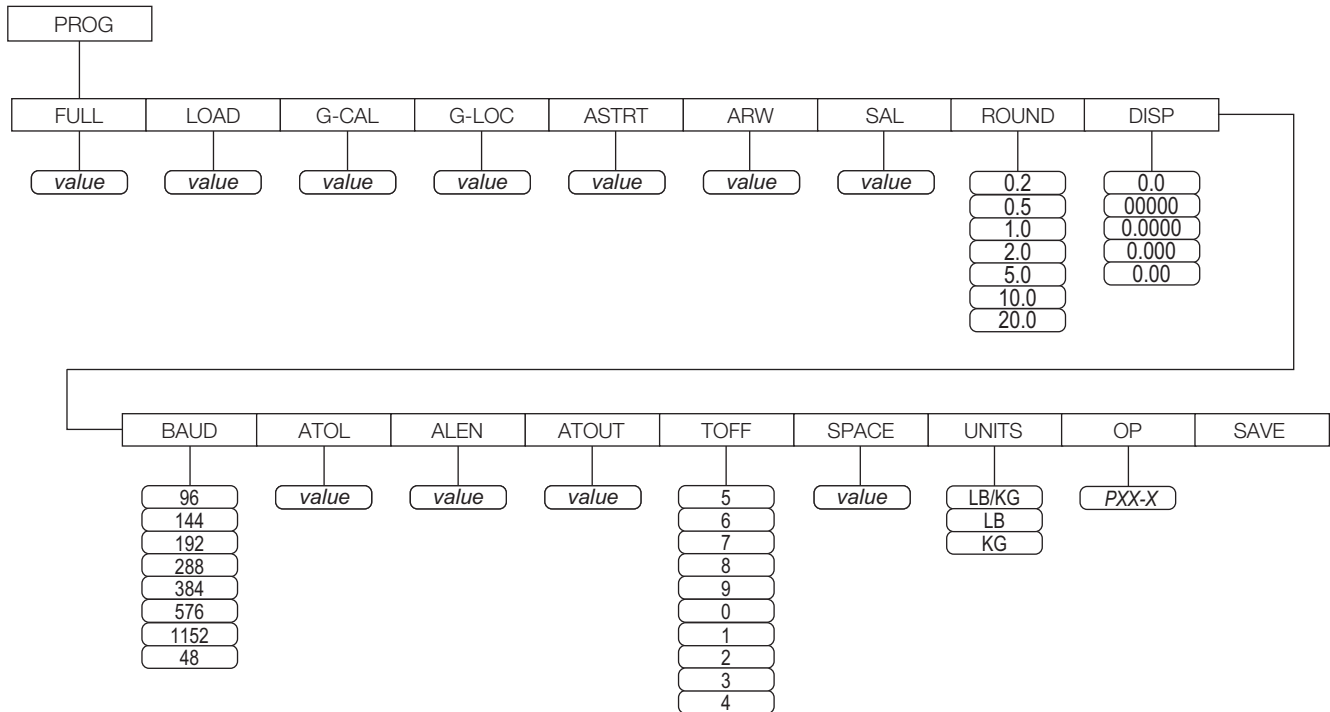

Figure 4-5. Program Menu

Parameter	Description
FULL	Full Capacity – enter value of the scale capacity; default: 550.0 lb
LOAD	Load – weight applied during calibration (can also be set during calibration process); default: 200.0 lb
G-CAL	Gravity Calibration – sets gravity for original calibration; default: 00000
G-LOC	Gravity Location – sets gravity for location of use; default: 00000
ASTRT	Auto-Start – weight process start limit; maximum (full capacity)/10; determines when the weight algorithm starts; default: 4.0 lb
ARW	Auto Reweigh – restarts the weight algorithm if the weight changed by more than this value; default: 4.0 lb
SAL	Semi Auto Live – interval between weight displays during the algorithm process; default: 0.5
ROUND	Scale Resolution – sets the scale resolution value; <i>Settings: 0.2 lb (default), 0.5, 1.0, 2.0, 5.0, 10.0, 20.0, 0.2</i>
DISP	Decimal Point – sets the decimal point location; <i>Settings: 0.0 (default), 00000, 0.0000, 0.000, 0.00</i>
BAUD	Baud Rate – sets the baud rate; end zeros are not displayed (96 = 9600); <i>Settings: 96 (default), 144, 192, 288, 384, 576, 1152, 48</i>
ATOL	Algorithm Initial Tolerance – a value above 255 (max) does not allow indicator to proceed and returns to the previous value; default: 10
ALEN	Algorithm Initial Exponent – a value above 10 (max) does not allow indicator to proceed and returns to the previous value; default: 8
ATOOUT	Algorithm Maximal Exponent – a value above 15 (max) does not allow indicator to proceed and returns to the previous value; default: 10
TOFF	Auto Off Timer – turns unit off after the set number of minutes; 0-9 minutes; 0 = always on; default: 5 min NOTE: Battery power only, does not work if using an external power supply.
SPACE	Space – number of new lines after print; default: 7



Table 4-2. Program Menu Parameters

Parameter	Description
UNITS	Units – select the unit of measure; <i>Settings: LB/KG (default), LB, KG</i> NOTE: When indicator is set to LB or KG, toggling between them is not available in the weighing mode.
OP	Binary options: <ul style="list-style-type: none"> • P00 — Live weighing options (0=disable, 1=enable); default: 1 • P01 — Communication protocol (0=ESC, 1=maintenance); default: 0 • P02 — BMI menu (0=disable, 1=enable); default: 1 • P03 — RTC power (0=disable, 1=enable); default: 0 • P04 — Semi Auto Live (0=disable, 1=enable); default: 1 • P05 — Full calculation (0=spatial, 1=multiply by (0=disable, 1=enable); default: 0 • P06 — Tare (0=disable, 1=enable); default: 1 • P07 — Bat type (0=dry batteries, 1=rechargeable batteries); default: 0 • P08 — OIML mode (0=disable, 1=enable); default: 1 • P09 — USB (0=disable, 1=enable); default: 0 • P10 — Anti pressing (0=disable, 1=enable); default: 0 • P11 — Last (0=off, 1=on); default: 1
SAVE	Saves settings and returns to upper level

Table 4-2. Program Menu Parameters (Continued)





4.8 Scale Calibration

Use the following steps to calibrate the scale.

1. Enter the setup mode (Section 4.7 on page 14). *PROG* displays.
2. Press . *CALIB* displays.
3. Press . A numeric value displays (weight to be used for calibration).



Note Calibrate in the unit of measure that the scale is intended to be used. Press  or  to change units.

4. Press . The digit on the right flashes.
 - Press  or  to change the value of digit.
 - Press  to move to the next digit.
 - When the desired value is displayed, press . *CLEAR* displays.





Note To quit calibration, press  or . *ABORT* displays. Press  to abort and return to upper level.

5. Remove all weight from scale platform, then press . ===== displays.
6. When *PUT and set weight* value flashes on display, put the displayed weight value on the scale platform.
7. Press . ===== and then *Save* displays.



Note Press  to exit calibration without changing the existing zero or span calibration.

8. Press . *DONE* displays.
9. Press  three times to navigate to the top level *DONE* parameter.
10. Press . The indicator resumes the self test and returns to weigh mode.

4.9 Test Menu

This menu is read only.

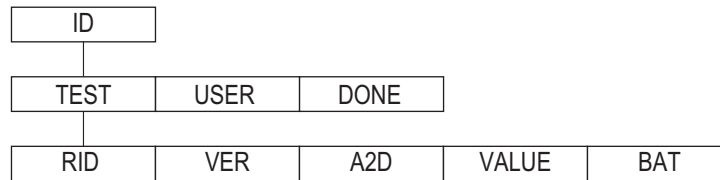









Figure 4-6. Test Menu

Parameter	Description
RID	Internal ID number
VER	Development internal sub version
A2D	Raw weight data
VALUE	Processed weight in live display
BAT	Relative raw battery value

Table 4-3. Test Menu Parameters

Test Menu Navigation:

1. Press  to turn on the indicator. *START* displays.
2. Press and hold  until *ID* and its value flashes.
3. Press . *TEST* displays.
4. Press . *RID* and its value flashes.
5. Press  to scroll through the menu items.
6. When *TEST* displays again, press  two times to navigate to the top level *DONE* parameter.
7. Press . The indicator resumes the self test and returns to weigh mode.

5.0 Communication

The unit comes with an RS-232 port that enables weight data to be transmitted to other equipment, such as a computer or printer. The RS-232 cable with DB-9 connector (PN 100719) is available from Rice Lake Weighing Systems. That connection is shown in USB Connection section.

The RS-232 parameters are:

- 9600 baud (selectable in the programming mode)
- 8 data bits
- 1 stop bit
- no parity
- no handshaking

There are three methods of communication:

- Push-button keypad print
- Standard remote protocol
- Escape protocol

5.1 Push-button Keypad Print

With a stable, in-range weight, press and hold  for at least three seconds, or until the scale emits two quick beeps.



Note If the scale does not beep after five seconds, release  as the weight was either in motion or out of range.

If displaying weight and not BMI, the scale will send out the following 21 character string:

```
xxxxxxxx<SP>uu<SP>mmmmm<SP><CR><LF>
```

Token	Description
xxxxxxxx	Weight with decimal point and “.” sign
<SP>	Space
uu	Unit - lb or kg
mmmmm	Mode - gross or net
<CR>	Carriage return
<LF>	Line feed (moves cursor down to the next line)

Table 5-1. Print Format Tokens

Example:

```
60.1 KG= <PATIENT><SP><WEIGHT><SP>-60.1<SP>KG<SP><CR><LF>
```

In BMI mode (displaying the BMI value), the scale will send out the following data:

```
PATIENT WEIGHT    60.1 KG
PATIENT HEIGHT 170.0 CM
PATIENT BMI       20.8
```

Example in KG:

```
<PATIENT><SP><WEIGHT><SP>-60.1<SP>KG<SP><CR><LF>
<PATIENT><SP><HEIGHT><SP>-170.0<SP>CM<SP><CR><LF>
<PATIENT><SP><B><SP><M><SP><I><SP><SP><SP><20.8<SP><SP><SP><SP><CR><LF>
```

Example in LB:

```
<PATIENT><SP><WEIGHT><SP>132.4<SP>LB<SP><CR><LF>
<PATIENT><SP><HEIGHT><SP>-5-07.5<SP>FT<SP><CR><LF>
<PATIENT><SP><B><SP><M><SP><I><SP><SP><SP><20.4<SP><SP><SP><SP><CR><LF>
```

In case of under weight or over weight, the word **Under** or **Over** will be sent correspondingly.

5.2 Communication Protocols

The scale has two communication protocols, escape and maintenance protocol.

5.2.1 Escape Protocol

An escape protocol is where the escape (0X1B or ASCII 27) is used to indicate that there is a command following. On the PC side there must be a listener created by the vendor that will interpret this protocol. This listener must also take care of all the issues regarding data integrity to make sure that the data that was sent and received is valid.

Two examples include:

- Scale initiated communication
- PC initiated communication

The escape protocol commands table shows (below) what can be sent across communications lines.

PC Initiated	ESC Value
Request current values/settings	R
Diagnostics	A
Send scale control messages	C
PC Initiated	ESC Value
Send single reading	R
Send diagnostic response	

Table 5-2. Escape Protocol Commands

ESC characters that will be used is shown below.

Name	ESC Character	ESC Value with Parameters	Description
Reading	R	R	Tells PC the scale is sending a reading; immediately following this is the value that is sent Example: <ESC><R>ESC><W0200.0<ESC>Nm<ESC>E
Weight	W	Wnnn.n	The patient weight (<i>Example: W02000 means 200.0</i>). If scale is overloaded or under loaded, 999.99 is returned
Height	H	Hnnn.n	Patient height
BMI	B	Bnn.n	Patient BMI
Units	N	Nc	Indicates the units the values have been taken (<i>m=metric, c=constitutional</i>).
End of Packet (EOP)	E	E	Indicates the end of the command has been reached.
Diagnostics (request)	A	Accc	A request for a diagnostic test on certain parts of the scale (like battery life, load cells).
Diagnostics (response)	Z	Zccc	The response of the diagnostics done on the scale; values include error codes to indicate an issue, or all zeros (Z000) to indicate the scale is performing properly
Control (set a value)	C	Cccc=c	Sets the value of the scale's global settings <i>Example: <ESC><CUOM=m><ESC><E sets the unit of measurement</i>

Table 5-3. ESC Characters

Name of Control	Identifier	Unit
Unit of Measure (metric or constitutional)	UOM	c (m or c)

Table 5-4. Scale Global Values and Identifiers

Samples of Escape Protocol

Examples of what is sent to the computer from the scale.

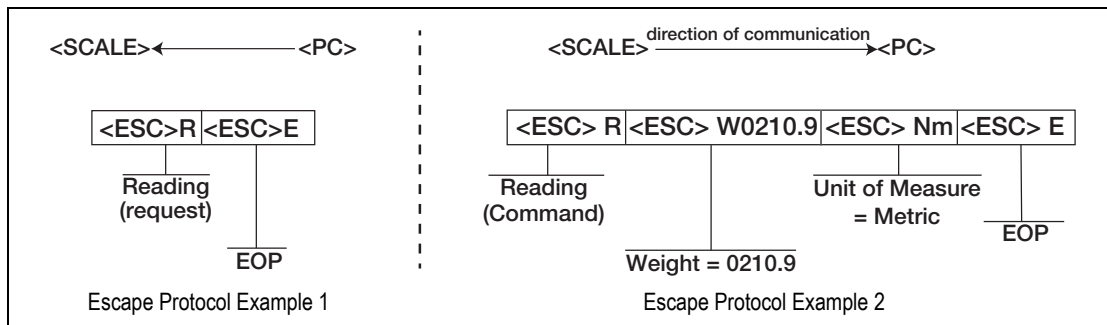

Figure 5-1. Escape Protocol Examples

Examples of diagnosing battery request and responses.

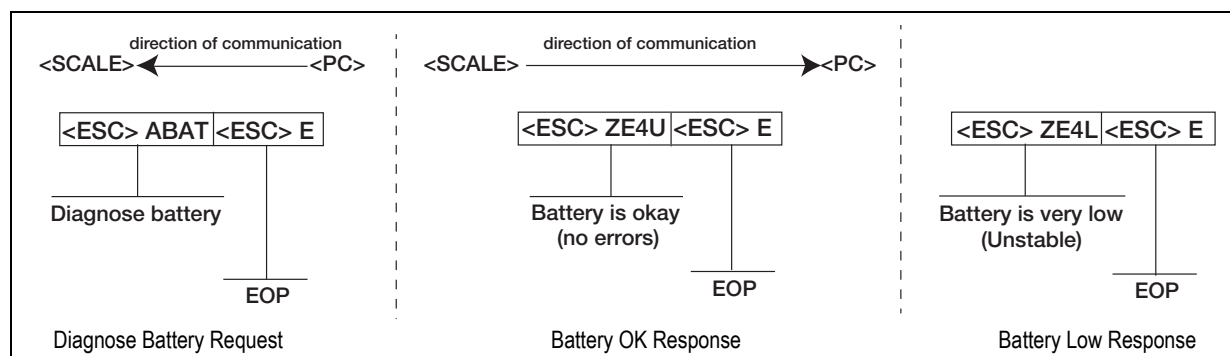

Figure 5-2. Diagnose Battery Examples

5.2.2 Maintenance Protocol

Maintenance protocol commands are listed below.

Command	Definition
R	Reboot
V	Firmware ID + development version
W	Current weight
A	Current AD
Z	Zero the scale
F	Show flash values (used for the first flash process)
L	USB On/Off (not available on USB communication)

Table 5-5. Maintenance Protocol Commands

5.3 USB Connection

The scale has the capability of connecting to a Windows® computer (PC) using a USB cable (not included) and a terminal emulation program. A terminal emulation program allows the transfer of data between the scale and PC using a serial port.



Figure 5-3. Connection Ports

Note Apple® and Macintosh® computers are unable to transfer the necessary data to the scale. Only use a PC for data transfer.

Connecting software and downloads should always be addressed by the IT department for safety reasons and can vary depending on what type of computer platform is being used.

Note Consult the IT department if driver protections are preventing the use of the USB driver. Driver protections may need to be temporarily disabled on Windows 10 or later computers to allow for the installation of the USB driver.

1. Connect the scale's indicator to a PC using a USB-Type B to USB-Type A cable (not included).
2. Turn the indicator on.

Note In most cases, the PC should find the driver and automatically configure the driver when the scale is plugged into a USB port.

3. Open a terminal emulation program, such as Advanced Serial Port Terminal, pUttY or Hercules (used in this example).
4. Connect to the serial port assigned by the PC (COM5 in example). This can be found in Device Manager. Once selected, press **Open**.

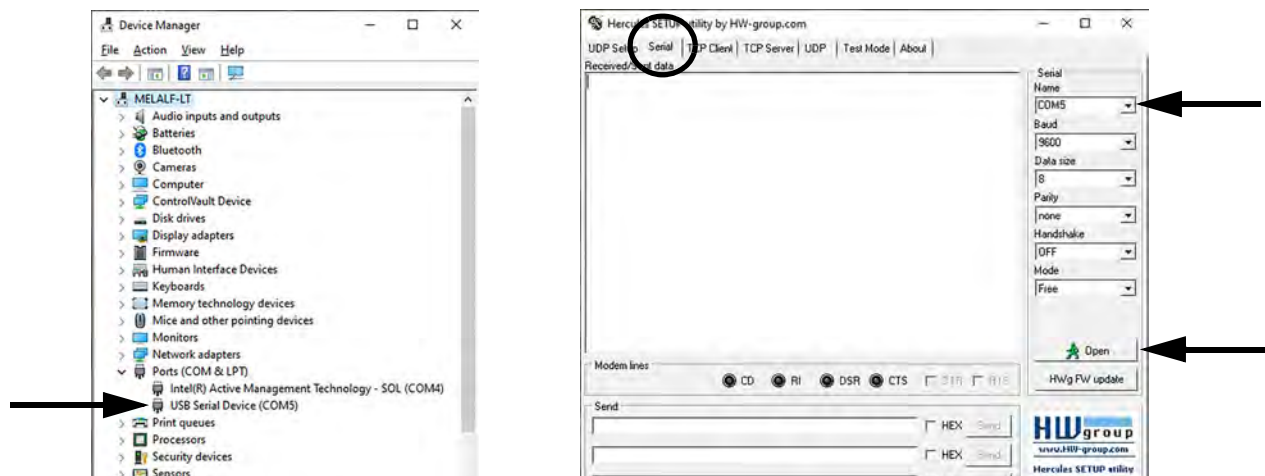

Figure 5-4. Connecting to a Serial Port

5. With weight on the scale, press and hold the **Print** button on the indicator for three seconds. The patient's weight is sent to the PC.

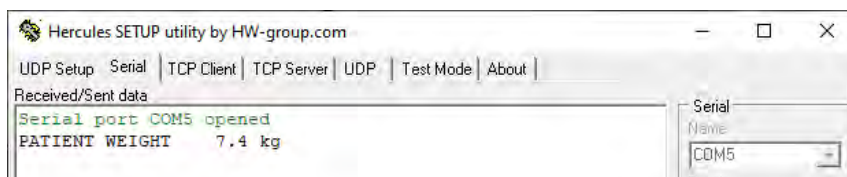

Figure 5-5. Patient Weight Displayed

6.0 Sealing of the Unit

The 160-10-7N Low-Profile Digital Athletic Scale is an NTEP certified scale. To maintain NTEP certification, the unit must not be opened.

6.1 NTEP Regulations

Weights and Measures stickers or foil labels are used on both sides of the unit to seal and prevent it from being opened.

Whoever installs the scale is responsible for placing stickers on the unit. The desired sticker location is noted in [Figure 6-1](#).

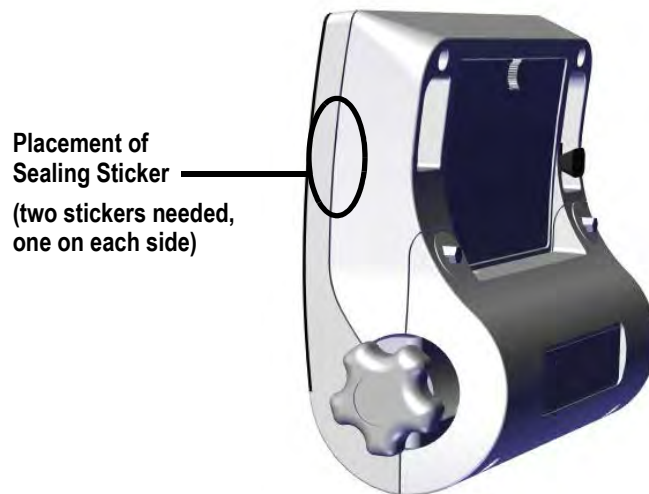

Figure 6-1. Desired Sealing Sticker Location

6.2 Measurement Canada Regulations

Lead wire sealing can be used to comply with Measurement Canada and NTEP regulations.



Figure 6-2. Wire Sealing Location

7.0 Maintenance

The following section provides instructions for maintaining and cleaning the unit.

IMPORTANT

Do not immerse the scale in cleaning or other liquid solutions.

Do not use Isopropyl alcohol or other solutions to clean the indicator display surface.

7.1 Basic Maintenance

Before the first use of the scale and after periods of non-use, check the scale for proper operation and function. If the scale does not operate correctly, contact a qualified service personnel.

Go through the following steps for basic maintenance.

- Check the overall appearance of the entire scale for any obvious signs of damage
- Inspect the condition of the AC power adapter cord for cracking, fraying or for broken or bent prongs

7.2 Cleaning

Proper care and cleaning is essential to ensure a long life of accurate and effective operation. Before beginning the cleaning process, disconnect the scale from the AC power source.

- Clean all external surfaces with a clean, damp cloth or tissue. Mild soap and water solution may be used. Dry with a clean soft cloth
- Do not immerse the scale into cleaning or other liquid solutions
- Do not use Isopropyl alcohol or other solutions to clean the display surface

8.0 Specifications

Power

9 VDC, provided by six AA alkaline batteries (included)
120/230 VAC adapter, NEMA 1-15 plug (included)

Battery Type

Six AA alkaline (included)

Battery Use

25 hours continuous use with batteries
Automatic power-off can be configured

Data Communications

Connections	RS-232 with RJ45 jack, USB
Baud Rate	9600 (Default)
Bits	8; 1 stop bit
Parity	None
Handshaking	None

Environmental

Operating Temperature 41°F to 95°F (5° to 35°C)

Capacity

550 lb x 0.2 lb (250 kg x 0.1 kg)

Dimensions

W x L x H: 14.4 in x 14.4 in x 1.65 in (36.6 cm x 36.6 cm x 4.2 cm)

Display

5-digit LCD display, 0.75 in (1.9 cm) digit height

Warranty

Two-year limited warranty

Certifications and Approvals



CC 18-011



AM-6097



E113986



© Rice Lake Weighing Systems Specifications subject to change without notice.

230 W. Coleman St. • Rice Lake, WI 54868 • USA

U.S. 800-472-6703 • Canada/Mexico 800-321-6703 • International 715-234-9171 • Europe +31 (0)26 472 1319