

# FlexWeigh System 103

*Loss-in Weigh Dispensing Controls  
Version 1*

## Operation Manual



© Rice Lake Weighing Systems. All rights reserved.

Rice Lake Weighing Systems® is a registered trademark of  
Rice Lake Weighing Systems.

All other brand or product names within this publication are trademarks or  
registered trademarks of their respective companies.

All information contained within this publication is, to the best of our knowledge, complete and  
accurate at the time of publication. Rice Lake Weighing Systems reserves the right to make  
changes to the technology, features, specifications and design of the equipment without notice.

The most current version of this publication, software, firmware and all other product  
updates can be found on our website:

[www.ricelake.com](http://www.ricelake.com)

# Contents

<b>1.0 Introduction</b>	<b>1</b>
1.1 Standard Features	2
1.2 Operation Menu Softkeys	3
<b>2.0 Installation</b>	<b>4</b>
2.1 Unpacking and Assembly	4
2.2 Enclosure Disassembly	4
2.3 Cable Connections	4
2.4 Cable Grounding	5
2.5 Parts Kit Contents	5
2.6 Option Cards	6
<b>3.0 Setup Menu</b>	<b>7</b>
3.1 Entering the Setup Menu	7
3.2 Setting the System Time and Date	8
3.3 Modifying the Setup Password	9
3.4 Enabling/Disabling Additional Data Fields	9
3.5 Modifying the Dispensing Speeds	10
3.6 Modifying Auto Print	10
3.7 Delay After Discharge	11
3.7.1 Test Digital IO	12
<b>4.0 Operation</b>	<b>13</b>
4.1 Entering Presets Softkey Menu	13
4.1.1 Target Weight	14
4.1.2 Dribble Weight	14
4.1.3 Preact Weight	15
4.1.4 High Level Weight	15
4.1.5 Low Level Weight	15
4.1.6 Slow Cycle Time	16
4.1.7 Exit	16
4.2 Entering Totals Softkey Menu	16
4.2.1 Consecutive Number	17
4.2.2 Print Sub Total	17
4.2.3 Print Total	18
4.3 Dispensing Material from a Scale	18
4.4 Pausing/Resume/Reset a Dispense	19
4.5 Audit Trail Print	20
<b>5.0 Appendix</b>	<b>21</b>
5.1 Options	21
5.2 FCC Compliance	21
5.2.1 Radio Certificate Numbers	22
5.3 Product Dimensions	22
5.4 Replacement Parts	23
<b>6.0 Limited Warranty</b>	<b>25</b>
<b>7.0 Compliance</b>	<b>26</b>



Technical training seminars are available through Rice Lake Weighing Systems. Course descriptions and dates can be viewed at [www.ricelake.com/training](http://www.ricelake.com/training) or obtained by calling 715-234-9171 and asking for the training department.



*Rice Lake continually offers web-based video training on a growing selection of product-related topics at no cost. Visit [www.ricelake.com/webinars](http://www.ricelake.com/webinars)*

# 1.0 Introduction

This manual is intended for use by service technicians and operators responsible for installing and operating the FlexWeigh System 103 Loss-in-Weight controller.

Additional information on the actual hardware features of the 920i are explained in the 920i Installation and Operation Manual (PN 67887) and is included with this product.

## Safety Signal Definitions:



**DANGER** Indicates an imminently hazardous situation that, if not avoided, will result in death or serious injury. Includes hazards that are exposed when guards are removed.



**WARNING** Indicates a potentially hazardous situation that, if not avoided, could result in serious injury or death. Includes hazards that are exposed when guards are removed.



**CAUTION** Indicates a potentially hazardous situation that, if not avoided, could result in minor or moderate injury.



**IMPORTANT** Indicates information about procedures that, if not observed, could result in damage to equipment or corruption to and loss of data.

## General Safety



**Do not operate or work on this equipment unless this manual has been read and all instructions are understood. Failure to follow the instructions or heed the warnings could result in injury or death. Contact any Rice Lake Weighing Systems dealer for replacement manuals.**



**Failure to heed could result in serious injury or death.**

**Failure to heed may result in serious injury or death.**

**Some procedures described in this manual require work inside the indicator enclosure. These procedures are to be performed by qualified service personnel only.**

**Do not allow minors (children) or inexperienced persons to operate this unit.**

**Do not operate without all shields and guards in place.**

**Do not step on the unit.**

**Do not jump up and down on the scale.**

**Do not use for purposes other than weight taking.**

**Do not place fingers into slots or possible pinch points.**

**Do not use any load bearing component that is worn beyond 5% of the original dimension.**

**Do not use this product if any of the components are cracked.**

**Do not exceed the rated load limit of the unit.**

**Do not make alterations or modifications to the unit.**

**Do not remove or obscure warning labels.**

**Do not use near water.**

**Before opening the unit, ensure the power cord is disconnected from the outlet.**

**Keep hands, feet and loose clothing away from moving parts.**

## 1.1 Standard Features

The FlexWeigh System 103 comes with the following standard features:

- Wallmount stainless steel enclosure
- Front panel switches including E-Stop, Reset/Resume, Start
- Softkeys for presets, CN#, Alpha-numeric ID#1, Alpha-numeric ID#2, and Totals
- Accumulating subtotal and total registers
- Transmitted audit trail
- Digital I/O board
- Relay rack and SSR relay outputs
  - Fast feed
  - Slow feed
  - Fill complete (optional)
  - Zero tolerance (optional)



### Note

*The iRite program and source code that make up the 920i FlexWeigh 103 are property of the manufacturer. Modifications to this program and equipment must be performed by Rice Lake Weighing Systems. For more information on the iRite compiler utility program, refer to the 920i Installation and Operation Manual (PN 67887) and is included with this product.*

## 1.2 Operation Menu Softkeys

Operation menu softkeys are defined to provide flexibility of operator functions for specific applications. Softkey assignments are listed on the tabs shown at the bottom of the LCD display and softkey functions are activated by pressing the arrow keys below the softkey tabs. They are password protected and offer access to the following:

- Presets
- ID #1
- ID #2
- Totals
- Setup Menu

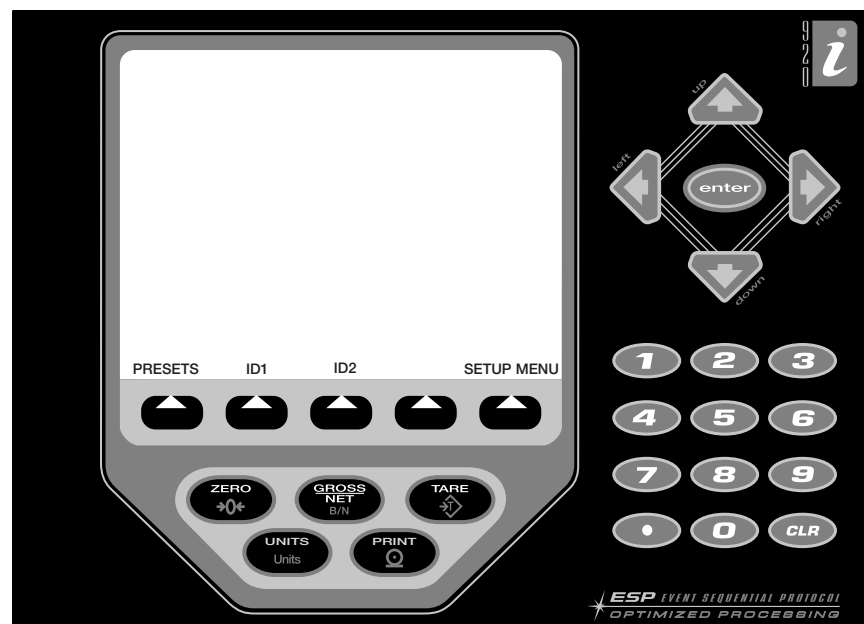

Figure 1-1. 920i Front Panel

The softkeys shown on the display are determined by the indicator configuration and program.

Softkey	Default	Softkey	Description
Time/Date	Current	Time/Date	Time and date of 920i
System Password	*****	Setup Password	Changing the password that is required for entry into the setup menu. Setting the password to nothing will cause the system to not prompt for a password when the Setup Menu softkey is pressed.
Enabling/Disabling ID#1	-	ID #1	This allows the operator to log an extra data field. A softkey will appear on the main screen to allow the operator to enter more data (ie: formula, ID Truck, container, operator)
Enabling/Disabling ID#2	-	ID #2	This allows the operator to log an extra data field. A softkey will appear on the main screen to allow the operator to enter more data (ie: formula, ID Truck, container, operator)
Dispensing Speeds	Single Speed	Single, Dual or Parallel	Allows the operator to change the dispense speed operations
Auto Tare Feature	Enabled	Auto Tare Enabled/Disabled	Allows the operator to enable/disable the auto tare feature
Auto Print Feature	Enabled	Auto Print Enabled/Disabled	Allows the operator to enable/disable the auto print feature
Delay After Discharge	-	Delay After Discharge	Allows the operator to enter a time in seconds to delay after completion of Discharge before a new Start input is enabled.

Table 1-1. Configurable Softkeys

## 2.0 Installation

This section describes procedures for setting up the FlexWeigh System 103 to weigh.



**Use a wrist strap to ground yourself and protect components from electrostatic discharge (ESD) when working inside the indicator enclosure.**

**The supply cord serves as the power disconnect for the unit. The power outlet supplying the indicator must be installed near the unit and be easily accessible.**



**The FlexWeigh System 103 has no on/off switch. Before opening the unit, ensure the power cord is disconnected from the power outlet.**

### 2.1 Unpacking and Assembly

Immediately after unpacking, visually inspect the unit to ensure all components are included and undamaged. The shipping carton should contain the FlexWeigh System 103 unit and this manual. If any parts were damaged in shipment, notify Rice Lake Weighing Systems and the shipper immediately.

### 2.2 Enclosure Disassembly

The FlexWeigh System 103 must be opened to install option cards and to connect cables for installed option cards. Ensure power to the indicator is disconnected, then open the enclosure.

### 2.3 Cable Connections

The FlexWeigh System 103 provides eleven cord grips for cabling into the indicator. The parts kit includes cord grip plugs to prevent moisture from entering the enclosure. Install these plugs into all cord grips that will not be used in your application. Use the cable grounding instructions for wiring into the indicator.

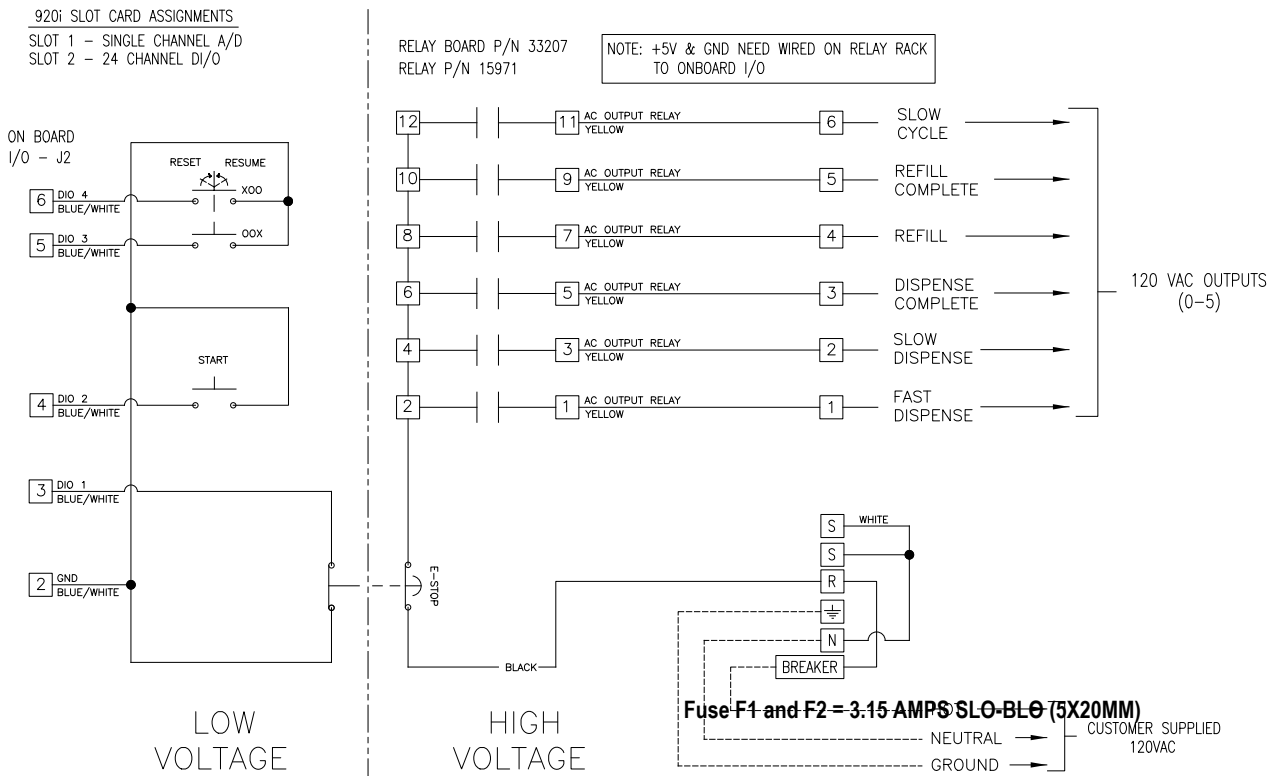

Figure 2-1. Block Wiring Diagram



**An additional adhesive label (PN 121108) is included in the parts kit and can be installed at the installer's discretion indicating correct terminal block numbering.**



**Circuit breaker = 4 A. All wires are 18 AWG unless otherwise specified. Dashed lines represent field wiring.**



## 2.4 Cable Grounding

Cables routed through the cord grips should be grounded against the indicator enclosure. Follow cable grounding instructions in the 920i Installation and Operation Manual (PN 67887) which is also included with this product.

## 2.5 Parts Kit Contents

Table 2-1 lists the parts kit contents for the FlexWeigh System 103.

Part No.	Description	Qty.
14626	Kep nuts, 8-32NC (6)	6
15133	Lock washers, No. 8, type A (6)	6
15631	Cable ties (4 single A/D, 6 dual A/D)	4
15665	Reducing glands for 1/2 NPT cord grips (11)	11
15887	6-position screw terminal for load cell connection (1-single A/D, 2-dual A/D)	1
19538	Cord grip plugs (10-single A/D, 9-dual A/D)	10
94422	Capacity Label (1-single A/D, 2-dual A/D)	1
53075	Cable shield ground clamps (6)	6
70599	6-position screw terminals for J2 and J10 (2)	2
71125	3-position screw terminal for J11 (1)	1
71126	4-position screw terminal for J9 and optional keyboard connection (2)	2
121108	Label, Terminal Block Identification (1)	1

Table 2-1. Parts Kits Contents (PN 121143)



**Note** See [Figure 5-2 on page 23](#) for a complete list of replacement parts.

## 2.6 Option Cards

Table 2-2 list the available option card that are used in the FlexWeigh System 103. The single channel A/D card can be installed in slot 1 and the 24 channel I/O card in slot 2.

Slot	Type
1	Single Channel A/D Card
2	24 Channel I/O Card

Table 2-2. Option Card Locations

### Digital I/O

Slot	Bit	Type	Function
0	1	Programmability	E-Stop
0	2		Start
0	3		Resume
0	4		Reset
0	5-6	Off	Currently not used
2	1	Output Off	Fast Dispense
2	2		Slow Dispense
2	3		Dispense Complete
2	4		Refill
2	5		Refill Complete
2	6		Slow Cycle
2	7-24	Off	Currently not used

Table 2-3. Digital I/O Assignments

### Serial Ports

Port	Type	Description	Setup
1	CMD	Currently not used	9600 baud 8 bit None 2
2	CMD/KEYBOARD	iRev downloads/operator input	115200 8 bit None 2
3	CMD	Audit trail printer	9600 baud 8 bit None 2
4	CMD	Currently not used	9600 baud 8 bit None 2

Table 2-4. Serial Port Setup

## 3.0 Setup Menu

This section describes the various setup parameters for the FlexWeigh System 103.

### 3.1 Entering the Setup Menu



**Note** The front panel E-stop button must be in the stopped position (pushed in) to enable the following keypad entries.

- Press the **Setup Menu** softkey on the main menu screen and the system performs one of the following actions.
  - If a system password is entered, proceed to Step 2.
  - If no system password is entered, the *Setup Menu Main Screen* will display (see [Figure 3-1](#)).
- Press the **Setup Password** softkey. The system prompts with *Enter Password*.

05/20/2011	02:15PM	SCALE #1
Gross Lb		SCALE #1
Setup Menu		
Program: Express 103 PN120598 (V 1.00)		
ID #1 (disabled)	Start	<input type="radio"/> Refill Cmpt
ID #2 (disabled)	Resume	<input type="radio"/> Disp Cmpt
Single-Speed (enabled)	Reset	<input type="radio"/> Slow Cycle
Auto Print (disabled)	Stop	<input type="radio"/> Disp Slow
Delay After Discharge (sec) 3.0	Refill	<input checked="" type="checkbox"/> Disp Fast
Enter New Password		
=>		
Home	Cancel	End

Figure 3-1. Setup Menu Enter Password

- Enter the password and press the **Enter** key on the 920i. The system checks the entered value against the system password and performs one of the following actions:
  - If the password is valid the *Setup Menu Main Screen* will display (see [Figure 3-2](#)).
  - If the password is invalid, *Invalid password* will display momentarily and display exits the operation.

When the system password criteria is satisfied the following display is shown.

05/20/2011	02:15PM	SCALE #1
Gross Lb		SCALE #1
Setup Menu		
Program: Express 103 PN120598 (V 1.00)		
ID #1 (disabled)	Start	<input type="radio"/> Refill Cmpt
ID #2 (disabled)	Resume	<input type="radio"/> Disp Cmpt
Single-Speed (enabled)	Reset	<input type="radio"/> Slow Cycle
Auto Print (disabled)	Stop	<input type="radio"/> Disp Slow
Delay After Discharge (sec) 3.0	Refill	<input checked="" type="checkbox"/> Disp Fast
Setup Menu		
Time/Date	Setup Password	More =>
ID #1	ID #2	

Figure 3-2. Setup Menu Main Screen

## 3.2 Setting the System Time and Date

Use the following steps to set up the system time and date.

1. From the *Main Setup Menu Screen*, press the **Time/Date** softkey.

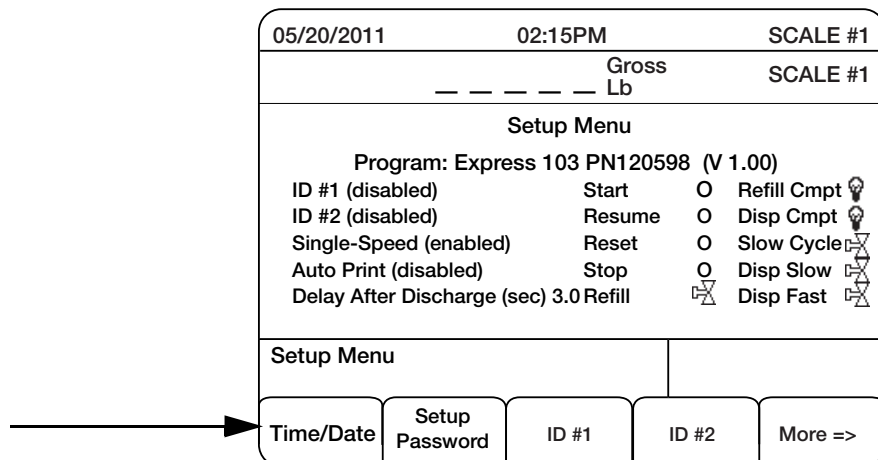

Figure 3-3. Select Time/Date Softkey

2. Use the arrow keys and the numeric keypad on the 920i (Figure 1-1 on page 3) to modify the time and or date.
3. Press the **Enter** key to save your settings.

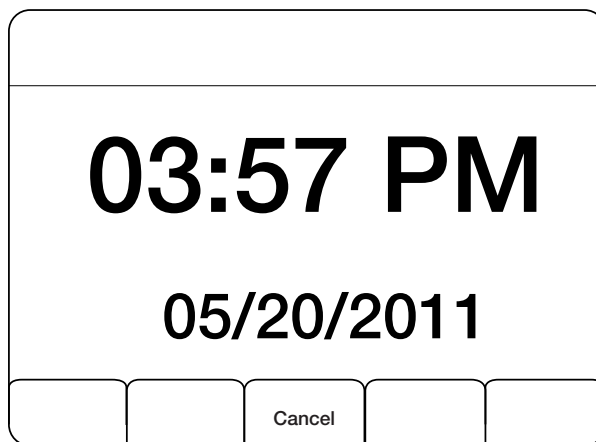

Figure 3-4. Time and Date Main Screen



**Note** The **Cancel** softkey can be pressed at any time to exit this sequence without saving any changes.

### 3.3 Modifying the Setup Password

Use the following steps to modify the setup password.

1. From the *Main Setup Menu Screen*, press the **Setup Password** softkey (Figure 3-2). The system prompts, *Enter New Password*.

05/20/2011	02:15PM	SCALE #1
Gross		SCALE #1
— — — — — Lb		
Setup Menu		
Program: Express 103 PN120598 (V 1.00)		
ID #1 (disabled)	Start	<input type="radio"/> Refill Cmpt
ID #2 (disabled)	Resume	<input type="radio"/> Disp Cmpt
Single-Speed (enabled)	Reset	<input type="radio"/> Slow Cycle
Auto Print (disabled)	Stop	<input type="radio"/> Disp Slow
Delay After Discharge (sec) 3.0	Refill	<input checked="" type="checkbox"/> Disp Fast
Enter New Password		
=>		
Home	Cancel	End

Figure 3-5. Enter New Password

2. Enter the new password and press the **Enter** key. The system prompts *Re-enter password* to verify.
3. Re-enter the password and press the **Enter** key again. The system performs one of the following actions.
  - If the passwords match, the system displays *Password Changed*.
  - If the passwords do not match, the system displays *Passwords Did Not Match* and exits the operation.

### 3.4 Enabling/Disabling Additional Data Fields

Use the following steps to enable or disable additional data fields.

1. From the *Main Setup Menu Screen*, press the **Setup Password** softkey (Figure 3-2).
2. Press the **ID #1** or **ID #2** softkey. The system displays *Enable Extra Data #1* or *Extra Data #2* while displaying **Yes** or **No** softkeys.

05/20/2011	02:18PM	SCALE #1
Gross		SCALE #1
— — — — — Lb		
Setup Menu		
Program: Express 103 PN120598 (V 1.00)		
ID #1 (disabled)	Start	<input type="radio"/> Refill Cmpt
ID #2 (disabled)	Resume	<input type="radio"/> Disp Cmpt
Single-Speed (enabled)	Reset	<input type="radio"/> Slow Cycle
Auto Print (disabled)	Stop	<input type="radio"/> Disp Slow
Delay After Discharge (sec) 3.0	Refill	<input checked="" type="checkbox"/> Disp Fast
Enable ID #1		
Yes	No	

Figure 3-6. Enabling ID's

3. The operator does one of the following.
  - Press the **Yes** softkey, the system prompts *Enter ID#1 Name*. Enter the name using the alpha keypad (press the UP arrow to access), and press the **Enter** key on the 920i. A new data field appears on the main display and as a softkey so that the operator can change it.
  - Press the **Yes** softkey and this returns the operator back to Step 1.

### 3.5 Modifying the Dispensing Speeds

Use the following steps to modify the dispensing speeds.

1. From the *Main Setup Menu Screen*, press the **Setup Password** softkey (Figure 3-2).
2. Press the **More =>** softkey to access the second and third menu screens.

05/20/2011	02:15PM	SCALE #1
Gross Lb		SCALE #1
Setup Menu		
Program: Express 103 PN120598 (V 1.00)		
ID #1 (disabled)	Start	<input type="radio"/> Refill Cmpt
ID #2 (disabled)	Resume	<input type="radio"/> Disp Cmpt
Single-Speed (enabled)	Reset	<input type="radio"/> Slow Cycle
Auto Print (disabled)	Stop	<input type="radio"/> Disp Slow
Delay After Discharge (sec) 3.0	Refill	<input checked="" type="checkbox"/> Disp Fast
Setup Menu		
<= More	Single-Spd Enabled	Auto Print Enabled
	Delay After Disch	More =>

Figure 3-7. Setup Main Menu Screen #2

3. Press the **Single Speed Enabled**, **Dual Speed Enabled** or **Parallel Speed Enabled** softkey. The system will toggle between the three modes of operation.

### 3.6 Modifying Auto Print

Use the following steps to modify the auto print.

1. From the *Main Setup Menu Screen*, press the **More =>** softkey to access the second setup menu screen.
2. Press the **Auto Print Enabled** or **Auto Print Disabled** softkey. The system will toggle between the two modes of operation.



Figure 3-8. Auto Print Disabled Softkey

## 3.7 Delay After Discharge

Use the following steps to modify the delay after discharge.

1. Cycle through pressing the **More =>** softkey to access the second setup menu screen which includes the Delay After Discharge softkey.

05/20/2011	02:15PM	SCALE #1
Gross Lb		SCALE #1
Setup Menu		
Program: Express 103 PN120598 (V 1.00)		
ID #1 (disabled)	Start	<input type="radio"/> Refill Cmpt
ID #2 (disabled)	Resume	<input type="radio"/> Disp Cmpt
Single-Speed (enabled)	Reset	<input type="radio"/> Slow Cycle
Auto Print (disabled)	Stop	<input type="radio"/> Disp Slow
Delay After Discharge (sec) 3.0 Refill	<input checked="" type="checkbox"/>	Disp Fast
Setup Menu		
<= More	Single-Spd Enabled	Auto Print Enabled
	Delay After Disch	More =>

Figure 3-9. Delay After Discharge Softkey Location

2. Press the **Delay After Discharge** softkey to access that softkey.

05/20/2011	02:19PM	SCALE #1
Gross Lb		SCALE #1
Setup Menu		
Program: Express 103 PN120598 (V 1.00)		
ID #1 (disabled)	Start	<input type="radio"/> Refill Cmpt
ID #2 (disabled)	Resume	<input type="radio"/> Disp Cmpt
Single-Speed (enabled)	Reset	<input type="radio"/> Slow Cycle
Auto Print (disabled)	Stop	<input type="radio"/> Disp Slow
Delay After Discharge (sec) 3.0 Refill	<input checked="" type="checkbox"/>	Disp Fast
Enter Delay After Disch (sec)		
=> 3.0		
Home	Cancel	End

Figure 3-10. Enter Time

3. Enter in the time in seconds to delay the discharge time.

### 3.7.1 Test Digital IO

1. Cycle through pressing the **More =>** softkey to access the third setup menu screen which includes the Delay After Discharge softkey.
2. Press the **Test Digital IO** softkey to test the Dispense Complete, Slow Dispense and Fast Dispense relay outputs.

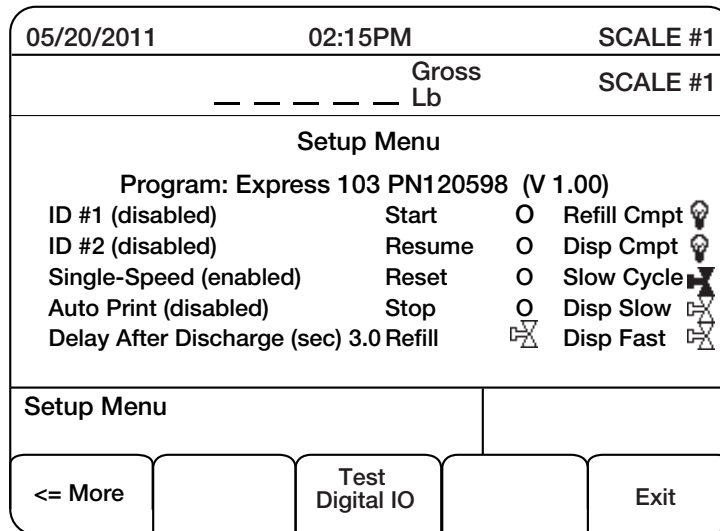



Figure 3-11. Test Digital I/O

#### Dispense Complete

Press the Dispense Complete softkey to test the digital I/O.

#### Slow Dispense

By pressing the Slow Dispense softkey, the digital I/O is tested and the Slow Dispense icon on the setup menu screen is darkened  while it's being tested. Press the Slow Dispense softkey again and the icon clears again.

#### Fast Dispense

By pressing the Fast Dispense softkey, the digital I/O is tested and the Fast Dispense icon on the setup menu screen is darkened  while it's being tested. Press the Fast Dispense softkey again and the icon clears again.

#### Refill

By pressing the Refill softkey, the digital I/O is tested and the Refill icon on the setup menu screen is darkened  while it's being tested. Press the Refill softkey again and the icon clears again.

#### Refill Complete

By pressing the Refill Complete softkey, the digital I/O is tested and the Refill Complete icon on the setup menu screen is darkened  while it's being tested.

#### Slow Cycle

By pressing the Slow Cycle softkey, the digital I/O is tested and the Slow Cycle icon on the setup menu screen is darkened  while it's being tested.



## 4.0 Operation

The section describes the basic sequence of operation for the FlexWeigh System 103.

### 4.1 Entering Presets Softkey Menu

The FlexWeigh System 103 has the capability to allow the operator to modify the presets/weights. See the following procedure:



**Note** The front panel E-stop button must be in the stopped position (pushed in) to enable the following keypad entries.

05/20/2011		10:21AM		SCALE #1	
Gross Lb				SCALE #1	
Target	Dribble	Preact	High Level	Low Level	
100.0 Lb	75	0.0	500 Lb	150 Lb	
Consec. #		Subtotal		Total	
2		0.0 Lb		3468 Lb	
Presets			Totals	Setup Menu	

Figure 4-1. Presets Menu Screen

1. Press the **Presets** softkey. The softkeys shown in Figure 4-2 are available.

05/20/2011		10:22AM		SCALE #1	
Gross Lb				SCALE #1	
Target	Dribble	Preact	High Level	Low Level	
100.0 Lb	75	0.0	500 Lb	150 Lb	
Consec. #		Subtotal		Total	
2		0.0 Lb		0.0 Lb	
Target Weight	Dribble Weight	Preact Weight	More =>	Exit	

Figure 4-2. Presets Softkey Parameters

2. Press the corresponding softkey to edit the data. Parameters that can be edited include:
  - Target weight
  - Dribble weight
  - Preact weight
  - High level weight
  - Low level weight
  - Slow cycle time

### 4.1.1 Target Weight

This is the desired weight value for a final dispense weight.

1. Enter the target weight using the arrow keys and the numeric keypad.
2. Press **Enter** on the 920i to save that value.

05/20/2011		10:24AM		SCALE #1	
Gross Lb				SCALE #1	
- - - - -					
Target	Dribble	Preact	High Level	Low Level	
100.0 Lb	75	0.0	500 Lb	150 Lb	
<b>Enter Target Weight</b>					
Consec. #		Subtotal		Total	
2		0.0 Lb		0.0 Lb	
Enter Target Weight => 100.0					
Home		Cancel		End	

Figure 4-3. Enter Target Weight

### 4.1.2 Dribble Weight

When a 2-speed dispense is enabled (either Parallel or Sequential), this is the desired weight value below the Target Weight that the cycle switches from Fast Feed to Dribble Feed.

1. Enter the dribble weight using the arrow keys and numeric keypad.
2. Press **Enter** on the 920i to save that value.

05/20/2011		10:25AM		SCALE #1	
Gross Lb				SCALE #1	
- - - - -					
Target	Dribble	Preact	High Level	Low Level	
100.0 Lb	75	0.0	500 Lb	150 Lb	
<b>Enter Dribble Weight</b>					
Consec. #		Subtotal		Total	
2		0.0 Lb		0.0 Lb	
Enter Dribble Weight => 0.0					
Home		Cancel		End	

Figure 4-4. Enter Dribble Weight

### 4.1.3 Preact Weight

Preact weight allows material to cut off prior to the original target value to allow for free fall material to settle onto the scale.

1. Enter the preact weight using the arrow keys and the numeric keypad.
2. Press **Enter** on the 920i to save that value.

05/20/2011		10:27AM		SCALE #1	
Gross Lb — — — — —				SCALE #1	
Target	Dribble	Preact	High Level	Low Level	
100.0 Lb	75	0.0	500 Lb	150 Lb	
<b>Enter Preact Weight</b>					
Consec. #		Subtotal		Total	
2		0.0 Lb		0.0 Lb	
Enter Preact Weight => 0.0					
Home		Cancel		End	

Figure 4-5. Enter Preact Weight

### 4.1.4 High Level Weight

This is the weight which the system dispenses material and considers the scale to be full. The scale weight must be above this value before the 920i will start a batch.

1. Enter the high level weight using the arrow keys and the numeric keypad.
2. Press **Enter** on the 920i to save that value.

05/20/2011		10:27AM		SCALE #1	
Gross Lb — — — — —				SCALE #1	
Target	Dribble	Preact	High Level	Low Level	
100.0 Lb	75	0.0	500 Lb	150 Lb	
<b>Enter High Level Weight</b>					
Consec. #		Subtotal		Total	
2		0.0 Lb		0.0 Lb	
Enter High Level Weight => 500.0					
Home		Cancel		End	

Figure 4-6. High Level Weight

### 4.1.5 Low Level Weight

After completing the first Dispense following a system power-up, if the displayed gross weight is below Low Level Weight, then the Refill output will automatically turn on until the gross weight exceeds High Level Weight. Starting a new dispense cycle will be inhibited during the time Refill output is on.

1. Enter the low level weight using the arrow keys and the numeric keypad.
2. Press **Enter** on the 920i to save that value.



**Note** Entering a Low Level Weight of zero ("0") disables automatic refill upon Low Level.

### 4.1.6 Slow Cycle Time

If a refill or dispense is not complete within the slow cycle time, the system will turn off all outputs and remain in a paused state.

1. Enter the desired slow cycle time using the arrow keys and the numeric keypad.
2. Press **Enter** on the 920i to save that value.



**Note** Entering a timer value of zero (0) disables the Slow Cycle Timer function.

05/20/2011		10:27AM		SCALE #1	
Gross Lb				SCALE #1	
Target	Dribble	Preact	High Level	Low Level	
100.0 Lb	75	0.0	500 Lb	150 Lb	
Enter Cycle Time (sec)					
Consec. #		Subtotal		Total	
2		0.0 Lb		0.0 Lb	
Enter Cycle Time (sec)					
=> 12.0					
Home		Cancel		End	

Figure 4-7. Enter the Cycle Time

### 4.1.7 Exit

Press the **Exit** softkey to leave the presets menu parameters.

## 4.2 Entering Totals Softkey Menu



**Note** Note that the front panel E-stop button must be in the stopped position to enable the following keypad entries.

05/20/2011		10:21AM		SCALE #1	
Gross Lb				SCALE #1	
Target	Dribble	Preact	High Level	Low Level	
100.0 Lb	75	0.0	500 Lb	150 Lb	
Enter Cycle Time (sec)					
Consec. #		Subtotal		Total	
2		0.0 Lb		3468 Lb	
Enter Cycle Time (sec)					
=> 12.0					
Presets			Totals	Setup Menu	

Figure 4-8. Printing and Clearing Accumulators Menu

1. Press the **Totals** softkey.
2. The operator can print and reset the consecutive number, subtotal and totals by pressing the appropriate softkey. Parameters that can be edited include:
  - Consecutive Number
  - Print Sub Total
  - Print Total

### 4.2.1 Consecutive Number

1. Press the Consecutive Number softkey to enter the next number to be weighed. The system keeps incrementing every time a batch is running (counter).

05/20/2011		10:22AM		SCALE #1	
■ ■ ■ ■ ■ Gross Lb				SCALE #1	
Target	Dribble	Preact	High Level	Low Level	
100.0 Lb	75	0.0	500 Lb	150 Lb	
<b>Enter Consecutive Number</b>					
Consec. #		Subtotal		Total	
2		0.0 Lb		0.0 Lb	
Enter Consecutive Number => 2					
Home		Cancel		End	

Figure 4-9. Enter Consecutive Number

### 4.2.2 Print Sub Total

1. Press the **Totals** softkey (Figure 4-8) to access the Print Sub Total softkey.
2. Press the **Print Sub Total** softkey to access the following screen.

05/20/2011		10:29AM		SCALE #1	
■ ■ ■ ■ ■ Gross Lb				SCALE #1	
Target	Dribble	Preact	High Level	Low Level	
100.0 Lb	75	0.0	500 Lb	150 Lb	
<b>Clear Sub Total?</b>					
Consec. #		Subtotal		Total	
2		0.0 Lb		0.0 Lb	
Yes				No	

Figure 4-10. Clear Sub Total Screen

3. Press the **Yes** softkey to clear the subtotal of the batch.  
Press the **No** softkey to exit out of the screen.

### 4.2.3 Print Total

1. Press the **Totals** softkey (Figure 4-8) to access the Print Total softkey.
2. Press the **Print Total** softkey to access the following screen.

05/20/2011		10:31AM		SCALE #1	
			Gross		SCALE
			Lb		#1
Target	Dribble	Preact	High Level	Low Level	
100.0 Lb	75	0.0	500 Lb	150 Lb	
<b>Clear Total?</b>					
Consec. #		Subtotal		Total	
2		0.0 Lb		0.0 Lb	
Yes				No	

Figure 4-11. Clear Total Screen

3. Press the **Yes** softkey to clear the total and sub-total of the batch.  
Press the **No** softkey to exit out of the screen.

### 4.3 Dispensing Material from a Scale

1. Press the **Start** button on the unit. The system verifies if:
  - E-Stop is pulled out
  - A valid target weight is entered

The system verifies the weight to make sure it's above the target weight and above the low level weight. If the weight is below the low level weight, it will refill the scale to the high level weight. When the weight reaches the high level weight, the refill output will turn off.

2. Press the **START** button to start the dispensing material.

The system does the following during this process.

- Turns off the Dispense Complete and Refill Complete outputs
- Increments the consecutive number by one
- Tares the scale to zero (net mode)

The system begins dispensing either of three speeds while the <Prodfont>920i screen displays real time sequence progress. The displayed net weight will continue showing more negative as weight is dispensed, until the target weight presets are achieved.

05/20/2011		10:28AM		SCALE #1	
<b>250</b>			Gross Lb		SCALE #1
<b>Target</b>	<b>Dribble</b>	<b>Preact</b>	<b>High Level</b>	<b>Low Level</b>	
100.0 Lb	75	0.0	500 Lb	150 Lb	
<b>Fast Dispense</b>					
<b>Consec. #</b>		<b>Subtotal</b>		<b>Total</b>	
2		120 Lb		3200 Lb	
<div style="display: flex; justify-content: space-around;"> <div style="border: 1px solid black; width: 40px; height: 20px;"></div> <div style="border: 1px solid black; width: 40px; height: 20px;"></div> <div style="border: 1px solid black; width: 40px; height: 20px;"></div> <div style="border: 1px solid black; width: 40px; height: 20px;"></div> <div style="border: 1px solid black; width: 40px; height: 20px;"></div> </div>					

Figure 4-12. Dispense Screen

The three dispensing speeds include:

- Single speed dispensing - The system turns on fast dispense until the target weight/preact weight is satisfied.
- Parallel speed dispensing - Turns on the fast dispense and slow dispense until the dribble weight is satisfied. The system then turns off the fast dispense and leaves the slow dispense on until the target weight/preact weight is satisfied.
- Dual speed dispensing - Turns on the fast dispense until the dribble weight is satisfied. The system turns on the slow dispense until the target weight/preact weight is satisfied.

The system does the following when the target/preact is reached.

- Turns off the output based on the dispensing mode
- Update the subtotal weight and number of dispenses
- Updates the total and number of dispenses
- Turns on the Dispense Complete output

The system delays for the Delay After Dispense time. After the delay, the weight display then switches to gross weight and:

- If the gross weight is below low level weight the Refill output will automatically turn on until the gross weight exceeds the high level weight.
- If the gross weight is above low level weight system, the system resets for the next cycle beginning with Step #1.

#### 4.4 Pausing/Resume/Reset a Dispense

1. Press the **E-Stop** button. System turns off all outputs and displays *System Paused*.
2. Press the **Resume** switch to resume where the current batch left off.
3. Press the **Reset** switch to return to Step 1 to start over.

## 4.5 Audit Trail Print

Record keeping is an important part of any system. The FlexWeigh System 103 has the ability to be connected to a printer for retaining detailed records on batches, cycle runs, cycle paused, etc.

The preferred printer to integrate with the FlexWeigh System 103 is the TMU-220 Tape Printer but will easily integrate with any strip printer.

Hook up the printer to the FlexWeigh System 103 per printer manual instructions.

Shown below are tape samples that can be printed using the FlexWeigh System 103 and the TMU-220 Tape Printer.

```

Start Cycle  6 04:31PM 04/27/2011
Id AB123 Location Rice Lake

End Cycle
 111.2 lb  04:31PM 04/27/2011

Start Cycle  7 04:32PM 04/27/2011
Id AB123 Location Rice Lake

Cycle Stopped  04:32PM 04/27/2011

Cycle Resumed 04:32PM 04/27/2011

End Cycle
 114.0 lb  04:32PM 04/27/2011

Start Cycle  8 04:32PM 04/27/2011
Id AB123 Location Rice Lake

Cycle Stopped  04:32PM 04/27/2011

Cycle Reset   04:32PM 04/27/2011

```

**Batch Stopped & Resume & Reset Print**

```

Sub Total      04:32PM 04/27/2011
Id AB123 Location Rice Lake
 7 cycles      755.8 lb

```

**Sub Total Printout**

```

Total          04:34PM 04/27/2011
Id AB123 Location Rice Lake
 9 cycles      1022.9 lb

```

**Total Printout**

```

Start Cycle  1 04:03PM 04/27/2011

End Cycle
 111.1 lb  04:03PM 04/27/2011

Start Cycle  2 04:03PM 04/27/2011

End Cycle
 104.9 lb  04:03PM 04/27/2011

```

**No Extra ID Fields Running Batch Print**

```

Start Cycle  3 04:07PM 04/27/2011
Id AB123 Location Rice Lake

End Cycle
 100.7 lb  04:07PM 04/27/2011

Start Cycle  4 04:07PM 04/27/2011
Id AB123 Location Rice Lake

End Cycle
 109.1 lb  04:07PM 04/27/2011

Start Cycle  5 04:07PM 04/27/2011
Id AB123 Location Rice Lake

End Cycle
 102.8 lb  04:08PM 04/27/2011

```

**2 Extra ID Fields Running Batch Printout**

Figure 4-13. Tape Printer Example



## 5.0 Appendix

---

The section provides additional information for the FlexWeigh System 103.

### 5.1 Options

Several options are available with the FlexWeigh System 103. Those options that are available include:

- Auto-Mode Front Panel Controls
- Manual-Mode Front Panel Controls
- Optional Front Panel Pilot Lights

#### Three Position Selector Switch

Includes:

- Manual/Off/Auto

#### Manual Mode Front Panel Push Button

Includes:

- Manual Dispense

#### Maintained/Off/Spring Return Manual Switches

- Dispense - On/Jog
- Dispense - Fast/Slow
- Refill - On/Jog

#### Optional Front Panel Event Pilot Lights

Includes:

- Amber Dispense
- Amber Dispense Fast
- Amber Dispense Slow
- Red Dispense Complete
- Blue Refilling
- Red Refill Complete
- Red Low Supply
- Red Fill Time Alarm

### 5.2 FCC Compliance

#### United States

This equipment has been tested and found to comply with the limits for a Class A digital device, pursuant to Part 15 of the FCC Rules. These limits are designed to provide reasonable protection against harmful interference when the equipment is operated in a commercial environment. This equipment generates, uses, and can radiate radio frequency energy and, if not installed and used in accordance with the instruction manual, may cause harmful interference to radio communications. Operation of this equipment in a residential area is likely to cause harmful interference in which case the user will be required to correct the interference at his own expense.

#### Canada

This digital apparatus does not exceed the Class A limits for radio noise emissions from digital apparatus set out in the Radio Interference Regulations of the Canadian Department of Communications.

Le présent appareil numérique n'émet pas de bruits radioélectriques dépassant les limites applicables aux appareils numériques de la Class A prescrites dans le Règlement sur le brouillage radioélectrique édicté par le ministère des Communications du Canada.

### 5.2.1 Radio Certificate Numbers

- US: R68WIPORTG
- Canada: 3867A-WIPORTG

### 5.3 Product Dimensions

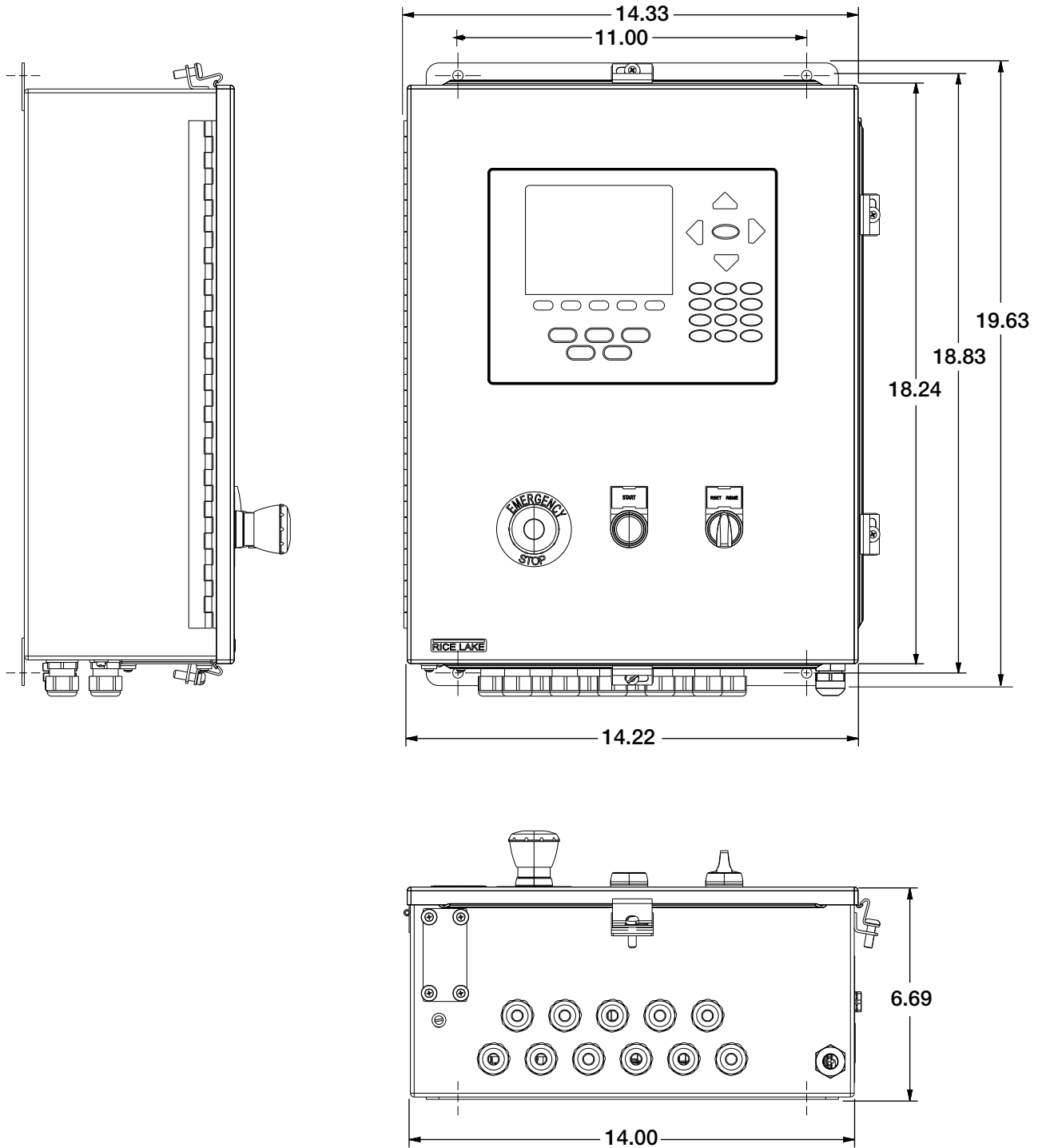

Figure 5-1. FlexWeigh System 103 Basic Filler Enclosure Dimensions

## 5.4 Replacement Parts

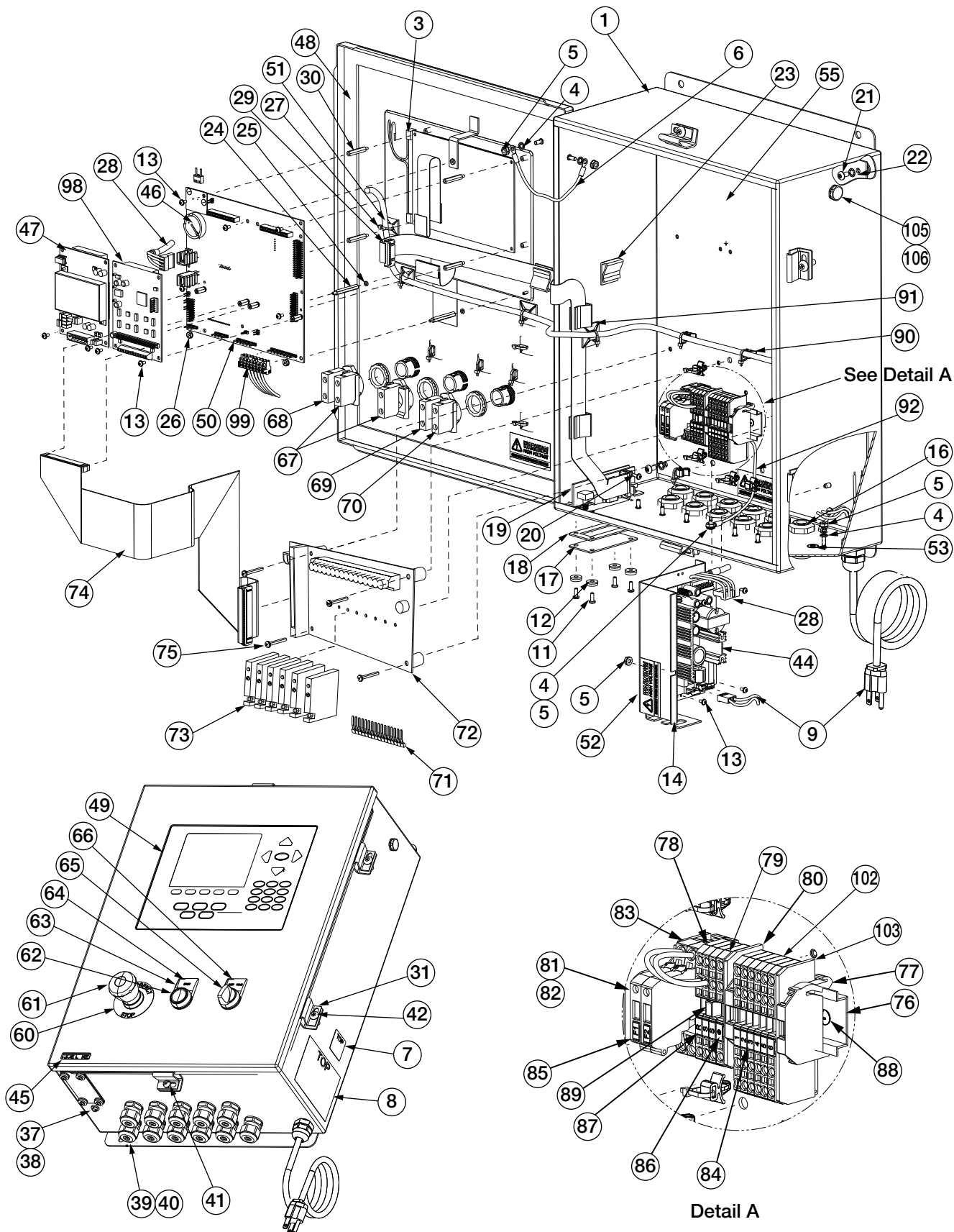

Figure 5-2. Replacement Parts Illustration

Item No	Part No	Description (Quantity)	Qty
1	120417	Enclosure, Wall Mount	1
3	67614	Display, LCD Module, 920i	1
4	15134	Lock Washers, No 8, Type A	4
5	14626	Kep Nuts, 8-32NC Hex	4
6	15601	Ground Wire, 6 in w/No. 8	1
7	53308	Label, 1.25 x 1.25 8000T	1
8	53307	Label, 4.000 x 2.875	1
9	85202	Power Cord Assembly, 120 VAC	1
11	14845	Machine Screws, 6-32NC x 3/8	8
12	45042	Washer, Bonded Sealing SS	8
13	14822	Machine Screws, 4-40NC x 1/4	13
14	69538	Power Supply Bracket	1
16	15630	Locknuts, 1/2 NPT Black	11
17	67530	Interface Board Plate	1
18	67535	Interface Board Gasket	1
19	67869	920i Interface Board	1
20	55708	Machine Screws, 4-40NC x 3/8	2
21	14875	Machine Screws, 10-32NF x 3/8	4
22	15140	Lock Washer, No. 10, Type A	4
23	46192	Flat Ribbon Cable Clamp	4
24	68661	Standoffs, Male-FEM, 4-40NC	2
25	69898	Nylon Washer ID 0.112	2
26	14618	Kep Nuts, 4-40NC Hex	2
27	15631	Cable Tie, 3 in Nylon	18
28	71431	Cable Assembly, 65W power	1
29	71436	Ribbon Cable Assembly, 28 in	1
30	67886	Standoffs, Long, Male 4-40NC	4
31	71739	Cinching Enclosure Clip	4
37	42640	Machine Screw, 1/4 - 28NF x 1	1
38	59250	Washer, .255 ID x .437 OD	1
39	30376	Sealing Ring, 1/2 NPT, Nylon	11
40	15628	Cord Grip, 1/2 NPT, Black	11
41	71455	Machine Screws, 1/4-28NF x .75	1
42	71447	Machine Screws 1/4-28NF	3
44	71333	920i Power Supply Board	1
45	68216	Metal Nameplate	1
46	69290	3V Coin Lithium Batter	1
47	67610	Single Channel A/D Card	1
48	68724	920i Cover Gasket	1
49	66502	Overlay, Membrane Switch	1
50	109549	920i CPU Board Assembly	1
51	15650	Cable Tie Mount 3/4 in	7
52	16861	Label, High Voltage	3

Item No	Part No	Description (Quantity)	Qty
53	16892	Label, Earth Ground	1
55	120423	Back Panel Component	1
60	94274	Legend Plate, Emergency Stop	1
61	94273	Red Mushroom Switch	1
62	94277	Switch, Push Button Green	1
63	94316	Legend Plate Holder	2
64	114695	Legend Plate, Start	1
65	94298	3-Position Switch	1
66	120728	Legend Plate, Reset/Resume	1
67	94310	Contact Block	2
68	94311	Contact Block, Switch On	1
69	94312	Contact Block, Switch On	1
70	94313	Contact Block, Switch On	1
71	41035	16 Position Jumper Strap	1
72	33207	8-Channel Mounting Relay Board	1
73	15971	Output Relay Module	6
74	70780	50 Pin Flat Ribbon Cable	1
75	120762	Machine Screw, 6-32NC x 1 - 1/4	4
76	43636	DIN Rail	1
77	61141	Screwless WAGO End Stop	3
78	62964	WAGO Terminal Block	7
79	62966	WAGO Terminal Block	1
80	62968	Intermediate End Plate	3
81	62969	WAGO Fuse Terminal Block	2
82	54215	Time Delay Fuse, 3.15 amp	2
83	66190	Intermediate End Plate	1
84	62959	Label, WAGO Terminal Strip	1
85	65007	Label, WAGO Terminal Block	1
86	62967	Label, WAGO Terminal Block	1
87	66034	Label, WAGO Terminal Block	1
88	22087	Machine Screw, 6-32NC x 3/8	2
89	55337	Jumper, Series 280, Insulated	1
90	80590	Arrowhead Cable Tie Mount	8
91	15658	1 Inch Cable Tie Mount	2
92	121069	9 Inch Ground Assembly Wire	1
98	67608	Card, Digital I/O	1
99	77180	Conn, 8 Pos Screw Terminal	1
102	62975	Plate, End Intermediate	1
103	62973	Block, Terminal WAGO 4	6
105	88733	Vent, Breather Sealed	1
106	88734	Nut, Breather Vent	1
NS	54215	Fuse Between Din Rail/Relay Rack	1
NS	117901	Foam, Mixture High Density	1

Table 5-1. Replacement Parts List

## 6.0 Limited Warranty

---

Rice Lake Weighing Systems warrants that all Rice Lake Weighing Systems equipment and systems properly installed by a Distributor or Original Equipment Manufacturer (OEM) will operate per written specifications as confirmed by the Distributor/OEM and accepted by Rice Lake Weighing Systems. All systems and components are warranted against defects in materials and workmanship for two years.

Rice Lake Weighing Systems warrants that the equipment sold hereunder will conform to the current written specifications authorized by Rice Lake Weighing Systems. Rice Lake Weighing Systems warrants the equipment against faulty workmanship and defective materials. If any equipment fails to conform to these warranties, Rice Lake Weighing Systems will, at its option, repair or replace such goods returned within the warranty period subject to the following conditions:

- Upon discovery by Buyer of such nonconformity, Rice Lake Weighing Systems will be given prompt written notice with a detailed explanation of the alleged deficiencies.
- Individual electronic components returned to Rice Lake Weighing Systems for warranty purposes must be packaged to prevent electrostatic discharge (ESD) damage in shipment.
- Examination of such equipment by Rice Lake Weighing Systems confirms that the nonconformity actually exists, and was not caused by accident, misuse, neglect, alteration, improper installation, improper repair or improper testing; Rice Lake Weighing Systems shall be the sole judge of all alleged non-conformities.
- Such equipment has not been modified, altered, or changed by any person other than Rice Lake Weighing Systems or its duly authorized repair agents.
- Rice Lake Weighing Systems will have a reasonable time to repair or replace the defective equipment. Buyer is responsible for shipping charges both ways.
- In no event will Rice Lake Weighing Systems be responsible for travel time or on-location repairs, including assembly or disassembly of equipment, nor will Rice Lake Weighing Systems be liable for the cost of any repairs made by others.



These warranties exclude all other warranties, expressed or implied, including without limitation warranties of merchantability or fitness for a particular purpose. Neither Rice Lake Weighing Systems or distributor will, in any event, be liable for incidental or consequential damages.

Rice Lake Weighing Systems and buyer agree that Rice Lake Weighing Systems's sole and exclusive liability hereunder is limited to repair or replacement of such goods. In accepting this warranty, the buyer waives any and all other claims to warranty.

Should the seller be other than Rice Lake Weighing Systems, the buyer agrees to look only to the seller for warranty claims.

No terms, conditions, understanding, or agreements purporting to modify the terms of this warranty shall have any legal effect unless made in writing and signed by a corporate officer of Rice Lake Weighing Systems and the Buyer.

## 7.0 Compliance

	<b>EU DECLARATION OF CONFORMITY</b> <i>EU-KONFORMITÄTSERKLÄRUNG</i> <i>DÉCLARATION UE DE CONFORMITÉ</i>		Rice Lake Weighing Systems 230 West Coleman Street Rice Lake, Wisconsin 54868 United States of America
			
<b>Type/Typ/Type:</b> 820i and 920i series			
English	We declare under our sole responsibility that the products to which this declaration refers to, is in conformity with the following standard(s) or other regulations document(s).		
Deutsch	Wir erklären unter unserer alleinigen Verantwortung, dass die Produkte auf die sich diese Erklärung bezieht, den folgenden Normen und Regulierungsbestimmungen entsprechen.		
Francais	Nous déclarons sous notre responsabilité que les produits auxquels se rapporte la présente déclaration, sont conformes à la/aux norme/s suivante ou au/aux document/s normatif/s suivant/s.		
EU Directive	Certificates	Standards Used / Notified Body Involvement	
2014/30/EU EMC	-	EN 61326-1:2013, EN 55011:2009+A1:2010, EN 61000-6-1:1995, EN 61000-6-2:2007	
2014/35/EU LVD	-	IEC 60950-1 ed.2	
2011/65/EU RoHS	-	EN 50581:2012	
Signature:			Place: <u>Rice Lake, WI USA</u>
Type Name:	<u>Richard Shipman</u>		Date: <u>May 3, 2019</u>
Title:	<u>Quality Manager</u>		

**UK  
CA****UK DECLARATION  
OF CONFORMITY**Rice Lake Weighing Systems  
230 West Coleman Street  
Rice Lake, Wisconsin 54868  
United States of America**RICE LAKE**  
WEIGHING SYSTEMS**Type:** 820i and 920i series

English We declare under our sole responsibility that the products to which this declaration refers to, is in conformity with the following standard(s) or other regulations document(s).

UK Regulations	Certificates	Standards Used / Approved Body Involvement
2016/1101 Low Voltage	-	IEC 60950-1 ed.2
2016/1091 EMC	-	EN 61326-1:2013, EN 55011:2009+A1:2010, EN 61000-6-1:1995, EN 61000-6-2:2007
2012/3032 RoHS	-	EN 50581:2012

Signature: Brandi HarderPlace: Rice Lake, WI USAName: Brandi HarderDate: December 30, 2021Title: Quality Manager









© Rice Lake Weighing Systems Specifications subject to change without notice.

230 W. Coleman St. • Rice Lake, WI 54868 • USA

U.S. 800-472-6703 • Canada/Mexico 800-321-6703 • International 715-234-9171 • Europe +31 (0)26 472 1319