

CARDINAL

CARDINAL®

Cardinal Price Index By Rice Lake Weighing Systems PN

CARDINAL®

RL PN SUGGESTED LIST	PAGE #	RL PN SUGGESTED LIST	PAGE #	RL PN SUGGESTED LIST	PAGE #			
10029	\$203.00	225	109640	\$33.00	224	CM738	\$102.00	225
15232	\$2.00	XX	109641	\$40.00	224	CM739L	\$113.00	226
15263	\$1.10	223	109642	\$48.00	224	CM740	\$203.00	225
15266	\$2.00	Not Shown	109643	\$50.00	224	CM741	\$203.00	225
15274	\$1.00	223	109644	\$74.00	224	CM742P	\$47.00	218
15285	\$1.00	223	111251	\$393.00	228	CM743P	\$48.00	218
15295	\$3.00	Not Shown	154029	\$21.00	222	CM744P	\$47.00	218
15297	\$3.00	Not Shown	154030	\$22.00	222	CM745P	\$55.00	218
15306	\$8.00	Not Shown	156479	\$117.00	226,228	CM746P	\$28.00	219
22005	\$0.35	XX	CM701	\$42.00	223	CM747	\$73.00	223
22100	\$2.50	Not Shown	CM702	\$57.00	223	CM748P	\$74.00	224
44793	\$57.00	220	CM703P	\$33.00	224	CM749	\$244.00	225
46285	\$69.00	219	CM704P	\$50.00	224	CM750	\$54.00	218
46296	\$46.00	220	CM705	\$41.00	223	CM751	\$59.00	218
46299	\$225.00	221	CM706	\$41.00	223	CM752	\$55.00	218
46302	\$120.00	221	CM707	\$53.00	223	CM753	\$46.00	218
46307	\$50.00	219	CM708	\$55.00	223	CM754	\$46.00	218
46323	\$85.00	220	CM709	\$61.00	223	CM755	\$53.00	220
65351	\$65.00	219	CM710P	\$31.00	224	CM756	\$107.00	222
66219	\$274.00	227	CM711P	\$32.00	224	CM757	\$62.00	218
67297	\$987.00	229	CM712P	\$40.00	224	CM759	\$117.00	224
67497	\$120.00	229	CM713P	\$48.00	224	CM761P	\$31.00	219
69431	\$63.00	229	CM714P	\$63.00	224	CM762P	\$25.00	219
71005	\$46.00	220	CM715L	\$117.00	226	CM763	\$37.00	220
71006	\$117.00	218	CM715L-2	\$14.00	Not Shown	CM764	\$41.00	220
71008	\$47.00	220	CM716	\$239.00	225	CM765	\$368.00	227
89095	\$125.00	226,228	CM716-1	\$11.00	Not Shown	CM766	\$96.00	225
89099	\$141.00	225,228	CM717	\$115.00	225	CM767	\$368.00	227
89102	\$86.00	229	CM718	\$95.00	222	CM768	\$140.00	226
89103	\$167.00	229	CM719	\$72.00	222	CM769	\$228.00	221
89137	\$193.00	229	CM720	\$75.00	222	CM769-2	\$70.00	220
89223	\$234.00	225	CM721	\$24.00	222	CM770P	\$91.00	219
89286	\$132.00	221	CM725P	\$32.00	219	CM771	\$239.00	225
89289	\$141.00	226	CM726	\$46.00	219	CM772L	\$117.00	226
89438	\$76.00	228	CM727	\$87.00	221	CM773	\$93.00	221
89455	\$213.00	222	CM728	\$82.00	221	CM775L	\$113.00	226
89466	\$393.00	228	CM729	\$132.00	221	CM776	\$241.00	221
89728	\$72.00	228	CM730P	\$82.00	224	CM777	\$54.00	220
90815	\$18.00	222	CM731	\$99.00	223	CM778P	\$49.00	220
90836	\$17.00	222	CM732	\$32.00	220	CM779	\$399.00	227
90846	\$15.00	222	CM733	\$159.00	221	CM783	\$209.00	221
91765	\$1,195.00	228	CM734P	\$42.00	219	CM784L	\$123.00	226
94458	\$29.00	222	CM735P	\$44.00	219	CM785	\$361.00	227
94459	\$37.00	222	CM736	\$53.00	219	CM787	\$63.00	218
109639	\$31.00	224	CM737	\$343.00	227	CM789P	\$55.00	218

*Item obsolete or discontinued. When remaining stock is depleted, published prices are withdrawn and the item is subject to a special order quote.

XX Call for details.



Cardinal Cross Reference By Equivalent Cardinal Number

EQUIV. CARDINAL #	RL PN	PAGE #	EQUIV. CARDINAL #	RL PN	PAGE #	EQUIV. CARDINAL #	RL PN	PAGE #
100-1465	67297	229	0119-C068	CM785	227	1401-B008-2	CM734P	219
0102-C011	156479	226,228	0309-B003	CM773	221	1401-B009-1	CM735P	219
0103-B120-08	89099	225,228	0309-B044 C25	SZ16951	XX	1401-B011-1	CM770P	219
0103-C204-OA	111251	228	0309-C003-3	SZ17269	XX	1411-B004	CM732	220
0105-C071-OA	156480	XX	0309-C007-61	CM776	221	1411-B005	CM755	220
0112-B242-08	89223	225	0309-C008-60	CM783	221	1411-B006	CM769-2	220
0113-B374-08	SZ19209	XX	0309-C149-OA	SZ16950	XX	1411-B007	CM726	219
0119-B127-53	CM719 CM720 CM721	222	0309-0150-OA	SZ16949	XX	1411-B008	CM757	218
0119-B007	CM715L	226	0409-B013	CM769	220,221	1412-B001-3	CM702	XX
0119-B018	CM716	225	0409-B015	CM733	221	1412-B001-5	CM747	223
0119-B019	CM717	225	0409-B027	CM728	221	1412-B001-7	CM731	223
0119-B022	CM749	225	0409-B028	CM727	221	1412-B001-9	CM701	223
0119-B025	CM738	225	0409-B029	CM729	221	1412-B001-13	CM708	223
0119-B026	CM740	225	0409-B040 C10	nose iron	XX	1412-B001-19	CM707	223
0119-B028	CM766	225	0409-B051	nose iron	XX	1412-B012-13	CM708	223
0119-B013-1	CM756	222	0604-B090	71006	218	1417-B001	CM750	218
0119-B103-2	CM718	222	1400-B001-5	CM712P	224	1417-B002	CM787	218
0119-B125-52	CM759	224	1400-B001-9	CM703P	224	1417-B003	CM751	218
0119-B127-52	CM719	222	1400-B001-13	CM710P	224	14SRF	CM771	225
0119-B127-52	CM720	222	1400-B001-19	CM704P	224	16SRF	CM715L	226
0119-B127-52	CM721	222	1400-B001-21	CM748P	224	17SRF	CM717	225
0119-B195	CM784L	226	1400-B001-25	CM713P	224	24SR	CM788	XX
0119-B197	CM749	225	1400-B001-21		XX	26SR	CM768L	XX
0119-C007	CM784L	226	1400-B001-27		XX	27SR	CM766	XX
0119-C008	CM767	227	1400-B001-29	CM730P	224	44SRF	CM741	225
0119-C009	CM765	227	1400-B004	CM761P	219	46SRF	CM775L	226
0119-C010	CM779	227	1400-B005	CM789P	218	47SRF	CM738	225
0119-C011	CM790 SZ5617	XX	1400-B006	CM742P	218	61353-3	CM733	221
0119-C013	CM780	227	1400-B007	CM744P	218	C-37	CM727	221
0119-C014	CM739L	226	1400-B008	CM743P	218	C-38	CM728	221
0119-C016	CM737	227	1400-B009	CM745P	218	C-39	CM729	221
0119-C017	CM768L	XX	1401-B006-1	CM762P	219	C113	CM769	221
0119-C019	CM788	XX	1401-B006-3	CM746P	219	D68	CM733	221
0119-0040	66219	227	1401-B007-2	CM725P	219	2993-B021-08	89728	228
						6020-0060	15263	223

*Item obsolete or discontinued. When remaining stock is depleted, published prices are withdrawn and the item is subject to a special order quote.

XX Call for details.

CARDINAL®

Individual Cardinal Scale Parts

Dormant Scale Parts

CARDINAL®

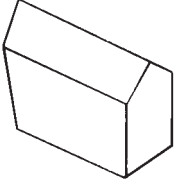
RICE LAKE PN	DESCRIPTION	SUGG. LIST	
CM744P	Equiv. Cardinal no. 1400-B007 Size: 3/8 in x 3/4 in x 1 in Pivot, tapered ends	\$47.00	
CM742P	Equiv. Cardinal no. 1400-B006 Size: 3/8 in x 3/4 in x 1 1/4 in Pivot	\$47.00	
CM743P	Equiv. Cardinal no. 1400-B008 Size: 3/8 in x 3/4 in x 1 7/8 in Pivot	\$48.00	
CM789P	Equiv. Cardinal no. 1400-B005 Size: 3/8 in x 3/4 in x 2 3/8 in Pivot, tapered ends	\$55.00	
CM745P	Equiv. Cardinal no. 1400-B009 Size: 3/8 in x 3/4 in x 2 3/4 in Pivot	\$55.00	
CM752	Equiv. Cardinal no. 265 R15 Size: 15/16 in x 15/16 in x 1 in Bearing	\$55.00	
CM753	Equiv. Cardinal no. 265 R225, 1411-B007 Size: 15/16 in x 15/16 in x 1 in Bearing	\$46.00	
CM754	Equiv. Cardinal no. 265 R219 Size: 7/8 in x 7/8 in x 11/16 in Bearing	\$46.00	
CM757	Equiv. Cardinal no. 1411-B008, 265 R217 Size: 15/16 in x 1 3/8 in x 2 1/2 in Hole size: .515 in Bearing	\$62.00	
CM750	Equiv. Cardinal no. 1400-B001, 265R110 Size: 1 in dia x 9/16 in Bearing	\$54.00	
CM751	Equiv. Cardinal no. 1417-B003, 265 R21 Size: 1 1/4 in dia x 1 in Bearing	\$59.00	
CM787	Equiv. Cardinal no. 1417-B002 Size: 2 in dia x 1 3/8 in Bearing	\$63.00	
71006	Equiv. Cardinal no. 0604-B090 Size: 1 5/8 in x 1 in x 4 1/4 in Center connection	\$117.00	

Individual Cardinal Scale Parts

Hopper Scale Parts

RICE LAKE PN	DESCRIPTION	SUGG. LIST
CM762P	Equiv. Cardinal no. 1401-B006-1 Size: 3/8 in x 3/8 in x 2 in Pivot	\$25.00
CM746P	Equiv. Cardinal no. 1401-B006-3 Size: 3/8 in x 3/8 in x 3 in Pivot	\$28.00
CM725P	Equiv. Cardinal no. 1401-B007-2 Size: 1/2 in x 1/2 in x 3 in Pivot	\$32.00
CM734P	Equiv. Cardinal no. 1401-B008-2 Size: 5/8 in x 5/8 in x 3 1/2 in Pivot	\$42.00
CM735P	Equiv. Cardinal no. 1401-B009-1 Size: 3/4 in x 3/4 in x 3 1/2 in pivot	\$44.00
65351	Equiv. Cardinal no. n/a Size: 3/4 in x 3/4 in x 3 1/2 in Pivot, stainless steel	\$65.00
CM770P	Equiv. Cardinal no. 1401-B011-1 Size: 1 in x 1 in x 5 in Pivot	\$91.00
46285	Pivot Size: 1 in dia x 3 1/2 in Use wedge 46286	\$69.00
CM761P	Equiv. Cardinal no. 1400-B004 Size: 1/4 in x 5/8 in x 7/8 in Pivot	\$31.00
46307	Equiv. Cardinal no. n/a Size: 1/4 in x 5/8 in x 7/8 in Pivot, stainless steel	\$50.00
CM726	Equiv. Cardinal no. 1411-B007 Size: 1 in x 7/8 in x 1 1/8 in Hole size: 21/64 in Bearing	\$46.00
CM736	Equiv. Cardinal no. n/a Size: 1 1/4 in x 1 in x 1 1/4 in Hole size: 25/64 in Bearing	\$53.00
89455	Equiv. Cardinal no. 0409-C017-OA Size: 1 1/4 in x 2 1/4 in x 9 3/8 in Center connection	\$213.00

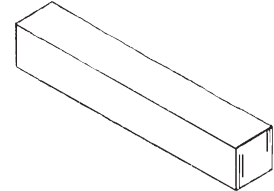

Must measure the size of old pivot with a micrometer. We will grind to size for CONSULT3.00 each

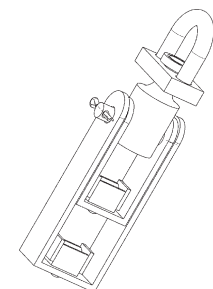
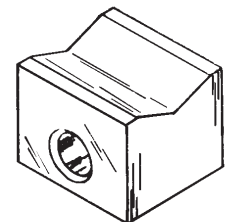
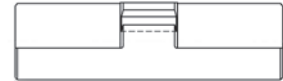



CARDINAL®

Individual Cardinal Scale Parts

Hopper Scale Parts (Cont.)

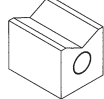
CARDINAL®

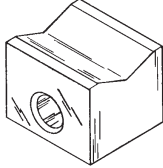
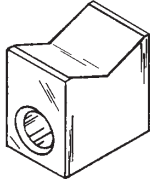
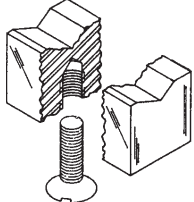
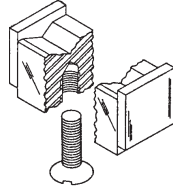
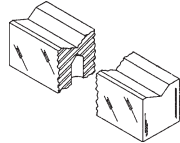
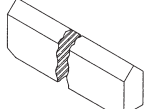
RICE LAKE PN	DESCRIPTION	SUGGESTED LIST	
71005	Equiv. Cardinal no. n/a Size: 1 in x 1 in x 1 1/4 in	\$46.00	
71008	Equiv. Cardinal no. n/a Size: 1 in x 1 1/4 in x 1 1/8 in With frictions	\$47.00	
CM755	Equiv. Cardinal no. 1411-B005 Size: 1 3/8 in x 15/16 in x 1 5/16 in Bearing	\$53.00	
46323	Equiv. Cardinal no. n/a Size: 1 3/8 in x 15/16 in x 1 5/16 in Bearings, stainless steel	\$85.00	
44793	Equiv. Cardinal no. n/a Size: 1 3/8 in x 1 3/8 in x 1 5/16 in Hole size: 3/8 in Bearing	\$57.00	
CM769-2	Equiv. Cardinal no. 1411-B006 Size: 1 3/4 in x 1 1/2 in x 1 13/16 in Hole size: 5/8 in Bearing	\$70.00	
CM732	Equiv. Cardinal no. 1411-B004 Size: 25/32 in x 25/32 in x 17/32 in Hole size: 1/4 in - offset Bearing	\$32.00	
CM763	Equiv. Cardinal no. n/a Size: 3/4 in x 3/4 in x 1 in Hole size: 1/4-20 thread Bearing Screw not included Use screw, Rice Lake PN 22005	\$37.00	
CM764	Equiv. Cardinal no. n/a Size: 3/4 in x 3/4 in x 1 1/4 in SST Hole size: 1/4-20 thread Bearing, with friction plates Screw not included Use screw, Rice Lake PN 22005	\$41.00	
46296		\$46.00	
CM777	Equiv. Cardinal no. n/a Size: 3/4 in x 3/4 in x 4 5/8 in Hole size: 1/4 in dia	\$54.00	
CM778P	Equiv. Cardinal no. n/a Size: 3/8 in x 3/4 in x 4 5/8 in Pivot	\$49.00	

Individual Cardinal Scale Parts

Hopper Scale Parts (Cont.)

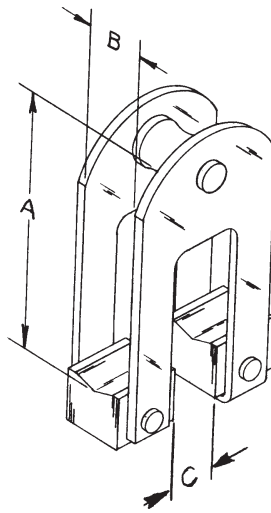
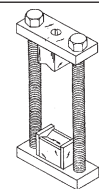
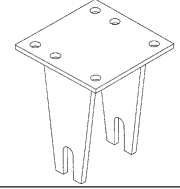
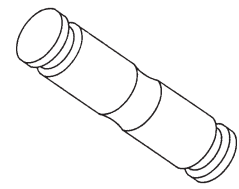
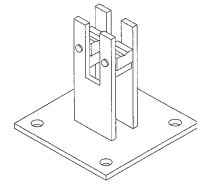

RICE LAKE PN	DESCRIPTION	SUGG. LIST	
CM728	Equiv. Cardinal no. C-38, 0409-B027 Size: A. 2 in B. 3/4 in C. 9/16 in Assembly includes CM732 bearings And Rice Lake PN 15266 pins	\$82.00	
CM727	Equiv. Cardinal no. C-37, 0409-B028 Size: A. 3 1/8 in B. 1 in C. 9/16 in Assembly includes Rice Lake PN CM726 Bearings and Rice Lake PN 22100 pins	\$87.00	
CM729	Equiv. Cardinal no. C-39, 0409-B029 Size: A. 4 in B. 1 3/8 in C. 1 in Assembly includes Rice Lake PN CM755 Bearings and Rice Lake PN 15295 pins Cotter pin pn15232	\$132.00	
46299	Equiv. Cardinal no. C-39, 0409-B029 Size: A. 4 in B. 1 3/8 in C. 1 in assembly includes bearing PN 46323 and pin PN 47992 stainless steel	\$225.00	
89286	Equiv. Cardinal no. Size A. 3 13/16 in B. 1 3/8 in C. 1 in New style CM729 with taller Bearings, PN 44793	\$132.00	
CM769	Equiv. Cardinal no. C113, 0409-B013 Size: A. 4 1/4 in B. 1 3/4 in C. 1 1/2 in Assembly includes Rice Lake PN CM769-2 Bearings and Rice Lake PN 15306 pins	\$228.00	
CM733	Equiv. Cardinal no. D68, 61353-3, 0409-B015 Size of plate: 1 in x 3/8 in x 2 3/4 in Size of bearing: 3/4 in x 3/4 in x 1 in Size of bolt: 3/8 in - 16 in x 6 in Upper bearing: Rice Lake PN CM763 Lower bearing: Rice Lake PN CM764	\$159.00	
CM776	Equiv. Cardinal no. 0309-C007-61 Base: 8 in x 8 in Total height: 10 1/2 in FS2.5, FS3, FS4 See page xxx for other chair	\$241.00	
CM773	Equiv. Cardinal no. 0309-B003 Size: 1 1/4 in dia x 5 1/4 in Trunnion pin FS2.5, FS3, FS4	\$93.00	
46302	Equiv. Cardinal no. Size: 1 1/4 in dia x 5 1/4 in SST Trunnion pin FS2.5, FS3, FS4	\$120.00	
CM783	Equiv. Cardinal no. 0309-C008-60 Base: 8 in x 8 in Total height: 8 in Assembly includes Rice Lake PN CM755 Bearings and Rice Lake PN 15297 pins FS2.5, FS3, FS4 See page 328 for other stands	\$209.00	

CARDINAL®

Individual Cardinal Scale Parts

Truck Scale Parts

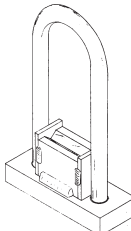
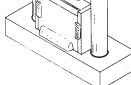
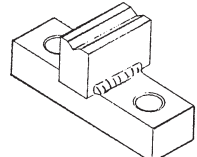
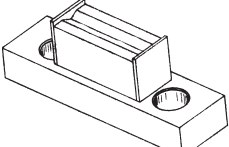
CARDINAL®

RICE LAKE PN	DESCRIPTION	SUGGESTED LIST	
CM718	Equiv. Cardinal no. 0119-B103-2 Size: bearing, 1 5/8 in long 3 1/4 in loop length, inside Transverse lever tip loop	\$95.00	
CM756	Equiv. Cardinal no. 0119-B103-1 Size: bearing, 2 1/8 in long 3 1/2 in inside loop length Transverse lever tip loop	\$107.00	
CM719	Equiv. Cardinal no. 0119-B127-52 Size: bearing, 2 1/8 in long Total length 5 in Between holes 3 1/4 in center to center Hole size: 11/16 in Upper center connection	\$72.00	
CM720	Equiv. Cardinal no. 0119-B127-52 Size: bearing, 2 1/8 in long Total length 5 in Between holes 3 1/4 in center to center Hole size: 11/16 in Lower center connection	\$75.00	
*CM721	Equiv. Cardinal no. 0119-B127-52 Size: 5/8 in dia x 18 in long Main lever shackle bolt Other bolts listed below	\$24.00	

*OTHER BOLTS AVAILABLE

RICE LAKE PN	DESCRIPTION	SUGGESTED LIST
154030.....	1/2 in - 13 x 16 in	\$22.00
90846.....	5/8 in - 11 x 8 in	\$15.00
90836.....	5/8 in - 11 x 13 in	\$17.00
90815.....	5/8 in - 11 x 16 in	\$18.00
CM721	5/8 in - 11 x 18 in	\$24.00
154029.....	3/4 in - 10 x 12 in	\$21.00
94458.....	3/4 in - 10 x 15 in	\$29.00
94459.....	3/4 in - 10 in x 21 in.....	\$37.00
.....	7/8 in - 9 in x 19 in.....	CONSULT

*Item obsolete or discontinued. When remaining stock is depleted, published prices are withdrawn and the item is subject to a special order quote.

XX Call for details.

Individual Cardinal Scale Parts

Truck Scale Parts (Cont.)

RICE LAKE PN	DESCRIPTION	SUGGESTED LIST
CM705	Equiv. Cardinal no. n/a Size: 1 in x 1 in x 1 1/2 in long Bearing	\$41.00
CM706	Equiv. Cardinal no. n/a Size: 1 in x 1 in x 1 3/4 in long Bearing	\$41.00
CM701	Equiv. Cardinal no. 1412-B001-9 Size: 1 in x 1 in x 2 in long Bearing	\$42.00
CM707	Equiv. Cardinal no. 1412-B001-19 Size: 1 in x 1 in x 4 in long Bearing	\$53.00
CM708	Equiv. Cardinal no. 1412-B001-13 Size: 1 in x 1 in x 5 in long Bearing	\$55.00
CM702	Equiv. Cardinal no. 1412-B001-3 Size: 1 in x 1 in x 6 in long Bearing	\$57.00
CM709	Equiv. Cardinal no. n/a Size: 1 in x 1 in x 7 in long Bearing	\$61.00
CM747	Equiv. Cardinal no. 1412-B001-5 Size: 1 in x 1 in x 8 in long Bearing	\$73.00
CM731	Equiv. Cardinal no. 1412-B001-7 Size: 1 in x 1 in x 10 in long Bearing	\$99.00
15274	Equiv. Cardinal no. n/a Size: 5/16 in dia x 3/4 in Roll pin	\$1.00
15263	Equiv. Cardinal no. n/a Size: 1/4 in dia x 3/4 in Roll pin	\$1.10
15285	Equiv. Cardinal no. Na Size: 3/8 in dia x 1 in Roll pin	\$1.00

HOLE SIZE ON ALL BEARINGS
5/16 in DIAMETER

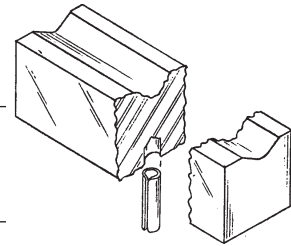

PIN SOLD SEPARATELY
BELOW



CARDINAL®

Individual Cardinal Scale Parts

Truck Scale Parts (Cont.)

CARDINAL®

RICE LAKE PN	DESCRIPTION	SUGGESTED LIST
CM710P	Equiv. Cardinal no. 1400-B001-13 Size: 1/2 in x 1 1/8 in x 1 1/2 in long Pivot:	\$31.00
109639	0.484 in x 1 in x 1 1/2 in	\$31.00
CM711P	Equiv. Cardinal no. n/a Size: 1/2 in x 1 1/8 in x 1 3/4 in long Pivot:	\$32.00
CM703P	Equiv. Cardinal no. 1400-B001-9 Size: 1/2 in x 1 1/8 in x 2 in long Pivot:	\$33.00
109640	0.484 in x 1 in x 2 in	\$33.00
CM712P	Equiv. Cardinal no. 1400-B001-5 Size: 1/2 in x 1 1/8 in x 3 7/8 in long Pivot:	\$40.00
109641	0.484 in x 1 in x 3 7/8 in	\$40.00
CM713P	Equiv. Cardinal no. 1400-B001-25 Size: 1/2 in x 1 1/8 in x 5 in long Pivot:	\$48.00
109642	0.484 in x 1 in x 5 in	\$48.00
CM704P	Equiv. Cardinal no. 1400-B001-19 Size: 1/2 in x 1 1/8 in x 6 in long Pivot:	\$50.00
109643	0.484 in x 1 in x 6 in	\$50.00
*CM714P	Equiv. Cardinal no. n/a Size: 1/2 in x 1 1/8 in x 7 in long Pivot:	\$63.00
CM748P	Equiv. Cardinal no. 1400-B001-21 Size: 1/2 in x 1 1/8 in x 8 in long Pivot:	\$74.00
109644	0.484 in x 1 in x 8 in	\$74.00
CM730P	Equiv. Cardinal no. 1400-B001-29 Size: 1/2 in x 1 1/8 in x 10 in long Pivot:	\$82.00
CM759	Equiv. Cardinal no. 0119-B125-52 Size: 1 3/4 in x 4 in x 15 in long Shackle	\$117.00

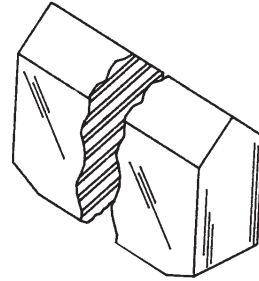

**ALL PIVOTS ARE
0.495 in W x 1.125 in H**
When ordering, measure
height and thickness. This
may vary. CONSULT 3.00 net
charge each for grinding
to size.

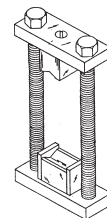





*Item obsolete or discontinued. When remaining stock is depleted, published prices are withdrawn and the item is subject to a special order quote.

XX Call for details.

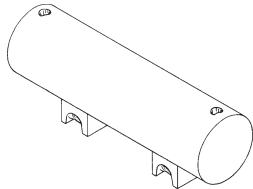
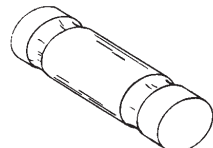
Individual Cardinal Scale Parts

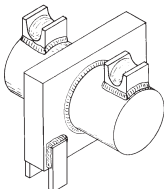
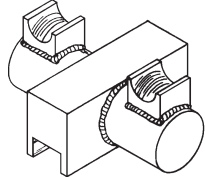
Truck Scale Parts (Cont.)

RICE LAKE PN	DESCRIPTION	SUGGESTED LIST	
CM738	Equiv. Cardinal no. 0119-B025, 47SRF Size: 1 3/4 in dia x 8 1/4 in long Use with CM740 or CM741 Trunnion (link pin)	\$102.00	
CM717	Equiv. Cardinal no. 0119-B019, 17SRF Size: 2 in dia x 9 1/4 in long Use with CM716, CM771, or CM749 Trunnion (link pin)	\$115.00	
CM766	Equiv. Cardinal no. 27SR and 0119-B028 Size: 1 1/4 in dia x 6 3/8 in long Use with CM788 and CM768L Trunnion (link pin)	\$96.00	
89099	Equiv. Cardinal no. 0103-B120-08 Size: 2 1/2 in dia x 11 1/4 in Trunnion old style; model EPR	\$141.00	
89223	Equiv. Cardinal no. 0112-B242-08 Size: 6 in x 4 1/2 in x 27 3/4 in Trunnion; model LPL	\$234.00	
CM740	Equiv. Cardinal no. 0119-B026 Size: 5 3/4 in x 3/8 in x 4 1/2 in Welded on tabs to hold bearing Use bearing CM708 and link CM739L Type A	\$203.00	
CM741	Equiv. Cardinal no. 44SRF Size: 5 3/4 in x 2 5/8 in x 4 1/2 in Machined slot to hold bearing Use bearing CM708 and link CM775L Type B	\$203.00	
CM716	Equiv. Cardinal no. 0119-B018, 14SRF Size: 5 3/4 in x 4 in x 5 1/2 in Welded on tabs to hold bearing Use bearing CM702 and link CM715L Type A	\$239.00	
CM771	Equiv. Cardinal no. 14SRF Size: 5 3/4 in x 3 1/4 in x 5 1/2 in Machined slot to hold bearing Use bearing CM702 and link CM772L Type A	\$239.00	
CM749	Equiv. Cardinal no. 0119-B022, 0119-B197 Size: 5 3/4 in x 4 in x 7 1/2 in Welded on tab to hold bearing Use bearing CM747 and link CM784L Type A	\$244.00	
10029	Equiv. Cardinal no. 24SR and 0119-C019 Size: 4 1/4 in x 2 in x 3 3/8 in Use with CM766 and CM768L Type B (casting)	\$203.00	

CARDINAL®

Individual Cardinal Scale Parts

Truck Scale Parts (Cont.)

CARDINAL®

RICE LAKE PN	DESCRIPTION	SUGGESTED LIST
CM739L	Equiv. Cardinal no. 0119-C014 Size: 5/8 in x 4 1/8 in x 12 3/8 in Inside length: 8 3/4 in Use with saddle block CM740	\$113.00
CM775L	Equiv. Cardinal no. 46SRF Size: 5/8 in x 4 1/4 in x 11 3/8 in Inside length: 7 3/4 in Use with saddle block CM741	\$113.00
CM715L	Equiv. Cardinal no. 0119-B007,16SRF Size: 5/8 in x 4 7/8 in x 13 3/8 in Inside length: 9 1/2 in Use with saddle block CM716	\$117.00
CM772L	Equiv. Cardinal no. n/a Size: 5/8 in x 5 in x 12 5/16 in Inside length: 8 3/4 in Use with saddle block CM771	\$117.00
CM784L	Equiv. Cardinal no. 0119-C007, 0119-B195 Size: 5/8 in x 6 in x 14 1/4 in Inside length: 9 3/8 in Use with saddle block CM749	\$123.00
CM768	Equiv. Cardinal no. 26SR and 0119-C017 Size: 1/2 in x 3 5/8 in x 10 1/4 in Inside length: 7 1/4 in Use with saddle block CM788	\$140.00
89289	Equiv. Cardinal no. 0112-C246-OA Size: 5/8 in x 5 in x 14 1/2 in Inside length: 10 3/4 in Link models LP	\$141.00
156479	Equiv. Cardinal no. 102-C019A Size: 5/8 in x 5 in x 10 in Inside length: 6 in Link model EPR, 35k load cells	\$117.00
89095	Equiv. Cardinal no. 0103-C121-OA Size: 3/4 in x 6 in x 12 in Inside length: 7 in Link, model EPR, 50K CELLS	\$125.00
156480	Equiv. Cardinal no. 0105-C071-OA Size: 1 in x 6 in x 12 in Inside length: 7 in Link model EPR, 75k load cells	\$132.00

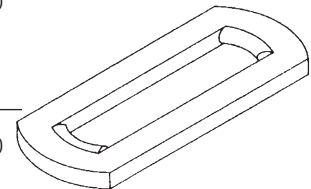
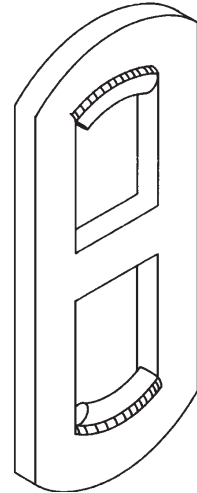

Individual Cardinal Scale Parts

Truck Scale Stands and Chairs

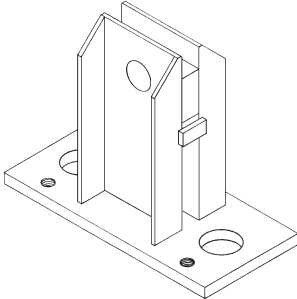
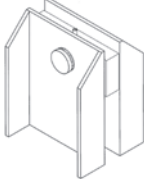
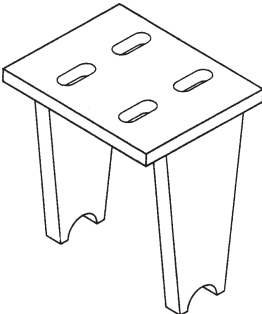
RICE LAKE PN	DESCRIPTION	SUGGESTED LIST	
CM737	Equiv. Cardinal no. 0119-C016 Base: 6 in x 13 in x 10 1/2 in Height: 9 3/8 in to bearing For 5 in bearing, CM708 Used in 20- and 25-ton, two-section 40-Ton, 3 section scale scales; stand	\$343.00	
CM765	Equiv. Cardinal no. 0119-C009 Base: 8 in x 14 in Height: 12 1/2 in For 6 in bearing, CM702 Used in 30-, 50- and 60-ton scales; stand	\$368.00	
CM779	Equiv. Cardinal no. 0119-C010 Base: 8 in x 14 in Height: 12 1/2 in For 8 in bearing, CM747 Used in 80-ton scale; stand	\$399.00	
66219	Equiv. Cardinal no. 0119-C040 Size: 5 in x 8 in x 6 in For PV scales	\$274.00	
CM785	Equiv. Cardinal no. 0119-C068 Base: 6 in x 14 in Height, total: 23 in Torque tube stand	\$361.00	
CM767	Equiv. Cardinal no. 0119-C008 Base: 8 in x 10 in Height: 12 1/4 in Use with CM717 trunnion pin Used in 30-ton, 2 section, 50-, 60- And 80-ton, 2, 4 and 5 section scales Chair	\$368.00	



*Item obsolete or discontinued. When remaining stock is depleted, published prices are withdrawn and the item is subject to a special order quote.

XX Call for details.

Individual Cardinal Scale Parts

Model EPR Truck Scale

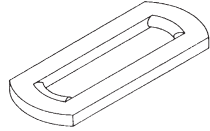
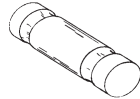
CARDINAL®

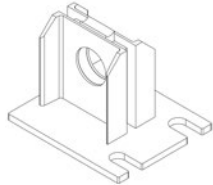
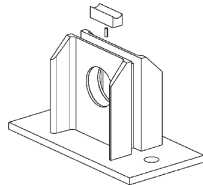
RICE LAKE PN	DESCRIPTION	SUGGESTED LIST	
156479	Equiv. Cardinal no. 102-C019A Size: 5/8 in x 5 in x 10 in Inside length: 6 in Link model EPR 35k load cells	CONSULT	
89095	Equiv. Cardinal no. 0103-C121-OA Size: 3/4 in x 6 in x 12 in Link 7 in id 50k load cell	\$125.00	
156480	Equiv. Cardinal no. 0105-C071-OA Size: 1 in x 6 in x 12 in Inside length: 7 in Link model epr 75k load cells	\$132.00	
89099	Equiv. Cardinal no. 0103-B120-08 Size: 2 1/2 in dia x 11 1/4 in Trunnion	\$141.00	
89438	Equiv. Cardinal no. 2993-B036-08 Size: 1 1/4 in dia x 3 5/8 in Rocker pivot	\$76.00	
89466	Equiv. Cardinal no. 0103-C127-OA Size: 11 in x 13 in x 9 in high Stand side access With bearing insert PN 89728	\$393.00	
111251	Equiv. Cardinal 0103-C204-OA Size: 11 in x 13 in x 9 in high Stand, top access With bearing insert PN 89728	\$393.00	
89728	Equiv. Cardinal no. 2993-B021-08 bearing 1 in x 1 in x 3 in	\$72.00	
91765	Equiv. Cardinal no DB50000S Load cell 50k	\$1,195.00	

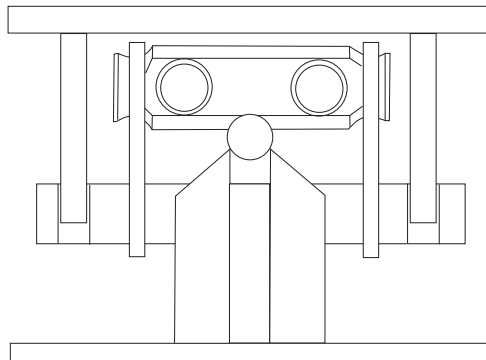

Cardinal Diagram

NOTE: Diagram not to scale

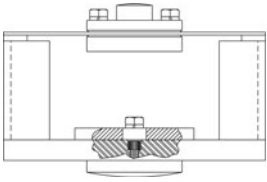
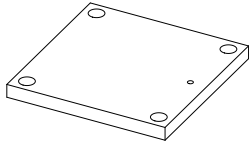
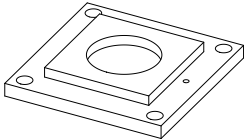
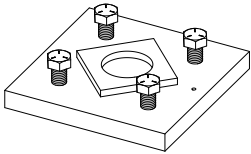
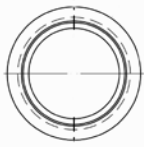

Individual Cardinal Scale Parts

Electronic Truck Scale

RICE LAKE PN	DESCRIPTION	SUGGESTED LIST	
67297	Equiv. Cardinal no. 100-1465 Size: 6 in W x 7 5/16 in H x 11 in L Load cell box	\$987.00	
89102	Equiv. Cardinal no. Size: 1/2 in x 6 in x 6 in Top plate, no retainer	\$86.00	
89103	Equiv. Cardinal no. 0146-B018-OA Size 1/2 in x 6 in x 6 in Top plate For truck scales with SCA 50 k Load cells	\$167.00	
89137	Equiv. Cardinal no. Size: 1 in x 9 in x 9 in Base plate with leveling lugs For truck scales with SCA 50 k Load cells	\$193.00	
69431	Equiv. Cardinal no. Size: 2 1/4 in dia x 13/16 in tall Load cups with o-ring For truck scales with SCA 50 k Load cells	\$63.00	
67497	Equiv. Cardinal no. 3501-B034 Size: 3/4 in thick x 4 in dia Button at top of this page For bottom of PN 67297	\$120.00	

CARDINAL®

Notes:

CARDINAL KITS

CARDINAL®

Cardinal Kit Price Index By Rice Lake PN

RL PN	SUGGESTED LIST	PAGE #
CM-751-K	\$1,171.00	236
CM-752-K	\$1,235.00	236
CM-753-K	\$1,443.00	237
CM-754-K	\$1,962.00	237
CM-755-K	\$2,277.00	238
CM-756-K	\$3,036.00	240
CM-757-K	\$3,574.00	242
CM-758-K	\$4,365.00	242

RL PN	SUGGESTED LIST	PAGE #
CM-759-K	\$3,480.00	240
CM-760-K	\$2,783.00	238
CM-761-K	\$2,505.00	237
CM-762-K	\$1,741.00	237
CM-763-K	\$1,670.00	236
CM-764-K	\$1,954.00	236
CM-765-K	\$1,265.00	243
CM-766-K	\$1,392.00	243

RL PN	SUGGESTED LIST	PAGE #
CM-767-K	\$3,790.00	241
CM-768-K	\$4,428.00	241
CM-769-K	\$3,259.00	239
CM-770-K	\$3,947.00	239
CM-771-K	\$3,947.00	239

Cardinal Kit Reference By Capacity

CAPACITY	RICE LAKE PN	PAGE #
Pivot and Bearing Kits		
15 TON	CM-751-K	236
20 AND 25 TON	CM-752-K	236
30 TON	CM-753-K	237
40 TON	CM-754-K	237
50 TON	CM-755-K	238
50 AND 60 TON	CM-756-K	240
80 TON	CM-757-K	242

CAPACITY	RICE LAKE PN	PAGE #
Suspension Kits		
15 TON	CM-764-K	236
20 AND 25 TON	CM-763-K	236
30 TON	CM-762-K	237
40 TON	CM-761-K	237
50 TON	CM-760-K	238
50 AND 60 TON	CM-759-K	240
80 TON	CM-758-K	242

CAPACITY	RICE LAKE PN	PAGE #
Dormant Scales		
6,500 LB	CM-765-K	243
12,000 LB	CM-766-K	243
50 AND 60 TON	CM-767-K	241
50 AND 60 TON	CM-768-K	241
50 TON	CM-769-K	239
50 TON	CM-770-K	239
50 TON	CM-771-K	239

Cardinal Truck Scale Profile

Typical Height Dimensions

SR MECHANICAL PIT TYPE

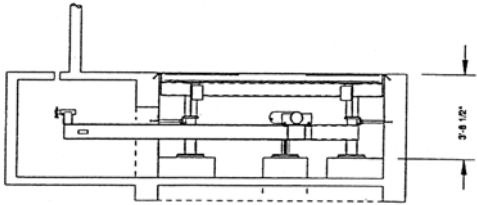

SRICE LAKE MECHANICAL PIT TYPE WITH SINGLE LOAD CELL

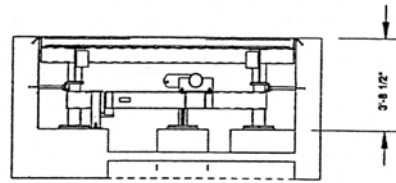

PR MECHANICAL PORTABLE TYPE

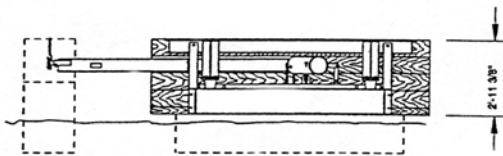

PRICE LAKE MECHANICAL PORTABLE TYPE WITH SINGLE LOAD CELL

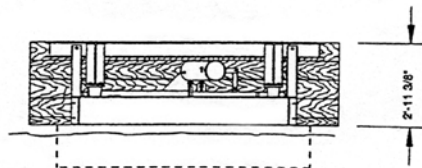

LP-2 MECHANICAL LOW PROFILE WITH STEEL DECK

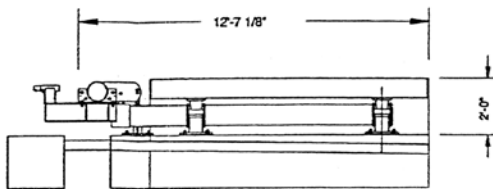

LP-2C MECHANICAL LOW PROFILE WITH CONCRETE DECK

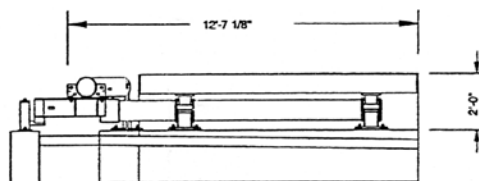

CARDINAL®

Cardinal Truck Scale Profile

Typical Height Dimensions

CARDINAL®

LPL-3 MECHANICAL LOW PROFILE, FLAT TOP, SINGLE LOAD CELL

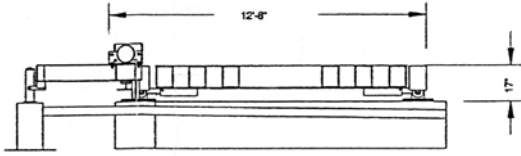

EPR ELECTRONIC LOW PROFILE PORTABLE

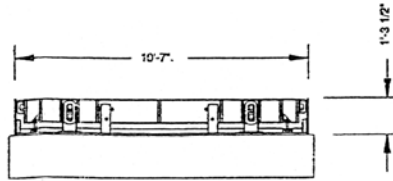

SRC ELECTRONIC PIT TYPE

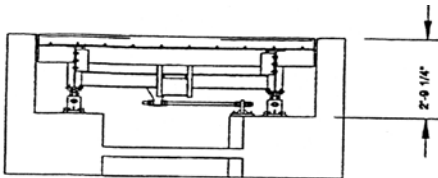

PRC-H ELECTRONIC LOW PROFILE WITH HIPS

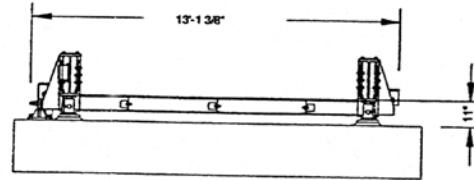

PRC-1 ELECTRONIC LOW PROFILE, FLAT TOP, STEEL DECK

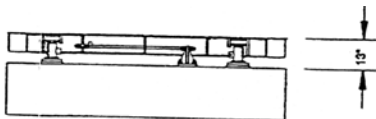

PRC-1-C ELECTRONIC LOW PROFILE FLAT TOP CONCRETE DECK

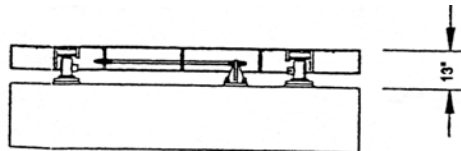

Cardinal Motor Truck Scale

REFERENCE SHEET

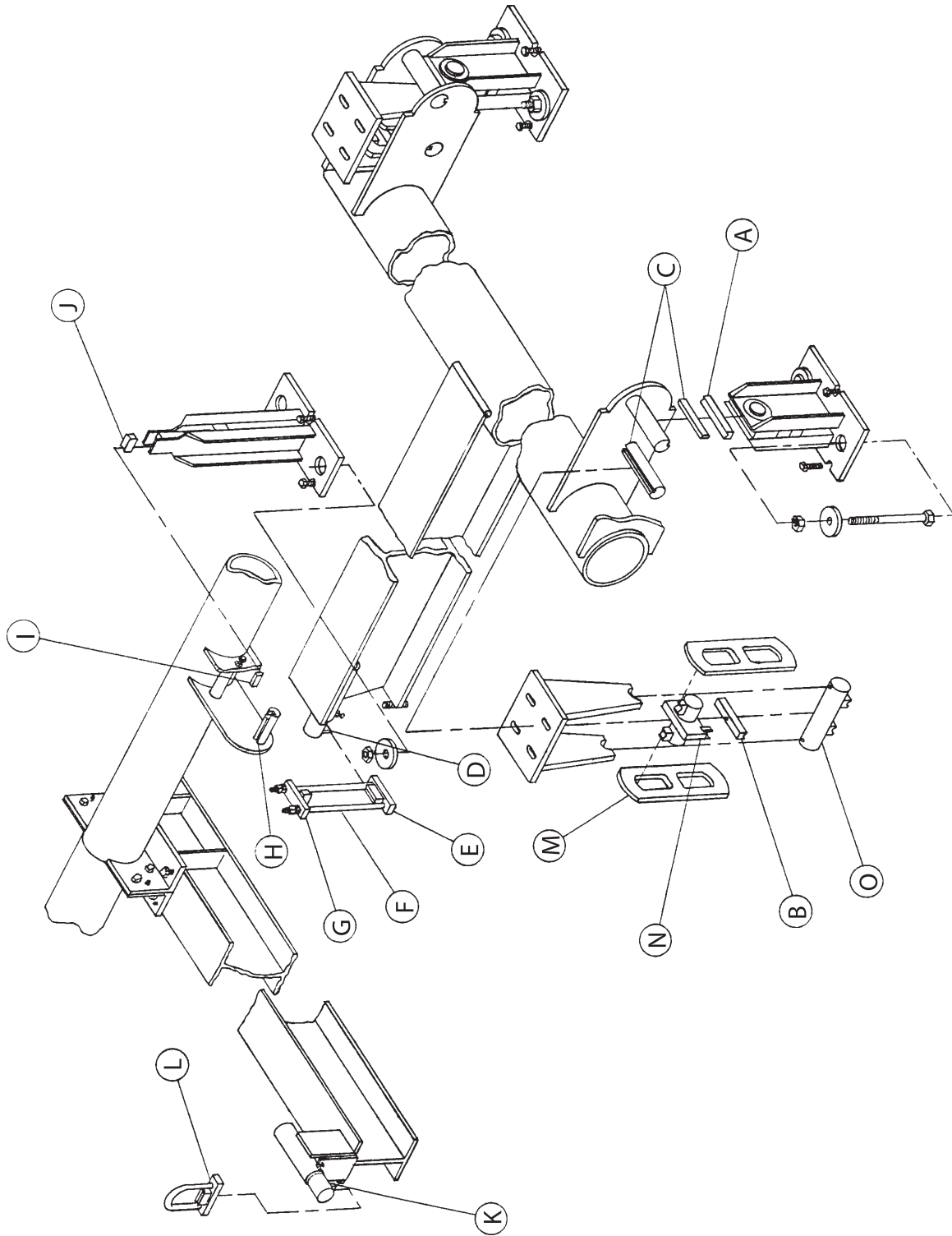

MEASURE LOAD OR FULCRUM PIVOT HEIGHT AND WIDTH BEFORE ORDERING

CARDINAL®

Truck Scale

CARDINAL®

Kit No. CM-751-K

Pivot and Bearing Kit For Model 1522SR, 2-Section, 15-Ton, 22-Ft. Truck Scale* SR, SRice Lake, PR and PRice Lake

REF #	QTY	RICE LAKE PN	EQUIV. CARDINAL #	DESCRIPTION
A	4	CM707	1412-B001-19	Bearing, fulcrum
B	4	CM707	1412-B001-19	Bearing, load
C	8	CM712P	1400-B001-5	Pivot, load and fulcrum
D	2	CM710P	1400-B001-13	Pivot, tip
E, F, G	2	CM758	0119-B125-51	Shackle assembly
H	2	CM712P	1400-B001-5	Pivot, load
I	2	CM703P	1400-B001-9	Pivot, fulcrum
J	2	CM701	1412-B001-9	Bearing, fulcrum
K	1	CM710P	1400-B001-13	Pivot, tip
L	1	CM718	0119-B103-2	Loop, tip

ALL PIVOTS ARE
0.495 in W x 1.125 in H
 When ordering, measure height and thickness. This may vary. **CONSULT 3.00 net charge each for grinding to size.**

\$1,171.00 Suggested list/32 lb shipping weight

Kit No. CM-764-K

Suspension Kit For CM-751-K

REF #	QTY	RICE LAKE PN	EQUIV. CARDINAL #	DESCRIPTION
M	8	CM768	0119-C017 (26SR)	Link
N	4	CM788	0119-C019 (24SR)	Saddle block
O	4	CM766	0119-B028	Trunnion

\$1,954.00 Suggested list/47 lb shipping weight

Kit No. CM-752-K

Pivot and Bearing Kit For Models 2024SR, 2010 APL Axle Load 2034SR, 2524SR, 2-Section, 20-Ton, 24- and 34-Ft. Truck Scale, 2-Section, 25-Ton, 24-Ft. Truck Scale* SR, SRice Lake, PR and PRice Lake

REF #	QTY	RICE LAKE PN	EQUIV. CARDINAL #	DESCRIPTION
A	4	CM708	1412-B001-13	Bearing, fulcrum
B	4	CM708	1412-B001-13	Bearing, load
C	8	CM713P	1400-B001-25	Pivot, lead and fulcrum
D	2	CM710P	1400-B001-13	Pivot, tip
E, F, G	2	CM759	0119-b125-52	Shackle assembly
H	2	CM712P	1400-B001-5	Pivot, load
I	2	CM703P	1400-B001-9	Pivot, fulcrum
J	2	CM701	1412-B001-9	Bearing, fulcrum
K	1	CM710P	1400-B001-13	Pivot, tip
L	1	CM718	0119-b103-2	Loop, tip

ALL PIVOTS ARE
0.495 in W x 1.125 in H
 When ordering, measure height and thickness. This may vary. **CONSULT 3.00 net charge each for grinding to size.**

\$1,235.00 Suggested list/36 lb shipping weight

Kit No. CM-763-K

Suspension Kit For CM-752-K

REF #	QTY	RICE LAKE PN	EQUIV. CARDINAL #	DESCRIPTION
M	8	CM739L	0119-C014	Link
N	4	CM740	0119-B026	Saddle block
O	4	CM738	0119-B025, 47SRF	Trunnion

\$1,670.00 Suggested list/100 lb shipping weight

* Measure load or fulcrum pivot height and width before ordering.

Truck Scale

Kit No. CM-753-K

Pivot and Bearing Kit For Models 3024SR, 3034SR, 2-Section, 30-Ton, 24- and 34-Ft. Truck Scale SR, SRice Lake, PR and PRice Lake

REF #	QTY	RICE LAKE PN	EQUIV. CARDINAL #	DESCRIPTION
A	4	CM702	1412-B001-3	Bearing, fulcrum
B	4	CM702	1412-B001-3	Bearing, load
C	8	CM704P	1400-B001-19	Pivot, load and fulcrum
D	2	CM703P	1400-B001-9	Pivot, tip
E	2	CM720	0119-B127-52	Bearing, lower shackle
F	4	CM721	0119-B127-52	Bolt, shackle
G	2	CM719	0119-B127-52	Bearing, upper shackle
H	2	CM712P	1400-B001-5	Pivot, load
I	2	CM703P	1400-B001-9	Pivot, fulcrum
J	2	CM701	1412-B001-9	Bearing, fulcrum
K	1	CM703P	1400-B001-9	Pivot, tip
L	1	CM756	0119-b103-1	Loop, tip

ALL PIVOTS ARE
0.495 in W x 1.125 in H
 When ordering, measure height and thickness. This may vary. **CONSULT3.00 net charge each for grinding to size.**

\$1,443.00 Suggested list/40 lb shipping weight

Kit No. CM-762-K

Suspension Kit For CM-753-K

REF #	QTY	RICE LAKE PN	EQUIV. CARDINAL #	DESCRIPTION
M	8	CM715L	0119-B007 (16SRF)	Link
N	4	CM716	0119-B018 (14SRF)	Saddle block
O	4	CM717	0119-B019 (17SRF)	Trunnion

\$1,741.00 Suggested list/140 lb shipping weight

Kit No. CM-754-K

Pivot and Bearing Kit For Model 4040SR, 3-Section, 40-Ton, 40-Ft. Truck Scale* SR, Rice Lake, PR and Rice Lake

REF #	QTY	RICE LAKE PN	EQUIV. CARDINAL #	DESCRIPTION
A	6	CM708	1412-B001-13	Bearing, fulcrum
B	6	CM708	1412-B001-13	Bearing, load
C	12	CM713P	1400-B001-25	Pivot, load and fulcrum
D	3	CM710P	1400-B001-13	Pivot, tip
E, F, G	3	CM760	0119-B125-53	Shackle assembly
H	3	CM712P	1400-B001-5	Pivot, load
I	3	CM703P	1400-B001-9	Pivot, fulcrum
J	3	CM701	1412-B001-9	Bearing, fulcrum
K	1	CM703P	1400-B001-9	Pivot, tip
L	1	CM756	0119-B103-1	Loop, tip

ALL PIVOTS ARE
0.495 in W x 1.125 in H
 When ordering, measure height and thickness. This may vary. **CONSULT3.00 net charge each for grinding to size.**

\$1,962.00 Suggested list/54 lb shipping weight

Kit No. CM-761-K

Suspension Kit For CM-754-K

REF#	QTY	RICE LAKE PN	EQUIV. CARDINAL #	DESCRIPTION
M	12	CM739L	0119-C014	Link
N	6	CM740	0119-B026	Saddle block
O	6	CM738	0119-B025 (47SRF)	Trunnion

\$2,505.00 Suggested list/133 lb shipping weight

* Measure load or fulcrum pivot height and width before ordering.

Truck Scale

Kit No. CM-755-K

Pivot and Bearing Kit For Model 5045SR, 3535 SR, 3540 SR, 3-Section,
50-Ton, 45-Ft. Truck Scale*, SR, SRice Lake, PR and PRice Lake

REF #	QTY	RICE LAKE PN	EQUIV. CARDINAL #	DESCRIPTION
A	6	CM702	1412-B001-3	Bearing, fulcrum
B	6	CM702	1412-B001-3	Bearing, load
C	12	CM704P	1400-B001-19	Pivot, load and fulcrum
D	3	CM703P	1400-B001-9	Pivot, tip
E	3	CM720	0119-B127-52	Bearing, lower shackle
F	6	CM721	0119-B127-52	Bolts, shackle
G	3	CM719	0119-B127-52	Bearing, upper shackle
H	3	CM712P	1400-B001-5	Pivot, load
I	3	CM703P	1400-B001-9	Pivot, fulcrum
J	3	CM701	1412-B001-9	Bearing, fulcrum
K	1	CM703P	1400-B001-9	Pivot, tip
L	1	CM756	0119-B103-1	Loop, tip

ALL PIVOTS ARE
0.495 in W x 1.125 in H
When ordering, measure
height and thickness. This
may vary. **CONSULT**3.00 net
charge each for grinding to
size.

\$2,277.00 Suggested list/60 lb shipping weight

Kit No. CM-760-K

Suspension Kit For CM-755-K

REF #	QTY	RICE LAKE PN	EQUIV. CARDINAL #	DESCRIPTION
M	12	CM715L	0119-B007(16SRF)	Link
N	6	CM716	0119-B018(14SRF)	Saddle block
O	6	CM717	0119-B019(17SRF)	Trunnion

\$2,783.00 Suggested list/200 lb shipping weight

* Measure load or fulcrum pivot height and width before ordering.

Truck Scale

Kit No. CM-769-K

Pivot and Bearing Kit, 5-Section, 50- and 60-Ton, Truck Scale With 5 in Load Fulcrum

REF #	QTY	RICE LAKE PN	EQUIV. CARDINAL #	DESCRIPTION
A	10	CM708	1412-B001-13	Bearing, fulcrum
B	10	CM708	1412-B001-15	Bearing, load
C	20	CM713P	1400-B001-25	Pivot, load and fulcrum
D	5	CM710P	1400-B001-13	Pivot, tip
E,F,G	5	CM759	0119-B125-52	Shackle assembly
H	5	CM712P	1400-B001-5	Pivot, load
I	5	CM703P	1400-B001-9	Pivot, fulcrum
J	5	CM701	1412-B001-9	Bearing, fulcrum
K	1	CM710P	1400-B001-13	Pivot, tip
L	1	CM718	0119-B103-2	Loop, tip

ALL PIVOTS ARE
0.495 in W x 1.125 in H
When ordering, measure height and thickness. This may vary. CONSULT 3.00 net charge each for grinding to size.

\$3,259.00 Suggested list/76 lb shipping weight

Kit No. CM-770-K

Suspension Kit For CM-769-K TYPE A

REF #	QTY	RICE LAKE PN	EQUIV. CARDINAL #	DESCRIPTION
M	20	CM739L	0119-C014	Link
N	10	CM740	0119-B026	Saddle block
O	10	CM738	0119-B025, 47SRF	Trunnion

\$3,947.00 Suggested list/243 lb shipping weight

Kit No. CM-771-K

Suspension Kit For CM-769-K TYPE B

REF #	QTY	RICE LAKE PN	EQUIV. CARDINAL #	DESCRIPTION
M	20	CM775L	46SRF	Link
N	10	CM741	44SRF	Saddle block
O	10	CM738	0119-B025, 47SRF	Trunnion

\$3,947.00 Suggested list/234 lb shipping weight

** Measure load or fulcrum pivot height and width before ordering.*

Truck Scale

Kit No. CM-756-K

Pivot and Bearing Kit For Models SR, SRice Lake, PR and PRice Lake, 5050SR, 5060SR, 5070SR, 6050SR, 6060SR, 6070SR

4-Section, 50- and 60-Ton, 50-, 60- and 70-Ft. Motor Truck Scale*

REF #	QTY	RICE LAKE PN	EQUIV. CARDINAL #	DESCRIPTION
A	8	CM702	1412-B001-3	Bearing, fulcrum
B	8	CM702	1412-B001-3	Bearing, load
C	16	CM704P	1400-B001-19	Pivot, load and fulcrum
D	4	CM703P	1400-B001-9	Pivot, tip
E	4	CM720	0119-B127-53	Bearing, lower shackle
F	8	CM721	0119-B127-53	Bolt, shackle
G	4	CM719	0119-B127-53	Bearing, upper shackle
H	4	CM712P	1400-B001-5	Pivot, load
I	4	CM703P	1400-B001-9	Pivot, fulcrum
J	4	CM701	1412-B001-9	Bearing, fulcrum
K	1	CM703P	1400-B001-9	Pivot, tip
L	1	CM756	0119-B103-1	Loop, tip

**ALL PIVOTS ARE
0.495 in W x 1.125 in H**
When ordering, measure
height and thickness. This
may vary. **CONSULT 3.00 net**
charge each for grinding to
size.

\$3,036.00 Suggested list/77 lb shipping weight

Kit No. CM-759-K

Suspension Kit For CM-756-K

REF #	QTY	RICE LAKE PN	EQUIV. CARDINAL #	DESCRIPTION
M	16	CM715L	0119-B007(16SRF)	Link
N	8	CM716	0119-B018(14SRF)	Saddle block
O	8	CM717	0119-B019(17SRF)	Trunnion

\$3,480.00 Suggested list/280 lb shipping weight

* Measure load or fulcrum pivot height and width before ordering.

Truck Scale

Kit No. CM-767-K

Pivot and Bearing Kit For Models 5080SR, 6080SR, SR, SRice Lake, PR and PRice Lake
5-Section, 50- and 60-Ton, 80-Ft. Motor Truck Scale

REF #	QTY	RICE LAKE PN	EQUIV. CARDINAL #	DESCRIPTION
A	10	CM702	1412-B001-3	Bearing, fulcrum
B	10	CM702	1412-B001-3	Bearing, load
C	20	CM704P	1400-B001-19	Pivot, load and fulcrum
D	5	CM703P	1400-B001-9	Pivot, tip main lever
E	5	CM720	0119-B127-53	Bearing, lower shackle
F	10	CM721	0119-B127-53	Bolt, shackle
G	5	CM719	0119-B127-53	Bearing, upper shackle
H	5	CM712P	1400-B001-5	Pivot, load
I	5	CM703P	1400-B001-9	Pivot, fulcrum
J	5	CM701	1412-B001-9	Bearing, fulcrum
K	1	CM703P	1400-B001-9	Pivot, tip
L	1	CM756	0119-B103-1	Loop, tip

ALL PIVOTS ARE
0.495 in W x 1.125 in H
When ordering, measure height and thickness. This may vary. CONSULT 3.00 net charge each for grinding to size.

\$3,790.00 Suggested list/93 lb shipping weight

Kit No. CM-768-K

Suspension Kit For CM-767-K

REF #	QTY	RICE LAKE PN	EQUIV. CARDINAL #	DESCRIPTION
M	20	CM715L	0119-B007	Link
N	10	CM716	0119-B018	Saddle block
O	10	CM717	0119-B019	Trunnion

\$4,428.00 Suggested list/337 lb shipping weight

* Measure load or fulcrum pivot height and width before ordering.

Truck Scale

Kit No. CM-757-K

Pivot and Bearing Kit For Models SR, SRice Lake, PR and PRice Lake, 8050SR, 8060SR, 8070SR, 4-Section, 80-Ton, 50-, 60- and 70- Ft. Motor Truck Scale*

REF #	QTY	RICE LAKE PN	EQUIV. CARDINAL #	DESCRIPTION
A	8	CM747	1412-B001-5	Bearing, fulcrum
B	8	CM747	1412-B001-5	Bearing, load
C	16	CM748P	1400-B001-21	Pivot, load and fulcrum
D	4	CM703P	1400-B001-9	Pivot, tip
E	4	CM720	0119-B127-52	Bearing, lower shackle
F	8	CM721	0119-B127-52	Bolt, shackle
G	4	CM719	0119-B127-52	Bearing, upper
H	4	CM712P	1400-B001-5	Pivot, load
I	4	CM703P	1400-B001-9	Pivot, fulcrum
J	4	CM701	1412-B001-9	Bearing, fulcrum
K	1	CM703P	1400-B001-9	Pivot, tip
L	1	CM756	0119-B103-1	Loop, tip

**ALL PIVOTS ARE
0.495 in W x 1.125 in H**
When ordering, measure
height and thickness. This
may vary. CONSULT 3.00 net
charge each for grinding to
size.

\$3,574.00 Suggested list/86 lb shipping weight

Kit No. CM-758-K

Suspension Kit For CM-757-K

REF NO.	QTY	RICE LAKE PN	EQUIV. CARDINAL #	DESCRIPTION
M	16	CM784L	0119-C007	Link
N	8	CM749	0119-B022	Saddle block
O	8	CM717	0119-B019(17SRF)	Trunnion

\$4,365.00 Suggested list/327 lb shipping weight

* Measure load or fulcrum pivot height and width before ordering.

Dormant Scale

Kit No. CM-765-K

Pivot and Bearing Kit For Models XD4638L TO XD9672L, XD, XTD and XDL, 6,500 lb Capacity Dormant Scale

QTY	RICE LAKE PN	DESCRIPTION
-----	--------------	-------------

4.....	CM743P	Pivot, main lever fulcrum, 3/8 in x 3/4 in x 1 7/8 in
4.....	CM745P	Pivot, main lever load, 3/8 in x 3/4 in x 2 3/4 in
4.....	CM751	Bearing, main lever fulcrum, 1 1/4 in dia x 1 in
4.....	CM757	Bearing, main lever load, 15/16 in x 1 3/8 in x 2 1/2 in
2.....	CM744P	Pivot, main lever tip, 3/8 in x 3/4 in x 1 in
2.....	CM752.....	Bearing, main lever tip, 15/16 in x 15/16 in x 1 in
2.....	CM742P	Pivot, transverse lever fulcrum, 3/8 in x 3/4 in x 1 1/4 in
2.....	CM750.....	Bearing, transverse lever fulcrum, 1 in dia x 9/16 in
2.....	CM744P	Pivot, transverse lever load, 3/8 in x 3/4 in x 1 in
2.....	CM754.....	Bearing, transverse lever, 7/8 in x 7/8 in x 11/16 in
2.....	CM753.....	Bearing, transverse lever fulcrum, 3/4 in x 3/4 in x 3/4 in
1.....	CM746P	Pivot, transverse lever fulcrum, 0.360 Sq. x 3 in

\$1,265.00 Suggested list/8 lb shipping weight

Kit No. CM-766-K

Pivot and Bearing Kit, 12,000 lb Capacity Dormant Scale, Models SCD and SCDL

QTY	RICE LAKE PN	DESCRIPTION
-----	--------------	-------------

4.....	CM789P	Pivot, main lever fulcrum, 3/8 in x 3/4 in x 2 3/8 in
4.....	CM745P	Pivot, main lever load, 3/8 in x 3/4 in x 2 3/4 in
4.....	CM787	Bearing, main lever fulcrum, 2 in dia x 1/38 in
4.....	CM757	Bearing, main lever load, 15/16 in x 1 3/8 in x 2 1/2 in
2.....	CM744P	Pivot, main lever tip, 3/8 in x 3/4 in x 1 in
2.....	CM752.....	Bearing, main lever tip, 15/16 in x 15/16 in x 1 in
2.....	CM742P	Pivot, transverse lever fulcrum, 3/8 in x 3/4 in x 1 1/4 in
2.....	CM750.....	Bearing, transverse lever fulcrum, 1 in dia x 9/16 in
2.....	CM744P	Pivot, transverse lever load, 3/8 in x 3/4 in x 1 in
2.....	CM754.....	Bearing, transverse lever fulcrum, 7/8 in x 7/8 in x 11/16 in
2.....	CM753.....	Bearing, transverse lever fulcrum, 3/4 in x 3/4 in x 3/4 in
1.....	CM746P	Pivot, transverse lever fulcrum, 0.360 Sq x 3 in

\$1,392.00 Suggested list/11 lb shipping weight

* Measure load or fulcrum pivot height and width before ordering.

