

# CLS-680

*Forklift Scale Display  
Firmware Version 1*

## Technical Manual



© Rice Lake Weighing Systems. All rights reserved.

Rice Lake Weighing Systems® is a registered trademark of  
Rice Lake Weighing Systems.

All other brand or product names within this publication are trademarks or  
registered trademarks of their respective companies.

All information contained within this publication is, to the best of our knowledge, complete and  
accurate at the time of publication. Rice Lake Weighing Systems reserves the right to make  
changes to the technology, features, specifications and design of the equipment without notice.

The most current version of this publication, software, firmware and all other product  
updates can be found on our website:

[www.ricelake.com](http://www.ricelake.com)

# Revision History

---

This section tracks and describes manual revisions for awareness of major updates.

Revision	Date	Description
E	February 17, 2023	Established revision history; added custom stream formatting content and some J-Box specific menu updates; firmware version 1.03
F	February 23, 2024	Updated replacement parts

*Table i. Revision Letter History*



*Technical training seminars are available through Rice Lake Weighing Systems. Course descriptions and dates can be viewed at [www.ricelake.com/training](http://www.ricelake.com/training) or obtained by calling 715-234-9171 and asking for the training department.*

# Contents

<b>1.0</b>	<b>Introduction</b>	<b>7</b>
1.1	Safety	7
1.2	FCC Compliance	8
1.3	Operating Modes	8
<b>2.0</b>	<b>Installation</b>	<b>9</b>
2.1	Unpacking	9
2.1.1	Product Dimensions	9
2.2	Mounting Instructions	10
2.2.1	RAM Mounting	10
2.3	External Cable Connections	11
2.3.1	Power Connector	11
2.3.2	Junction Box Connector	11
2.3.3	Serial Connector	12
2.4	Interior Access	12
2.4.1	Backplate Reattachment	12
2.5	Updating Firmware	12
2.6	CPU Board	13
2.7	DC Power Board	13
2.8	Replacement Parts	14
2.8.1	Replacement Parts List	15
2.9	Parts Kit Components	15
2.10	Torque Ratings	16
2.11	Sealing the Enclosure (Optional)	16
<b>3.0</b>	<b>Operation</b>	<b>17</b>
3.1	Power Button	17
3.2	Front Panel	17
3.3	LED Annunciators	18
3.4	General Navigation	18
3.4.1	Numeric Value Entry	18
3.4.2	Alphanumeric Entry	19
3.5	General Operation	19
3.5.1	Zero Scale	19
3.5.2	Print Ticket	19
3.5.3	Toggle Units	19
3.5.4	Toggle Gross/Net Mode	19
3.5.5	Acquire Tare	20
3.5.6	Remove Stored Tare Value	20
3.5.7	Preset Tare (Keyed Tare)	20
3.5.8	Display a Stored Tare	20
3.5.9	Clear a Stored Tare	20
3.5.10	View Audit Trail Counters	21
3.5.11	View Legally Relevant Version	21
3.5.12	Display Accumulator	21
3.5.13	Print Accumulator	21
3.5.14	Clear Accumulator	22
3.5.15	Enter New Unit ID	22



Rice Lake continually offers web-based video training on a growing selection of product-related topics at no cost. Visit [www.ricelake.com/webinars](http://www.ricelake.com/webinars)

3.5.16	View and Edit Time Value	22
3.5.17	View and Edit Date Value	23
3.5.18	WiFi and Bluetooth® MAC IDs	23
3.5.19	Default Configurable Parameters	23
<b>4.0</b>	<b>Configuration</b>	<b>24</b>
4.1	Setup Switch	24
4.1.1	Audit Switch	24
4.2	Main Menu	25
4.3	Audit Menu	25
4.4	Setup Menu	25
4.4.1	Setup – Configuration Menu	26
4.4.2	Setup – Format Menu	27
4.4.3	Setup – Calibration Menu	27
4.4.4	Setup – Communication Menu	28
4.4.5	Setup – Program Menu	29
4.4.6	Setup – Print Format Menu	31
4.4.7	Setup – Stream Format Menu	32
4.4.8	Setup – Default Menu	33
4.5	Accumulator Menu	33
4.6	Tare Menu	33
4.7	MAC ID Menu	34
4.8	J-Box Info Menu	34
<b>5.0</b>	<b>Calibration</b>	<b>35</b>
5.1	Calibration Preparation	35
5.1.1	Devices used for Lifting of Calibration Weights	35
5.2	Front Panel Calibration	36
5.2.1	One-Fork Calibration	36
5.2.2	Two-Fork Linear Calibration	37
5.3	Rezero Calibration	37
<b>6.0</b>	<b>WiFi Configuration</b>	<b>38</b>
6.1	WiFi Setup	38
6.2	Wireless Module Specifications	41
<b>7.0</b>	<b>Bluetooth® Configuration</b>	<b>43</b>
7.1	Bluetooth® Setup	43
7.2	Bluetooth® Specifications	45
<b>8.0</b>	<b>Cableless Option</b>	<b>46</b>
8.1	Zigbee Module Installation	46
<b>9.0</b>	<b>EDP Commands</b>	<b>47</b>
9.1	Key Press Commands	47
9.2	Reporting Commands	48
9.3	Reset Configuration Command	48
9.4	Parameter Setting Commands	49
9.5	Wireless Setting Commands	50
9.6	Serial Port Setting Commands	50
9.7	Stream Setting Commands	50
9.8	Program Commands	51



Technical training seminars are available through Rice Lake Weighing Systems.  
 Course descriptions and dates can be viewed at [www.ricelake.com/training](http://www.ricelake.com/training)  
 or obtained by calling 715-234-9171 and asking for the training department.

9.9	Print Format Commands .....	51
9.10	Weigh Mode Commands .....	52
<b>10.0</b>	<b>Print Formatting .....</b>	<b>53</b>
10.1	Print Formatting Tokens .....	53
10.2	Customizing Print Formats .....	55
10.2.1	Using the Front Panel .....	55
10.3	Non-Human Readable Characters .....	55
<b>11.0</b>	<b>Appendix .....</b>	<b>56</b>
11.1	Error Messages .....	56
11.1.1	Displayed Error Messages .....	56
11.2	ZZ EDP Command .....	56
11.3	Continuous Data (Stream) Output Formats .....	57
11.3.1	Rice Lake Weighing Systems Stream Format (RLWS) .....	57
11.3.2	Cardinal Stream Format (cardnal) .....	57
11.3.3	Avery Weigh-Tronix Stream Format (wtronix) .....	58
11.3.4	Mettler Toledo Stream Format (toledo) .....	58
11.4	Custom Stream Formatting .....	59
11.5	ASCII Character Chart .....	61
11.6	Audit Trail Support .....	61
11.7	Conversion Factors for Secondary Units .....	62
11.8	Front Panel Display Characters .....	62
<b>12.0</b>	<b>Specifications .....</b>	<b>63</b>



Rice Lake continually offers web-based video training on a growing selection of product-related topics at no cost. Visit [www.ricelake.com/webinars](http://www.ricelake.com/webinars)

# 1.0 Introduction

This manual is intended for use by service technicians responsible for installing and servicing a CLS-680 Forklift Scale Display. Configuration and calibration of the CLS-680 can be accomplished using the front panel keys.



Manuals are available from Rice Lake Weighing Systems at [www.ricelake.com/manuals](http://www.ricelake.com/manuals)

Warranty information is available at [www.ricelake.com/warranties](http://www.ricelake.com/warranties)

## 1.1 Safety

### Safety Definitions:



**DANGER:** Indicates an imminently hazardous situation that, if not avoided, will result in death or serious injury. Includes hazards that are exposed when guards are removed.



**WARNING:** Indicates a potentially hazardous situation that, if not avoided, could result in serious injury or death. Includes hazards that are exposed when guards are removed.



**CAUTION:** Indicates a potentially hazardous situation that, if not avoided, could result in minor or moderate injury.



**IMPORTANT:** Indicates information about procedures that, if not observed, could result in damage to equipment or corruption to and loss of data.

### General Safety



*Do not operate or work on this equipment unless this manual has been read and all instructions are understood. Failure to follow the instructions or heed the warnings could result in injury or death. Contact any Rice Lake Weighing Systems dealer for replacement manuals.*



**WARNING:** Failure to heed could result in serious injury or death.

*Some procedures described in this manual require work inside the enclosure. These procedures are to be performed by qualified service personnel only.*

*Ensure the power cord is disconnected from the outlet before opening the unit.*

*Do not allow minors (children) or inexperienced persons to operate this unit.*

*Do not operate without the enclosure completely assembled.*

*Do not use for purposes other than weight taking.*

*Do not place fingers into slots or possible pinch points.*

*Do not use this product if any of the components are cracked.*

*Do not exceed the rated specification of the unit.*

*Do not make alterations or modifications to the unit.*

*Do not remove or obscure warning labels.*

*Do not use solvents or aggressive substances to clean the product.*

*Do not submerge.*

## 1.2 FCC Compliance

### United States

This equipment has been tested and found to comply with the limits for a Class A digital device, pursuant to Part 15 of the FCC Rules. These limits are designed to provide reasonable protection against harmful interference when the equipment is operated in a commercial environment. This equipment generates, uses, and can radiate radio frequency energy and, if not installed and used in accordance with the instruction manual, may cause harmful interference to radio communications. Operation of this equipment in a residential area is likely to cause harmful interference in which case the user will be required to correct the interference at his own expense.

### Canada

This digital apparatus does not exceed the Class A limits for radio noise emissions from digital apparatus set out in the Radio Interference Regulations of the Canadian Department of Communications.

Le présent appareil numérique n'émet pas de bruits radioélectriques dépassant les limites applicables aux appareils numériques de la Class A prescrites dans le Règlement sur le brouillage radioélectrique édicté par le ministère des Communications du Canada.

## 1.3 Operating Modes

### Weigh Mode

Weigh mode is the default mode of the CLS-680. The CLS-680 displays gross or net weights as required, using the annunciators to indicate scale status and the type of weight value displayed.

### User Mode

User mode is accessible by pressing the MENU key on the front panel. Access to the Audit, Accumulator (Accum), Tare, Time, Date, MAC ID, Version (Vers) and J-box Information (JBinfo) menus is available when in user mode.

### Setup Mode

Most of the procedures described in this manual, including calibration, require the CLS-680 to be in setup mode. See [Section 4.0 on page 24](#) for the procedure to enter setup mode and the parameters available.



## 2.0 Installation

This section describes procedures for mounting and connecting cables to a CLS-680 Forklift Scale Display. An assembly drawing and parts list are included for the service technician.



**WARNING**



*Risk of electrical shock.  
Risque de choc.*



*Disconnect power before servicing.  
Débranchez l'alimentation avant l'entretien.*



**AVERTISSEMENT**



**CAUTION:** *Risk of explosion if battery is replaced by an incorrect type. Dispose of used batteries according to state and local regulations.*



**ATTENTION:** *Risque d'explosion si la batterie est remplacée par un type incorrect. Mettre au rebut les batteries usagées selon les règlements d'état et locaux.*



**WARNING:** *Failure to heed the following statements could result in serious injury or death.*

- *Procedures requiring work inside the product enclosure must be performed by qualified service personnel only.*
- *Use a grounding wrist strap to protect components from electrostatic discharge (ESD) damage when working inside the product enclosure.*
- *The power outlet must be near the equipment and must be easily accessible.*

### 2.1 Unpacking

Immediately after unpacking, visually inspect the CLS-680 to ensure all components are included and undamaged. The shipping carton contains the CLS-680, this manual and a parts kit (Section 2.9 on page 15). If parts were damaged in shipment, notify Rice Lake Weighing Systems and the shipper immediately.

#### 2.1.1 Product Dimensions

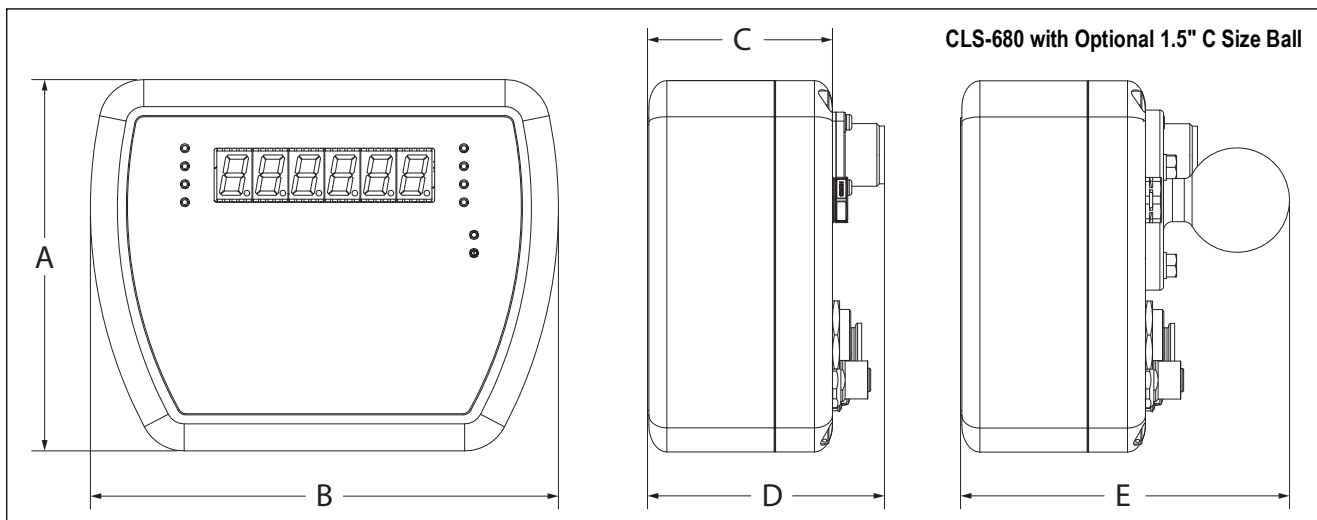

Figure 2-1. Product Diagram

A	B	C	D	E
5.2 in (132.1 mm)	6.5 in (165.1 mm)	2.5 in (63.5 mm)	3.3 in (83.8 mm)	4.6 in (116.8 mm)

Table 2-1. Product Dimensions

## 2.2 Mounting Instructions

The CLS-680 backplate includes three threaded holes for mounting. Figure 2-2 provides the dimensions of the backplate mounting holes.

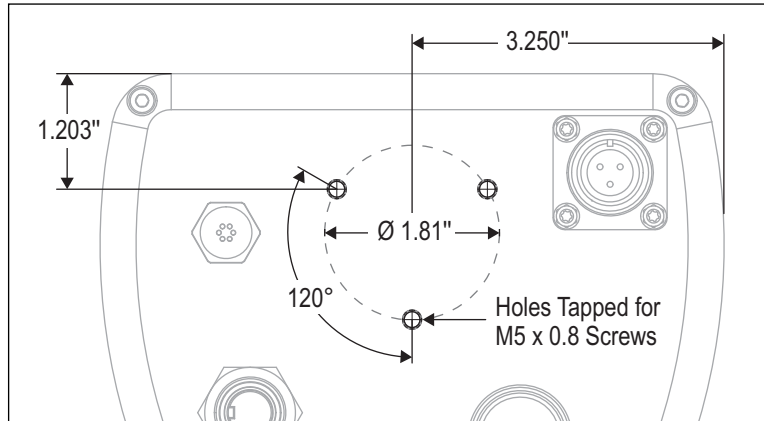

Figure 2-2. Mounting Hole Dimensions

 **NOTE:** Torque mounting screws to 22 in-lb (2.5 N-m).

### 2.2.1 RAM Mounting

The following procedure shows how to use the optional RAM mounting option to secure the CLS-680 to a forklift frame.

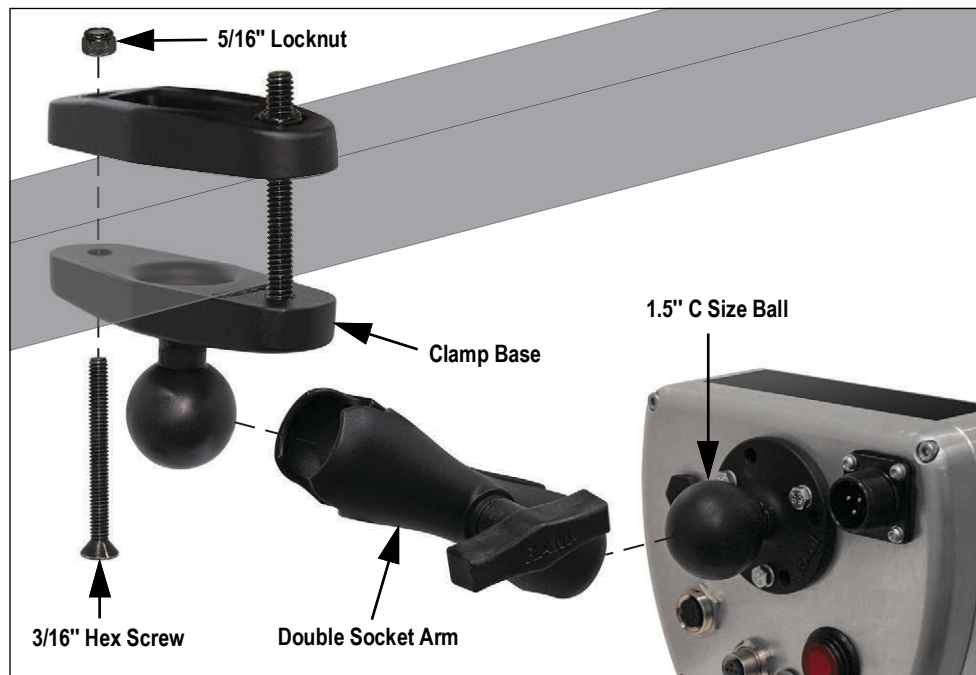

Figure 2-3. RAM Mounting Option

1. Secure the RAM mount clamp base with 1.5" C size ball to the forklift frame with two screws and locknuts. Tools needed for this step are a 1/2" wrench and a 3/16" hex key (Figure 2-3).
2. Loosely attach the RAM mount double socket arm to the 1.5" C size ball of the clamp base.
3. Position the CLS-680 1.5" C size ball into the open end of the RAM mount double socket arm and tighten down the nob until both balls are secured firmly.

 **NOTE:** Loosen and tighten the RAM mount double socket arm nob as needed to appropriately position the CLS-680 display for the forklift operator.

## 2.3 External Cable Connections

The CLS-680 provides connection ports on the back of the enclosure. The connection ports are used for power, junction box connection and serial communications.

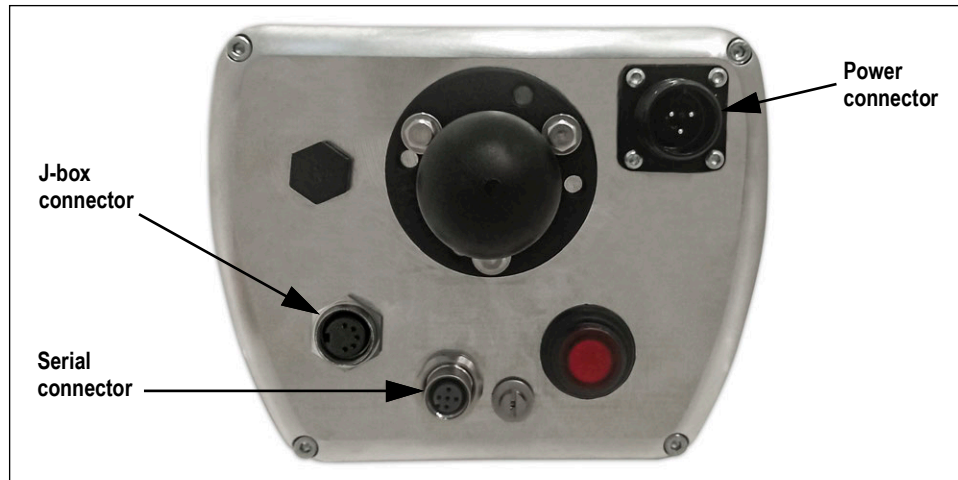

Figure 2-4. Cable Connection Locations (Optional RAM Mount Shown)

### 2.3.1 Power Connector

A male 3-pin connector for the power cable connection is located on back of the enclosure. See Figure 2-5 and Table 2-2 for the connector pin assignments.

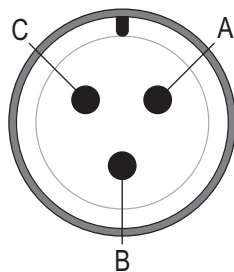

Figure 2-5. Power Connector

Pin	Signal
A	Positive (+)
B	Negative (-)
C	Chassis Ground

Table 2-2. Power Connector Pin Assignments

### 2.3.2 Junction Box Connector

A female M16 connector for the J-box cable connection is located on back of the enclosure. See Figure 2-6 and Table 2-3 for the connector pin assignments.

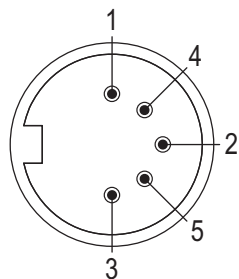

Figure 2-6. J-Box Connector

Pin	Color	Signal
1	Brown	Power
2	White	Ground
3	Blue	TX1
4	Black	RX1
5	Gray	Heart Beat Signal

Table 2-3. J-Box Connector Pin Assignments

### 2.3.3 Serial Connector

A female M12 connector for the serial cable connection is located on back of the enclosure. See [Figure 2-7](#) and [Table 2-4](#) for the connector pin assignments.

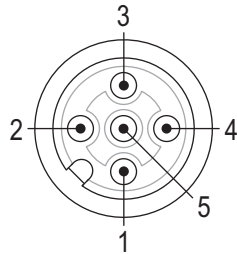

Figure 2-7. Serial Connector

Pin	Color	Signal
1	Brown	5 V+ Power
2	White	Power/Signal Ground
3	Blue	TX2
4	Black	RX2
5	Green/Yellow	GND

Table 2-4. Serial Connector Pin Assignments

## 2.4 Interior Access

Open the enclosure of the CLS-680 to gain access and connect cables to the CPU and power supply boards.



**WARNING:** Before opening the unit, ensure the power cord is disconnected from the power source.

1. Place the CLS-680 face-down on an anti-static work mat.
2. Remove the four screws holding the backplate to the enclosure with a 3 mm hex key.



**NOTE:** The power supply board is secured to the backplate and the CPU board is secured to the front side of the enclosure. Use caution when opening the enclosure to avoid pulling on the wires connecting the two boards.

3. Swing the backplate open and place it next to the enclosure on the anti-static work mat.

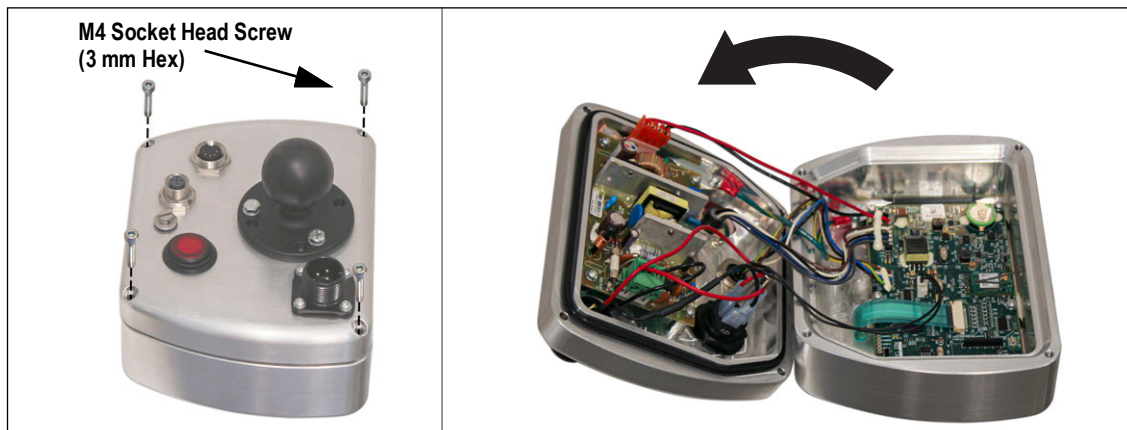

Figure 2-8. Enclosure Opening

### 2.4.1 Backplate Reattachment

Once work inside of the enclosure is complete, reposition the backplate over the enclosure and install the four backplate screws. Snug up the four screws evenly before fully securing the backplate to prevent distorting the backplate gasket. After the four screws are evenly snug, torque screws to 19 in-lb (2.2 N-m).



**NOTE:** Torqued screws may become less tight as the gasket is compressed. A second torque of the screws might be necessary to achieve the required torque value.

## 2.5 Updating Firmware

Revolution® Scale Software is used to update the firmware of the CLS-680. Revolution is available for download from Rice Lake Weighing Systems at [www.ricelake.com/products/revolution-scale-software/](http://www.ricelake.com/products/revolution-scale-software/). The **Update Firmware** link to begin this process is available on the CLS-680 home screen within Revolution. A step-by-step procedure appears once the link is clicked.

Updating the firmware defaults the configuration and calibration settings.

## 2.6 CPU Board

For normal operation of the CLS-680, the run switch (SW1) and program switch (SW3) need to be in the RUN position as illustrated in [Figure 2-9](#). The micro USB (J5) connector is reserved for firmware updates only and is not setup as a communications port.

The audit switch (SW2) controls setup mode access. See [Section 4.1.1 on page 24](#) for details on the audit switch.

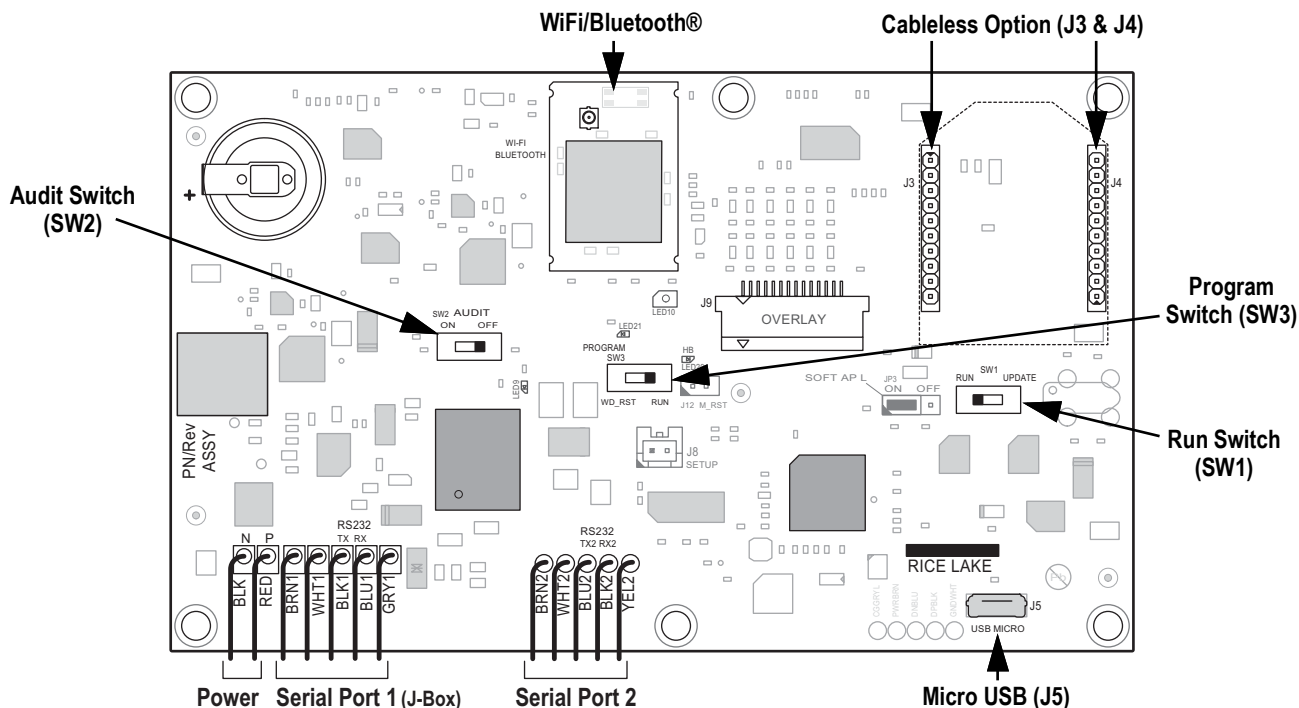

Figure 2-9. CLS-680 CPU Board

**NOTE:** T-10 Torx head screws are used to secure the CPU board, Power board and grounding locations.

## 2.7 DC Power Board

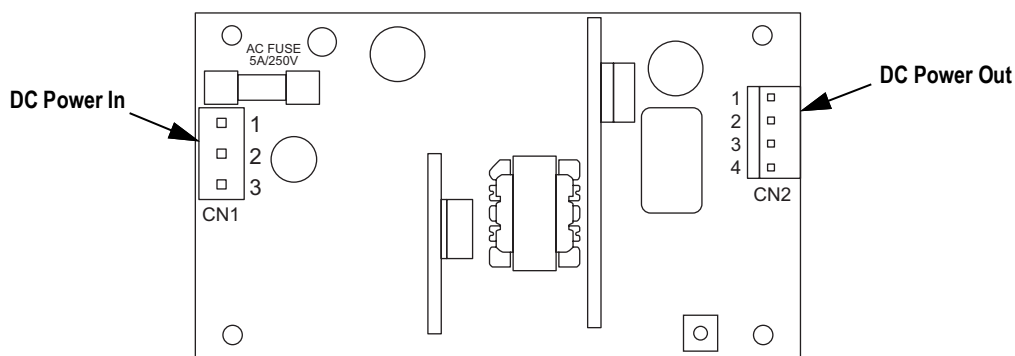

Figure 2-10. DC Power Supply Board

Connector	Pin	Function
CN1	1	DC In (+V)
	2	Not Used
	3	DC In (-V)

Connector	Pin	Function
CN2	1,2	DC Out (+V)
	3,4	DC Out (-V)

Table 2-5. DC Power Pin Assignments

## 2.8 Replacement Parts

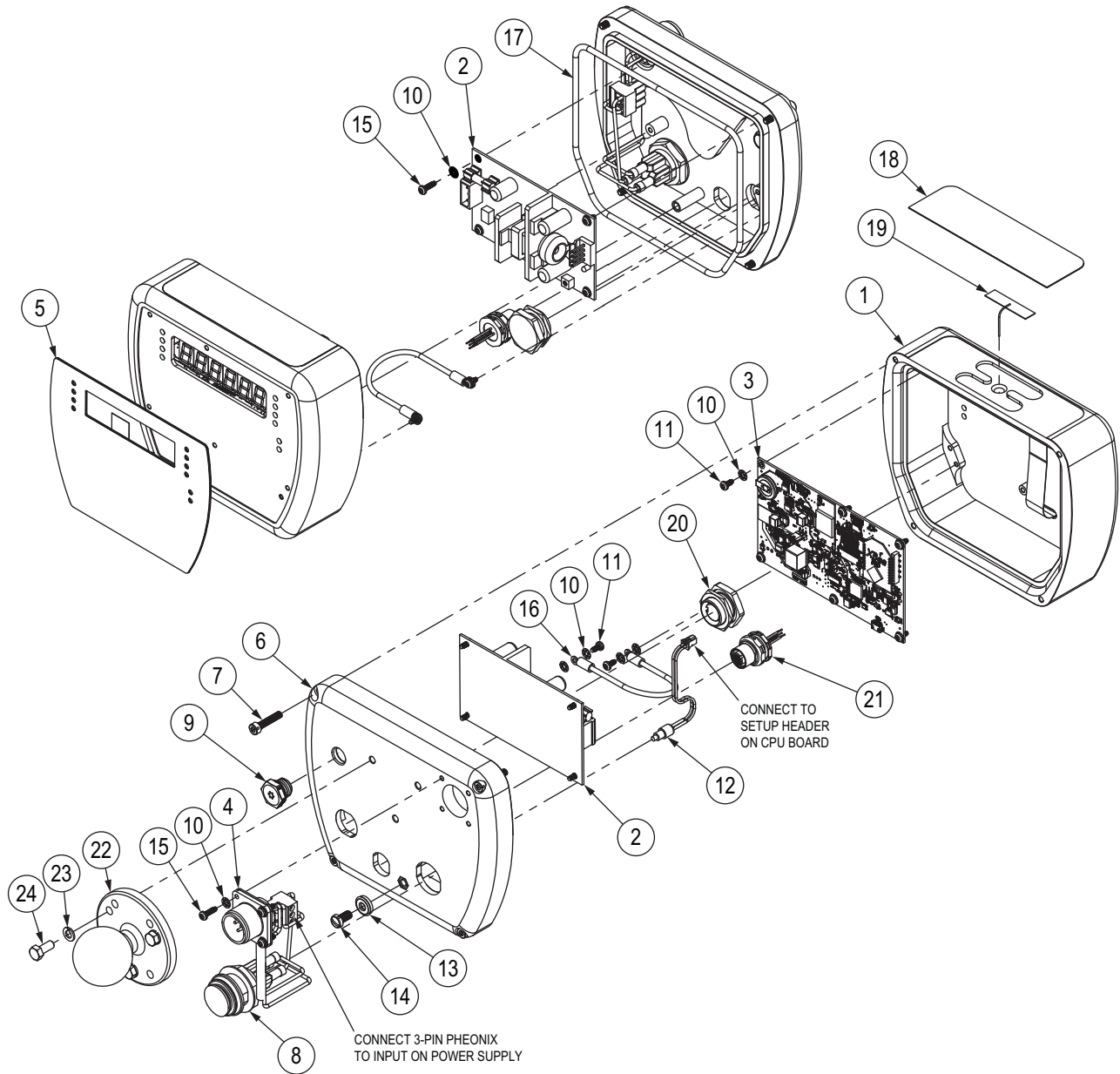

Figure 2-11. Replacement Parts Diagram

## 2.8.1 Replacement Parts List

Item No.	Part No.	Description	Qty
1	212174	Enclosure, CLS-680 Display Machined Aluminum	1
2	132750	Power Supply, DC/DC +7.5V 9-36VDC Input	1
	198397	Power Supply, 18-72VDC Input with Load Dump Protection, 12VDC Output	
3	212200	Board Assembly, CLS-680 Replacement CPU with xPico Wireless	1
4	200189	Cable, MS 3-Pin Connector Lead Wires, 3 Terminal Connector 9-36V Configuration	1
5	198062	Overlay, CLS-680 Display Membrane Switch with Numeric Keys	1
6	213981	Back Cover, CLS-680 Machined Aluminum with Standoff Installed	1
7	199703	Screw, M4 x 0.7 x 20 mm Drilled Socket Head Cap Screw Zinc Plated	4
8	200179	Switch, Latching Pushbutton SPST 10A 14V Illuminated Red IP67	1
9	164598	Breather Vent M12 x 1	1
10	15127	Washer, Lock No. 4 Type A Internal Tooth Zinc Pltd	18
11	199702	Screw, M3 x 6 mm Pan Head Torx Thread Forming Zinc Plated	8
12	200171	Setup Switch Assembly, Remote CLS-680	1
13	46381	Washer, Bonded Sealing SST #10 x 0.50 OD	1
14	180861	Screw, Machined M5 x 0.8 x 10 mm Slotted Drilled Chess Head SST	1
15	200461	Screw, M3-0.5 x 10 mm Pan Head Torx Thread Forming Zinc Plated	8
16	200170	Wire Assembly, Ground 6 Inch with No. 4 Ring Terminals Both Ends	1
17	200267	O-Ring, 1/8 Inch ID BUNA-N Vulcanized	1
18	201325	Overlay, CLS-680 Antenna Cover, Black	1
19	206363	Antenna, 2.4/5 GHz Strip U.FL Termination 50 mm with Adhesive	1
20	200257	Connector, M16 6" Rear Mount Turck BKFD 5-5-0.15	1
21	163766	Connector, M12 with Cable Assembly	1
-	202989	CLS-680 Forklift Scale Display Parts Kit ( <a href="#">Section 2.9</a> )	1
Replacement Parts Specific to RAM Mount Option			
22	200762	RAM Mount, 1.5" C Size Ball with 2.5" Round Base Plate (RAM-202U)	1
23	200181	Washer, Split Lock M5 Steel Zinc Plated	3
24	200182	Screw, Cap M5 x 0.8 x 12 mm Hex Head	3
-	175509	RAM Mount, Double Socket Arm, 5.69" Length, for 1.5" C Size Ball (RAM-201U)	-
	200763	RAM Mount, Clamp Base for Square Posts up to 3" Wide with 1.5" C Size Ball (RAM-247U-3)	-
	200764	RAM Mount, Clamp Base for Square Posts up to 4" Wide with 1.5" C Size Ball (RAM-247U-4)	-
	200765	RAM Mount, Clamp Base for Square Posts up to 5" Wide with 1.5" C Size Ball (RAM-247U-5)	-

Table 2-6. Replacement Parts List

## 2.9 Parts Kit Components

Part No.	Description	Qty
200181	Washer, M5 Split Lock DIN 127 Zinc Plated	3
200182	Bolt, M5 x 0.8 x 12 mm HEX Head Cap Screw DIN 933 Class 8.8 Zinc Plated	3
94422	Label, Capacity 0.40 x 5.00	1

Table 2-7. Parts Kit (PN 202989) Components



## 2.10 Torque Ratings

Refer to [Table 2-8](#) throughout installation and use of product to maintain proper torque ratings for CLS-680 components.

Component	Torque Rating
Backplate Screws and Power Button Nut	19 in-lb (2.2 N-m)
Setup Switch Screw and Optional Ball Mount Screws	22 in-lb (2.5 N-m)
Serial Connector Nut	13 in-lb (1.5 N-m)
Junction Box Connector Nut	33 in-lb (3.7 N-m)
Breather Vent	10 in-lb (1.1 N-m)
CPU and Power Board Screws and Power Connector Screws	9 in-lb (1.0 N-m)

Table 2-8. Component Torque Ratings

## 2.11 Sealing the Enclosure (Optional)

Insert a lead wire seal through three fillister screws. This restricts access of the setup switch, audit switch, electronics, electrical contacts and Legal for Trade configuration parameters.



**NOTE:** Audit switch (SW2) must be switch to off to require pressing the setup switch for access to configuration parameters.



Figure 2-12. Sealing the Enclosure – No Access

1. Make sure the backplate screws and setup screw are torqued as specified in [Section 2.10](#).
2. Navigate the sealing wire through the drilled holes of the setup screw and two of the backplate screws ([Figure 2-12](#)).
3. Seal the wire to secure.



## 3.0 Operation

The front panel consists of a seven-segment display with six 0.5 in (12.7 mm) tall digits. A negative number displays as five digits plus the negative symbol. Front panel also includes 18 flat membrane panel, tactile feel buttons, which include six primary scale function buttons and a numeric keypad. There are ten LED annunciators for units, scale functions and wireless communication.

### 3.1 Power Button

Use the red push button switch on the backside of the enclosure to turn the CLS-680 ON and OFF.

### 3.2 Front Panel



Figure 3-1. CLS-680 Front Panel

Key	Function
	The Menu key is used to access user mode; See <a href="#">Section 4.1.1 on page 24</a> for more information on setting up the Menu key to access setup mode parameters
	Sets the current gross weight to zero, provided the amount of weight to be removed or added is within the specified zero range and the scale is not in motion; The zero band is defaulted to 1.9% of full scale, but can be configured for up to 100% of full scale; Also used as the up key to navigate menus
	Switches the weight display to an alternate unit; The alternate unit is defined in the Configuration menu, and could be kg, g, lb, oz, tn or t; Also used as the left key to navigate menus or to toggle to another digit when editing a value
	Sends on-demand print format out the configured port, provided the conditions for standstill are met; RS232 is the default print port; Also used as the right key to navigate menus or to toggle to another digit when editing a value
	Performs one of several predetermined Tare functions dependent on the mode of operation selected in the TAREFN parameter; Also acts as an enter key for numeric or parameter entry
	Switches the display mode from gross to net, or from net to gross; If a tare value has been entered or acquired, the net value is the gross weight minus the tare; Gross mode is represented by the Gross/Brutto annunciator; net mode is represented by the Net annunciator; Also used as the down key to navigate menus
	Clears current value in a numeric entry or clears the currently selected digit in an alphanumeric entry

Table 3-1. Buttons and Descriptions

### 3.3 LED Annunciators

The CLS-680 display uses a set of eight LED annunciators to provide additional information about the value being displayed.

LED	Description
<b>Gross Brutto</b>	Gross/Brutto LED – Gross weight display mode
<b>Net</b>	Net LED – Net weight display mode
<b>→0←</b>	The Center of Zero LED – Indicates the current gross weight reading is within $\pm 0.25$ display divisions of the acquired zero, or is within the center of zero band; A display division is the resolution of the displayed weight value, or the smallest incremental increase or decrease which can be displayed or printed
	Standstill LED – Scale is at standstill or within the specified motion band; Some operations, including zero, tare and print, can only be done when the standstill LED is on
<b>lb</b>	lb and kg LEDs:
<b>kg</b>	Displays which unit of measure is being used; lb and kg annunciators indicate the units associated with the displayed value; The displayed units can also be set to short tons (tn), metric tons (t), ounces (oz), grams (g) or none (no units information displayed); The lb and kg LEDs function as primary and secondary units annunciators; If neither primary nor secondary units are lb or kg, the lb annunciator is lit for primary units and kg is lit for secondary units
<b>T</b>	Tare LED – Indicates a push-button tare weight has been acquired and stored in memory
<b>PT</b>	Preset Tare LED – Indicates a preset tare weight has been keyed in or entered and stored in memory
<b>Bluetooth®</b>	Bluetooth® LED (blue) – Indicates wireless module is ON and WIFIBT parameter is set to Bluetooth®; LED does not indicate if there is an active Bluetooth® connection
<b>WiFi</b>	WiFi LED (green) – Indicates wireless module is ON and WIFIBT parameter is set to WiFi; LED does not indicate if there is a connection

Table 3-2. LED Annunciators

### 3.4 General Navigation

The front panel scale function buttons are also used to navigate through the menu structure.

- and move left and right (horizontally) in a menu level
- and move up and down to different menu levels
- enters a menu or parameter and selects parameter settings or values
- to access user mode, to leave a parameter without making changes, or to return to weigh mode
- Use the numeric keypad to enter a value and press to accept the value ([Section 3.4.1](#))

#### 3.4.1 Numeric Value Entry

Several parameters in the menu structure require the entry of a numeric value rather than the making of a selection.

Follow this procedure to enter a numeric value:

1. Press or to enter into a parameter. The current parameter value displays.
2. Press to clear the current value.
3. Use the numeric keypad to enter a new value.
4. If necessary, press to make the value negative.
5. Press to save the new value,  $\alpha F$  displays.
6. Press , the next parameter in the menu displays.



**NOTE:** Pressing also saves the new value, but the display returns up to the current parameter, rather than to the next parameter in the menu.

### 3.4.2 Alphanumeric Entry

Several parameters in the menu structure require the entry of an alphanumeric value rather than the making of a selection.



**NOTE:** The end of the alphanumeric character string is indicated by the “\_.” character symbol.

Follow this procedure to enter an alphanumeric value:

1. Press or to enter into the parameter. The current parameter entry displays.
2. Press or to move to the character to be edited.
3. Press to enter into the character options for the location at the far right of the display.
4. Press or to scroll through available character or use the numeric keypad to enter in the ASCII value of the intended character ([Section 11.5 on page 61](#)).
5. Press to select the currently displayed character. The selected character displays in the second display field.
6. Press to enter into the character options again for the next character.
7. Press again or press to clear the current character.
8. Repeat the previous steps until alphanumeric entry is complete.
9. Press to save the new entry.



**NOTE:** Press to leave the parameter without saving the changes.

## 3.5 General Operation

This section summarizes basic CLS-680 operations.

### 3.5.1 Zero Scale

1. In gross mode, remove all weight from the scale and wait for the LED to light.
2. Press . The LED lights to indicate the scale is zeroed.



**NOTE:** The scale must be stable and within the configured zero range for the scale to be zeroed. If the scale cannot be zeroed, see [Section 11.1.1 on page 56](#).

### 3.5.2 Print Ticket

1. Wait for the LED to be lit.
2. Press to send data to the configured port. The default print port is RS232 ([Section 4.4.6 on page 31](#)).

If the LED is not lit and is pressed, the print action only occurs if the scale comes out of motion within three seconds. If the scale stays in motion for over three seconds, the press is ignored.

### 3.5.3 Toggle Units



Press to toggle between primary and secondary units. The current unit LED is lit.

### 3.5.4 Toggle Gross/Net Mode





Net mode is available when a tare value has been entered or acquired (Net = Gross minus Tare). If tare has not been entered or acquired, the display remains in gross mode. The LED next to Gross or Net indicates the current mode.

Press to toggle the display mode between gross and net.

### 3.5.5 Acquire Tare



1. Place a container on the scale and wait for the  LED to become lit.
2. Press  to acquire the tare weight of the container. The net weight displays and the **Net** LED and **T** LED annunciators become lit, confirming the tare value was entered.

### 3.5.6 Remove Stored Tare Value



1. Remove all weight from the scale and wait for the  LED to become lit. The display reads the negative tare value and the  LED is lit.
2. Press  to zero the scale, if needed.
3. Press . Display changes to gross weight and the **Gross** LED becomes lit.

### 3.5.7 Preset Tare (Keyed Tare)







Tare mode must be set to keyed or both for the preset tare feature to function.

1. Remove all weight from the scale and wait for the  LED and  LED to become lit.
2. With the scale displaying zero weight, use the numeric keypad to enter the tare weight value and press .
3. The display changes to net weight and the **Net** LED and **PT** LED become lit, confirming the preset tare was entered.













**NOTE:** Press  again while the  LED is lit, or enter a keyed tare of zero to remove the preset tare value.

### 3.5.8 Display a Stored Tare

1. Press . **AUDIT** displays.
2. Press  or  until **TARE** displays.
3. Press . **DISPLAY** displays.
4. Press . The stored tare value displays.
5. Press  twice to return to weigh mode.









If there is not a tare in the system, the value displayed is zero.

### 3.5.9 Clear a Stored Tare







1. Press . **AUDIT** displays.
2. Press  or  until **TARE** displays.
3. Press . **DISPLAY** displays.
4. Press . **CLR TARE** displays.
5. Press  or  to clear the stored tare value. **00** displays.
6. Press  or  to return the audit menu.
7. Press  to return to weigh mode.

### 3.5.10 View Audit Trail Counters

The audit trail calibration and configuration counters can be viewed in user mode.









1. Press . *AUDIT* displays.
2. Press . *LRU* displays.
3. Press . *CALLIB* displays.
4. Press . The audit trail calibration counter displays.
5. Press . *CALLIB* displays.
6. Press . *CONF* displays.
7. Press . The audit trail configuration counter displays.
8. Press  twice to return to weigh mode.

### 3.5.11 View Legally Relevant Version











1. Press . *AUDIT* displays.
2. Press . *LRU* displays.
3. Press . The legally relevant version displays.
4. Press  or  to return the audit menu parameters.
5. Press  twice to return to weigh mode.

### 3.5.12 Display Accumulator











The accumulator value can be viewed in user mode. Accumulation occurs when printing in weigh mode.

1. Press . *AUDIT* displays.
2. Press  or  until *ACCUM* displays.
3. Press . *DISPACC* displays.
4. Press . The accumulator value displays.
5. Press  or  to return the accumulator menu parameters.
6. Press  to return to weigh mode.

### 3.5.13 Print Accumulator





1. Press . *AUDIT* displays.
2. Press  or  until *ACCUM* displays.
3. Press . *DISPACC* displays.
4. Press . *PRTACC* displays.
5. Press  or  to print the accumulator value. *OFF* displays.
6. Press  or  to return the accumulator menu parameters.
7. Press  to return to weigh mode.

### 3.5.14 Clear Accumulator

1. Press .  $\bar{A}Ud, E$  displays.
2. Press  or  until  $\bar{A}CCU\bar{A}$  displays.
3. Press .  $\bar{A}SPAC\bar{A}$  displays.
4. Press .  $\bar{C}LR\bar{A}C\bar{A}$  displays.
5. Press  or  to clear the accumulator value.  $\bar{A}F$  displays.
6. Press  or  to return the accumulator menu parameters.
7. Press  to return to weigh mode.







### 3.5.15 Enter New Unit ID

Entering a new Unit ID requires access to setup mode ([Section 4.1 on page 24](#)).

1. Access the setup menu by pressing the setup switch.  $\bar{C}ONF, E$  displays.
2. Press .  $\bar{N}o\bar{d}E$  displays.
3. Press  to scroll until  $\bar{U}, d$  displays.
4. Press . The current unit ID value displays.
5. Edit the value using the keypad and the numeric value entry procedure ([Section 3.4.1 on page 18](#)).
6. Press  when the value is correct,  $\bar{A}F$  displays.
7. Press  twice to return to weigh mode.

### 3.5.16 View and Edit Time Value

To view and edit the current time:







1. Press .  $\bar{A}Ud, E$  displays.
2. Press  multiple times until  $\bar{E}, \bar{N}E$  displays.
3. Press  to view the current set time.
4. To edit the time value use the following method:
  - Press  to clear the current time
  - Use the numeric keypad to enter the new time value in 24 hour format
  - Press  to accept the new time value once correct;  $\bar{A}F$  displays
5. Press  twice to return to weigh mode.



**NOTE:** Time is backed up by the internal battery and is not lost if the main power is interrupted. See [Section 4.4.5 on page 29](#) for time formatting options.

### 3.5.17 View and Edit Date Value

To view and edit the current date:











1. Press .  $\bar{A}Ud, t$  displays.
2. Press  multiple times until  $dRtE$  displays.
3. Press  to view the current set date.
4. To edit the date value use the following method:
  - Press  to clear the current date
  - Use the numeric keypad to enter the new date value in MMDDYY format
  - Press  to accept the new date value once correct;  $\alpha F$  displays
5. Press  twice to return to weigh mode.



**NOTE:** Date is backed up by the internal battery and is not lost if the main power is interrupted. See [Section 4.4.5 on page 29](#) for date formatting options.





### 3.5.18 WiFi and Bluetooth® MAC IDs

With WiFi established ([Section 4.7 on page 34](#)), the WiFi MAC ID ( $\bar{u}, F, i$ ) and the Bluetooth® MAC ID ( $bEt\alpha\alpha tH$ ) can be viewed through the top-level menu using the front panel of CLS-680.

1. Press .  $\bar{A}Ud, t$  displays.
2. Press  or  to scroll through the menu options until  $\bar{n}Rt, d$  displays.
3. Press .  $\bar{u}, F, i$  displays.
4. Press .  $88-88-88-88-88-88$  displays. Press  to scroll through the entire MAC address.
5. Press .  $\bar{u}, F, i$  displays.
6. Press .  $bEt\alpha\alpha tH$  displays.
7. Press .  $88-88-88-88-88-88$  displays. Press  to scroll through the entire MAC address.
8. Press  twice to return to weigh mode.





### 3.5.19 Default Configurable Parameters

Resets configurable CLS-680 or J-Box parameter settings to their defaults. See [Section 4.4.8 on page 33](#) for additional details.

1. Access setup mode by pressing the setup switch ([Section 4.1 on page 24](#)).  $\bar{C}\alpha nF, t$  displays.
2. Press .  $dEFtE$  displays.
3. Press .  $\bar{C}L5b88$  displays.
4. Press  or  to toggle to the JBOX default parameter, if needed.



**NOTE:** The CLS-680 offers the ability to default the associated junction box hardware.

5. Press .  $\alpha\alpha$  displays.
6. Press .  $\bar{Y}E5$  displays.
7. Press  or  to reset the configuration settings (for  $\bar{C}L5b88$  or  $\bar{J}b\alpha\alpha$ ).  $\alpha F$  displays.
8. Press  twice to return to weigh mode.

## 4.0 Configuration

There are two types of configuration parameters in the CLS-680, setup mode parameters (or Legal for Trade configuration) and user mode parameters (or non-legal configuration). Setup mode parameters are accessed by pressing the setup switch (Section 4.1). User mode parameters are accessed by pressing the menu button and do not require pressing the setup switch.

The following sections provide graphic representations of the CLS-680 menu structures. Most menu diagrams are accompanied by a table which describes all parameters and parameter values associated with the menu.

The audit, accumulator, tare, time, date, Mac ID and version menus can be accessed by pressing  in user mode. The setup menu is accessed by pressing the setup switch (Section 4.1) and entering the setup mode.



**NOTE:** All weight related parameters must be configured prior to calibrating the unit (Section 4.4.1 on page 26).

### 4.1 Setup Switch

In order to configure the CLS-680, it must be placed in setup mode with the setup switch. The setup switch is accessed through a small hole on the back of the enclosure. Remove the setup switch screw and insert a non-conductive tool into the access hole to press the setup switch.



**IMPORTANT:** Use caution when inserting the non-conductive tool into the enclosure. Insert the tool about 3/4 in (19 mm), until the switch is engaged. Do not use excessive force which could damage the switch.

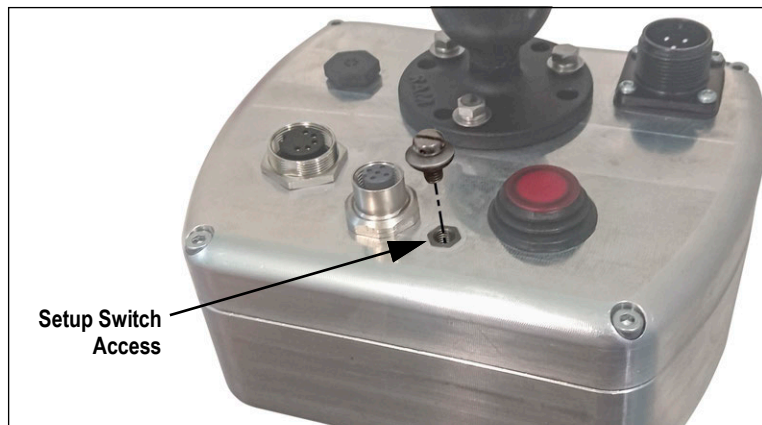

Figure 4-1. Setup Switch Access Location

When the CLS-680 is placed in setup mode, the setup menu is accessed and config displays. See Section 4.4 on page 25 for a detailed breakdown of this menu. Torque the setup switch screw to 22 in-lb (2.5 N-m) when reinserting.

#### 4.1.1 Audit Switch

The audit switch (SW2) turns setup mode access on and off. Access to setup mode is allowed without pressing the setup switch when the audit switch is in the ON position. Access to setup mode requires pressing the setup switch when the audit switch is in the OFF position. See Section 2.6 on page 13 for the location of the audit switch on the CPU board.



**NOTE:** In certain Legal for Trade applications it is necessary to seal the enclosure to restrict access to the setup switch (Section 2.11 on page 16). Breaking of the seal terminates the Legal for Trade status of the CLS-680.



## 4.2 Main Menu



Figure 4-2. Main Menu

Menu	Description
AUdIt	Audit – Displays the legally relevant firmware version and allows access to view/print audit trail information; see <a href="#">Section 4.3</a>
SEtUP	Setup – Set configuration parameters for the CLS-680 (only accessible in setup mode); see <a href="#">Section 4.4</a>
ACCUñ	Accumulator – Displays, prints and clears accumulated weight value; see <a href="#">Section 4.5 on page 33</a>
tAr-E	Tare – Displays and clears stored tare value; see <a href="#">Section 4.6 on page 33</a>
t,ñE	Time – Displays the time and allows the time to be edited (24-hour)
dREtE	Date – Displays the date and allows the date to be edited
ñRC id	MAC ID – Displays the WiFi and Bluetooth® MAC Addresses (read only); see <a href="#">Section 4.7 on page 34</a>
uErS	Version – Displays the installed firmware version number of the CLS-680
Jb,ñFo	J-Box Info – Displays the J-box version and Unit ID (read only); see <a href="#">Section 4.8 on page 34</a>

Table 4-1. Main Menu Descriptions

## 4.3 Audit Menu

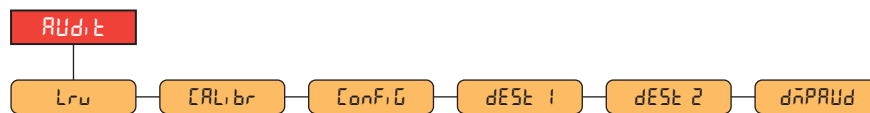

Figure 4-3. Audit Menu

Parameter	Description
Lrv	LRV – Legally relevant firmware version
CALibr	Calibration – Displays total number of calibration events (read only)
ConF	Configuration – Displays total number of configuration events (read only)
dESt 1	Destination Port 1 – Audit trail port; Settings: <b>RS232</b> (default), WIFIBT, NONE
dESt 2	Destination Port 2 – Audit trail port; Settings: <b>NONE</b> (default), RS232, WIFIBT
dñPRUD	Dump Audit Trail – Prints the audit parameters to the configured port

Table 4-2. Audit Menu Descriptions

## 4.4 Setup Menu

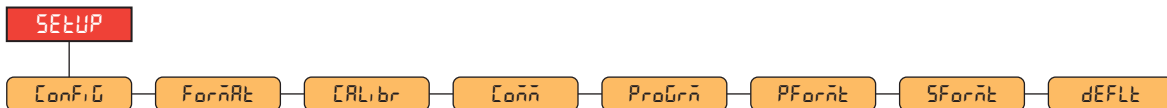

Figure 4-4. Setup Menu

Menu	Description
ConF	Configuration – See <a href="#">Section 4.4.1 on page 26</a> for menu structure and parameter descriptions of the Configuration menu
ForñARt	Format – See <a href="#">Section 4.4.2 on page 27</a> for menu structure and parameter descriptions of the Calibration menu
CALibr	Calibration – See <a href="#">Section 4.4.3 on page 27</a> for menu structure and parameter descriptions of the Calibration menu
Conñ	Communication – See <a href="#">Section 4.4.4 on page 28</a> for menu structure and parameter descriptions of the Communication menu
ProGñ	Program – See <a href="#">Section 4.4.5 on page 29</a> for menu structure and parameter descriptions of the Program menu
PForñt	Print Format – See <a href="#">Section 4.4.6 on page 31</a> for menu structure and parameter descriptions of the Print Format menu
SForñt	Stream Format – See <a href="#">Section 4.4.7 on page 32</a> for menu structure and parameter descriptions of the Stream Format menu
dEFLt	Default Configuration – See <a href="#">Section 4.4.8 on page 33</a> for menu structure and parameter descriptions of the Default menu

Table 4-3. Setup Menu Descriptions

### 4.4.1 Setup – Configuration Menu

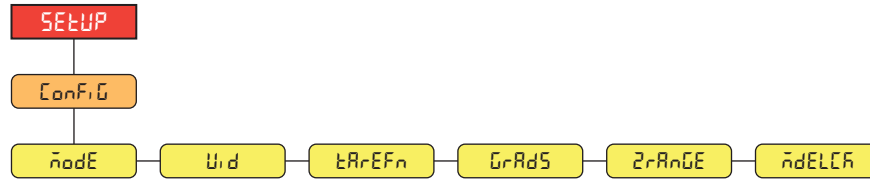

Figure 4-5. Setup – Configuration Menu

Parameter	Description
MODE	User Mode – This is a one-step configuration setting; Modes other than 600 are typically associated to a predefined outcome, commonly to work with specific peripheral equipment; All 6XX modes are defined for use with the CLS-680; <i>Settings:</i> <b>600 (default)</b> – 5000 x 5 lb, equivalent to CLS-420 firmware 99153 <b>601</b> – 5000 x 5 lb, equivalent to CLS-420 firmware 120996 <b>602</b> – 5000 x 5 lb, custom stream format, equivalent to CLS-420 firmware 168996 <b>603</b> – 5000 x 5 lb, serial port termination to CR <b>604</b> – 5000 x 5 lb, equivalent to CLS-420 firmware 183420 <b>605</b> – 5000 x 5 lb, custom stream format, equivalent to CLS-420 firmware 184583 <b>606</b> – 5000 x 5 lb, custom stream format, equivalent to CLS-420 firmware 185069 <b>607</b> – 5000 x 10 lb, custom print format, Measurement Canada configuration <b>608</b> – 5000 x 5 lb, print formats to work with Zebra mobile label printer <b>609</b> – 8000 x 5 lb, Class III forklift scale, Not NTEP approved <b>610</b> – 5000 x 10 lb, Measurement Canada configuration <b>611</b> – 4500 x 5 lb, Measurement Canada configuration <i>*Modes can be changed after calibration without the need to recalibrate.</i>
UID	Unit ID – Specifies unit identification number of the junction box; <i>Enter value: 0–999999, 1 (default)</i>
TAREFN	Tare Function – Enables or disables push-button and keyed tare; <i>Settings:</i> <b>BOTH (default)</b> – Both push-button and keyed tare are enabled <b>NOTARE</b> – No tare allowed (gross mode only) <b>PBTARE</b> – Push-button tares enabled <b>KEYED</b> – Keyed tare enabled
GRAD5	Graduations – The number of unique displayable values from 0 to capacity; <i>Enter value: 1–100000, 1000 (default)</i> <i>Example: Graduations defaults to 1,000 since the capacity is 5,000 and display divisions defaults to 5.</i>
ZERNGE	Zero Range – The total amount the scale can be zeroed; Zero range represents a percentage of capacity; The default value of 1.9 represents $\pm 1.9\%$ around the calibrated zero point, for a total range of 3.8%; A value of 0.0 prevents zeroing; Maximum legal value depends on local regulations; <i>Enter value: 0.0–100.0, 1.90000 (default)</i>
MDLCK	Mode Lock – Specifies if the configured mode is based on the J-box or the CLS-680; when set to OFF, the configured mode is based on the J-box’s mode and when set to ON, the configured mode is base on the CLS-680’s mode; <i>Settings: OFF (default), ON</i>

Table 4-4. Setup – Configuration Menu Descriptions

### 4.4.2 Setup – Format Menu

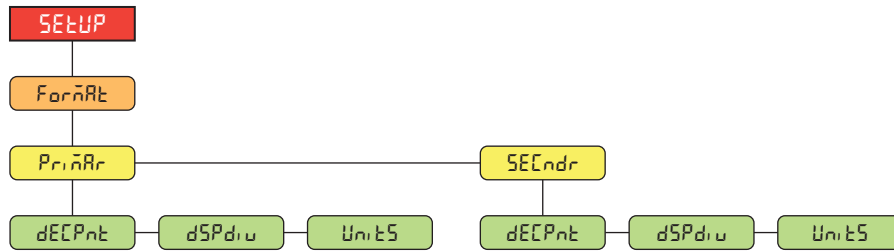

Figure 4-6. Setup – Format Menu

Parameter	Description
dECPnt	Decimal Point – Sets the decimal point for the Primary (Primary) and Secondary (Secondary) display weight formats; Settings: <b>888888</b> (Primary/Secondary default), 88888.8, 8888.88, 888.888, 88.8888, 8.88888, 888800, 888880
dSPd.u	Display Divisions – Sets the display divisions for the Primary (Primary) and Secondary (Secondary) display weight formats; Settings: <b>5d</b> (Primary default), 1d, 2d (Secondary default)
Units	Units – Sets the units type; Settings: <b>LB</b> (Primary default), KG (Secondary default), TN, T, OZ, G, NONE

Table 4-5. Setup – Format Menu Descriptions

### 4.4.3 Setup – Calibration Menu

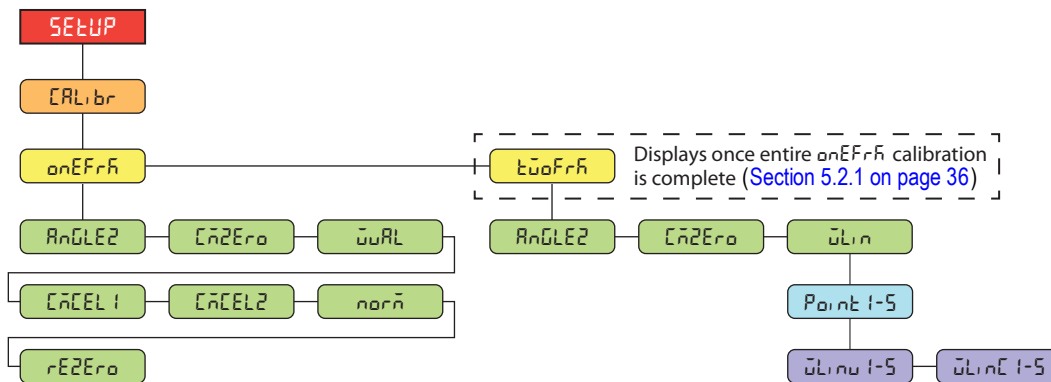

Figure 4-7. Setup – Calibration Menu

Parameter	Description
RnGLE2	Pitch and Roll Angles Zero Calibration – Calibrates the inclinometer pitch and roll angles on the junction box when the pitch and roll angles are zero; this operation tells the junction box to use the current readings from the scale inclinometer and to store these angle measurements as offsets; these offsets are applied to the current measurement angle used in calculating the correction factor that is applied to the weight
CnZEro	Cal-Match Zero Calibration – Tells the junction box that the calibration mode is set for Cal-Match; initialize variables for the calibration then executes the zero calibration
uRL	Test Weight Value – Sets the test weight value; Enter value: 0.00001–5000.0, <b>1000.0</b> (default)
CnCEL 1-2	Cal-Match Load Cell 1-2 Calibrations – Executes a single fork calibration for the corresponding load cell through the junction box; steps must be performed in order, CMCEL1 (left fork) first, CMCEL2 (right fork) second, as viewed from the driver’s position
norñ	Normalization – Trimming of the load cells of each fork
rEZEro	Rezero Calibration – Performs a zero calibration to remove an offset value from the zero and fork calibrations created when weight lifting devices are used; See <a href="#">Section 5.3 on page 37</a>
uLin	Linear Calibration – A linear or multi-point calibration increases scale accuracy by performing up to five calibration points between zero and capacity; See <a href="#">Section 5.2.2 on page 37</a> WLINV# – Sets the test weight value for linear calibration point WLINC# – Executes the linear calibration process for the point

Table 4-6. Setup – Calibration Menu Parameter

### 4.4.4 Setup – Communication Menu

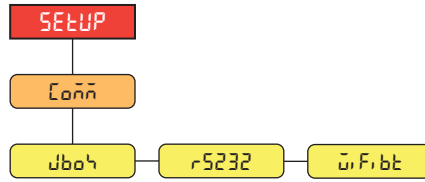

Figure 4-8. Setup – Communication Menu

Menu	Description
Jbòh	J-Box – Sets the junction box communication type; <i>Settings:</i> <b>RS232</b> (default) – Enables wired junction box communication through the M16 J-box connector on back of the enclosure <b>ZIGBEE</b> – Enables cableless option of Zigbee communication with the junction box (Section 8.0 on page 46); requires the factory paired Zigbee option
r5232	RS-232 – Serial communications RS-232 port menu; Section 4.4.4.1 on page 28
Wi, bE	WiFi / Bluetooth®– Supports WiFi and Bluetooth® communications; See Section 4.4.4.2 on page 29

Table 4-7. Setup – Communication Menu Descriptions

#### 4.4.4.1 RS-232 Port Menu

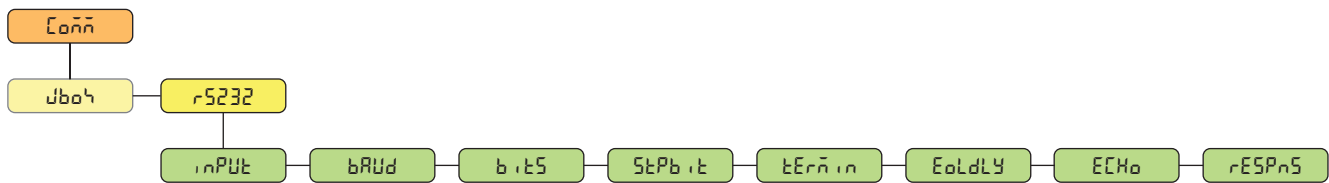

Figure 4-9. Communication – RS-232 Menu

Parameter	Description
inPÙt	Input – Sets the input trigger type; <i>Settings:</i> <b>CMD</b> (default) – Command: setting input trigger to command allows operation of EDP commands and can print <b>STRIND</b> – Stream Industrial Scale Data: data is updated up to configured sample rate; allows operation of EDP commands and printing <b>STRLFT</b> – Stream Legal for Trade Scale Data: data is updated at the configured display update rate; allows operation of EDP commands and printing
bRÙd	Baud Rate – Sets the transmission speed for the port; <i>Settings:</i> 1200, 2400, 4800, <b>9600</b> (default), 19200, 28800, 38400, 57600, 115200
b, E5	Data Bits – Sets number of data bits transmitted or received by the port and specifies the parity bit to odd, even or none; <i>Settings:</i> <b>8NONE</b> (default), <b>7EVEN</b> , <b>7ODD</b>
StPb, E	Stop Bits – Sets the number of stop bits transmitted or received by the port; <i>Settings:</i> <b>1</b> (default), <b>2</b>
tErñ, n	Outgoing Line Termination – Sets the termination character for data sent from the port; <i>Settings:</i> <b>CR/LF</b> (default), <b>CR</b>
EoLdLY	End of Line Delay – Sets the delay period from when a formatted line is terminated to the beginning of the next formatted serial output (measured in tenths of seconds); <i>Enter value:</i> 0–255, <b>0</b> (default)
E[Ho	Echo – Specifies if characters received by the port are echoed back to the sending unit; <i>Settings:</i> <b>ON</b> (default), <b>OFF</b>
rESPn5	Response – Specifies if the port transmits replies to serial commands; <i>Settings:</i> <b>ON</b> (default), <b>OFF</b>

Table 4-8. Communication – RS-232 Menu Parameters

### 4.4.4.2 WiFi and Bluetooth® Menu

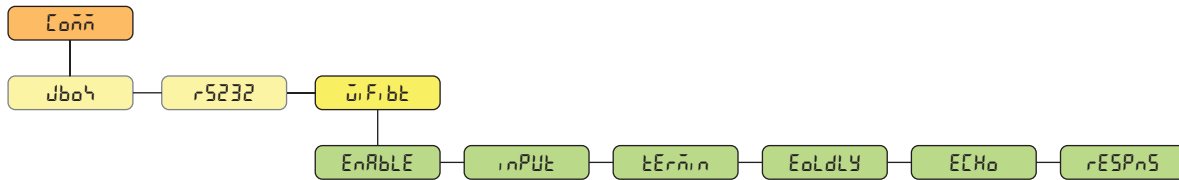

Figure 4-10. Communication – WiFi/BT Menu

Parameter	Description
ENABLE	Enable – Enables the wireless module and specifies WiFi or Bluetooth® communication LED; <i>Settings: OFF (default), WIFI, BTOOTH</i>
INPUT	Input – Sets the input trigger type; <i>Settings:</i> <b>CMD</b> (default) – Command: setting input trigger to command allows operation of EDP commands and can print <b>STRIND</b> – Stream Industrial Scale Data: data is updated up to configured sample rate; allows operation of EDP commands and printing <b>STRLFT</b> – Stream Legal for Trade Scale Data: data is updated at the configured display update rate; allows operation of EDP commands and printing
TERMIN	Outgoing Line Termination – Sets the termination character for data sent from the port; <i>Settings: CR/LF (default), CR</i>
EOLLY	End of Line Delay – Sets the delay period from when a formatted line is terminated to the beginning of the next formatted serial output (measured in milliseconds); <i>Enter value: 0–255, 0 (default)</i>
ECHO	Echo – Specifies if characters received by the port are echoed back to the sending unit; <i>Settings: ON (default), OFF</i>
RESPNS	Response – Specifies if the port transmits replies to serial commands; <i>Settings: ON (default), OFF</i>

Table 4-9. Comm – WiFi/BT Menu Parameters

### 4.4.5 Setup – Program Menu

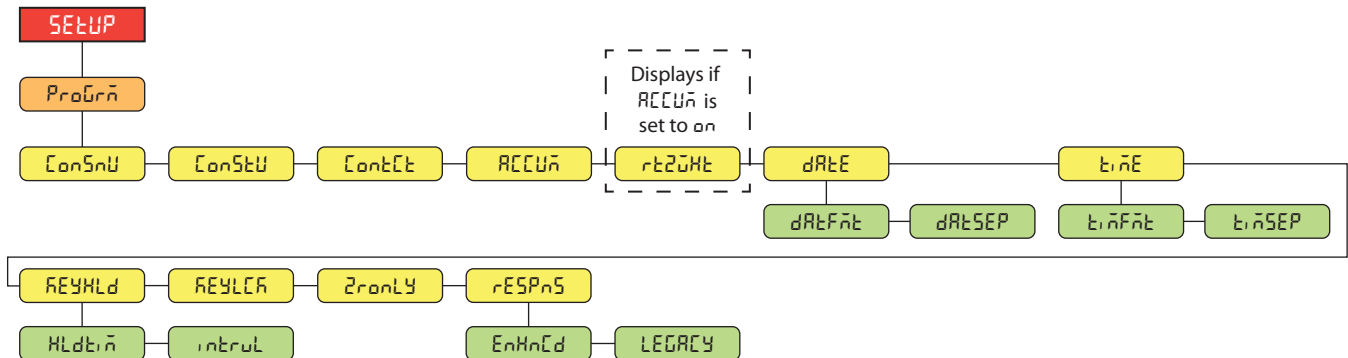

Figure 4-11. Setup – Program Menu

Parameter	Description
CONSNU	Consecutive Numbering – Allows sequential numbering for print operations; the value is incremented following each print operation which includes <CN> in the ticket format; <i>Enter value: 0–9999999, 0 (default)</i>
CONSSTV	Consecutive Number Startup Value – Specifies the initial consecutive number (CONSNU) value used when the consecutive number is reset by sending CLRNCN digital input; <i>Enter value: 0–9999999, 0 (default)</i>
CONTACT	Contact Information; See <a href="#">Section 4.4.5.1 on page 30</a>
ACCUM	Accumulator – Accumulation can be toggled ON/OFF; if ON, accumulation occurs on print operation; if OFF, an accumulation does not occur; <i>Settings: OFF (default), ON</i>
RTZWT	Return to Zero Weight – The weight (measured in primary units) from zero at which the accumulator re-arms itself; only visible if the Accumulator (ACCUM) parameter is set to On; <i>Enter value: 0.0–100.0, 2.0 (default)</i>
DATE	Date – Allows setting of the date format and date separator character; see <a href="#">Section 3.5.17 on page 23</a> to view and edit the date value <b>DATFMT</b> – Date Format; <i>Settings: MMDDYY (default), DDMMYY, YYMMDD, YYDDMM</i> <b>DATSEP</b> – Date Separator; <i>Settings: SLASH (default), DASH, SEMI, DOT</i>

Table 4-10. Setup – Program Menu Parameters



### 4.4.6 Setup – Print Format Menu

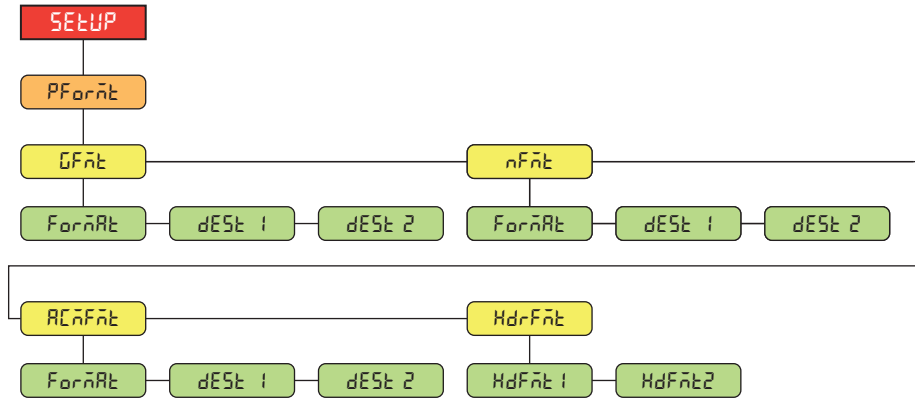

Figure 4-13. Setup – Print Format Menu

Parameter	Description
GFormat	Gross Format – Gross demand print format string FORMAT – Enter characters: Alphanumeric entry up to 1000 characters, Gross<g><n/2><td><n/ (default) DEST 1-2 – Destination ports; Settings: <b>RS232</b> (DEST 1 default), WIFIBT, NONE (DEST 2 default)
NetFormat	Net Format – Net demand print format string FORMAT – Enter characters: Alphanumeric entry up to 1000 characters, Gross<g><n/ Tare<sp><t><n/ Net<sp2><n><n/2><td><n/ (default) DEST 1-2 – Destination ports; Settings: <b>RS232</b> (DEST 1 default), WIFIBT, NONE (DEST 2 default)
AccumFormat	Accumulator Format – Accumulator print format string FORMAT – Enter characters: Alphanumeric entry up to 1000 characters, Accum <a><n/ <da> <ti><n/ (default) DEST 1-2 – Destination ports; Settings: <b>RS232</b> (DEST 1 default), WIFIBT, NONE (DEST 2 default)
HeaderFormat	Header Format – Ticket header format strings HDFMT1 – Header 1 Format String; Enter characters: Alphanumeric entry up to 1000 characters, Company Name<n/ >Street Address<n/ >City St Zip<n/2> (default) HDFMT2 – Header 2 Format String; Enter characters: Alphanumeric entry up to 1000 characters, Company Name<n/ >Street Address<n/ >City St Zip<n/2> (default)

Table 4-12. Setup – Print Format Menu Parameters

### 4.4.7 Setup – Stream Format Menu

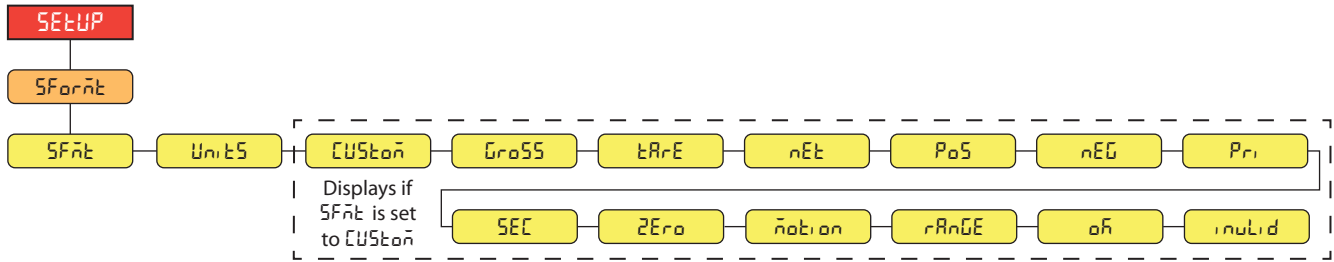

Figure 4-14. Setup – Stream Format Menu

Parameter	Description
SFMT	Stream Format – Specifies the stream format used for streaming output of scale data or specifies the expected input for a serial scale; Settings: <b>RLWS</b> (default) – Rice Lake Weighing Systems stream format (Section 11.3.1 on page 57) <b>CRDNAL</b> – Cardinal stream format (Section 11.3.2 on page 57) <b>WTRNIX</b> – Avery Weigh-Tronix stream format (Section 11.3.3 on page 58) <b>TOLEDO</b> – Mettler Toledo stream format (Section 11.3.4 on page 58) <b>CUSTOM</b> – Custom stream format
UNITS	Units – Specifies whether the streaming unit tokens remain static or dynamically updated with the configured units; Static uses set Primary/Secondary unit tokens and Dynamic defaults to configured units of the scale; Settings: <b>STATIC</b> (default), <b>DYNAMIC</b> <b>NOTE: UNITS defaults to STATIC when SFMT is set to RLWS, TOLEDO or CUSTOM, and defaults to DYNAMIC for CRDNAL and WTRNIX</b>
CUSTOM	Custom Stream Format – Specifies the custom stream format; only displays if SFMT is set to CUSTOM; Enter characters: Alphanumeric entry up to 1000 characters
GROSS	Gross – Mode token when streaming the gross weight; Enter characters: Alphanumeric entry up to 8 characters, <b>G</b> (default)
TARE	Tare – Mode token when streaming the tare weight; Enter characters: Alphanumeric entry up to 8 characters, <b>T</b> (default)
NET	Net – Mode token when streaming the net weight; Enter characters: Alphanumeric entry up to 8 characters, <b>N</b> (default)
POS	Positive – Polarity token when the weight is positive; Settings: <b>SPACE</b> (default), <b>NONE</b> , +
NEG	Negative – Polarity token when the weight is negative; Settings: <b>SPACE</b> , <b>NONE</b> , – (default)
PRI	Primary – Units token when streaming primary units; Enter characters: Alphanumeric entry up to 8 characters, <b>L</b> (default)
SEC	Secondary – Units token when streaming secondary units; Enter characters: Alphanumeric entry up to 8 characters, <b>K</b> (default)
ZERO	Zero – Status token when the weight is at center of zero; Enter characters: Alphanumeric entry up to 2 characters, <b>Z</b> (default)
MOTION	Motion – Status token when the weight is in motion; Enter characters: Alphanumeric entry up to 2 characters, <b>M</b> (default)
RANGE	Range – Status token when the weight is out of range; Enter characters: Alphanumeric entry up to 2 characters, <b>O</b> (default)
OK	OK – Status token when the weight is OK (not invalid, out of range, at zero or in motion); Enter characters: Alphanumeric entry up to 2 characters (default is a space)
INVALID	Invalid – Status token when streaming an invalid weight; Enter characters: Alphanumeric entry up to 2 characters, <b>I</b> (default)

Table 4-13. Setup – Stream Format Menu Parameters



### 4.4.8 Setup – Default Menu

See [Section 3.5.19 on page 23](#) for instructions to reset configurable CLS-680 or J-Box parameters to default settings.

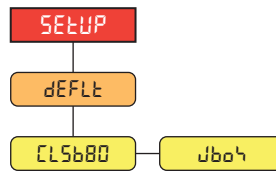

Figure 4-15. Default Menu

Parameter	Description
CLS680	CLS-680 – Defaults the CLS-680 configurable parameters without defaulting any J-Box related parameters; <i>Options: NO, YES</i>
JbOX	J-Box – Defaults the junction box (J-Box) configurable parameters, defaults MODE parameter to 100; <i>Options: NO, YES</i>

Table 4-14. Default Menu Parameters

## 4.5 Accumulator Menu

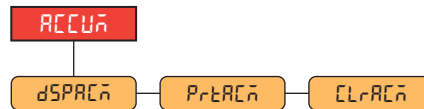

Figure 4-16. Accumulator Menu

Parameter	Description
dSPACñ	Display Accumulator – Displays the accumulator value; <i>Read Only</i>
PrtACñ	Print Accumulator – Prints the accumulator value to specified port, if setup
CLRACñ	Clear Accumulator – Clears the accumulator value

Table 4-15. Accumulator Menu Parameters

## 4.6 Tare Menu

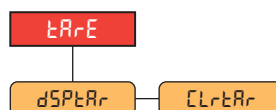

Figure 4-17. Tare Menu

Parameter	Description
dSPtAr	Display Tare – Displays the current tare value; <i>Read Only</i>
CLrtAr	Clear Tare – Clears the current tare value

Table 4-16. Tare Menu Parameters

## 4.7 MAC ID Menu

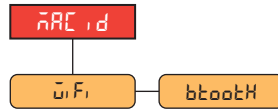

Figure 4-18. MAC ID Menu

Parameter	Description
WiFi	WiFi – Displays the WiFi MAC Address; <i>Read Only</i>
Bluetooth	Bluetooth® – Displays the Bluetooth® MAC Address; <i>Read Only</i>

Table 4-17. MAC ID Menu Parameters

## 4.8 J-Box Info Menu

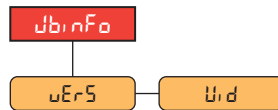

Figure 4-19. J-Box Info Menu

Parameter	Description
Version	J-Box Version – Displays the junction box firmware version number; <i>Read Only</i>
Unit ID	Unit ID – Displays the unit identification number of the junction box; <i>Read Only</i>

Table 4-18. J-Box Info Menu Parameters

## 5.0 Calibration

The forklift scale (CLS) can be calibrated using the front panel of the CLS-680 Forklift Scale Display. The following sections describe the procedures required for calibration.

**NOTE:** All weight related parameters must be configured prior to calibrating the unit (Section 4.4.1 on page 26). The entire Calibration procedure (Section 5.2.1 on page 36) is necessary for a standard calibration.

Linear calibration points are optional (Section 5.2.2 on page 37). Linear points must fall between zero and capacity.

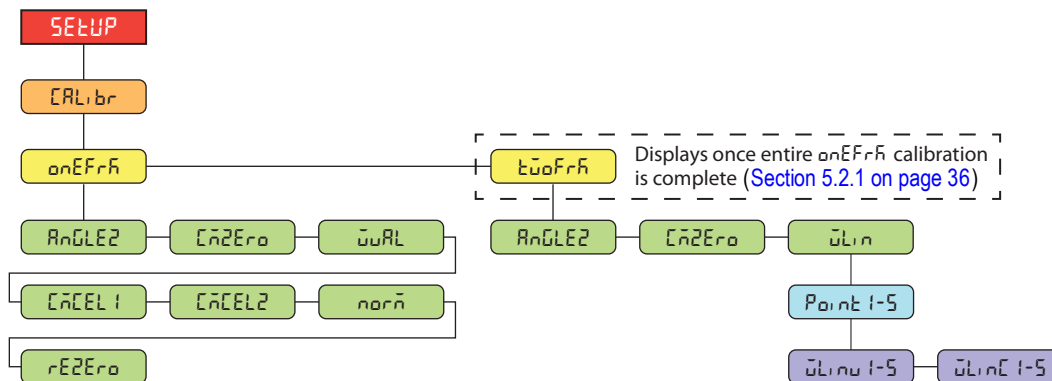

Figure 5-1. Calibration Menu

### 5.1 Calibration Preparation

Review the following important notes prior to the calibration process.

- The test weights used in a two-fork calibration cannot be greater than 5000 lb
- The test weights used in a one-fork calibration cannot be greater than 2500 lb
- A level is necessary to ensure the forklift tines are level prior to calibration
- Exercise the load cells prior to calibration by lifting weights
- Follow the calibration sequences as defined, otherwise errors will occur
- Once the calibration process has started, make sure the CLS-680 does not lose power
- In the configuration menu, check to ensure **GRADS** are set to 1000 and **ZRANGE** is set to 1.9 (%)
- Determine the test weight hanging devices needed for calibration (Section 5.1.1)

#### 5.1.1 Devices used for Lifting of Calibration Weights

There are many techniques and devices used for lifting the test weights during the calibration process. For best performance, use the following methods and devices.

##### Two Straps, Chains, Fork Sleeves with Hooks

The use of two straps (slings), chains or fork sleeves (channel) with hooks are recommended methods used to lift test weights during a calibration process. Place chosen devices on each fork before the **CMZERO** (zero calibration) step is performed in the calibration procedure. Devices used to lift the weight should be less than 20 lb each. A rezero calibration (Section 5.3 on page 37) is then performed at the end of the calibration procedure to remove the calibration offset created by these devices.

##### One Strap, Chain, Fork Sleeve with Hook

The use of a single device requires the known weight of the device to be added into the **WVAL** (weight value) entry for the calibration of each fork.

**NOTE:** The use of other apparatuses can cause an error during the calibration process. Shifting of loads between the zero and individual load cell calibration will affect the digital trimming. Do not reconfigure the dead load during the calibration process.









## 5.2 Front Panel Calibration

### 5.2.1 One-Fork Calibration















To calibrate, the forklift tines must be in place as test weights are placed upon them.

 **NOTE:** Use a level to ensure that the forklift tines are level prior to calibration. The test weight used to calibrate the individual forks cannot be greater than 2500 lb.

Do the following to calibrate the CLS-680 using the front panel:

1. Access setup mode by pressing the setup switch (Section 4.1 on page 24).  $\square \square \square \square$  displays.
2. Press  until  $\square \square \square \square$  displays.
3. Use a level to ensure the forklift tines are level. Press ,  $\square \square \square \square$  displays.
4. Press ,  $\square \square \square \square$  displays.
5. With no weight on the forklift tines, press  or  to zero the scale inclinometer.  $\square \square$  displays.
6. Press ,  $\square \square \square \square$  displays.
7. Review Section 5.1.1 on page 35 to determine the method of calibration.
8. Press  or  to perform the zero calibration.  $\square \square$  displays.

 **NOTE:** If an error occurs during calibration, an error message that begins with  $\square \square$  will appear, followed by a word or two to indicate what the problem was that occurred. See Section 11.1 on page 56 for a list of possible error messages.



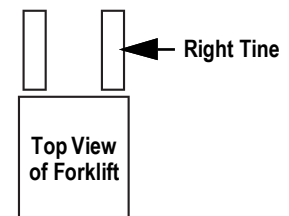













9. Press ,  $\square \square \square \square$  displays.
10. Press , the current test weight value displays. Edit the value using the numeric keypad, if needed.
11. Press , to accept the weight value.  $\square \square$  displays.
12. Press ,  $\square \square \square \square$  displays.
13. Position test weight on the right tine of the forklift (centered), allowing the test weight to stabilize.
14. Press  or  to calibrate the right tine.  $\square \square$  displays.
15. Press ,  $\square \square \square \square$  displays.
16. Move test weight to the left tine (centered), allowing the test weight to stabilize.
17. Press  or  to calibrate the left tine.  $\square \square$  displays.
18. Press ,  $\square \square \square \square$  displays.
19. Remove the test weight from the left tine of the forklift.
20. Press , to normalize the load cells of both the right and left tines.  $\square \square$  displays.
21. Press ,  $\square \square \square \square$  displays.
22. Remove test weight hanging devices, if used.
23. Press , to perform a rezero calibration (Section 5.3 on page 37).  $\square \square$  displays.
24. Press  then  to return to weigh mode.



 **NOTE:** Perform all calibration steps indicated each time the unit is calibrated. Refer to Section 4.4.3 on page 27 for calibration menu definitions.





## 5.2.2 Two-Fork Linear Calibration

Linear calibration points provide increased scale accuracy by calibrating up to five additional points between zero and capacity.

1. Access setup mode by pressing the setup switch ([Section 4.1 on page 24](#)).  $\text{CONF}$  displays.
2. Press  until  $\text{RLIB}$  displays.
3. Use a level to ensure the forklift tines are level. Press ,  $\text{GROSS}$  displays.
4. Press .  $\text{GROSS}$  displays.
5. Press .  $\text{NET}$  displays.
6. With no weight on the forklift tines, press  or  to zero the scale inclinometer.  $\text{0}$  displays.
7. Press ,  $\text{NET}$  displays.
8. Review [Section 5.1.1 on page 35](#) to determine the method of calibration.
9. Press  or  to capture the zero load.  $\text{0}$  displays.
10. Press ,  $\text{NET}$  displays.
11. Press .  $\text{NET}$  displays.
12. Press .  $\text{NET}$  displays.
13. Press . The current test weight value for the point displays. Edit the value using the numeric keypad, if needed.
14. Press  to accept the weight value.  $\text{0}$  displays.
15. Press ,  $\text{NET}$  displays.
16. Place the specified amount of test weight on forks.
17. Press  or  to perform a linear point calibration.  $\text{0}$  displays.



**NOTE:** The linear calibration for a point is saved once point is calibrated.

18. Press ,  $\text{NET}$  displays.
19. Press .  $\text{NET}$  displays.
20. Press .  $\text{NET}$  displays.
21. Repeat [steps 12-20](#) for additional linear calibration points, as needed.
22. Press  to return to weigh mode.

## 5.3 Rezero Calibration

A rezero calibration ( $\text{REZERO}$ ) is needed at the end of a one-fork calibration to remove the calibration offset created when straps (slings), chains or fork sleeves (channel) with hooks are used to lift and suspend the test weights.

Once the one-fork calibration is complete, remove test weights and the test weight hanging devices from the scale. With all the weight removed, a rezero calibration is used to adjust the zero and fork calibration values.

## 6.0 WiFi Configuration

The CLS-680 is a WiFi or Bluetooth® device. The CLS-680 creates a WiFi network that can be connected to. Configuration of the wireless settings is done through the built-in Web Manager. The Web Manager can be accessed through the built-in Soft AP (Access Point) and by default, the Soft AP is available any time the unit is powered up.

The Soft AP can be used to connect to a location's network using the Web Manager. In applications that don't have a local network to connect to or if the network is not in range, the Soft AP connection can also be used to talk to a CLS-680 by connecting to IP 192.168.0.1, port 10001.

The CLS-680 features a Lantronix® xPico 200 Series wireless module. Visit [www.lantronix.com](http://www.lantronix.com) to view the xPico 200 Series User Guide for detailed instructions on the module.



**NOTE:** The use of a web browser on a computer or phone is needed to access the wireless module's built-in Web Manager. See [Section 3.5.18 on page 23](#) to view the WiFi and Bluetooth® MAC Addresses from the front panel of the CLS-680.

### Soft AP (Access Point) Details

- Name: **RLWS\_XXXXXX**
- Password: **PASSWORD**
- Configuration Page: **http://192.168.0.1**



**NOTE:** The Soft AP only shows up as a 5 GHz network. The connecting device must be capable of using the 5 GHz band to connect to the Soft AP.

## 6.1 WiFi Setup

The following procedure is for setting up the WiFi network using the wireless module's built-in Web Manager.

1. Power on the CLS-680.



**NOTE:** The green LED on the right side of the front panel indicates if WiFi is turned on.

2. To enable the wireless module and turn on the WiFi LED in the CLS-680 menu:
  - In setup mode ([Section 4.1 on page 24](#)), navigate to SETUP→COMM→WIFIBT→ENABLE, and set to WIFI
  - Press the MENU key to return to weigh mode
3. Scan for available WiFi networks using a computer or phone and connect to the Soft AP. It might take a few attempts before the Soft AP appears on the computer or phone.
  - Soft AP Name: **RLWS\_XXXXXX**
  - Soft AP Password: **PASSWORD**



**IMPORTANT:** It is recommended to change default passwords to limit access and for security.

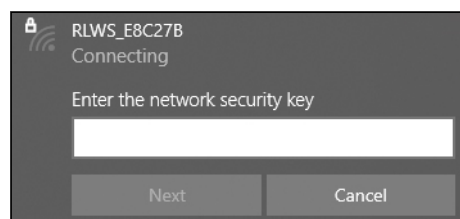

**NOTE:** The X's in the name represent the last 6 digits of the WiFi MAC address. The serial number on the wireless module's label is almost the same, other than the last digit being one number/character less than the WiFi MAC address.

For example, if the module's serial number is "0080A3E8C27A", then the SSID would be "RLWS\_E8C27B". The MAC address is a Hexadecimal value, so the letter A follows the number 9, and this continues to F before incrementing the next most significant digit and returning to 0.

The wireless module's serial number is the same as the Bluetooth® MAC address.

The WiFi and Bluetooth® MAC addresses can be found in the top-level MAC ID menu ([Section 3.5.18 on page 23](#)).

- Once connected to the Soft AP, use a web browser and enter **192.168.0.1** as the URL address and press **Enter**.

 **NOTE:** Once connected to a network, a web browser on that network can connect to the Web Manager by simply navigating to the wireless module's IP Address (available on the Status page of the Web Manager).

- Enter the default login credentials for the Web Manager.

- Username: **admin**
- Password: **PASSWORD**

 **IMPORTANT:** It is recommended to change default passwords to limit access and for security.

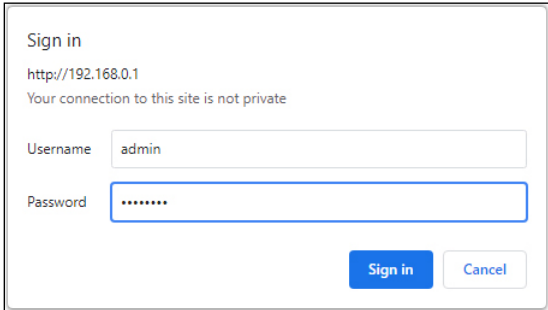

- Press **Sign in**. The Web Manager loads in the browser and the **Status** page appears.

- Click **QuickConnect** at the top of the left nav.

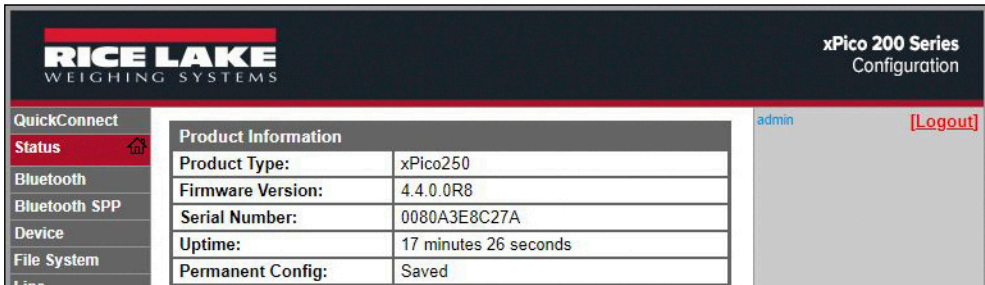

- A list of wireless networks appear. Click the network name intended to connect the wireless module's WiFi network to.

 **NOTE:** If the necessary network does not show up, just click the Scan button again. It may take a few tries to show the network. If the network is hidden, enter the network name in the box provided.

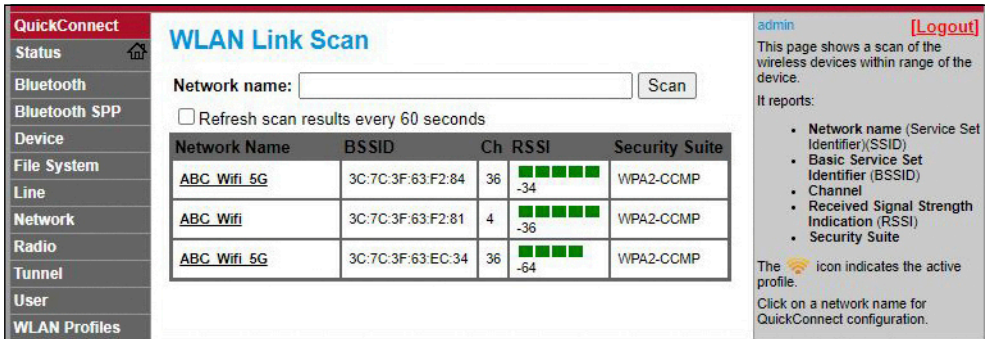

Network Name	BSSID	Ch	RSSI	Security Suite
ABC Wifi 5G	3C:7C:3F:63:F2:84	36	-34	WPA2-CCMP
ABC Wifi	3C:7C:3F:63:F2:81	4	-36	WPA2-CCMP
ABC Wifi 5G	3C:7C:3F:63:EC:34	36	-64	WPA2-CCMP

 **NOTE:** The Web Manager provides notes and information related to the current page in the far right column. Descriptions for options and settings are also provide when hovering over the item in question.



9. The wireless network information page appears. Enter the network password (if applicable).

 **NOTE: Contact location's IT administrator to obtain network credentials as needed based on the security that is in place.**

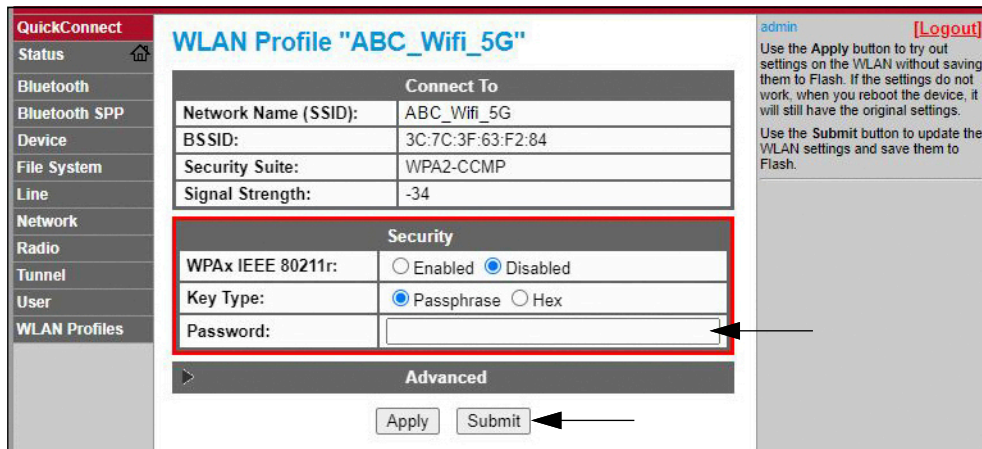

10. Click **Submit** to apply and save the settings. A message displays at the top of the page to show if the new network's Profile saved successfully. It does not necessarily mean it is connected to the network.

 **NOTE: The Apply button only applies the settings for the current session, but does NOT save them.**

11. To verify that the wireless module is connected to the location's network, click **Status** near the top of the left nav.

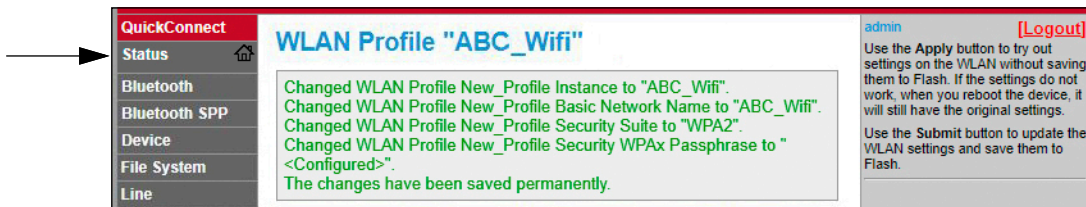

12. The **Status** page shows all of the network connections on the device under **Network Settings**.

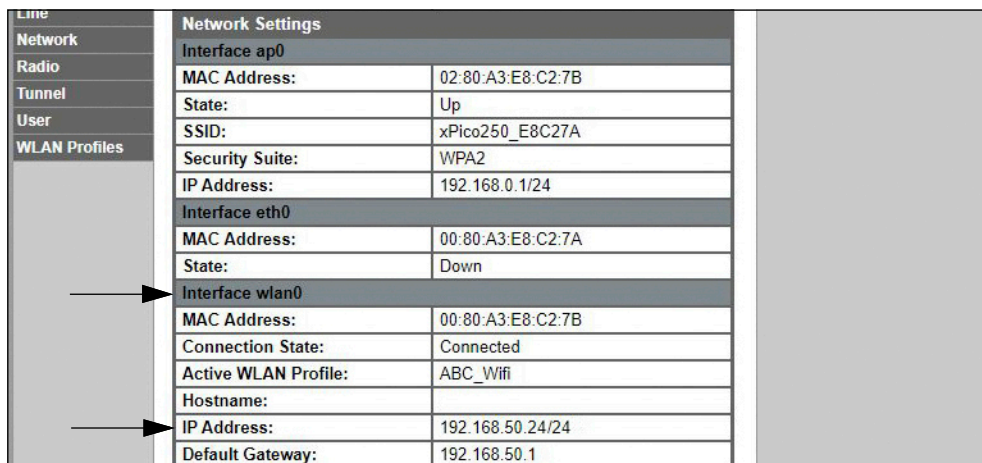

- If Connected: Interface wlan0 is listed with **Connection State** showing **Connected** and the **IP Address** populated.

 **NOTE: The "/24" at the end of the IP Address indicates the number of bits set for the network subnet mask and is not part of the IP Address itself. There are 32 bits in a subnet mask and "/24" indicates the subnet mask is 255.255.255.0.**

- If Not Connected: First try refreshing the browser to see if the information populates, then click **WLAN Profiles** at the bottom of the left nav to change the network settings and try again.



13. Connecting to the wireless module's server with a remote client is now possible.
14. Using a Terminal Emulation program, such as Putty, as a remote client connection to the wireless module's server over Telnet is possible using the IP Address that was noted in [Step 12 on page 40](#) and the Local Port number, which by default is 10001.

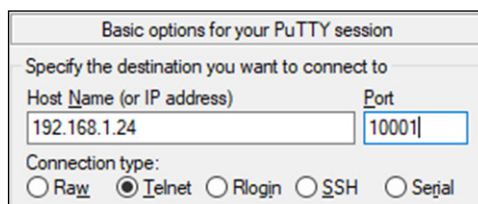

Figure 6-1. Putty Example



**NOTE:** If the card's IP address changed and there is no longer access to the card through the location's wireless network, connect to the Soft AP and use the Web Manager to learn the new IP Address.

For more information on all the features of this card, visit [www.lantronix.com](http://www.lantronix.com) to view the xPico 200 Series User Guide.

## 6.2 Wireless Module Specifications

The CLS-680 features a Lantronix® xPico 200 Series wireless module. Visit [www.lantronix.com](http://www.lantronix.com) to view the latest list of technical specifications on the wireless module.

### Wireless Specifications

- IEEE 802.11 a/b/g up to 54 Mbps; 802.11 n (1×1) up to 150 Mbps
- 20 and 40 MHz channel width with optional SGI
- Dual Band 2.4 GHz and 5 GHz, Channels 1-13, UNII-1, 2a, 2e and 3
- Supports IEEE 802.11 d/h/i
- Bluetooth®/WLAN Coexistence
- 802.11r fast roaming

### Data Communication

- TruPort® Serial Technology— TCP and UDP Server Mode, TCP and UDP Client Mode, Multi-host Connect; TLS Client and Server
- TruPort® Socket— Multi-host Client and Server Modes, HTTP(S), Sockets, TLS
- Authenticated SMTP Support— Send email directly from device

### Security and Authentication

- TruPort® Security Software
  - Secure Boot, Secure Firmware-Over-the-Air (FOTA) Updates
  - Secure Key Storage, Encrypted Configuration
  - Secure Connections with SSL/TLS, HTTPS
  - Software Controlled Network Service Ports Enable/Disable
  - Role Based Access Control
- AES/CCMP and TKIP encryption, WPA/WPA2 Personal
- WPA2 Enterprise (EAP-TLS, EAP-TTLS, EAP-PEAP, EAP-FAST)
- SSLv3/TLS 1.2 with PKI and X.509 Certificates (up to 4096-bit Keys)
- AES Algorithm, 256-bit, 192-bit, 128-bit

### Management Interfaces

- Lantronix ConsoleFlow™ Cloud Software Platform, REST, MQTT
- Lantronix Discovery Protocol (77FE)
- Serial Port, Internal Web Server (HTTP/HTTPS)
- XML Configuration and XML Status (CLI, API)
- Secure Firmware Upgrade via HTTPS, ConsoleFlow™

## Wireless Module Specifications Continued

### Protocol Support

- DHCP Client, Server (Soft AP), HTTP Server/Client
- IPv4, TCP/IP, UDP/IP, ARP, ICMP, Auto-IP, DNS
- SNMP v1/v2
- IPv6

### Wireless Features

- Concurrent Soft AP + STA (Client), Client, Soft AP
- Up to 5 simultaneous client connections to Soft AP interface
- Up to 4 in Concurrent Mode
- Connect to multiple WLAN networks, WLAN QuickConnect

### Certifications & Compliance

- Type Approvals: USA (FCC Part 15), Canada (IC RSS), EU (RED), Japan (MIC), China (SRRC), AU/NZS
- Safety: IEC 62368 EN 62368, EN 62311, UL 60950
- RoHS, REACH
- FCC ID: R68XPICO200
- CMIIT ID: 2017AJ6663(M)

## 7.0 Bluetooth® Configuration

The CLS-680 is a WiFi or Bluetooth® device. Configuration of the wireless settings is done through the built-in Web Manager. The Web Manager can be accessed through the built-in Soft AP (Access Point) and by default, the Soft AP is available any time the unit is powered up. The Soft AP connection can also be used to talk to a CLS-680 by connecting to IP 192.168.0.1, port 10001.

The CLS-680 wireless module, by default, has the connected antenna set for WiFi communications. The antenna radio setting must be changed to Bluetooth® in order to use the Bluetooth® communications feature of the wireless module.



**NOTE:** Even with the antenna set to Bluetooth®, it is still possible to scan for available WiFi networks using a computer or phone and connect to the Soft AP to access the wireless module's Web Manager.

The CLS-680 features a Lantronix® xPico 200 Series wireless module. Visit [www.lantronix.com](http://www.lantronix.com) to view the xPico 200 Series User Guide for detailed instructions on the module.



**NOTE:** The use of a web browser on a computer or phone is needed to access the wireless module's built-in Web Manager. See [Section 3.5.18 on page 23](#) to view the WiFi and Bluetooth® MAC Addresses from the front panel of the CLS-680.

### 7.1 Bluetooth® Setup

The following procedure is for setting the antenna to Bluetooth® communications using the wireless module's built-in Web Manager and then pairing to a Bluetooth® device.

1. Power on the CLS-680.



**NOTE:** The blue LED on the right side of the front panel indicates if Bluetooth® is turned on.

2. To enable the wireless module and turn on the Bluetooth® LED in the CLS-680 menu:
  - In setup mode ([Section 4.1 on page 24](#)), navigate to SETUP→COMM→WIFIBT→ENABLE, and set to BTOOTH
  - Press the MENU key to return to weigh mode
3. Scan for available WiFi networks using a computer or phone and connect to the Soft AP. It might take a few attempts before the Soft AP appears on the computer or phone. The Soft AP only shows up as a 5 GHz network.
  - Soft AP Name: **RLWS\_XXXXXX**
  - Soft AP Password: **PASSWORD**



**IMPORTANT:** It is recommended to change default passwords to limit access and for security.

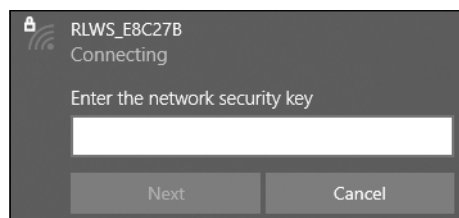

**NOTE:** The X's in the name represent the last 6 digits of the WiFi MAC address. The serial number on the wireless module's label is almost the same, other than the last digit being one number/character less than the WiFi MAC address.

For example, if the wireless module's SSID is "RLWS\_E8C27B", then the Bluetooth® MAC address would be "0080A3E8C27A". The MAC address is a Hexadecimal value, so the letter A follows the number 9, and this continues to F before incrementing the next most significant digit and returning to 0.

The wireless module's serial number is the same as the Bluetooth® MAC address.

The WiFi and Bluetooth® MAC addresses can be found in the top-level MAC ID menu ([Section 3.5.18 on page 23](#)).

4. Once connected to the Soft AP, use a web browser and enter **192.168.0.1** as the URL address and press **Enter**.
5. Enter the default login credentials for the Web Manager.
  - Username: **admin**
  - Password: **PASSWORD**

 **IMPORTANT:** It is recommended to change default passwords to limit access and for security.

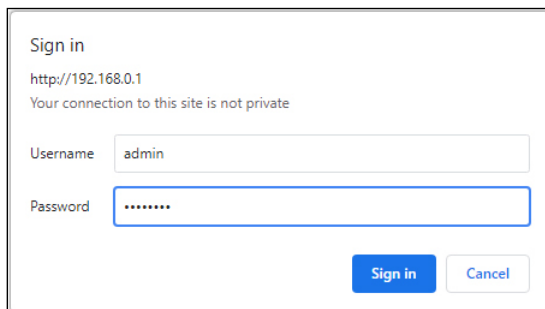

6. Press **Sign in**. The Web Manager loads in the browser and the **Status** page appears.
7. Click **Radio** in the left nav.

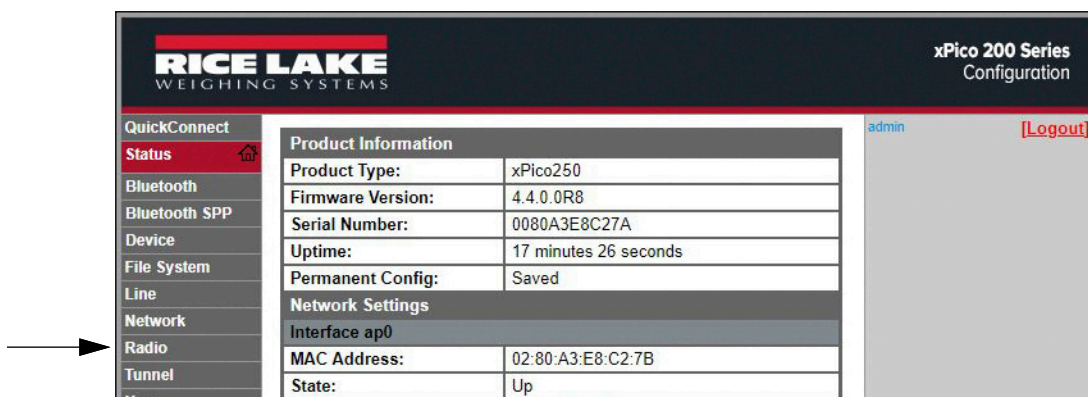

8. Click **Configuration** at the top of the **Radio Status** page.

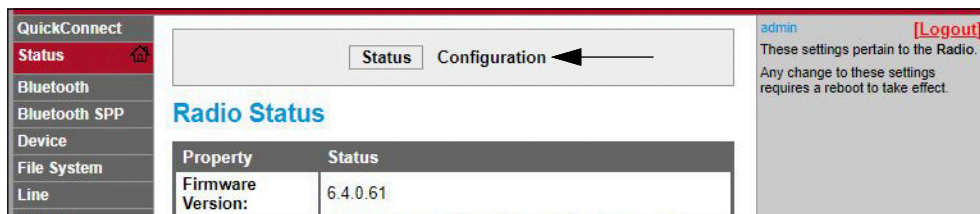

9. Change the **Antenna 1 Supports** drop-down option to **Bluetooth®**.

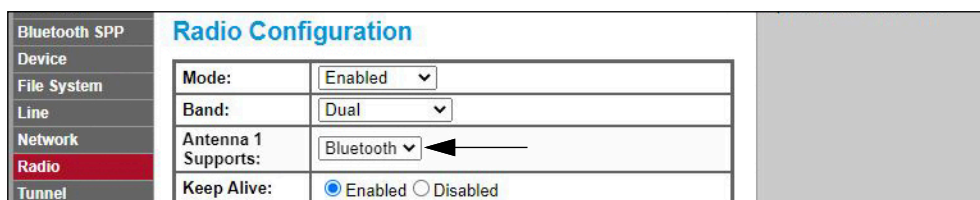

10. Click **Submit** to apply and save the settings. A message displays at the top of the page to warn that the new radio settings won't take effect until after the next reboot.

Radio Configuration	
<p>Changed Radio Antenna 1 Supports to "Bluetooth". The changes have been saved permanently. <b>WARNING: Change in Radio settings will take effect on the next reboot.</b></p>	
Mode:	Enabled ▾
Band:	Dual ▾
Antenna 1 Supports:	Bluetooth ▾

11. Use the red power button on the back of the CLS-680 to power down and then power back up the unit.
12. Scan for available Bluetooth® devices on the device that is intended to be paired with the CLS-680. The CLS-680 wireless module's Bluetooth® device name is **RLWS\_XXXXXXXXXXXX**.



**NOTE:** The X's in the name represent the entire Bluetooth® MAC address.

The Bluetooth® MAC address can be found in the top-level MAC ID menu, under BTOOTH (Section 3.5.18 on page 23).

13. Pair the intended Bluetooth® device with the CLS-680 wireless module's Bluetooth® connection.

## 7.2 Bluetooth® Specifications

The CLS-680 features a Lantronix® xPico 200 Series wireless module. Visit [www.lantronix.com](http://www.lantronix.com) to view the latest list of technical specifications on the wireless module.

- Compliant to Bluetooth® Core Specification version 4.2 (BR/EDR/Bluetooth® LE)
- Bluetooth® LE Central and Peripheral Roles
- Support for Generic Access Profile (GAP), Generic Attribute Profile (GATT), Device ID Profile
- Serial Port Profile (SPP)



**NOTE:** See Section 6.2 on page 41 for the general wireless module specifications.

## 8.0 Cableless Option

The cableless option features Zigbee modules that allow for cableless communication between the CLS-680 and the junction box. This option can be factory installed upon request when ordering or can be purchased separately and installed on site. This section describes how to install the Zigbee module into a CLS-680 for the cableless option when purchasing separately.

The cableless option includes a battery box assembly with an installed Zigbee module and a second Zigbee module that is already paired to install in the CLS-680. Lithium-Ion batteries and a charger are also included. It is recommended to have a second battery available to avoid any downtime. See the CLS-Series Service Manual (PN 96314) for additional details and specifications on batteries and charging.

**NOTE:** Within the COMM menu (Section 4.4.4 on page 28), the JBOX parameter must be set to ZIGBEE to enable cableless communication between the CLS-680 and the junction box.

### 8.1 Zigbee Module Installation

The following procedure is for the installation and setup of the Zigbee module into a CLS-680.

1. Power off the CLS-680 and open the enclosure (Section 2.4 on page 12).
2. Carefully align the Zigbee module with the J3 and J4 connectors on the CLS-680 CPU board.

**NOTE:** The Zigbee module must be aligned so the module shape matches the screen print shape around J3 and J4.

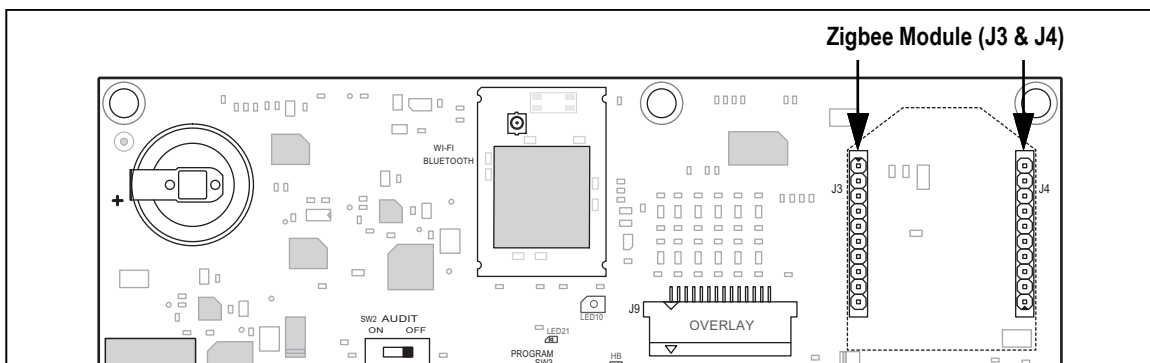

Figure 8-1. Zigbee Module Connection Location

3. Press down on the Zigbee module until it is seated onto the CPU board.

**NOTE:** No need to attach an antenna, the Zigbee module has a built-in chip antenna.

4. Close the enclosure (Section 2.4.1 on page 12).
5. In setup mode (Section 4.1 on page 24), navigate to SETUP→COMM→JBOX, and set to ZIGBEE.

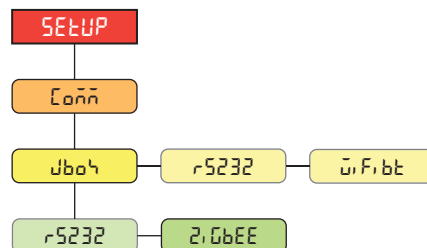

Figure 8-2. JBOX Parameter Menu Location

**NOTE:** The JBOX parameter RS232 option is for a wired junction box connection and changing to ZIGBEE option changes to the cableless junction box connection.

6. Press the MENU key to return to weigh mode.

## 9.0 EDP Commands

The CLS-680 Forklift Scale Display can be controlled by a personal computer connected to one of the communication ports. Control is provided by a set of commands which can simulate front panel key press functions, return and change setup parameters, and perform reporting functions. The commands provide the capability to print configuration data or to save data to an attached personal computer. This section describes the EDP command set and procedures for saving and transferring data using the communication ports. The EDP command set is divided into several groups.

When the CLS-680 processes a command, it either responds with a value (for reporting commands, or when querying parameter settings), or with the message **OK**. The **OK** response verifies the command was received and has been executed. If the command is unrecognized, the CLS-680 responds with **?? invalid command**. If the command cannot be executed in the current mode, the CLS-680 responds with **?? invalid mode**. If the command is recognized, but the value is out of range or the invalid type, the CLS-680 responds with **??** followed by the type and the range.

### 9.1 Key Press Commands

Key press serial commands simulate pressing keys on the front panel of the CLS-680. These commands can be used in both setup and weigh mode. Several of the commands serve as pseudo keys, providing functions which are not represented by a key on the front panel.

For example, to enter a 15 lb tare weight using serial commands:

1. Type **K1** and press **Enter** (or **Return**).
2. Type **K5** and press **Enter**.
3. Type **KTARE** and press **Enter**.

Command	Function
KZERO	In weigh mode, this command acts like pressing the <b>Zero</b> key
KGROSSNET	In weigh mode, this command acts like pressing the <b>Gross/Net</b> key
KGROSS	Displays Gross mode (pseudo key)
KNET	Displays Net mode (pseudo key)
KTARE	In weigh mode, this command acts like pressing the <b>Tare</b> key
KUNITS	In weigh mode, this command acts like pressing the <b>Units</b> key
KMENU	This command acts like pressing the <b>Menu</b> key
KPRIM	Displays primary units (pseudo key)
KSEC	Displays secondary units (pseudo key)
KPRINT	In weigh mode, this command acts like pressing the <b>Print</b> key
KDISPACCUM	Displays the accumulator value
KPRINTACCUM	Prints the accumulated weight
KCLRACCUM	Clears the accumulator
KDISPTARE	Displays the tare value
KCLRTAR	Clears the tare from the system (pseudo key)
KCLR	In weigh mode, this command acts like pressing the <b>Clear</b> key
KCLRCN	Clears consecutive number
KLEFT	In setup mode, this command moves <b>Left</b> in the menu
KRIGHT	In setup mode, this command moves <b>Right</b> in the menu
KUP	In setup mode, this command moves <b>Up</b> in the menu
KDOWN	In setup mode, this command moves <b>Down</b> in the menu
KENTER	This command acts like pressing the <b>Enter</b> key
KEXIT	In setup mode, this command exits to weigh mode
KSAVE	In setup mode, this command saves the current configuration
KSAVEEXIT	In setup mode, this command saves the current configuration and exits to weigh mode
KTIME	Returns the time

Table 9-1. Key Press Commands



Command	Function
KDATE	Returns the date
KTIMEDATE	Returns the time and date
Kn	This command acts like pressing numbers 0 (zero) through 9
KDOT	This command acts like pressing the decimal point (.)
KLOCK=x	In setup mode, this command locks specified front panel key; x = KPRINT, KUNITS, KTARE, KGROSSNET, KZERO, K0-K9, KDOT, KCLEAR (example: to lock the <b>Z</b> ero key, enter KLOCK=KZERO)
KUNLOCK=x	In setup mode, this command unlocks specified front panel key; x = KPRINT, KUNITS, KTARE, KGROSSNET, KZERO, K0-K9, KDOT, KCLEAR (example: to unlock the <b>P</b> rint key, enter KUNLOCK=KPRINT)

Table 9-1. Key Press Commands (Continued)

## 9.2 Reporting Commands

Reporting commands send specific information to the communications port. The commands listed in Table 9-2 can be used in either setup mode or weigh mode.

Command	Function
DUMPALL	Returns a list of all parameter values
DUMPAUDIT	Returns the Audit Trail information
KDUMPAUDIT	Returns the Audit Trail information on the same port which the EDP command was sent
AUDIT.LRVERSION	Returns the legally relevant firmware version
AUDIT.CONFIG	Returns the number of times configuration has changed
AUDIT.CALIBRATE	Returns the number of calibrations
AUDITJUMPER	Returns the position of the audit jumper (ON or OFF)
VERSION	Returns the firmware version of the CLS-680
JB_VERSION	Returns the firmware version of the J-box
HWSUPPORT	Returns the CPU board part number
RTCBATTERYSTATUS	Returns the status of the real time clock battery (GOOD or BAD)

Table 9-2. Reporting Commands

## 9.3 Reset Configuration Command

The following command can be used to reset the configuration parameters of the CLS-680.

Command	Function
RESETCONFIGURATION	Restores the CLS-680 configurable parameters to default values (setup mode only)
JB_RESETCONFIGURATION	Restores the J-Box configurable parameters to default values (setup mode only)

Table 9-3. Reset Configuration Command



**NOTE:** All scale calibration settings are lost when the **RESETCONFIGURATION** command is run.



## 9.4 Parameter Setting Commands

Parameter setting commands allow the current value for a configuration parameter to be displayed or changed. Current configuration parameter settings can be displayed in setup mode or weigh mode using the following syntax:  
command<ENTER>

Configuration parameter values can only be changed in setup mode.

Use the following command syntax when changing parameter values: command=value<ENTER>, where **value** is either a number or a parameter value. Use no spaces before or after the equal (=) sign. If an incorrect command is typed or an invalid value is specified, the CLS-680 returns ?? followed by the error message.

*Example: to set the SC.ACCUM parameter on Scale #1 to ON, type the following:*

**SC.ACCUM#1=ON<ENTER>**

To return a list of the available values for parameters with specific values, enter the command and equal sign, followed by a questions mark (*command=?<ENTER>*). The CLS-680 must be in setup mode to use this function.

After changes are made to configuration parameters using EDP commands, use the **KSAVE** or **KSAVEEXIT** commands to commit the changes to memory.

Command	Description	Values
MODE	Sets the user mode (one-step configuration setting)	600–611, <b>600</b> (default)
MODELOCK	Sets which configured mode is used; when set to OFF, the configured mode is based on the J-box's mode and when set to ON, the configured mode is base on the CLS-680's mode	<b>OFF</b> (default), ON
SC.TAREFN#n	Tare function	<b>BOTH</b> (default), KEYED, NOTARE, PBTARE
SC.ACCUM#n	Accumulator enable	<b>OFF</b> (default), ON
SC.RTZWEIGHT#n	Sets the weight at which the accumulator re-arms itself	0.0–100.0, <b>2.0</b> (default)
SC1.GRADS	Sets the number of graduations	1–100000, <b>1000</b> (default)
SC1.ZRANGE	Sets the percentage of capacity the sale can be zeroed ( $\pm$ )	0.0–100.0, <b>1.9</b> (default)
SC1.PRI.DECPNT	Sets decimal point for the primary display weight format	<b>888888</b> (default), 88888.8, 8888.88, 888.888, 88.8888, 8.88888, 888800, 888880
SC1.PRI.DSPDIV	Sets display divisions for the primary display weight format	<b>5d</b> (default), 1d, 2d
SC1.PRI.UNITS	Sets units type for the primary display weight format	<b>LB</b> (default), KG, TN, T, OZ, G, NONE
SC1.SEC.DECPNT	Sets decimal point for the secondary display weight format	<b>888888</b> (default), 88888.8, 8888.88, 888.888, 88.8888, 8.88888, 888800, 888880
SC1.SEC.DSPDIV	Sets display divisions for the secondary display weight format	<b>2d</b> (default), 5d, 1d
SC1.SEC.UNITS	Sets units type for the secondary display weight format	<b>KG</b> (default), TN, T, OZ, G, NONE, LB
ANGLEZERO	Executes a pitch and roll angles zero calibration	–
SC1.CAL0	Executes a cal-match zero calibration	–
SC1.WVAL	Sets the test weight value	0.00001–5000.0, <b>1000.0</b> (default)
SC1.CAL1 - SC1.CAL2	Executes a cal-match load cell 1-2 calibration	–
SC1.NORM	Executes normalization trimming of the load cells of each fork	–
SC1.REZERO	Executes a rezero calibration	–
SC1.WLIN.V1-V5	Sets the test weight value for linear calibration point	-999999.0–999999.0, <b>0</b> (default)
SC1.WLIN.C1-C5	Executes the linear calibration process for the point	–

For commands ending with #n, n is the scale number (1)

Table 9-4. Scales Commands

## 9.5 Wireless Setting Commands

Command	Description	Values
WIFIBT.ENABLED	Enables the wireless module and specifies WiFi or Bluetooth® LED	OFF (default), WIFI, BLUETOOTH
WIFIBT.INPUT	Sets the WiFi/Bluetooth® input trigger type	CMD (default), STRIND, STRLFT
WIFIBT.TERMIN	Sets the WiFi/Bluetooth® termination character for data sent from the port	CR/LF (default), CR
WIFIBT.EOLDLY	Sets the WiFi/Bluetooth® end-of-line delay period	0–255 (0.1-second intervals), 0 (default)
WIFIBT.ECHO	Specifies if the WiFi/Bluetooth® characters received are echoed back	ON (default), OFF
WIFIBT.RESPONSE	Specifies if the WiFi/Bluetooth® port transmits replies to serial commands	ON (default), OFF
WIFI.MACID	Returns the WiFi MAC ID	–
BLUETOOTH.MACID	Returns the Bluetooth® MAC ID	–

Table 9-5. WiFi and Bluetooth® Commands

## 9.6 Serial Port Setting Commands

Command	Description	Values
JBOX.PORT	Junction box communication type	RS232 (default), ZIGBEE
EDP.INPUT#p	Port serial input function	CMD (default), STRIND, STRLFT
EDP.BAUD#p	Port baud rate	1200, 2400, 4800, 9600 (default), 19200, 38400, 57600, 115200
EDP.BITS#p	Port data bits/parity	8NONE (default), 7EVEN, 7ODD
EDP.STOPBITS#p	Port stop bits	1 (default), 2
EDP.TERMIN#p	Port line termination character	CR/LF (default), CR
EDP.EOLDLY#p	Port end-of-line delay	0–255 (0.1-second intervals), 0 (default)
EDP.ECHO#p	Port echo	ON (default), OFF
EDP.RESPONSE#p	Port response	ON (default), OFF

For commands ending with #p, p is the port number (1), 1 is RS232

Table 9-6. Serial Port Commands

## 9.7 Stream Setting Commands

Command	Description	Values
STRM.FORMAT#n	Stream format	RLWS (default), CARDNAL, WTRONIX, TOLEDO, CUSTOM
STRM.UNITS#n	Static uses EDP set Primary/Secondary units token; Dynamic defaults to configured units of the scale	STATIC (default), DYNAMIC
STRM.CUSTOM#n	Custom stream definition	Up to 1000 alphanumeric characters
STRM.GROSS#n	Mode token when streaming the Gross weight	Up to 8 alphanumeric characters, G (default)
STRM.TARE#n	Mode token when streaming the tare weight	Up to 8 alphanumeric characters, T (default)
STRM.NET#n	Mode token when streaming the Net weight	Up to 8 alphanumeric characters, N (default)
STRM.POS#n	Polarity token when the weight is positive	SPACE (default), NONE, +
STRM.NEG#n	Polarity token when the weight is negative	SPACE, NONE, – (default)
STRM.PRI#n	Units token when streaming Primary units	Up to 8 alphanumeric characters, L (default)
STRM.SEC#n	Units token when streaming Secondary units	Up to 8 alphanumeric characters, K (default)
STRM.ZERO#n	Status token when the weight is at Center of Zero	Up to 2 alphanumeric characters, Z (default)
STRM.MOTION#n	Status token when the weight is in motion	Up to 2 alphanumeric characters, M (default)
STRM.RANGE#n	Status token when the weight is Out of Range	Up to 2 alphanumeric characters, O (default)
STRM.OK#n	Status token when the weight is OK (not invalid, out of range, at zero, or in motion)	Up to 2 alphanumeric characters (default is a space)
STRM.INVALID#n	Status token when streaming an Invalid weight	Up to 2 alphanumeric characters, I (default)

For commands ending with #n, n is the stream format number (1)

Table 9-7. Stream Formatting Commands

## 9.8 Program Commands

Command	Description	Values
DATEFMT	Date format	MMDDYY (default), DDMMYY, YYMMDD, YYDDMM
DATESEP	Date separator	SLASH (default), DASH, SEMI, DOT
TIMEFMT	Time format	12HOUR (default), 24HOUR
TIMESEP	Time separator	COLON (default), COMMA, DOT
CONSNUM	Consecutive numbering	0–9999999, 0 (default)
CONSTUP	Consecutive number start-up value	0–9999999, 0 (default)
UID	Unit ID of the junction box	0–999999, 1 (default)
KYBDLK	Keyboard lock (disable keypad)	OFF (default), ON
ZERONLY	Disable all keys except ZERO	OFF (default), ON
CONTACT.COMPANY	Contact company name	Up to 30 alphanumeric characters
CONTACT.ADDR1-3	Contact company address	Up to 20 alphanumeric characters (for each line)
CONTACT.NAME1-3	Contact names	Up to 30 alphanumeric characters (for each line)
CONTACT.PHONE1-3	Contact phone numbers	Up to 20 alphanumeric characters (for each line)
CONTACT.EMAIL	Contact email address	Up to 40 alphanumeric characters
CONTACT.LASTCAL	Last calibration date	Date MMDDYYYY as an 8-digit number
CONTACT.NEXTCAL	Next calibration date	Date MMDDYYYY as an 8-digit number
KHOLDTIME	Key hold time (in tenths of a second); 20 equals 2 seconds	10–50, 20 (default)
KHOLDINTERVAL	Key hold time interval; the amount of time between increments during a key hold (in twentieths of a second); 2 equals a tenth of a second (10 increments per second during a key hold)	1–100, 2 (default)
RESPONSE.MODE	Specifies the type of responses for serial command errors	ENHANCED (default), LEGACY

Table 9-8. Program Commands

## 9.9 Print Format Commands

Command	Description	Values
GFMT GFMT.PORT GFMT.PORT2	Gross demand print format string	Each format can be sent out one or two ports; for the .PORT and .PORT2 commands, specify the port name as one of the following: RS232, WIFIBT, NONE
NFMT NFMT.PORT NFMT.PORT2	Net demand print format string	Example: To send the Gross format out the RS232 and WIFIBT ports at the same time, send: GFMT.PORT=RS232 GFMT.PORT2=WIFIBT
ACCFMT ACC.PORT ACC.PORT2	Accumulator print format string	See <a href="#">Section 10.0 on page 53</a> for information about demand print format strings
HDRFMT1 HDRFMT2	Ticket header format strings	
AUD.PORT AUD.PORT2	Audit trail port	

Table 9-9. Print Format Commands

## 9.10 Weigh Mode Commands

These commands function in the weigh mode. Non weight related commands work in setup mode.

Command	Description	Values
P	Returns what the CLS-680 is currently displaying	--
ZZ	Returns current display with annunciators	See <a href="#">Section 11.2 on page 56</a>
S	Returns a single stream frame from scale <i>n</i> using the configured stream format	--
CONSNUM	Returns current consecutive number value	0–9999999, <b>0</b> (default)
UID	Sets the unit ID of the junction box	0–999999, <b>1</b> (default)
SD	Sets or returns the current system date	MMDDYY, DDMMYY, YYMMDD, or YYDDMM. Enter six-digit date using the year-month-day order specified for the DATFMT parameter, using only the last two digits of the year; The current system date is returned by only sending SD
ST	Sets or returns the current system time	HHMM (enter using 24-hour format) The current system time is returned by only sending ST
STS	Sets or returns the current system time with seconds	HHMMSS (enter using 24-hour format) The current system time is returned by only sending STS
RS	Resets system	Soft reset; Used to reset the CLS-680 without resetting the configuration to the factory defaults
SX	Starts all serial data streams	--
EX	Stops all serial data streams	--
SX# <i>p</i>	Starts serial data stream for port <i>p</i>	OK or ??
EX# <i>p</i>	Stops serial data stream for port <i>p</i>	An EX command sent while in setup mode does not take effect until the CLS-680 is returned to weigh mode
SF# <i>n</i>	Returns a single stream frame from scale <i>n</i> using the configured stream format	--
XA# <i>n</i>	Returns the accumulator value in displayed units	nnnnnnnn UU
XG# <i>n</i>	Returns the gross weight in displayed units	nnnnnnnn UU
XN# <i>n</i>	Returns the net weight in displayed units	nnnnnnnn UU
XT# <i>n</i>	Returns the tare weight in displayed units	nnnnnnnn UU
For commands ending with # <i>n</i> , <i>n</i> is the scale number (1); For commands ending with # <i>p</i> , <i>p</i> is the port number (1), 1 is RS232		

Table 9-10. Weigh Mode Commands

## 10.0 Print Formatting

The CLS-680 provides multiple print formats, GFMT, NFMT, ACMFMT and HDRFMT, which determine the format of the printed output when the **Print** key is pressed. If a tare has been entered or acquired, NFMT is used; otherwise, GFMT is used.

Each print format can be customized to include up to 1000 characters of information, such as company name and address, on printed tickets. Use the print format menu through front panel of the CLS-680 to customize the print formats.



**NOTE:** Press the down arrow to view the ASCII character decimal value on the second menu level. See [Section 11.5 on page 61](#) to view the ASCII character chart.

### 10.1 Print Formatting Tokens

[Table 10-1](#) lists tokens which can be used to configure the print formats. Tokens included in the format strings must be enclosed between < and > delimiters. Characters outside of the delimiters are printed as text on the ticket. Text characters can include ASCII characters which can be printed by the output device.

Token	Description	Supported Ticket Formats
<i>General Weight Data Tokens</i>		
<Gx>	Gross weight, current scale	GFMT, NFMT, ACMFMT
<Gx#n>	Gross weight, scale <i>n</i>	
<Nx>	Net weight, current scale	
<Nx#n>	Net weight, scale <i>n</i>	
<Tx>	Tare weight, current scale	
<Tx#n>	Tare weight, scale <i>n</i>	
<S>	Current scale number	
<p><b>NOTE:</b> For tokens with #<i>n</i>, <i>n</i> is the scale number (1). For tokens with an <i>x</i>, <i>x</i> is the character width of the weight field with padded spaces on the left. If <i>x</i> is not specified, 10 is the assumed default for the weight field. <i>x</i> can be set using one or two digits and sets the minimum number of characters in the weight field, but expands to show all characters for a value that has more characters than the minimum value set with <i>x</i>.</p> <p>Example: To format a ticket to provide gross weight for Scale 1 with a minimum of 6 print characters, use the following token: &lt;G6#1&gt;</p> <p><b>NOTE:</b> Gross, net and tare weights are printed with the currently displayed weight unit. The displayed unit modifier (/D) can be added to the gross, net, and tare weight tokens, or if not specified, the currently displayed unit (/D) is assumed.</p> <p><b>NOTE:</b> Formatted weight strings default to contain a 10-digit weight field (including sign and decimal point), followed by a space and a 2-digit unit identifier. Total field length with unit identifier is 13 characters. For tokens with an <i>x</i>, total field length with unit identifier is <i>x</i> + 3.</p>		
<i>Accumulator Tokens</i>		
<A>	Accumulated weight, current scale; Prints to 15 digits	GFMT, NFMT, ACMFMT
<A#n>	Accumulated weight, scale <i>n</i>	
<AA>	Average accumulation, current scale	
<AA#n>	Average accumulation, scale <i>n</i>	
<AC>	Number of accumulations, current scale	
<AC#n>	Number of accumulations, scale <i>n</i>	
<AT>	Time of last accumulation, current scale	
<AT#n>	Time of last accumulation, scale <i>n</i>	
<AD>	Date of last accumulation, current scale	
<AD#n>	Date of last accumulation, scale <i>n</i>	
<b>NOTE:</b> For tokens with # <i>n</i> , <i>n</i> is the scale number (1).		

Table 10-1. Print Format Tokens

Token	Description	Supported Ticket Formats
<i>Formatting and General-Purpose Tokens</i>		
<nnn>	ASCII character ( <i>nnn</i> = decimal value of ASCII character); used for inserting control characters (STX, for example) in the print stream	All
<TI>	Time	
<DA>	Date	
<TD>	Time and date	
<UID>	Unit ID number (up to 6 digits)	
<CN>	Consecutive number (up to 7 digits)	
<H1>	Insert header format 1 (HDFMT1), see <a href="#">Table 10-2</a>	
<H2>	Insert header format 2 (HDFMT2), see <a href="#">Table 10-2</a>	
<COMP>	Company name (up to 30 characters)	
<COAR1> <COAR2> <COAR3>	Contact company address, lines 1–3 (up to 30 characters)	
<CONM1> <CONM2> <CONM3>	Contact names (up to 20 characters)	
<COPH1> <COPH2> <COPH3>	Contact phone numbers (up to 20 characters)	
<COML>	Contact e-mail address (up to 30 characters)	
<CR>	Carriage return character	
<LF>	Line feed character	
<NLnn>	New line ( <i>nn</i> = number of termination (<CR/LF> or <CR>) characters)*	
<SPnn>	Space ( <i>nn</i> = number of spaces)*	
<SU>	Toggle weight data format (formatted/unformatted)	
<b>NOTE: If <i>nn</i> is not specified, 1 is assumed. Value must be in the range 1–99.</b>		

Table 10-1. Print Format Tokens (Continued)

Table 10-2 lists the default CLS-680 print formats:

Format	Default Format String	When Used
GFMT	GROSS<G><NL2><TD><NL>	Weigh mode – no tare in system
NFMT	GROSS<G><NL>TARE<SP><T><NL>NET<SP2><N> <NL2><TD><NL>	Weigh mode – tare in system
ACMFMT	ACCUM <A><NL><DA> <TI><NL>	Accumulator demand print format string
HDFMT1-2	COMPANY NAME<NL>STREET ADDRESS<NL>CITY ST ZIP<NL2>	

Table 10-2. Default Print Formats



**NOTE: The 1000 character limit of each print format string includes the output field length of the print formatting tokens, not the token length. For example, if the CLS-680 is configured to display a decimal point, the <G> token generates an output field of 13 characters: the 10 character weight value (including decimal point), one space, and a two-digit units identifier. For tokens with an *x* (e.g. <Gx> or <Gx#n>), total field length with unit identifier is  $x + 3$ .**

**PT (preset tare) is added to the tare weight if tare was keyed in.**

## 10.2 Customizing Print Formats

The GFMT, NFMT, ACMFMT and HDRFMT formats can be customized using the print format menu (PForMT) via the front panel. See [Section 4.4.6 on page 31](#) for the print format menu structure. To access the print format menu the CLS-680 must be in setup mode ([Section 4.1 on page 24](#)).

### 10.2.1 Using the Front Panel

Use the print format menu to customize the print formats and to edit the print format strings by changing the ASCII characters in the format string. See [Section 3.4.2 on page 19](#) for the alphanumeric entry procedure to edit the print format string.



**NOTE:** Some characters cannot be displayed on the CLS-680 front panel, see the ASCII character chart in [Section 11.5 on page 61](#) for available characters. The CLS-680 can send or receive ASCII characters; the character printed depends on the particular ASCII character set implemented for the receiving device.

## 10.3 Non-Human Readable Characters

ASCII characters 0 through 31 are non-human readable characters. Since these characters are not visible, they do not appear as selectable options in a CLS-680 print format. To include a special character in a print format, the decimal equivalent needs to be used.

For example, the special character *Esc* would be <27>.

*Examples of a print release command for a TMU295 in the GROSS format:*

**Print Format 1:**

GROSS<G><NL2><TD><NL><27>q

**Print Format 2:**

GROSS<G><NL2><TD><NL><27><113>

## 11.0 Appendix

### 11.1 Error Messages

The CLS-680 provides a number of error messages. Error messages appear or scroll on the display when an error occurs.

#### 11.1.1 Displayed Error Messages

The CLS-680 provides a number of front panel error messages to assist in problem diagnosis. [Table 11-1](#) lists these messages and their descriptions.

Error Message	Description
-----	Overflow error – Weight value too large to be displayed
nnnnnn	Gross > overload limit – Gross value exceeds overload limit; Check configuration or signal input level; Overload can be caused by input signal > 45 mV or common mode voltage > 950 mV
uuuuuu	Gross < underload limit – Gross value exceeds underload limit
Roll	Indicates the pitch and roll angle is outside the acceptable boundary for the weight to be measured
Low Battery	Scrolls across display every 30 seconds when battery is low
Tare in Motion Error	Scrolls across display when attempting to perform a tare while weight is in motion, if in motion tares are not allowed
Negative Tare Error	Scrolls across display when attempting to perform a negative tare, if a negative tare is not allowed
Keyed Tare Error	Scrolls across display when attempting to perform a keyed tare, if a keyed tare is not allowed
Tare Larger Than Capacity Error	Scrolls across display when attempting to perform a tare larger than capacity, if it is not allowed
Tare Already in System Error	Scrolls across display when attempting to perform a tare if a tare is already in the system, if tare is not configured to replace or remove
Initial Zero Failed	Scrolls across display when an attempt to perform an initial zero fails, only possible at startup
PLEASE WAIT	Scrolls across display when calibrating
??	Indicates a junction box error; usually includes a text description after the question marks to help clarify the issue
?? Serial Command	Indicates a serial command errors

Table 11-1. Error Messages

### 11.2 ZZ EDP Command

The ZZ EDP command can be used to remotely query the value currently displayed on the 6-digit display, along with the units and a number representing the current state of the eight LED annunciators. The number representing the LED annunciators currently lit ([Table 11-2](#)).

*Example: If the ZZ command returns: “2500 LB 145”, that means the weight on the display is 2500 pounds and the gross, standstill and lb annunciators are lit. The number 145 represents the sum of the values for the gross mode annunciator (16), the standstill annunciator (128) and the lb annunciator (1).*

Decimal Value	Annunciator
1	lb/primary units
2	kg/secondary units
4	Tare entered
8	Keyed tare entered
16	Gross
32	Net
64	Center of zero
128	Standstill

Table 11-2. Status Codes Returned on the ZZ Command



## 11.3 Continuous Data (Stream) Output Formats

When the trigger setting for a port is set to STRLFT, data is continuously streamed from the appropriate port in one of the four fixed format options or a custom format option.

### Fixed Format Options:

- Rice Lake Weighing Systems (Section 11.3.1)
- Cardinal (Section 11.3.2)
- Avery Weigh-Tronix (Section 11.3.3 on page 58)
- Mettler Toledo (Section 11.3.4 on page 58)

### 11.3.1 Rice Lake Weighing Systems Stream Format (rLW5)

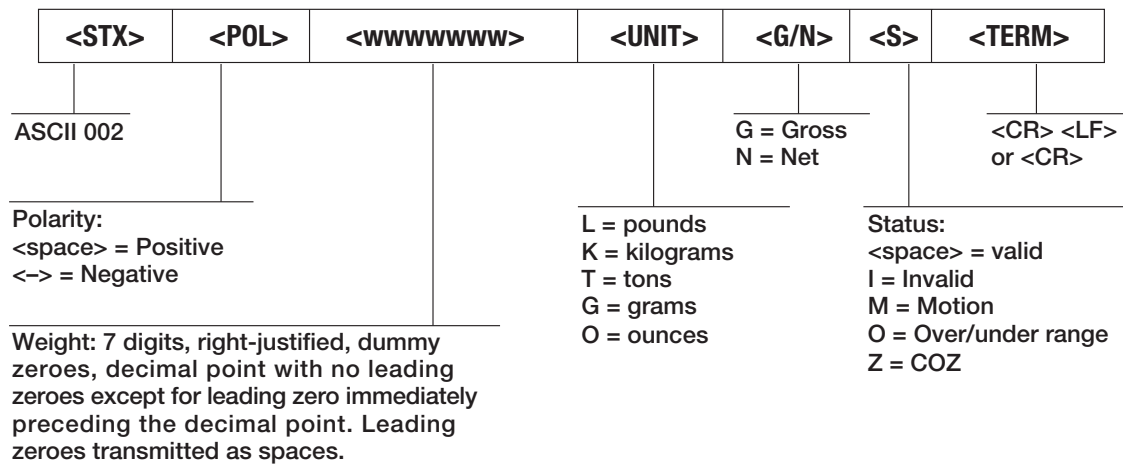

Figure 11-1. Rice Lake Weighing Systems Stream Data Format

### 11.3.2 Cardinal Stream Format (CR-dnRL)

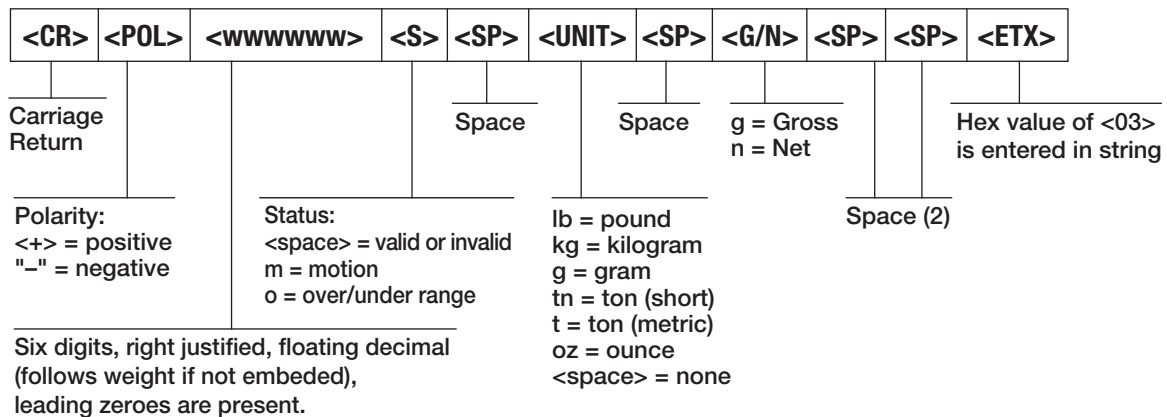

Figure 11-2. Cardinal Stream Data Format

### 11.3.3 Avery Weigh-Tronix Stream Format (αβγδϵζ)

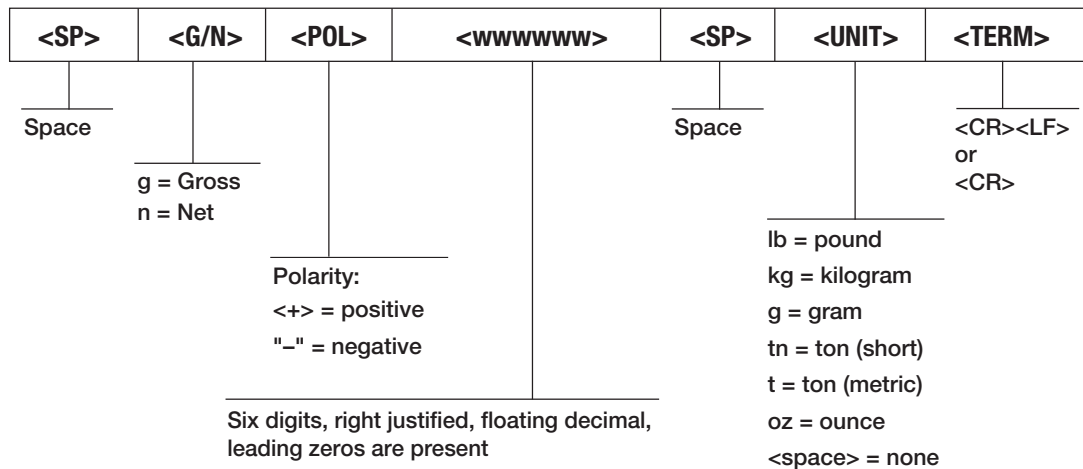

Figure 11-3. Avery Weigh-Tronix Stream Data Format

### 11.3.4 Mettler Toledo Stream Format (ηθικλμ)

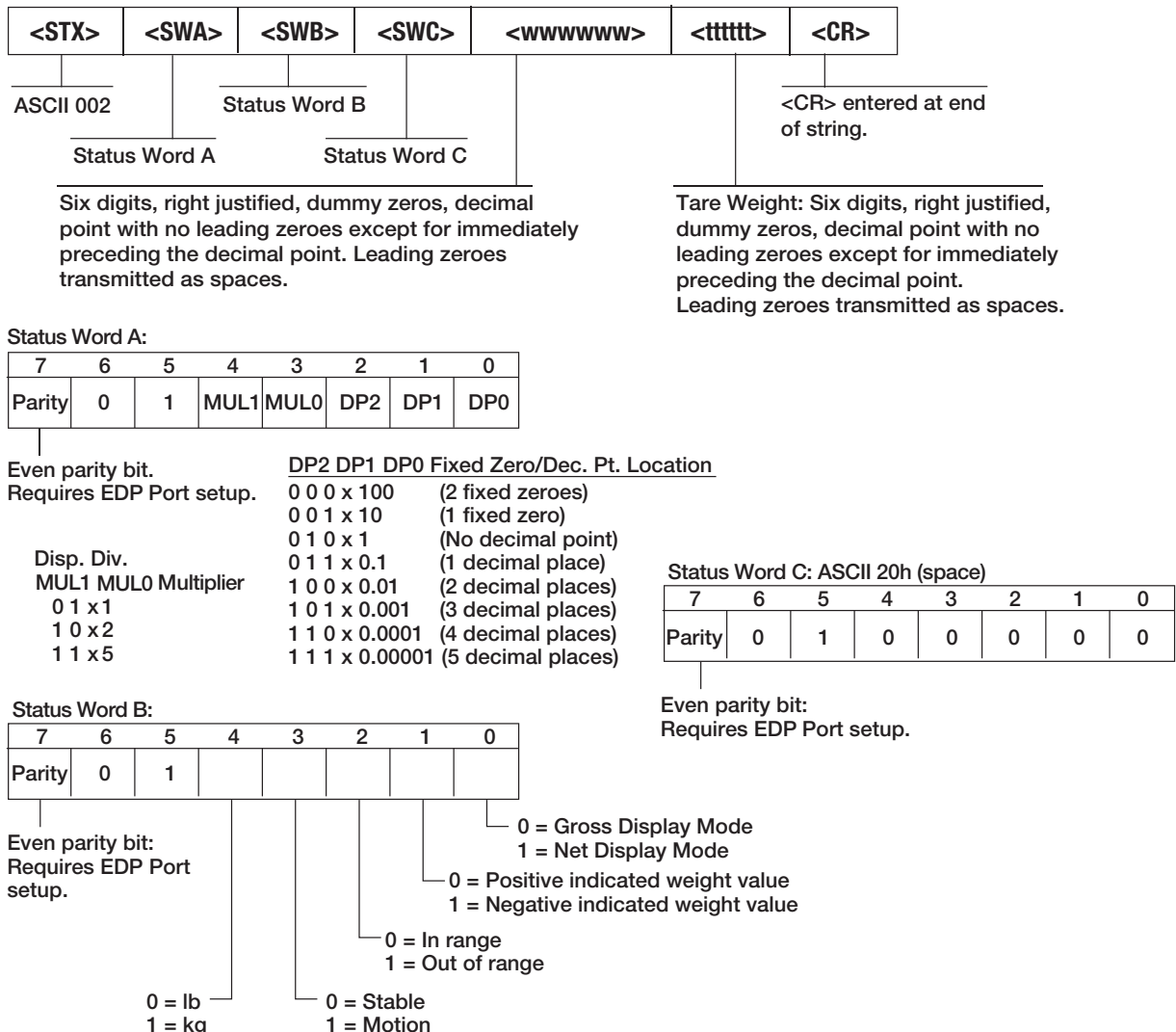

Figure 11-4. Mettler Toledo Stream Data Format

## 11.4 Custom Stream Formatting

The Custom stream format parameter can be configured in the Stream Format (SFORMAT) menu via the front panel. See [Section 4.4.7 on page 32](#) for the Stream Format menu structure. The indicator must be in setup mode ([Section 4.1 on page 24](#)) to access the Stream Format menu.

### Using the Front Panel

Use the Stream Format menu to customize the Custom parameter by changing the ASCII characters in the format string.

**SETUP ▼ to CONFIG ► to SFORMAT ▼ to SFMT (set to CUSTOM) ► to CUSTOM ▼ to format string entry**

See [Section 3.4.2 on page 19](#) for the alphanumeric entry procedure to edit the format string.



**NOTE:** The CLS-680 can send or receive ASCII characters; the character printed depends on the particular ASCII character set implemented for the receiving device. Some characters cannot be displayed on the CLS-680 front panel, see the ASCII character chart in [Section 11.5 on page 61](#) for available characters and see [Section 10.3 on page 55](#) for a description of Non-Human Readable Characters.

For example, enter the following string of format tokens to recreate the standard RLWS stream format as a custom stream format: <2><P><W7.><U><M><S><CR><LF>

- <2> Sends ASCII character 2, or STX.
- <P> Sends the Polarity character.
- <W7.> Sends 7 weight digits, no leading zeros, with a floating decimal point as needed.
- <U> Sends the Units.
- <M> Sends the Mode.
- <S> Sends the Status.
- <CR> Sends a Carriage Return.
- <LF> Sends a Line Feed.

### Custom Stream Format Tokens

Format Identifier	Defined By	Description
<P[G   N   T]>	STRM.POS# <i>n</i> STRM.NEG# <i>n</i>	Polarity – Specifies positive or negative polarity for the current or specified (Gross/Net/Tare) weight on the source scale; Possible values are SPACE, NONE, + (for STR.POS# <i>n</i> ) or – (for STR.NEG# <i>n</i> )
<U[P   S   T]>	STRM.PRI# <i>n</i> STRM.SEC# <i>n</i> STRM.TER# <i>n</i>	Units – Specifies primary, secondary or tertiary units for the current or specified weight on the source scale
<M[G   N   T]>	STRM.GROSS# <i>n</i> STRM.NET# <i>n</i> STRM.TARE# <i>n</i>	Mode – Specifies gross, net or tare weight for the current or specified weight on the source scale
<S>	STRM.MOTION# <i>n</i> STRM.RANGE# <i>n</i> STRM.OK# <i>n</i> STRM.INVALID# <i>n</i> STRM.ZERO# <i>n</i>	Status for the source scale – Default values and meanings for each status: <ul style="list-style-type: none"> <li>• STR.MOTION#<i>n</i> M In motion</li> <li>• STR.RANGE#<i>n</i> O Out of range</li> <li>• STR.OK#<i>n</i> &lt;space&gt; OK</li> <li>• STR.INVALID#<i>n</i> I Invalid</li> <li>• STR.ZERO#<i>n</i> Z COZ</li> </ul>
<UID>	UID	Unit ID number – Specifies the unit identification number of the junction box as a numeric value up to 6 digits long
<###>	--	To send an ASCII character; ### is a number 0 to 255; for example: <2> sends the ASCII character 2, Start of Text (STX) and the token <13> sends a Carriage Return
XXXX	--	To send literal characters; XXXX represents literal characters to include in the string by not including <>; for example: SCALE<W7.><U><CR><LF> will stream "SCALE 1234 L" with a weight of 1234 pounds
<B [-]n,...>	See descriptions below	Bit fields. Comma-separated sequence of bit field specifiers; Must be exactly 8-bits; minus sign ([-]) inverts the bit
B0	--	Always 0

Table 11-3. Custom Stream Format Tokens

Format Identifier	Defined By	Description
B1	--	Always 1
B2	Configuration	=1 if even parity
B3	Dynamic	=1 if MODE=NET
B4	Dynamic	=1 if COZ
B5	Dynamic	=1 if standstill
B6	Dynamic	=1 if gross negative
B7	Dynamic	=1 if out of range
B8	Dynamic	=1 if secondary
B9	Dynamic	=1 if tare in system
B10	Dynamic	=1 if tare is keyed
B11	Dynamic	=00 if MODE=GROSS =01 if MODE=NET =10 if MODE=TARE =11 (not used)
B12	Dynamic	=00 if UNITS=PRIMARY =01 if UNITS=SECONDARY =11 (not used)
B13	Configuration	=00 (not used) =01 if current DSPDIV=1 =10 if current DSPDIV=2 =11 if current DSPDIV=5
B14	Configuration	=00 (not used) =01 if primary DSPDIV=1 =10 if primary DSPDIV=2 =11 if primary DSPDIV=5
B15	Configuration	=00 (not used) =01 if secondary DSPDIV=1 =10 if secondary DSPDIV=2 =11 if secondary DSPDIV=5
B17	Configuration	=000 if current DECPNT=8888800      =100 if current DECPNT=88888.88 =001 if current DECPNT=8888880      =101 if current DECPNT=88888.888 =010 if current DECPNT=8888888      =110 if current DECPNT=888.8888 =011 if current DECPNT=888888.8      =111 if current DECPNT=88.88888
B18	Configuration	=000 if primary DECPNT=8888800      =100 if primary DECPNT=88888.88 =001 if primary DECPNT=8888880      =101 if primary DECPNT=88888.888 =010 if primary DECPNT=8888888      =110 if primary DECPNT=888.8888 =011 if primary DECPNT=888888.8      =111 if primary DECPNT=88.88888
B19	Configuration	=000 if secondary DECPNT=8888800      =100 if secondary DECPNT=88888.88 =001 if secondary DECPNT=8888880      =101 if secondary DECPNT=88888.888 =010 if secondary DECPNT=8888888      =110 if secondary DECPNT=888.8888 =011 if secondary DECPNT=888888.8      =111 if secondary DECPNT=88.88888
<wspec [-] [0] digit [.[.]digit]>	Scale weight	Weight for the source scale. <b>wspec</b> is defined as follows: <b>wspec</b> indicates whether the weight is the current displayed weight (W, w), gross (G, g), net (N, n) or tare (T, t) weight; Upper-case letters specify right-justified weights, lower-case are left-justified Optional /P or /S suffixes can be added before the ending delimiter (>) to specify weight display in primary (/P) or secondary (/S) units [-] Enter a minus sign (-) to include sign for negative values [0] Enter a zero (0) to display leading zeros digit[.[.]digit]  The first digit indicates the field width in characters; The decimal point only indicates a floating decimal; A decimal point with a following digit indicates fixed decimal with n digits to the right of the decimal; Two consecutive decimals send the decimal point even if it falls at the end of the transmitted weight field
<CR>	--	Carriage return
<LF>	--	Line feed

Table 11-3. Custom Stream Format Tokens (Continued)

## 11.5 ASCII Character Chart

Use the decimal values for ASCII characters listed in [Table 11-4](#) when specifying print format strings on the CLS-680 PFORMAT menu ([Section 4.4.6 on page 31](#)). The actual character printed depends on the character mapping used by the output device.

The CLS-680 can send or receive ASCII character values (decimal 0–255), but the CLS-680 display is limited to numbers, uppercase, unaccented letters and a few special characters. See [Section 11.8 on page 62](#) for the CLS-680 display characters.

Control	ASCII	Dec	Hex	ASCII	Dec	Hex	ASCII	Dec	Hex	ASCII	Dec	Hex
Ctrl-@	NUL	00	00	space	32	20	@	64	40	`	96	60
Ctrl-A	SOH	01	01	!	33	21	A	65	41	a	97	61
Ctrl-B	STX	02	02	"	34	22	B	66	42	b	98	62
Ctrl-C	ETX	03	03	#	35	23	C	67	43	c	99	63
Ctrl-D	EOT	04	04	\$	36	24	D	68	44	d	100	64
Ctrl-E	ENQ	05	05	%	37	25	E	69	45	e	101	65
Ctrl-F	ACK	06	06	&	38	26	F	70	46	f	102	66
Ctrl-G	BEL	07	07	'	39	27	G	71	47	g	103	67
Ctrl-H	BS	08	08	(	40	28	H	72	48	h	104	68
Ctrl-I	HT	09	09	)	41	29	I	73	49	i	105	69
Ctrl-J	LF	10	0A	*	42	2A	J	74	4A	j	106	6A
Ctrl-K	VT	11	0B	+	43	2B	K	75	4B	k	107	6B
Ctrl-L	FF	12	0C	,	44	2C	L	76	4C	l	108	6C
Ctrl-M	CR	13	0D	-	45	2D	M	77	4D	m	109	6D
Ctrl-N	SO	14	0E	.	46	2E	N	78	4E	n	110	6E
Ctrl-O	SI	15	0F	/	47	2F	O	79	4F	o	111	6F
Ctrl-P	DLE	16	10	0	48	30	P	80	50	p	112	70
Ctrl-Q	DC1	17	11	1	49	31	Q	81	51	q	113	71
Ctrl-R	DC2	18	12	2	50	32	R	82	52	r	114	72
Ctrl-S	DC3	19	13	3	51	33	S	83	53	s	115	73
Ctrl-T	DC4	20	14	4	52	34	T	84	54	t	116	74
Ctrl-U	NAK	21	15	5	53	35	U	85	55	u	117	75
Ctrl-V	SYN	22	16	6	54	36	V	86	56	v	118	76
Ctrl-W	ETB	23	17	7	55	37	W	87	57	w	119	77
Ctrl-X	CAN	24	18	8	56	38	X	88	58	x	120	78
Ctrl-Y	EM	25	19	9	57	39	Y	89	59	y	121	79
Ctrl-Z	SUB	26	1A	:	58	3A	Z	90	5A	z	122	7A
Ctrl-[	ESC	27	1B	;	59	3B	[	91	5B	{	123	7B
Ctrl-\	FS	28	1C	<	60	3C	\	92	5C		124	7C
Ctrl-]	GS	29	1D	=	61	3D	]	93	5D	}	125	7D
Ctrl-^	RS	30	1E	>	62	3E	^	94	5E	~	126	7E
Ctrl-_	US	31	1F	?	63	3F	_	95	5F	DEL	127	7F

Table 11-4. ASCII Character Chart

## 11.6 Audit Trail Support

Audit trail support provides tracking information for configuration and calibration events. To prevent potential misuse, all configuration and calibration changes are counted as change events.

Audit trail information can be accessed by sending the DUMPAUDIT serial command. The audit trail display includes the legally relevant (LR) version number (firmware version for the code which provides audit trail information), a calibration count and a configuration count.

See [Section 3.5.10 on page 21](#) for steps to view the Audit Trail counters.

## 11.7 Conversion Factors for Secondary Units

The CLS-680 has the capability to mathematically convert a weight into many different types of units and instantly display those results with a press of the **Units** key.

Secondary units can be specified on the Format menu using the **SECNDR** parameter.



**NOTE:** Multipliers are preconfigured within the CLS-680.

Ensure the secondary decimal point position is set appropriately for the scale capacity in the secondary units.

## 11.8 Front Panel Display Characters

Figure 11-5 shows the seven-segment LED character set used on the CLS-680 front panel display for alphanumeric characters.

!	8	7	8	Ff	8	Ss	8
"	8	8	8	Gg	8	Tt	8
+	8	9	8	Hh	8	Uu	8
-	8	:	8	li	8	Vv	8
.	8.	;	8	Jj	8	Ww	8
/	8	<	8	Kk	8	Xx	8
0	8	=	8	Ll	8	Yy	8
1	8	>	8	Mm	8	Zz	8
2	8	Aa	8	Nn	8	[	8
3	8	Bb	8	Oo	8	\	8
4	8	Cc	8	Pp	8	]	8
5	8	Dd	8	Qq	8	_	8
6	8	Ee	8	Rr	8		

Figure 11-5. CLS-680 Display Characters

## 12.0 Specifications

### Power

Line voltage: 9–36 VDC or 18–72 VDC

### Communication Ports

Two RS-232 full duplex (one reserved for CLS)

Bluetooth® SSP

WiFi: Wireless 802.11 b/g/n 2.5 GHz

Zigbee (CLS cableless option)

Micro USB (firmware updates only)

### Status Annunciators

Ten LED annunciators

### Display

Six 0.5 in (12.7 mm) tall, seven-segment digits

### Keys / Buttons

Flat membrane panel, tactile feel (18 buttons)

### Temperature Range

Legal: 14–104°F (-10–40°C)

Industrial: 14–122°F (-10–50°C)

### Dimensions (W x H x D)

6.5 x 5.2 x 3.3 in (16.5 x 13.2 x 8.4 cm)

### Weight

3.7 lb (1.7 kg)

### Material

Machined aluminum enclosure, anodized finish

### EMC Immunity

EN 50082 Part 2 IEC 61000-4-2,3,4,5,6,8 and 11

### Warranty

Two-year limited warranty

### Certifications and Approvals



NTEP

CoC Number: 21-092

Accuracy Class: III/IIIL;  $n_{max}$ : 5 000d



WiFi/Bluetooth®

FCC ID: SQG-EWB1

IC ID: 3147A-EWB1

Zigbee

FCC ID: MCQ-XBEE3

IC ID: 1846A-XBEE3

### Battery Specifications (Cableless Option)

Battery type: Lithium-Ion

Nominal capacity: 6600mAh

Nominal voltage: 11.1 V

Charging method: Constant current  
Constant voltage

Charging voltage: 12.6 V

Charging current: 4.0 A

Charging time: 100% at 8 hours

Maximum charge hours: 24 hours

Ambient temperature: Charge: 32–104°F (0–40°C)  
Discharge: -4–140°F (-20–60°C)  
Storage: -4–122°F (-20–50°C)

Weight: 430 g

Dimensions (D x L): 22.8 mm x 214.0 mm

### Battery Charging LED Signals (Cableless Option)

Off = No battery

Green flashing = Fast charging

Green solid = Fully charged

Yellow flashing = Recalibrating

Yellow/green alternating = Recalibrating

Yellow solid = Standby

Red flashing = Error



**NOTE:** See the CLS-Series Service Manual (PN 211569) for additional details and specifications on batteries and charging.









© Rice Lake Weighing Systems Content subject to change without notice.

230 W. Coleman St. • Rice Lake, WI 54868 • USA USA: 800-472-6703 • International: +1-715-234-9171