

# 420 Plus

*HMI Digital Weight Indicator  
Version 1.15*

## Installation Manual



**RICE LAKE**<sup>®</sup>  
WEIGHING SYSTEMS  
To be the best by every measure<sup>®</sup>

© Rice Lake Weighing Systems. All rights reserved.

Rice Lake Weighing Systems® is a registered trademark of  
Rice Lake Weighing Systems.

All other brand or product names within this publication are trademarks or  
registered trademarks of their respective companies.

All information contained within this publication is, to the best of our knowledge, complete and  
accurate at the time of publication. Rice Lake Weighing Systems reserves the right to make  
changes to the technology, features, specifications and design of the equipment without notice.

The most current version of this publication, software, firmware and all other product  
updates can be found on our website:

[www.ricelake.com](http://www.ricelake.com)

# Contents

- About This Manual ..... 1**
- Safety ..... 1**
- 1.0 Introduction..... 2**
  - 1.1 Operating Modes ..... 3
  - 1.2 Front Panel Keypad ..... 4
  - 1.3 LED Annunciators. .... 4
  - 1.4 Indicator Operations. .... 5
    - 1.4.1 Toggle Gross/Net Mode/Piece Count ..... 5
    - 1.4.2 Toggle Units ..... 5
    - 1.4.3 Zero Scale. .... 5
    - 1.4.4 Acquire Tare ..... 5
    - 1.4.5 Enter Tare (Keyed Tare). .... 5
    - 1.4.6 Remove Stored Tare Value ..... 6
    - 1.4.7 Acquire Parts Sample ..... 6
    - 1.4.8 Display Part Weight ..... 6
    - 1.4.9 Display Accumulator ..... 6
    - 1.4.10 Display or Change Time ..... 6
    - 1.4.11 Display or Change Setpoint Value ..... 7
    - 1.4.12 Turn Setpoint On or Off ..... 7
    - 1.4.13 Print Ticket ..... 7
    - 1.4.14 Enter New ID. .... 7
- 2.0 Installation ..... 8**
  - 2.1 Unpacking and Assembly ..... 8
  - 2.2 Enclosure Disassembly. .... 8
  - 2.3 Cable Connections. .... 8
    - 2.3.1 Cable Grounding. .... 9
    - 2.3.2 Bypass Power Button ..... 9
    - 2.3.3 DC Power Wiring Guidelines ..... 11
    - 2.3.4 Load Cells. .... 12
    - 2.3.5 Serial Communications ..... 12
    - 2.3.6 Digital I/O ..... 12
    - 2.3.7 Analog Output. .... 13
  - 2.4 Analog Output Module Installation ..... 13
  - 2.5 Enclosure Reassembly ..... 13
  - 2.6 Board Removal ..... 13
  - 2.7 Replacement Parts. .... 14
- 3.0 Configuration ..... 17**
  - 3.1 Configuration Methods. .... 17
    - 3.1.1 Revolution Configuration ..... 17
    - 3.1.2 EDP Command Configuration ..... 17
    - 3.1.3 Front Panel Configuration ..... 18
  - 3.2 Menu Structures and Parameter Descriptions. .... 19
    - 3.2.1 Configuration Menu ..... 19
    - 3.2.2 Format Menu. .... 21
    - 3.2.3 Calibration Menu ..... 23
    - 3.2.4 Serial Menu ..... 24

3.2.5	Program Menu . . . . .	25
3.2.6	Print Format Menu . . . . .	27
3.2.7	Setpoint Menu . . . . .	27
3.2.8	Digital Input Menu . . . . .	29
3.2.9	Analog Output Menu . . . . .	30
3.2.10	Version Menu . . . . .	31
<b>4.0</b>	<b>Calibration</b> .....	<b>32</b>
4.1	Front Panel Calibration . . . . .	32
4.2	EDP Command Calibration . . . . .	33
4.3	Revolution Calibration . . . . .	33
4.4	More About Calibration . . . . .	34
4.4.1	Adjusting Final Calibration . . . . .	34
4.4.2	Zero Deadload A/D Counts . . . . .	34
<b>5.0</b>	<b>EDP Commands</b> .....	<b>35</b>
5.1	The EDP Command Set . . . . .	35
5.1.1	Key Press Commands . . . . .	35
5.1.2	Reporting Commands . . . . .	36
5.1.3	The RESETCONFIGURATION Command . . . . .	36
5.1.4	Parameter Setting Commands . . . . .	36
5.1.5	Soft Reset . . . . .	36
5.1.6	Normal Mode Commands . . . . .	39
5.2	Saving and Transferring Data . . . . .	40
5.2.1	Saving Indicator Data to a Personal Computer . . . . .	40
5.2.2	Downloading Configuration Data from PC to Indicator . . . . .	40
<b>6.0</b>	<b>Print Formatting</b> .....	<b>41</b>
6.1	Print Formatting Commands . . . . .	41
6.2	Customizing Print Formats . . . . .	42
6.2.1	Using the EDP Port . . . . .	42
6.2.2	Using the Front Panel . . . . .	42
6.2.3	Using Revolution . . . . .	43
<b>7.0</b>	<b>Appendix</b> .....	<b>44</b>
7.1	Error Messages . . . . .	44
7.1.1	Displayed Error Messages . . . . .	44
7.1.2	Using the XE EDP Command . . . . .	45
7.2	Status Messages . . . . .	45
7.2.1	Using the P EDP Command . . . . .	45
7.2.2	Using the ZZ EDP Command . . . . .	45
7.3	Continuous Output (Stream) Format . . . . .	46
7.4	ASCII Character Chart . . . . .	47
7.5	Front Panel Display Characters . . . . .	49
7.6	Conversion Factors for Secondary Units . . . . .	50
7.7	Digital Filtering . . . . .	51
7.7.1	DIGFLx Parameters . . . . .	51
7.7.2	DFSENS and DFTHRH Parameters . . . . .	51
7.7.3	Setting the Digital Filter Parameters . . . . .	52
7.8	Analog Output Calibration . . . . .	52
7.9	Test Mode . . . . .	53
7.10	Regulatory Mode Functions . . . . .	54
7.11	LED Functions . . . . .	54
7.12	Specifications . . . . .	55
	<b>420 Plus Limited Warranty</b> .....	<b>56</b>

# About This Manual

---

This manual is intended for use by service technicians responsible for installing and servicing 420 Plus HMI digital weight indicators. This manual applies to indicators using Version 1.14 of the 420 Plus software.

Configuration and calibration of the indicator can be accomplished using the indicator front panel keys, the EDP command set, or the *Revolution*® configuration utility. See Section 3.1 on page 17 for information about configuration methods.



This manual can be viewed from the Rice Lake Weighing Systems distributor site at [www.ricelake.com](http://www.ricelake.com).

The *Operator Card* included with this manual provides basic operating instructions for users of the 420 Plus. Please leave the *Operator Card* with the indicator when installation and configuration are complete.

## Safety

---

### Safety Symbol Definitions



Indicates a potentially hazardous situation that, if not avoided, could result in serious injury or death, and includes hazards that are exposed when guards are removed.



Indicates a potentially hazardous situation that, if not avoided may result in minor or moderate injury.



Indicates information about procedures that, if not observed, could result in damage to equipment or corruption to and loss of data.

### Safety Precautions



Do not operate or work on this equipment unless you have read and understand the instructions and warnings in this Manual. Failure to follow the instructions or heed the warnings could result in injury or death. Contact any Rice Lake Weighing Systems dealer for replacement manuals. Proper care is your responsibility.



Some procedures described in this manual require work inside the indicator enclosure. These procedures are to be performed by qualified service personnel only.

## General Safety

---



*Failure to heed may result in serious injury or death.*

**DO NOT** allow minors (children) or inexperienced persons to operate this unit.

**DO NOT** operate without all shields and guards in place.

**DO NOT** step on the unit.

**DO NOT** jump up and down on the scale.

**DO NOT** use for purposes other than weight taking.

**DO NOT** place fingers into slots or possible pinch points.

**DO NOT** use any load-bearing component that is worn beyond 5% of the original dimension.

**DO NOT** use this product if any of the components are cracked.

**DO NOT** exceed the rated load limit of the unit.

**DO NOT** make alterations or modifications to the unit.

**DO NOT** remove or obscure warning labels.

**DO NOT** use near water.

Before opening the unit, ensure the power cord is disconnected from the outlet.

Keep hands, feet and loose clothing away from moving parts.

# 1.0 Introduction

---

The *420 Plus* is a single-channel digital weight indicator housed in a NEMA Type 4X/IP66-rated stainless steel enclosure. The indicator front panel consists of a large (.8 in, 20 mm), six-digit, seven-segment LED display and twenty-one-button keypad. Features include:

- Drives up to eight 350 $\Omega$  or sixteen 700 $\Omega$  load cells
- Supports 4- and 6-wire load cell connections
- Two configurable digital inputs
- Two configurable digital outputs
- Electronic data processing (EDP) port for full duplex, RS-232 communications at up to 38400 bps
- Printer port for output-only RS-232 or 20 mA current loop communications at up to 38400 bps
- Optional analog output module provides 0–10 VDC or 0–20/4–20 mA tracking of gross or net weight values
- Available in 115 VAC and 230 VAC versions
- Available in DC power version

The *420 Plus* is NTEP-certified and pending Measurement Canada approval for Classes III, III HD, and III L at 10,000 divisions. See Section 7.12 on page 55 for detailed specifications.

## 1.1 Operating Modes

The *420 Plus* has four modes of operation:

### Weigh (Primary) mode

Normal mode is the “default” mode of the indicator. The indicator displays gross or net weights as required, using the LED annunciators described in Section 1.3 on page 4 to indicate scale status and the type of weight value displayed. Once configuration is complete and a legal seal is affixed to the back of the indicator, this is the primary mode in which the *420 Plus* can operate.

### Piece Count (Secondary) Mode

In piece count mode, the indicator display shows the number of parts on the scale rather than the weight of those parts. Piece count mode has two submodes:

- Count display mode displays the current parts count and allows ticket printing using the CFMT print format.
- Sample acquisition mode is used to calibrate the indicator for parts counting.

Operator access to piece count mode is disabled when the indicator is shipped from the factory.

### Setup mode

Most of the procedures described in this manual require the indicator to be in setup mode, including configuration and calibration.

To enter setup mode, remove the large fillister head screw from the bottom of the enclosure. Insert a screwdriver or a similar tool into the access hole and press the setup switch once. The indicator display changes to show the word *CONFIG*.

### Test mode

Test mode provides a number of diagnostic functions for the *420 Plus* indicator. Like setup mode, test mode is entered using the setup switch. See Section 7.9 on page 53 for more information about entering and using test mode.

## 1.2 Front Panel Keypad

Figure 1-1 shows the *420 Plus* LED annunciators, keypad, and normal mode key functions.

The symbols shown above the keys (representing up, down, enter, left, right) describe the key functions assigned in setup mode. In setup mode, the keys are used to navigate through menus, select digits within numeric values, and increment/decrement values. See Section 3.1.3 on page 18 for information about using the front panel keys in setup mode.



Figure 1-1. *420 Plus* Front Panel, Showing LED Annunciators and Normal Mode Key Functions

## 1.3 LED Annunciators

The *420 Plus* display uses a set of eight LED annunciators to provide additional information about the value being displayed:

- **Gross** and **Net** annunciators are lit to show whether the displayed weight is a gross or net weight.
- Center of zero (→0←): Gross weight is within 0.25 graduations of zero. This annunciator lights when the scale is zeroed.
- Standstill (▲▲): Scale is at standstill or within the specified motion band. Some operations, including tare functions and printing, can only be done when the standstill symbol is shown.
- **lb** and **kg** annunciators indicate the units associated with the displayed value: lb=pounds, kg=kilograms.
- The displayed units can also be set to short tons (tn), metric tons (t), ounces (oz), grams (g), or NONE (no units information displayed). The **lb** and **kg** LEDs function as primary and secondary units annunciators for some combinations of primary and secondary units. If neither primary nor secondary units are lb or kg the **lb** annunciator is lit for primary units, **kg** for secondary units.
- The **Count** annunciator is lit to show that the indicator is in piece count mode.
- The Tare Acquired (⬆) lights to show that a tare value was entered.

Table 1-1 shows which annunciators are used for all combinations of configured primary and secondary units. For example:

- If the primary unit is pounds (lb) and the secondary unit is kilograms (kg), the **lb** LED is lit for primary units, **kg** for secondary units.
- If the primary unit is pounds (lb) and the secondary unit is short tons (tn), the **lb** LED is lit for primary units, **kg** for secondary units. There is not an LED for short tons, so the **kg** LED is used as the secondary units annunciator.
- If the primary unit is short tons (tn) and the secondary unit is pounds (lb), the **lb** LED is lit for primary units (tn), and **kg** is lit for secondary units (lb). Because there is no LED for short tons, the **lb** and **kg** LEDs are used as primary and secondary units annunciators.

See Section on page 21 for more information about configuring primary and secondary display units.

Primary Unit	Secondary Unit						
	lb	kg	oz	g	tn	t	none
lb	lb / lb	lb / kg	lb / oz	lb / g	lb / kg		
kg	kg / lb	kg / kg	kg / oz	kg / g	lb / kg		
oz	oz / lb	oz / kg	oz / oz	oz / g	oz / kg		
g	g / lb	g / kg	g / oz	g / g	g / kg		
tn	lb / kg	lb / kg	lb / oz	lb / g	lb / lb	lb / kg	lb / kg
t					lb / kg	lb / lb	lb / kg
none					lb / kg	lb / kg	lb / lb

Table 1-1. Units Annunciators, Showing Primary / Secondary LEDs Used for All Configurations

## 1.4 Indicator Operations

Basic 420 Plus operations are summarized below.

### 1.4.1 Toggle Gross/Net Mode/Piece Count

Press the **GROSS/NET** key to switch the display mode from gross to net, or from net to gross. If a tare value has been entered or acquired, the net value is the gross weight minus the tare.

Gross mode is shown by the **Gross** annunciator; net mode is shown by the **Net** annunciator.

### 1.4.2 Toggle Units

Press the **UNITS** key to switch between primary and secondary units. The appropriate units LED to the right of the display is lit.

### 1.4.3 Zero Scale

1. In gross mode, remove all weight from the scale and wait for the standstill annunciator (▲▲).
2. Press the **ZERO** key. The center of zero (→0←) annunciator lights to indicate the scale is zeroed.

### 1.4.4 Acquire Tare

1. Place container on scale and wait for the standstill annunciator (▲▲).
2. Press the **TARE** key to acquire the tare weight of the container. Net weight is displayed and the (◊T) annunciator lights to show the tare value was entered

### 1.4.5 Enter Tare (Keyed Tare)

1. Use the numeric keypad to enter the tare value, then press the **TARE** key.
2. Net weight is displayed and the (◊T) annunciator lights to show the tare value was entered.

## 1.4.6 Remove Stored Tare Value

1. Remove all weight from the scale and wait for the standstill annunciator (▲▲).
2. Press the TARE key. The (T) annunciator goes off, indicating the tare value has been removed.



**Note** Indicators with the REGULA parameter set to NONE or NTEP (see Section 3.2.5 on page 25) can clear a stored tare value using the following procedure:

1. Press DISPLAY TARE to show the stored tare value.
2. Press the CLEAR key twice to remove the stored tare.

## 1.4.7 Acquire Parts Sample

1. Place empty parts container on scale. Wait for the standstill annunciator (▲▲), then press TARE to acquire the tare weight of the container.
2. Press MODE (GROSS/NET) key to enter piece count mode.  
Press the CLEAR key to exit.
3. Press the SAMPLE (UNITS) key to enter sample acquisition mode.

The indicator display shows the message *Addnnn*, where *nnn* is the sample quantity to be placed on the scale. You can do one of the following:

- Add the number of parts shown.
  - Choose a different sample size. Press the SAMPLE key to scroll through the selectable sample quantities (5, 10, 20, 50, 100) or use the numeric keypad to specify a custom sample size.
  - Specify a known piece weight. Press the SAMPLE key to scroll through the selectable sample quantities until the *PC WGT* prompt is shown. Use the numeric keypad to enter the piece weight.
4. Once the sample quantity is on the scale, press ENTER to calibrate the indicator for counting the new parts. If a sample size was specified, the indicator display shows the message *-CNT-* as it acquires the sample weight, then switches to count display mode and shows the part quantity. If a known piece weight was specified, the display switches to count display mode immediately.

## 1.4.8 Display Part Weight

To view gross and net weight parts, press MODE to switch from count display mode to normal weighing mode. To view the current piece weight while in count mode, press DISPLAY TARE key

## 1.4.9 Display Accumulator

Hold the (MODE) GROSS/NET key for three seconds to display the accumulated value if enabled in configuration.

The accumulated value will be displayed for about 10 seconds. To clear the accumulator, press the CLR key twice while the accumulated value is being displayed.

## 1.4.10 Display or Change Time

To display the date, press the TIME/DATE key once; press TIME/DATE a second time to display the time.

To set the date, press the TIME/DATE key once. Use the numeric keypad to enter the date, then press the ENTER key. Use the numeric keypad to enter the date in the same format configured for the indicator: *MMDDYY*, *DDMMYY*, or *YYMMDD*.

To set the time, press the TIME/DATE key twice. Use the numeric keypad to enter the time in 24-hour format, then press the ENTER key.



**Note** The time and date is backed up with the battery. If the main power is interrupted, time/date should not be lost.

### 1.4.11 Display or Change Setpoint Value

To display a setpoint value, use the numeric keypad to enter the setpoint number, then press the **SETPOINT** key. Or, you can display a setpoint value by pressing the **SETPOINT** key a number of times equal to the setpoint number. For example, to display the value of setpoint 2, press the **SETPOINT** key two times.

The current value will display, use the numeric keypad to enter the new value and press the **ENTER** key. This will bring you back to the TRIP submenu. To exit and save, press the **UNITS** (◀) and **PRINT** (▶) keys and **ZERO** (△) and **GROSS/NET** (▽) to navigate to the CONFIG menu. Press △ to exit and save. Use Figure 3-11, “Setpoint Menu,” on page 27 to navigate the menus.

### 1.4.12 Turn Setpoint On or Off

To turn a setpoint on or off at the front panel, press the **SETPOINT** key a number of times equal to the setpoint number (for example, for setpoint number 2 press the **SETPOINT** key two times). Press **TARE** to exit value input mode and go left to **ENABLE** and use the down arrow key to select **On** or **Off**. At this point if the setpoint is on, you can turn it off by using the right or left arrow keys.

### 1.4.13 Print Ticket

1. Wait for standstill annunciator (  ).
2. Press the **PRINT** key to send data to the serial port.

### 1.4.14 Enter New ID

1. Ensure digital input 1 or digital input 2 is configured for NEWID.
2. Activate the digital input.
3. Once activated, the digital input will go into ID mode.
4. Enter the ID using the numeric keypad and press **TARE**.

## 2.0 Installation

This section describes procedures for connecting load cells, digital inputs, and serial communications cables to the *420 Plus* indicator. Instructions for field installation of the analog output option and replacement of the CPU board are included, along with assembly drawings and parts lists for the service technician.



- Use a wrist strap to ground yourself and protect components from electrostatic discharge (ESD) when working inside the indicator enclosure.
- This unit uses line fusing which could create an electric shock hazard. Procedures requiring work inside the indicator must be performed by qualified service personnel only.
- The supply cord serves as the main power disconnect for the *420 Plus*. The power outlet supplying the indicator must be installed near the unit and be easily accessible

### 2.1 Unpacking and Assembly

Immediately after unpacking, visually inspect the *420 Plus* to ensure all components are included and undamaged. The shipping carton should contain the indicator with attached tilt stand, this manual, and a parts kit. If any parts were damaged in shipment, notify Rice Lake Weighing Systems and the shipper immediately.

The parts kit (PN 85219) contains the items listed below:

- Two, six-position screw terminals (PN 70599) for connectors J4 & J1, two, three-position screw terminals (PN 71125) for connectors J2 and J3, and one, four-position screw terminal (PN 71126) for connector J6 (see figure 2-4).
- Two 8-32NC x 7/16 fillister head screws (PN 30623).
- Four 8-32NC x 3/8 machine screws (PN 14862) for the indicator backplate (see #1 in Figure 2-8 15).
- Six neoprene washers (PN 45042) for backplate screws included in the parts kit.
- Four rubber bumpers (“feet”) for the tilt stand, (PN 42149).
- Three reducing glands (PN 15664).
- One capacity label (PN 42350).
- Three each of grounding clamps (PN 53075), external tooth lock washers (PN 15133), and kep nuts (PN 14626) for cable shield grounding against the enclosure.

- One SEC C (section cap) and CLC (Concentrated Load) (PN 85552) label.
- Annunciator labels (PN 85555), replacement overlay decals for labeling primary and secondary units LEDs.

### 2.2 Enclosure Disassembly

The indicator enclosure must be opened to connect cables for load cells, communications, digital inputs, and analog output.



*The 420 Plus has an on/off switch for the load cells and processor functions. Before opening the unit, ensure the power cord is disconnected from the power outlet. The power outlet must be located near the indicator to allow the operator to easily disconnect power to the unit.*

Ensure power to the indicator is disconnected, then place the indicator face-down on an antistatic work mat. Remove the screws that hold the backplate to the enclosure body, then lift the backplate away from the enclosure and set it aside.

### 2.3 Cable Connections

The *420 Plus* provides four cord grips for cabling into the indicator: one for the power cord, three to accommodate load cell, communications, digital inputs, and analog output cables. Two of the three free cord grips come with a plug installed to prevent moisture from entering the enclosure. Depending on your application, remove the plug from any cord grip that will be used and install cables as required.



*The unit will keep the date and time as long as it is plugged in. Even if display and load cells are turned off. When the unit is unplugged, it will lose date and time information.*

Figure 2-1 shows the recommended assignments for the *420 Plus* cord grips.

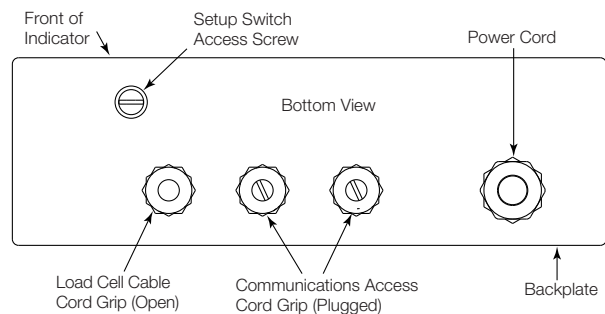

Figure 2-1. Recommended Cord Grip Assignments

### 2.3.1 Cable Grounding

Except for the power cord, all cables routed through the cord grips should be grounded against the indicator enclosure. Do the following to ground shielded cables:

- Use the lockwashers, clamps, and keps provided in the parts kit to install grounding clamps on the enclosure studs adjacent to cord grips. Install grounding clamps only for cord grips that will be used; do not tighten nuts.
- Route cables through cord grips and grounding clamps to determine cable lengths required to reach cable connectors. Mark cables to remove insulation and shield as described below:
- For cables with foil shielding, strip insulation and foil from the cable half an inch (15 mm) past the grounding clamp (see Figure 2-2). Fold the foil shield back on the cable where the cable passes through the clamp. Ensure silver (conductive) side of foil is turned outward for contact with the grounding clamp.
- For cables with braided shielding, strip cable insulation and braided shield from a point just past the grounding clamp. Strip another half inch (15 mm) of insulation *only* to expose the braid where the cable passes through the clamp (see Figure 2-2).
- For load cell cables, cut the shield wire just past the grounding clamp. Shield wire function is provided by contact between the cable shield and the grounding clamp.
- Route stripped cables through cord grips and clamps. Ensure shields contact grounding clamps as shown in Figure 2-2. Tighten grounding clamp nuts.

- Finish installation using cable mounts and ties to secure cables inside of indicator enclosure.

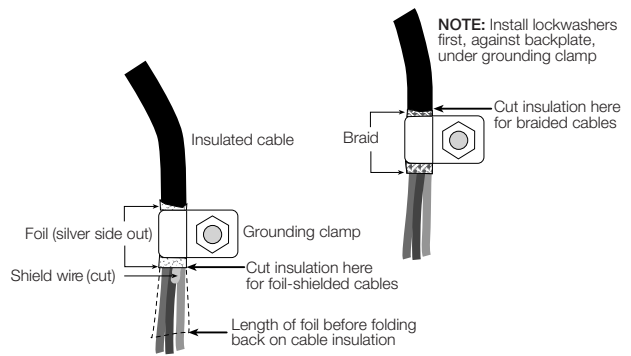

Figure 2-2. Grounding Clamp Attachment for Foil-Shielded and Braided Cabling

### 2.3.2 Bypass Power Button

If jumper JMP1 is set for SW position, the power switch on the front panel of the indicator will turn the unit ON or OFF. If it is not in the SW position, the indicator will power up as soon as the AC is applied. This allows the front panel overlay power control switch to be bypassed. Label “F” in Figure 2-3 shows the location of JMP1. Figure 2-4 on page 10 shows entire board.

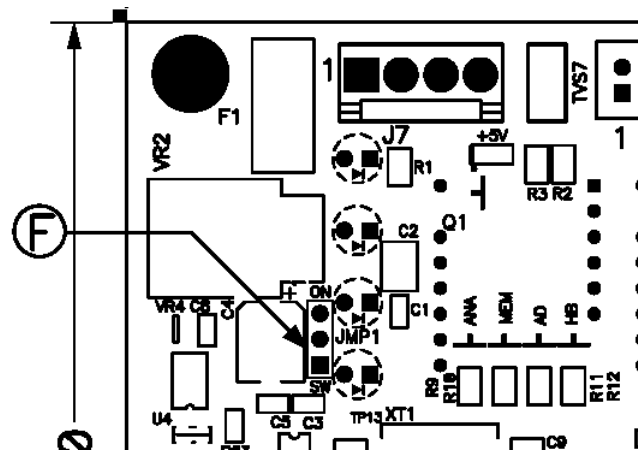

Figure 2-3. 420 Plus CPU and Power Supply Board JMP1 Shunt Location

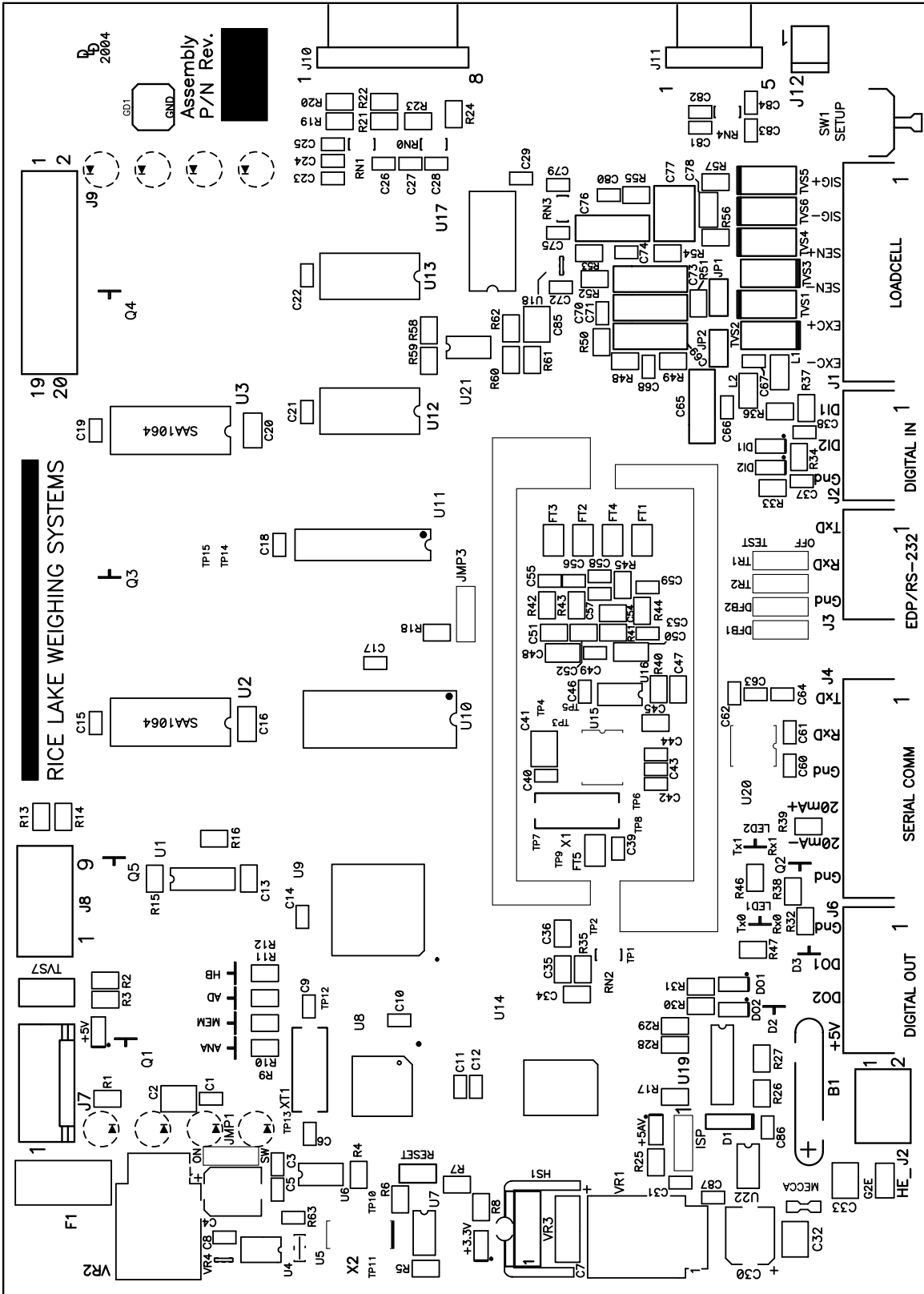

Figure 2-4. 420 Plus CPU and Power Supply Board

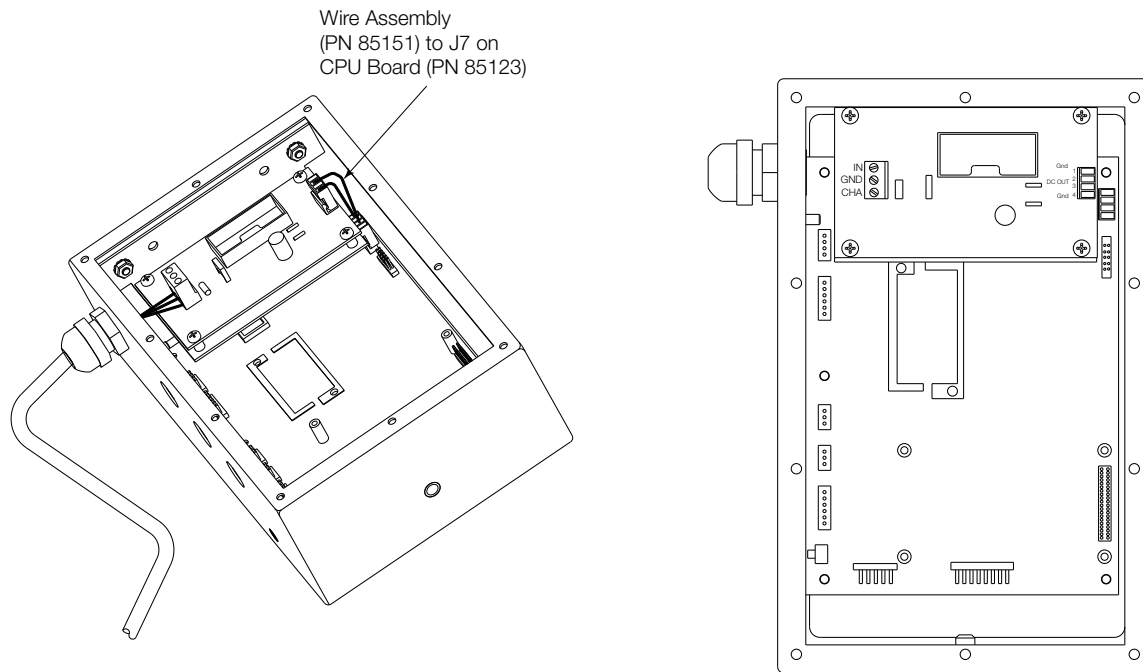

Figure 2-5. 420 Plus DC Power Supply

### 2.3.3 DC Power Wiring Guidelines

Based on:

- 8 x 350Ω
- Analog output installed
- Digital outputs sourcing 20mA each
- Drawing maximum current at 7.5 VDC from the DC/DC power supply



**Note** DC power wiring to the indicator should be 18 AWG to 14 AWG for DC+, DC-, and earth ground conductors.

In a mobile application, earth ground (chassis) should be terminated to the vehicle chassis.

In longer power cable runs, voltage drop over the power conductor needs to be considered. See table and formula below to compute voltage drop.

$$V_{\text{DROP}} = (2.85\text{A})(x\Omega / 1000\text{ft})(\text{length of run in ft.})$$

2.85A = maximum current draw from DC/DC power supply

$x\Omega$  = Ohms from Table 2-1

Wire Gauge (AWG)	Cable Impedance (OHMS/1000ft)
14	2.252Ω
15	3.184Ω
16	4.016Ω
17	5.064Ω
18	6.385Ω

Table 2-1. Cable Impedance



**Note** DC voltage supplied to DC/DC power supply should not be less than 9VDC. Using larger gauge wire will result in less voltage drop.

Example:

100ft run with 18 AWG wire

$$V_{\text{DROP}} = (2.85\text{A})(6.385\Omega / 1000\text{ft})(100 \text{ ft})$$

$$V_{\text{DROP}} = 1.82\text{V}$$

12VDC will drop to 10.18V after 100ft run.

### 2.3.4 Load Cells

To attach cable from a load cell or junction box, remove connector J1 from the board. The connector plugs into a header on the board as shown in Figure 2-4 10.

Using one of the 6-position connectors, provided in the parts kit, wire the load cell cable from the load cell or junction box to connector J1 on the CPU board (See Figure 2-4 10). If using six-wire load cell cable (with sense wires), remove jumpers JP1 and JP2 before reinstalling connector J1 (see Figure 2-4). For four-wire installation, leave jumpers JP1 and JP2 on. When connections are complete, reinstall connector J1 onto the header so that it snaps securely into place. Use two cable ties to secure the load cell cable to the inside of the enclosure.

J1 Pin	Function
1	+SIG
2	-SIG
3	+SENSE
4	-SENSE
5	+EXC
6	-EXC

Table 2-2. J1 Pin Assignments



**Note** Use grounding procedures described in Section 2.3.1 on page 9

For 6-wire connections, remove jumpers JP1 and JP2

For 4-wire connections, leave jumpers JP1 and JP2 on

### 2.3.5 Serial Communications

Using one of the six-position connectors, provided in the parts kit, wire the serial communications cables to J4. Connector J3 provides connections for the EDP/RS-232 port. Connect communications cables to connectors J3 and J4 as shown in Table 2-3.

Once cables are attached, reconnect J3 and J4 to the headers on the board (see Figure 2-4). Use cable ties to secure serial cables to the inside of the enclosure.

The EDP port supports full duplex RS-232 communications only; the serial port provides either active 20 mA output or duplex RS-232 transmission. Both ports are configured using the SERIAL menu. See Section 3.0 on page 17 for configuration information.

Port	Connector	Pin	Label
EDP/RS-232	J3	1	TxD
		2	RxD
		3	Gnd

Table 2-3. J3 and J4 Pin Assignments

Port	Connector	Pin	Label
Serial Port	J4	1	TxD
		2	RxD
		3	Gnd
		4	20mA+
		5	20mA-
		6	Gnd

Table 2-3. J3 and J4 Pin Assignments

### 2.3.6 Digital I/O

Digital inputs can be set to provide several indicator functions, including all keypad functions. The inputs are active (on) with low voltage (0 VDC) and can be driven by TTL or 5V logic without additional hardware. Use the DIG IN menu to configure the digital inputs. LED's on the CPU board light when digital inputs are active.

Digital outputs are typically used to control relays that drive other equipment. Outputs are designed to sink not source, switching current. Each output is a normally open connector circuit, capable of sinking 250 mA when active. Digital outputs are wired to switch relays when the digital output is active (low, 0 VDC) with reference to 5 VDC supply. LEDs on the CPU board light when the digital outputs are active.

Port	Connector	Pin	Label
Digital Input	J2	1	DI 1
		2	DI 2
		3	Gnd
Digital Output	J6	1	Gnd
		2	DO 1
		3	DO 2
		4	+5V

Table 2-4. J2 and J6 Pin Assignments

### 2.3.7 Analog Output

If the optional analog output module is installed, attach the output cable to connector J1 on the analog output board. Table 2-5 lists the analog output pin assignments.

Use the ALGOUT menu to configure and calibrate the analog output module when cabling is complete. See Section 2.4 for information about installing the analog output module.

Pin	Signal
1	+ Current Out
2	- Current Out
3	+ Voltage Out
4	- Voltage Out

Table 2-5. Analog Output Module Pin Assignments

### 2.4 Analog Output Module Installation

To install or replace the analog output module (PN 85659), follow the steps listed in Section 2.2 on page 8 for opening the 420 Plus enclosure.

Mount the analog output module on its standoffs in the location shown in Figure 2-4 10 and plug the module input into connector J9 on the 420 Plus board. Connect output cable to the analog output module as shown in Table 2-5, then reassemble the enclosure (Section 2.5).

See Figure 7.8 52 for analog output calibration procedures.

### 2.5 Enclosure Reassembly

Once cabling is complete, position the backplate over the enclosure and reinstall the backplate screws. Use the torque pattern shown in Figure 2-6 to prevent distorting the backplate gasket. Torque screws to 15 in-lb (1.7 N-m).

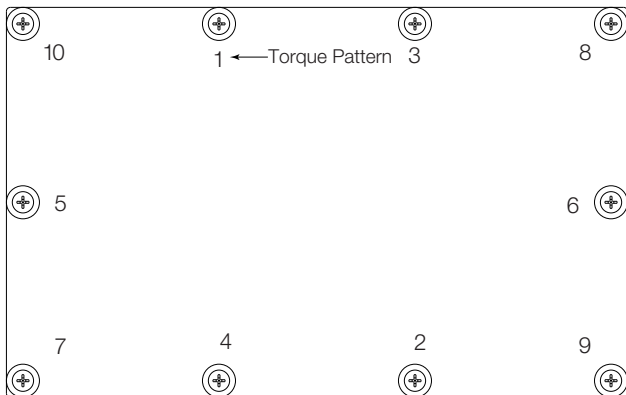

Figure 2-6. 420 Plus Enclosure Backplate

Torqued screws may become less tight as the gasket is compressed during torque pattern, therefore a second torque is required using the same pattern and torque value.

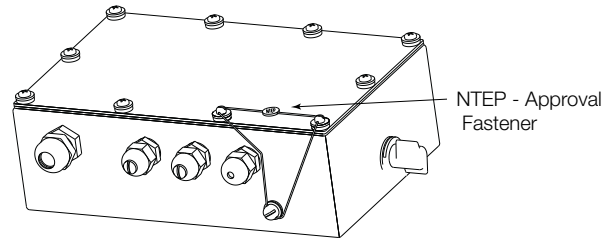

Figure 2-7. NTEP Sealing

### 2.6 Board Removal

If you must remove the 420 Plus CPU board, use the following procedure:

1. Disconnect power to the indicator. Remove backplate as described in Section 2.2 on page 8.
2. Disconnect power supply cable from connector J7 on the 420 Plus CPU board.
3. Unplug connectors J1 (load cell cable), J2 (digital inputs), J3 (EDP/RS-232), J4 (serial communications), J6 (digital outputs), and J10 & J11 (keypad ribbon cables). If an analog output board is installed, disconnect the analog output cable. See Figure 2-4 10 for connector locations.
4. Remove the five screws from the CPU board, then lift the board out of the enclosure.

To replace the CPU board, reverse the above procedure. Be sure to reinstall cable ties to secure all cables inside the indicator enclosure.

## 2.7 Replacement Parts

Table 2-6 lists replacement parts for the 420 Plus, including all parts referenced in Figures 2-8 and 2-9.

Ref Number	PN	Description (Quantity)	Figure
1	14862	Screws 8-32NC x 3/8 (8)	Figure 2-9 16
2	45042	Sealing washers (8)	
3	84387	Backplate (1)	
4	84388	backplate gasket (1)	
5	14839	Screws 6-32NC x 1/4 (9)	
6	85123	CPU and display board assembly (1)	
7	84386	Enclosure (1)	
8	15144	Nylon washers 1/4x1x1/16 (2)	
9	68403	Four-cornered wing knobs for tilt stand (2)	
10	29635	Tilt stand (1)	
11	44676	Sealing washer (1)	
12	42640	Screws 1/4-28NF X 1/4 (2)	
13	19538	Cable grip plugs (2)	
14	15626	Cable grips (3)	
15	30375	Nylon seal rings for cable grips (3)	
16	85202	Power cord assembly – 115 VAC	
	85203	Power cord assembly – 220 VAC	
17	84389	Power supply bracket (1)	
18	76556	Power supply switch (1)	
	85554	Power supply, DC/DC converter	
20	84397	Overlay panel (1)	Figure 2-8 15
21	68216	Rice Lake nameplate (1)	
22	85151	Power supply ribbon cable(1)	
23	16892	Earth ground label (1)	
24	15134	Lock washer, No 8, Type A (3)	
25	45043	Ground wire 4 in, No. 8 (1)	
27	14626	Kep nuts, 8-32NC Hex (5)	
28	15627	Locknuts (3)	
30	85494	Protective cover (1)	Figure 2-9 16
32	15376	Standoffs, male - female (6)	
	85791	Fuse, 2.5 Amp 5x20mm	

Table 2-6. Replacement Parts

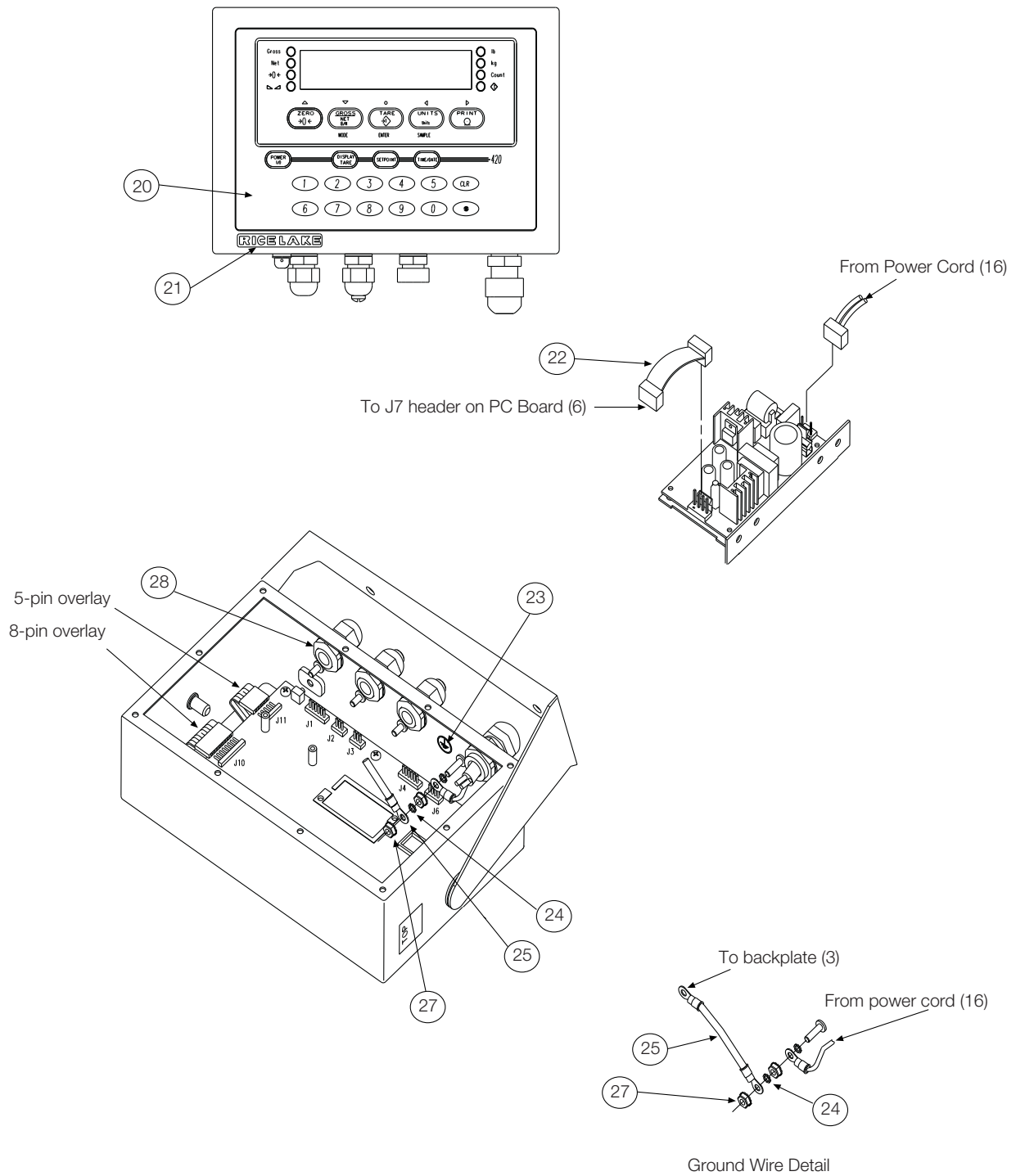

Figure 2-8. 420 Plus Overlay and Power Supply

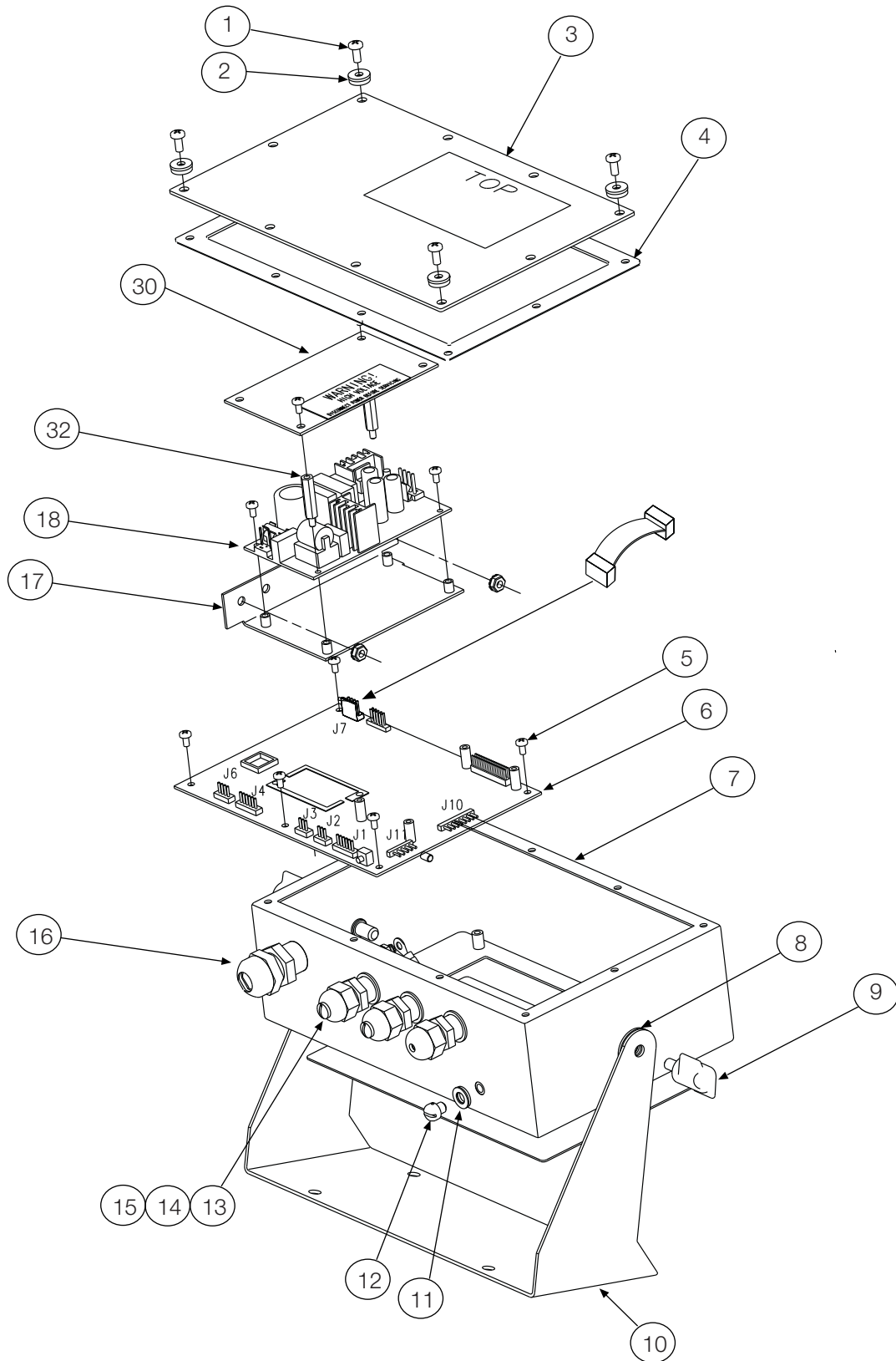

Figure 2-9. 420 Plus Enclosure, Backplate and CPU Board

## 3.0 Configuration

To configure the *420 Plus* indicator, the indicator must be placed in setup mode. The setup switch is accessed by removing the large fillister head screw on the enclosure bottom. Switch position is changed by inserting a screwdriver or similar tool into the access hole and pressing the setup switch.

When the indicator is placed in setup mode, the word *CONFIG* is shown on the display. The *CONFIG* menu is the first of ten main menus used to configure the indicator. Detailed descriptions of these menus are given in Section 3.2 on page 19. When configuration is complete, return to the *CONFIG* menu and press the  $\Delta$  (**ZERO**) key to exit setup mode, then replace the setup switch access screw.

### 3.1 Configuration Methods

The *420 Plus* indicator can be configured by using the front panel keys to navigate through a series of configuration menus or by sending commands or configuration data to the EDP port. Configuration using the menus is described in Section 3.1.3 on page 18.

Configuration using the EDP port can be accomplished using either the EDP command set described in Section 5.0 or the *Revolution*® software.

#### 3.1.1 Revolution Configuration

The *Revolution* configuration utility provides the preferred method for configuring the *420 Plus* indicator. *Revolution* runs on a personal computer to set configuration parameters for the indicator. When *Revolution* configuration is complete, configuration data is downloaded to the indicator.

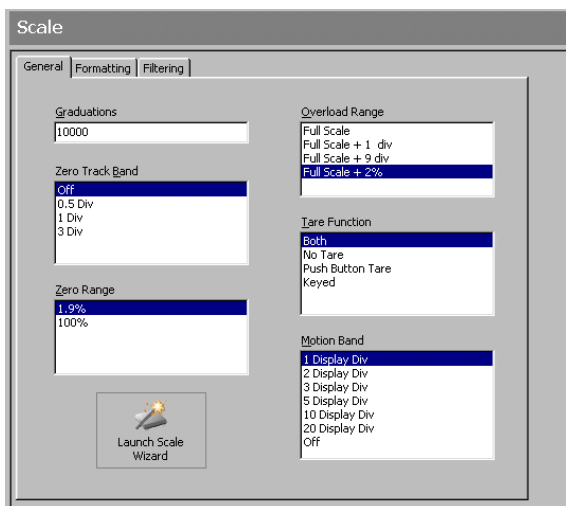

Figure 3-1. Sample Revolution Configuration Display

*Revolution* supports both uploading and downloading of indicator configuration data. This capability allows configuration data to be retrieved from one indicator, edited, then downloaded to another.

To use *Revolution*, do the following:

1. Install the *Revolution* module on an IBM-compatible personal computer running Windows® 98 or later. Minimum system requirements are 4MB of extended memory and at least 5MB of available hard disk space.
2. With both indicator and PC powered off, connect the PC serial port to the indicator EDP port.
3. Power up the PC and the indicator. Use the setup switch to place the indicator in setup mode.
4. Start the *Revolution* program.

Figure 3-1 shows an example of one of the *Revolution* configuration displays.

*Revolution* provides online help for each of its configuration displays. Parameter descriptions provided in this manual for front panel configuration can also be used when configuring the indicator using *Revolution*: the interface is different, but the parameters set are the same.

#### 3.1.2 EDP Command Configuration

The EDP command set can be used to configure the *420 Plus* indicator using a personal computer, terminal, or remote keyboard. Like *Revolution*, EDP command configuration sends commands to the indicator EDP port; unlike *Revolution*, EDP commands can be sent using any external device capable of sending ASCII characters over a serial connection.

EDP commands duplicate the functions available using the indicator front panel and provide some functions not otherwise available. EDP commands can be used to simulate pressing front panel keys, to configure the indicator, or to dump lists of parameter settings. See Section 5.0 on page 35 for more information about using the EDP command set.

### 3.1.3 Front Panel Configuration

The 420 Plus indicator can be configured using a series of menus accessed through the indicator front panel when the indicator is in setup mode. Table 3-1 summarizes the functions of each of the main menus.

Menu		Menu Function
CONFIG	Configuration	Configure grads, zero tracking, zero range, motion band, overload, tare function, sample rate, and digital filtering parameters.
FORMAT	Format	Set format of primary and secondary units, display rate.
CALIBR	Calibration	Calibrate indicator. See Section 4.0 on page 32 for calibration procedures.
SERIAL	Serial	Configure EDP and printer serial ports.
PROGRM	Program	Set power-up mode, regulatory mode, and consecutive number values.
PFORMT	Print Format	Set print format used for gross and net tickets. See Section 6.0 on page 41 for more information.
SETPNT	Setpoint	Configure Setpoints and digital outputs.
DIG IN	Digital Input	Assign digital input functions.
ALGOUT	Analog Output	Configure analog output module. Used only if analog output option is installed.
VERS	Version	Display installed software version number.

Table 3-1. 420 Plus Menu Summary

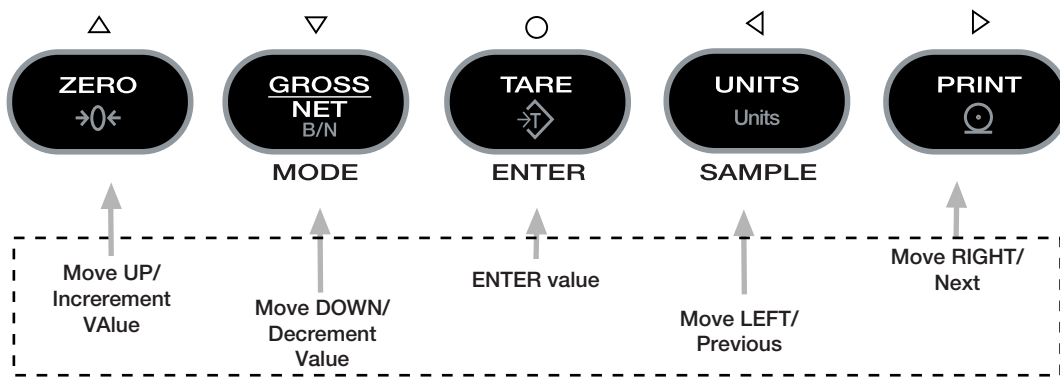
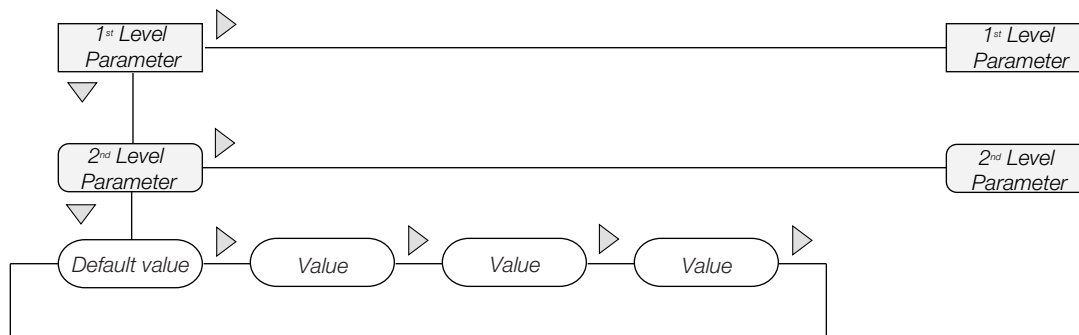

Figure 3-2. Front Panel Key Functions in Setup Mode

Four front panel keys are used as directional keys to navigate through the menus in setup mode (see Figure 3-2). The **UNITS** (◀) and **PRINT** (▶) keys scroll left and right (horizontally) on the same menu level; **ZERO** (▲) and **GROSS/NET** (▼) move up and down (vertically) to different menu levels. The **TARE** key (○) serves as an Enter key for selecting parameter values within the menus. A label above each of these keys identifies the direction provided by the key when navigating through the setup menus.



When moving through values below the first menu level, press ▲ to return to the level above. Press ○ or ▼ to move to the next parameter on the level above

Figure 3-3. Setup Mode Menu Navigation

To select a parameter, press ◀ or ▶ to scroll left or right until the desired menu group appears on the display, then press ▼ to move down to the submenu or parameter you want. When moving through the menu parameters, the default or previously selected value appears first on the display.

To change a parameter value, scroll left or right to view the values for that parameter. When the desired value appears on the display, press ○ to select the value and move back up one level. To edit numerical values, use the navigation keys to select the digit and to increment or decrement the value or use the numeric keypad. (see Figure 3-4).

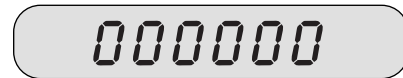

When editing numeric values, press ◀ or ▶ to change the digit selected. Press ▲ or ▼ to increment or decrement the value of the selected digit, or use the numeric keypad.

Press ○ to save the value entered and return to the level above.

Figure 3-4. Editing Procedure for Numeric Values

## 3.2 Menu Structures and Parameter Descriptions

The following sections provide graphic representations of the 420 Plus menu structures. In the actual menu structure, the settings you choose under each parameter are arranged horizontally. To save page space, menu choices are shown in vertical columns. The factory default setting appears at the top of each column in bold type.

Most menu diagrams are accompanied by a table that describes all parameters and parameter values associated with that menu. Default parameter values are shown in bold type.

### 3.2.1 Configuration Menu

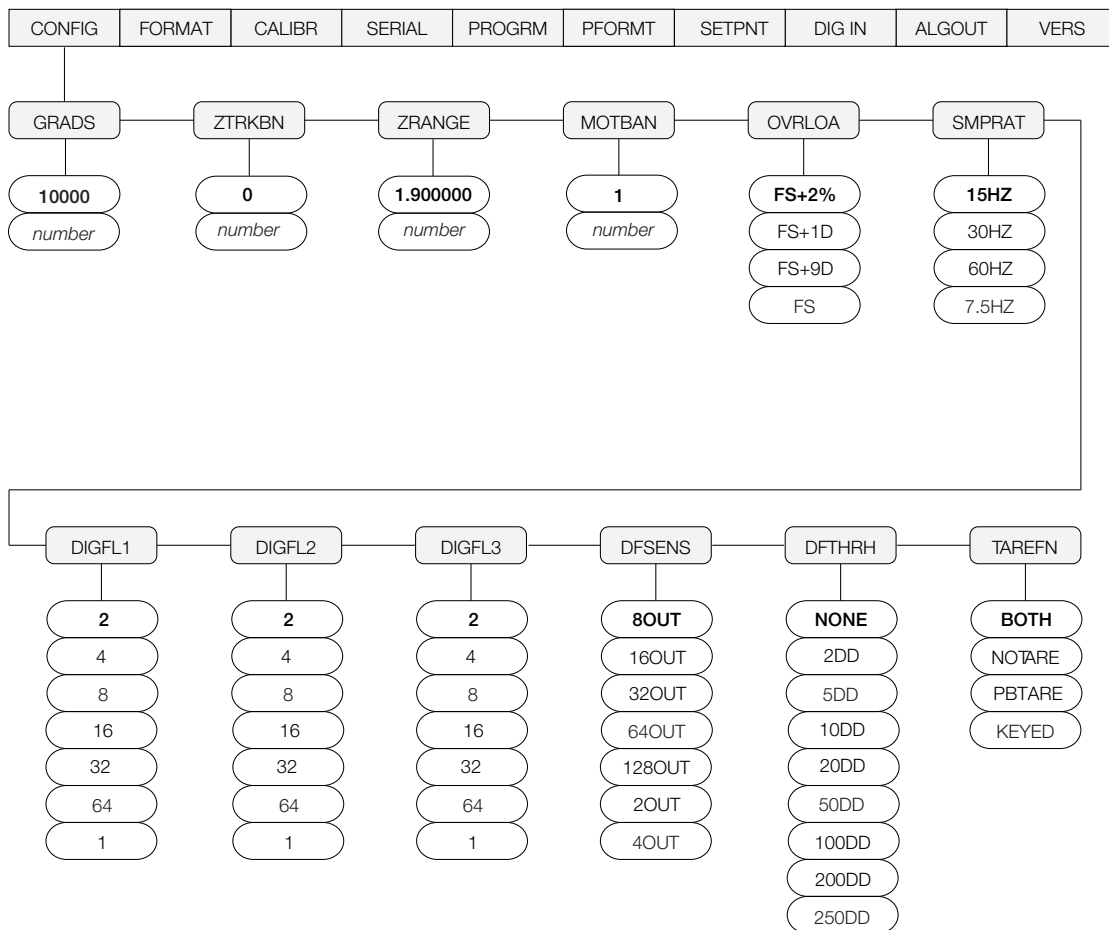

Figure 3-5. Configuration Menu

<b>CONFIG Menu</b>		
<b>Parameter</b>	<b>Choices</b>	<b>Description</b>
<b>Level 2 submenus</b>		
GRADS	<b>10000</b> <i>number</i>	Graduations. Specifies the number of full scale graduations. The value entered must be in the range 1–100 000 and should be consistent with legal requirements and environmental limits on system resolution.  To calculate GRADS, use the formula, $GRADS = Capacity / Display Divisions$ .  Display divisions for primary and secondary units are specified on the FORMAT menu.
ZTRKBND	0 <i>number</i>	Automatically zeroes the scale when within the range specified, as long as the input is within the ZRANGE and scale is at standstill. Specify the zero tracking band in $\pm$ display divisions. Maximum legal value varies depending on local regulations.   <b>Note</b> <i>For scales using linear calibration, do not set the zero tracking band to a value greater than that specified for the first linearization point.</i>
ZRANGE	1.900000 <i>number</i>	Selects the range within which the scale can be zeroed. The 1.900000 default value is $\pm$ 1.9% around the calibrated zero point, for a total range of 3.8%. Indicator must be at standstill to zero the scale. Use the default value for legal-for-trade applications.
MOTBAND	1 <i>number</i>	Sets the level, in display divisions, at which scale motion is detected. If motion is not detected for 1 second or more, the standstill symbol lights. Some operations, including print, tare, and zero, require the scale to be at standstill. Maximum legal value varies depending on local regulations.  If this parameter is set to 0, the standstill annunciator will be set continuously on, and operations including zero, print, and tare will be performed regardless of scale motion. If 0 is selected, ZTRKBND must also be set to 0.
OVRL0A	<b>FS+2%</b> FS+1D FS+9D FS	Overload. Determines the point at which the display blanks and an out-of-range error message is displayed. Maximum legal value varies depending on local regulations.
SMPRAT	<b>15HZ</b> 30HZ 60HZ 7.5HZ	Sample rate. Selects measurement rate, in samples per second, of the analog-to-digital converter. Lower sample rate values provide greater signal noise immunity.
DIGFL1 DIGFL2 DIGFL3	<b>2</b> 4 8 16 32 64 1	Digital filtering. Selects the digital filtering rate used to reduce the effects of mechanical vibration from the immediate area of the scale.  Choices indicate the number of A/D conversions that are averaged to obtain the displayed reading. A higher number gives a more accurate display by minimizing the effect of a few noisy readings, but slows down the settling rate of the indicator. See Section 7.7 on page 51 for more information on digital filtering.
DFSENS	<b>8OUT</b> 16OUT 32OUT 64OUT 128OUT 2OUT 4OUT	Digital filter cutout sensitivity. Specifies the number of consecutive readings that must fall outside the filter threshold (DFTHR parameter) before digital filtering is suspended. If NONE is selected, the filter is always enabled.

Table 3-2. Configuration Menu Parameters

CONFIG Menu		
Parameter	Choices	Description
DFTHRH	<b>NONE</b> 2DD 5DD 10DD 20DD 50DD 100DD 200DD 250DD	Digital filter cutout threshold. Specifies the filter threshold, in display divisions. When a specified number of consecutive scale readings (DFSSENS parameter) fall outside of this threshold, digital filtering is suspended. If NONE is selected, the filter is always enabled.
TAREFN	<b>BOTH</b> NOTARE PBTARE KEYED	Tare function. Enables or disables push-button and keyed tares. Possible values are:  BOTH:Both push-button and keyed tares are enabled NOTARE:No tare allowed (gross mode only) PBTARE:Push-button tares enabled KEYED:Keyed tare enabled

Table 3-2. Configuration Menu Parameters (Continued)

### 3.2.2 Format Menu

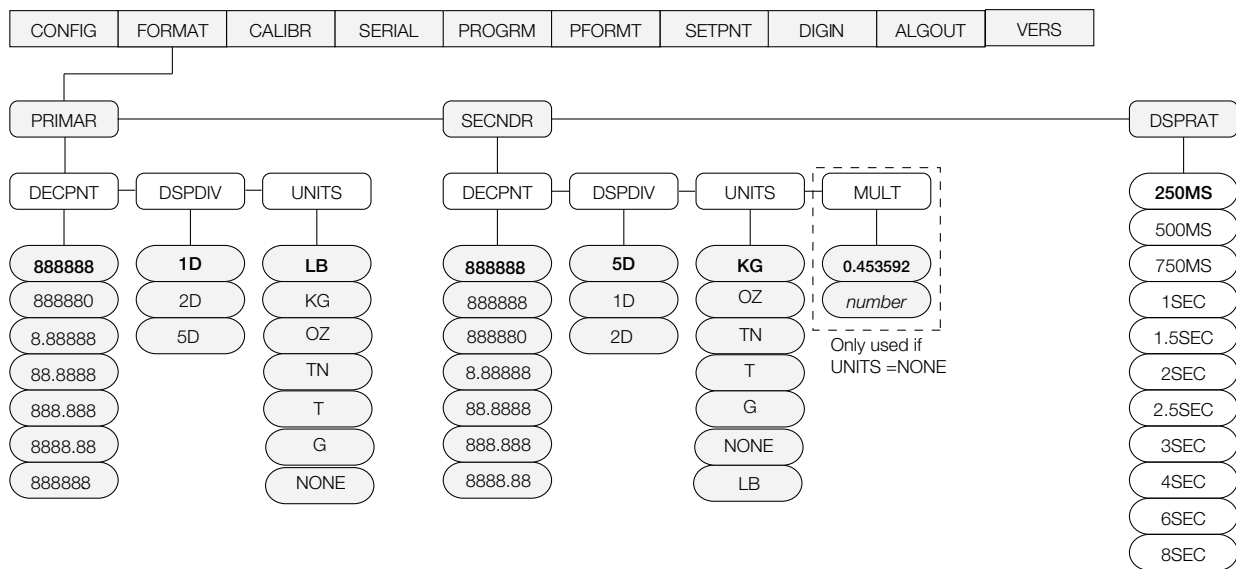

Figure 3-6. Format Menu

FORMAT Menu		
Parameter	Choices	Description
<b>Level 2 submenus</b>		
PRIMAR	DECPNT DSPDIV UNITS	Specifies the decimal position, display divisions, and units used for the primary units. See Level 3 submenu parameter descriptions.
SECNDR	DECPNT DSPDIV UNITS MULT	Specifies the decimal position, display divisions, units, and conversion multiplier used for the secondary units. See Level 3 submenu parameter descriptions.

Table 3-3. Format Menu Parameters



<b>FORMAT Menu</b>		
<b>Parameter</b>	<b>Choices</b>	<b>Description</b>
DSPRAT	<b>250MS</b> 500MS 750MS 1SEC 1.5SEC 2SEC 2.5SEC 3SEC 4SEC 6SEC 8SEC	Display rate. Sets the update rate for displayed values. Values are in milliseconds (MS) or seconds (SEC).
<b>Level 3 submenus</b>		
<b>Primary Units (PRIMAR Parameter)</b>		
DECPNT	<b>888888</b> 888880 8.88888 88.8888 888.888 8888.88 88888.8	Decimal point location. Specifies the location of the decimal point or dummy zeroes in the primary unit display. Value should be consistent with local legal requirements.
DSPDIV	<b>1D</b> 2D 5D	Display divisions. Selects the minimum division size for the primary units displayed weight.
UNITS	<b>LB</b> KG OZ TN T G NONE	Specifies primary units for displayed and printed weight. Values are: LB=pound; KG=kilogram; OZ=ounce; TN=short ton; T=metric ton; G=gram   <b>Note</b> <i>Indicators sold outside North America are configured with KG for both primary and secondary units.</i>
<b>Secondary Units (SECNDR Parameter)</b>		
DECPNT	<b>88888.8</b> 888888 888880 8.88888 88.8888 888.888 8888.88	Decimal point location. Determines the location of the decimal point or dummy zeros in the secondary unit display.
DSPDIV	<b>5D</b> 1D 2D	Display divisions. Selects the value of minimum division size of the displayed weight.
UNITS	<b>KG</b> OZ TN T G NONE LB	Specifies secondary units for displayed and printed weight. Values are: KG=kilogram; OZ=ounce; TN=short ton; T=metric ton; G=gram; LB=pound.
MULT	<b>0.453592</b> <i>Enter other choices via keyboard</i>	Multiplier. Specifies the conversion factor by which the primary units are multiplied to obtain the secondary units. The default is 0.453592, which is the conversion factor for changing pounds to kilograms. See Section 7.6 on page 50 for a list of multipliers.   <b>Note</b> <i>Multipliers are pre-configured within the indicator. Manual entry is only necessary when NONE is selected under UNITS.</i>  To toggle between primary and secondary units, press the <b>UNITS</b> key.

Table 3-3. Format Menu Parameters (Continued)

### 3.2.3 Calibration Menu

See Section 4.0 on page 32 for Calibration procedures.

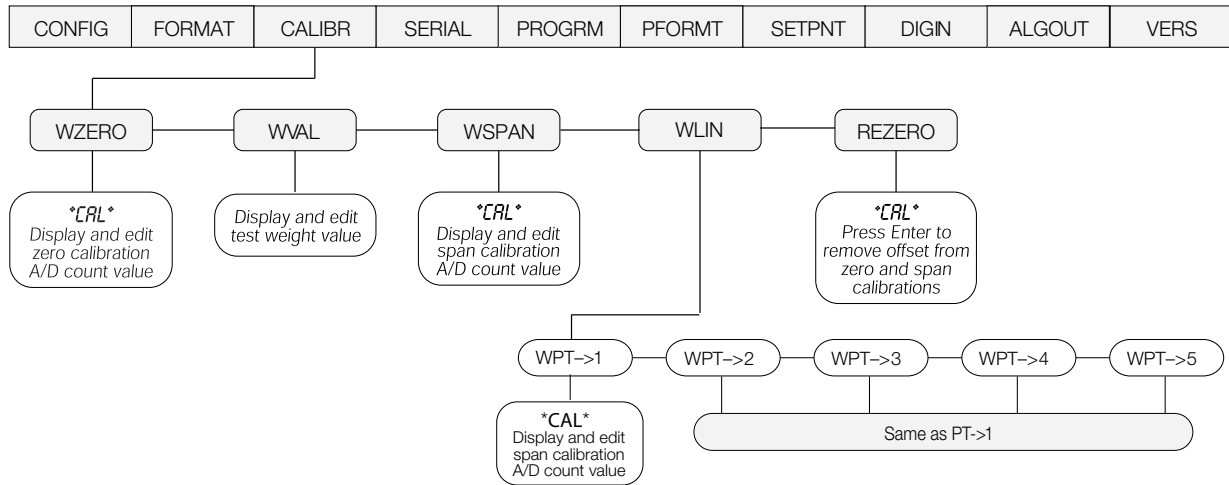

Figure 3-7. Calibration Menu

CALIBR Menu		
Parameter	Choices	Description
<b>Level 2 submenus</b>		
WZERO	—	Display and edit the zero calibration A/D count value. <i>DO NOT adjust this value after WSPAN has been set!</i>
WWAL	—	Display and edit the test weight value.
WSPAN	—	Display and edit the span calibration A/D count value.
WLIN	WPT->1 — WPT->5	Press ENTER to display and edit test weight value. Pressing ENTER again will calibrate and display the raw A/D value. Pressing ENTER a third time will move to the next calibration point.  For millivolt calibration, press ENTER to display and edit the test weight value. Press ENTER again to display and edit the millivolt value for that weight. Press ENTER a third time to calibrate and display the raw A/D value. Press ENTER the fourth time to move to the next point.
REZERO	—	Press Enter to remove an offset value from the zero and span calibrations if hooks or chains are being used during calibration.  Always use this parameter after WZERO and WSPAN have been set to re-capture a new zero value. See Section 4.1 on page 32 for more information about using this parameter.

Table 3-4. Calibration Menu Parameters

### 3.2.4 Serial Menu

See Section 7.3 on page 46 for information about the *420 Plus* serial data format.

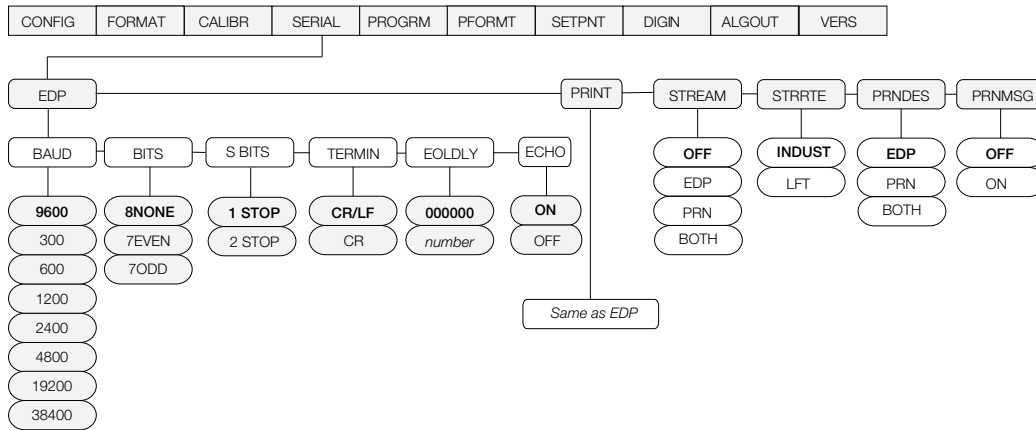

Figure 3-8. Serial Menu

SERIAL Menu		
Parameter	Choices	Description
<b>Level 2 submenus</b>		
EDP	BAUD BITS TERMIN EOLDLY ECHO	Specifies settings for baud rate, data bits, termination characters, end-of-line delay and echo used by the EDP port.
PRINT	BAUD BITS TERMIN EOLDLY ECHO	Specifies settings for baud rate, data bits, termination characters, end-of-line delay and echo used by the printer port.
STREAM	OFF EDP PRN BOTH	Selects the serial port used for continuous transmission. Streaming can be set for the EDP port, Printer port, or both ports simultaneously. See Section 7.3 on page 46 for information about the <i>420 Plus</i> continuous data format.
STRRTE	INDUST LFT	Specifies stream rate. Stream rate can be set to industrial or legal for trade.
PRNDES	EDP PRN BOTH	Print destination. Selects the EDP port, printer port, or both ports simultaneously for data transmission when the PRINT key is pressed or the KPRINT EDP command is sent.
PRNMSG	OFF ON	Print message. Default will be OFF. When the print key is pressed and data is sent out, the word PRINT is momentarily displayed on the remote display.
<b>Level 3 Submenus</b>		<b>EDP Port and Printer Port</b>
BAUD	9600 300 600 1200 2400 4800 19200 38400	Baud rate. Selects the transmission speed for the EDP or printer port.
BITS	8NONE 7EVEN 7ODD	Selects number of data bits and parity of data transmitted from the EDP or printer port.

Table 3-5. Serial Menu Parameters

SERIAL Menu		
Parameter	Choices	Description
S BITS	1 STOP 2 STOP	Stop bits. Sets the number of stop bits to 1 or 2.
TERMIN	CR/LF CR	Termination character. Selects termination character for data sent from the EDP or printer port.
EOLDLY	000000 <i>number</i>	End-of-line delay. Sets the delay period, in 0.1-second intervals, from when a formatted line is terminated to the beginning of the next formatted serial output. Value specified must be in the range 0-255, in tenths of a second (10 = 1 second).  <div style="display: flex; align-items: center;"> <p><b>Note</b> <i>An EOL may be required for continuous transmission at slower baud rates to ensure the receiving buffer is empty before another string is transmitted</i></p> </div>
ECHO	OFF ON	This command enables or disables echoing of the serial commands sent to the indicator.

Table 3-5. Serial Menu Parameters (Continued)

### 3.2.5 Program Menu

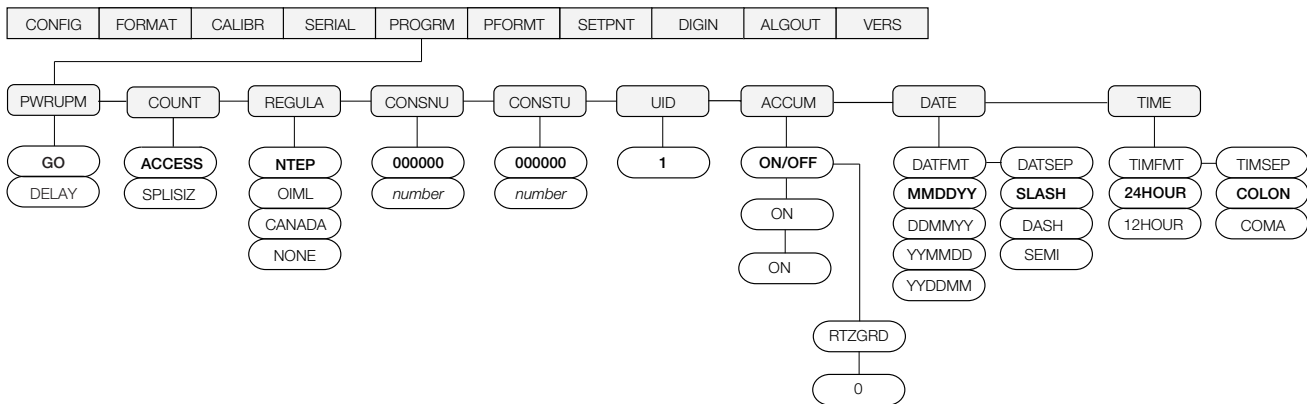

Figure 3-9. Program Menu

PROGRAM Menu		
Parameter	Choices	Description
<b>Level 2 submenus</b>		
PWRUPM	GO DELAY	Power up mode. In GO mode, the indicator goes into operation immediately after a brief power up display test.  In DELAY mode, the indicator performs a power up display test, then enters a 30-second warm up period. If no motion is detected during the warm-up period, the indicator becomes operational when the warm up period ends; if motion is detected, the delay timer is reset and the warm up period repeated.
COUNT	ACCESS SPLISIZ	Specifies whether operator has access to piece count mode and the default sample size used for parts counting. See level three submenu for parameter descriptions.

Table 3-6. Program Menu Parameters

<b>PROGRM Menu</b>		
<b>Parameter</b>	<b>Choices</b>	<b>Description</b>
REGULA	<b>NTEP</b> OIML CANADA NONE	Regulatory mode. Specifies the regulatory agency having jurisdiction over the scale site.  OIML, NTEP, and CANADA modes allow a tare to be acquired at any weight greater than zero. NONE allows tares to be acquired at any weight value.  OIML, NTEP, and CANADA modes allow a tare to be cleared only if the gross weight is at no load. NONE allows tares to be cleared at any weight value.  NTEP and OIML modes allow a new tare to be acquired even if a tare is already present. In CANADA mode, the previous tare must be cleared before a new tare can be acquired.  NONE, NTEP and CANADA modes allow the scale to be zeroed in either gross or net mode as long as the current weight is within the specified ZRANGE. In OIML mode, the scale must be in gross mode before it can be zeroed; pressing the ZERO key in net mode clears the tare.
CONSNU	<b>000000</b> <i>number</i>	Consecutive numbering. Allows sequential numbering for print operations. The consecutive number value is incremented following each print operation.  The initial value of this parameter is set to the start up value specified on the CONSTU parameter. Changing either CONSTU or CONSNU immediately resets the consecutive number used for printing.
CONSTU	<b>000000</b> <i>number</i>	Consecutive number start up value. Specifies the initial consecutive number (CONSNU) value used when the consecutive number is reset by sending CLRCN digital input.
UID	<b>1</b>	Specifies the unit identification number (any numeric value up to six digits).
ACCUM	ON/OFF RTZGRD	Turns the accumulator on and off. Stores the count, date and time of last accumulation. Return to zero grads to re-arm the accumulator. Default = 0.
DATE	DATFMT DATSEP	Allows selection of date format and date separator. See Level three parameter for descriptions.
TIME	TIMFMT TIMSEP	Allows selection of time format and separator. See level three parameter for descriptions.
<b>Level 3 submenus</b>		
ACCESS	<b>DISABLE</b> ENABLE	Operator access to piece count mode. Specify DISABLE if piece count mode will not be used. With access disabled, pressing the GROSS/NET (MODE) key toggles between gross and net modes only.
SPLSIZ	<b>10</b> 20 50 100 5 PCWGT	Sample size. Specify the default size used for counting scale operations. Sample size can be changed in counting mode during sample acquisition.
ON/OFF	<b>ON</b> OFF	Turns the accumulator on and off.
RTZGRD	<b>0</b> Number	This determines the number of grads away from 0 that it has to return to re-arm the accumulator between weighments.
DATFMT	<b>MMDDYY</b> DDMMYY YYMMDD	Specifies the format used to display or print the date.
DATSEP	<b>SLASH</b> DASH SEMI	Specifies the date separator character.
TIMFMT	<b>24HOUR</b> 12HOUR	Specifies the format used to display or print the time.
TIMSEP	<b>COLAN</b> COMMA	Specifies the time separator character.

*Table 3-6. Program Menu Parameters (Continued)*

### 3.2.6 Print Format Menu

See Section 6.0 for information about custom print formatting.

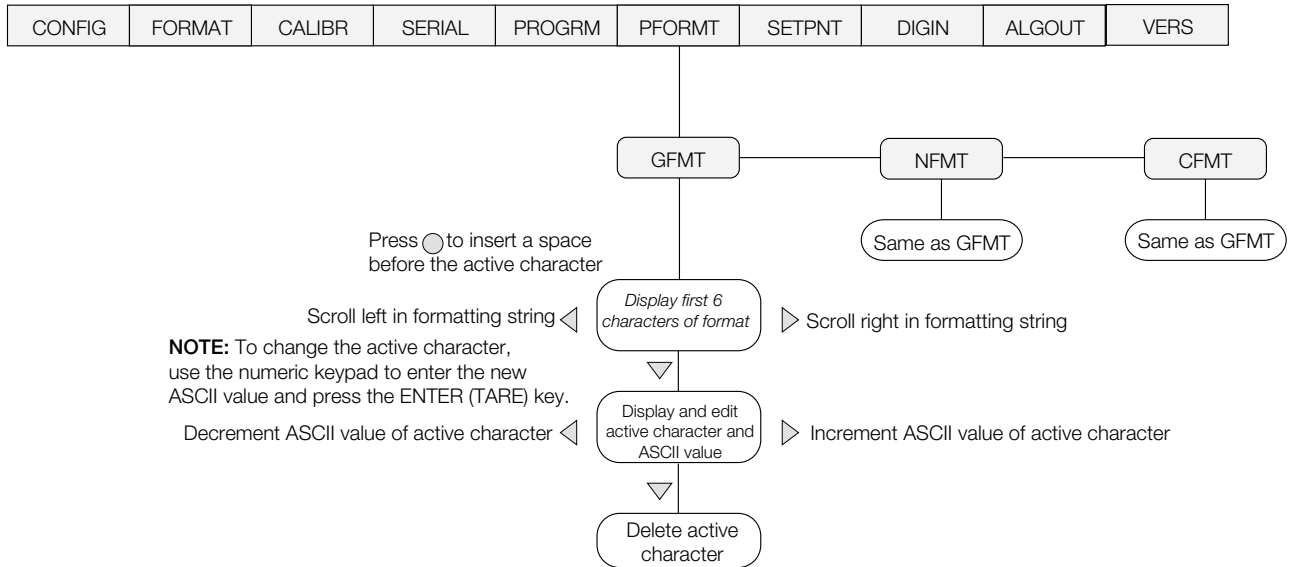

Figure 3-10. Print Format Menu

### 3.2.7 Setpoint Menu

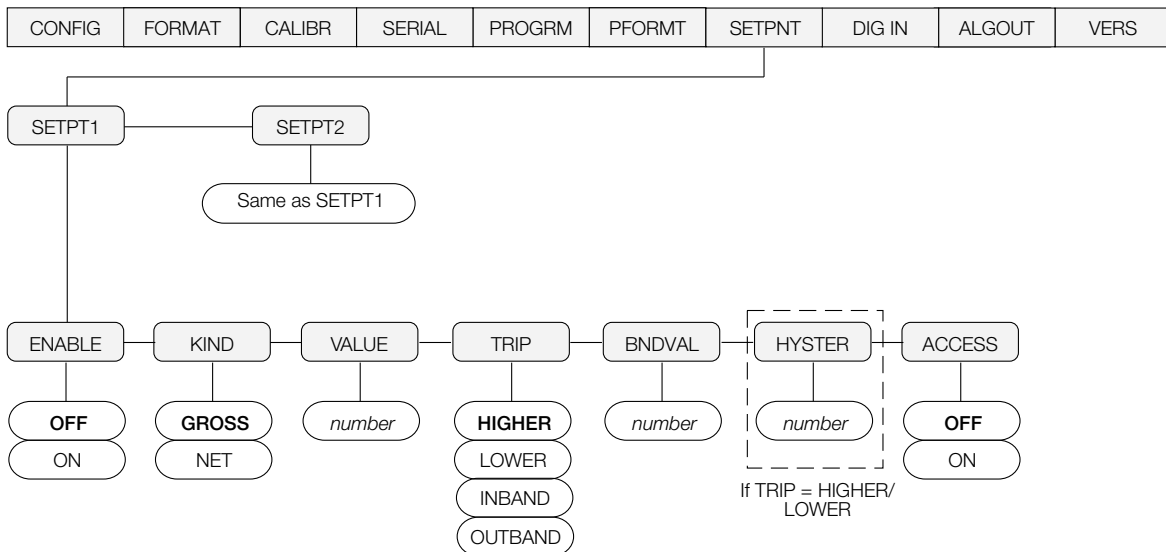

Figure 3-11. Setpoint Menu

<b>SETPNT Menu</b>		
<b>Parameter</b>	<b>Choices</b>	<b>Description</b>
<b>Level 2 submenus</b>		
SETPT1 SETPT2	ENABLE KIND VALUE TRIP BNDVAL	Specify settings for setpoint enable, kind, weight value, trip, and band value used by the setpoint
<b>Level 3 submenus</b>		
ENABLE	<b>OFF</b> ON	Turn setpoint ON or OFF.
KIND	<b>GROSS</b> NET	Specifies the setpoint kind and determines whether function is based on GROSS or NET weight.  GROSS or NET setpoint kinds can be used.
VALUE	number	Display and edit the setpoint value
TRIP	<b>HIGHER</b> LOWER INBAND OUTBND	Trips the setpoint when the weight is higher or lower than the setpoint value, or is within or outside of the band value. LOWER means the output is active until you reach weight. If trip is HIGHER, the output is active when the setpoint is met or exceeded. INBAND means the output is active if the weight is within the band value. If trip is OUTBND, the output is active when the weight is outside of the band value.
BNDVAL	number	The band value for either INBAND or OUTBND trip setpoints. BNDVAL is ignored unless trip is set to INBAND or OUTBND.
HYSTER	number	Specifies a band around the setpoint value that must be exceeded before the setpoint, once off, can trip on.
ACCESS	<b>OFF</b> ON	Front panel access to setpoints. Specify OFF if setpoints will not be used. ON enables operator to turn setpoints on/off, change value, or change BANDVAL via front panel entry during weigh mode.

*Table 3-7. Setpoint Menu Parameters*

### 3.2.8 Digital Input Menu

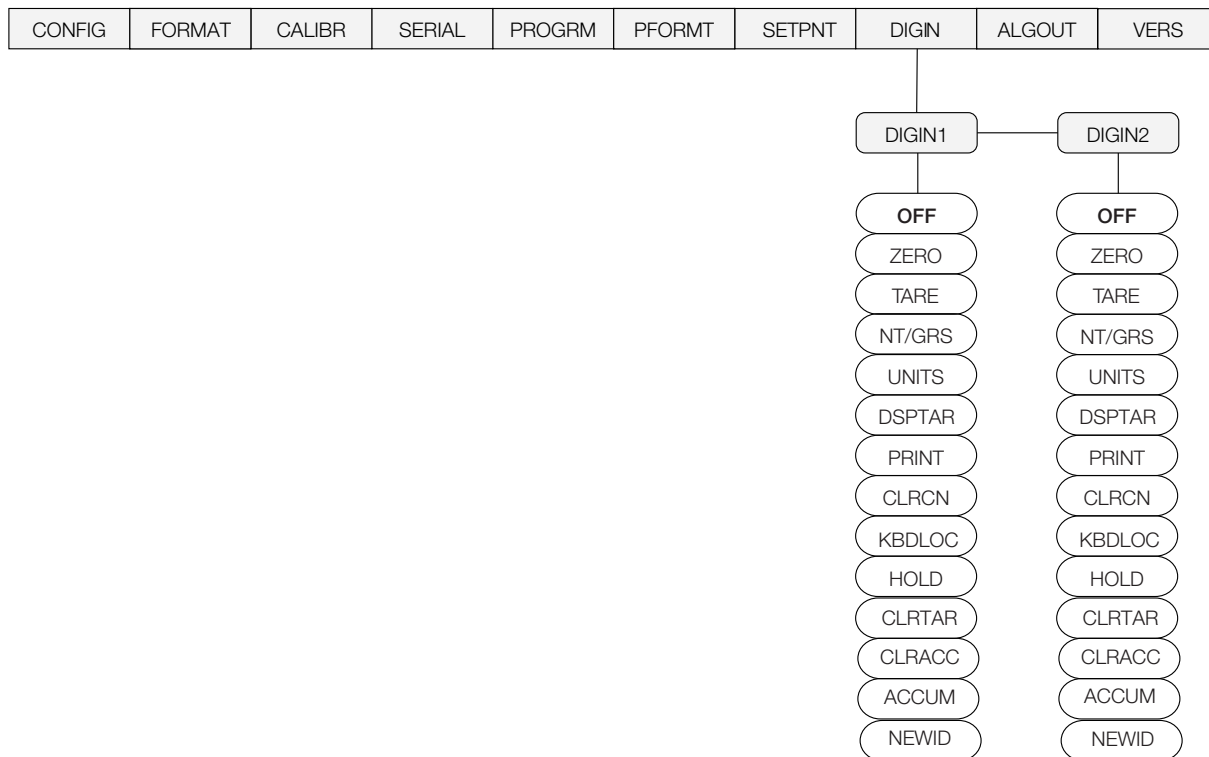

Figure 3-12. Digital Input Menu

DIG IN Menu		
Parameter	Choices	Description
<b>Level 2 submenus</b>		
DIGIN1 DIGIN2	<b>OFF</b> ZERO TARE NT/GRS UNITS DSPTAR PRINT CLRCN KBDLOC HOLD CLRTAR CLRACC ACCUM CLRACC NEWID	Specifies the function activated by digital inputs 1 and 2. <ul style="list-style-type: none"> <li>• ZERO, NT/GRS (net/gross mode toggle), TARE, UNITS, and PRINT provide the same functions as the front panel keys.</li> <li>• DSPTAR displays the current tare value.</li> <li>• CLRCN resets the consecutive number to the value specified on the CONSTU parameter (PROGRAM menu).</li> <li>• KBDLOC disables the keypad while the digital input is held low.</li> <li>• HOLD holds the current display. Releasing this input clears the running average filter.</li> <li>• CLRTAR clears the tare.</li> <li>• ACCUM displays the accumulator.</li> <li>• CLRACC clears the accumulator.</li> <li>• NEWID enters the ID number.</li> </ul>

Table 3-8. Digital Input Menu Parameters

### 3.2.9 Analog Output Menu

The ALGOUT menu is used only if the analog output option is installed. If the analog output option is installed, configure all other indicator functions and calibrate the indicator (see Section 4.0) before configuring the analog output. See Section 7.8 on page 52 for analog output calibration procedures.

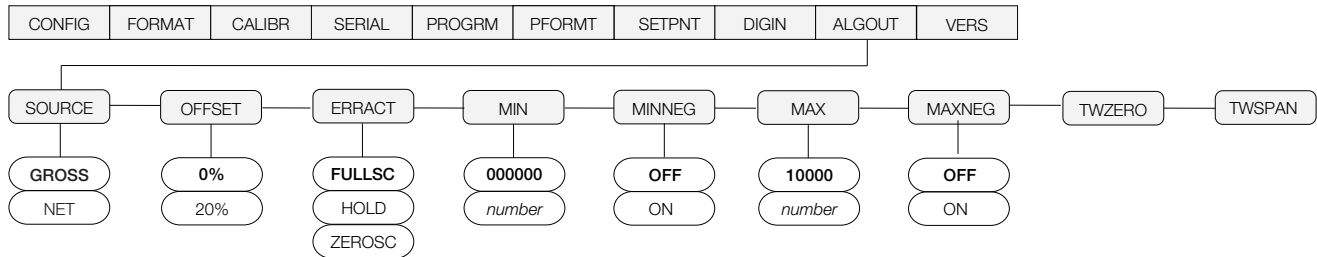

Figure 3-13. Analog Output Menu

ALG OUT Menu		
Parameter	Choices	Description
<b>Level 2 submenus</b>		
SOURCE	<b>GROSS</b> NET	Specifies the source tracked by the analog output.
OFFSET	<b>0%</b> 20%	Zero offset. Selects whether the analog output supplies voltage (0–10 V) or current (4–20 mA) output. Select 0% for 0–10 V output; select 20% for 4–20 mA output.
ERRACT	<b>FULLSC</b> HOLD ZEROSC	Error action. Specifies how the analog output responds to system error conditions.  Possible values are:  FULLSC     Set to full value (10 V or 20 mA) HOLD:     Hold current value ZEROSC:    Set to zero value (0 V or 4 mA)
MIN	<b>000000</b> number	Specifies the minimum weight value tracked by the analog output. Specify a weight value (in primary units) in the range 0–999 999.
MINNEG	<b>OFF</b> ON	Turn ON or OFF.
MAX	<b>010000</b> number	Specifies the maximum weight value tracked by the analog output. Specify a weight value (in primary units) in the range 0–999 999.
MAXNEG	<b>OFF</b> ON	Turn ON or OFF.
TWZERO	—	Tweak zero. Adjust the analog output zero calibration. Use a multimeter to monitor the analog output value. Press and hold $\Delta$ or $\nabla$ to adjust the output. Press $\bigcirc$ to save the new value.
TWSPAN	—	Tweak span. Adjust the analog output span calibration. Use a multimeter to monitor the analog output value. Press and hold $\Delta$ or $\nabla$ to adjust the output. Press $\bigcirc$ to save the new value.

Table 3-9. Analog Output Menu Parameters

### 3.2.10 Version Menu

The VERS menu is used to check the software version and reg version installed in the indicator. You can also check the indicator model.

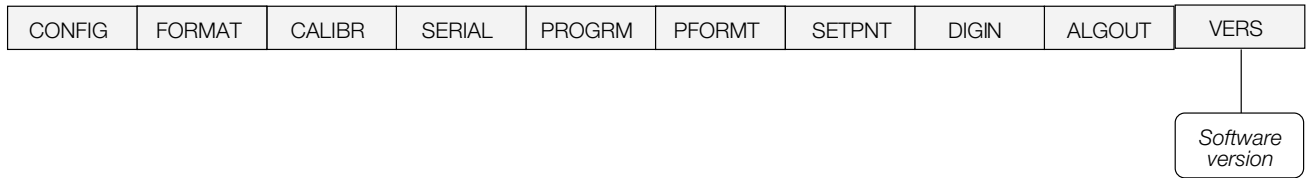

*Figure 3-14. Version Menu*

## 4.0 Calibration

The 420 Plus can be calibrated using the front panel, EDP commands, or the *Revolution*<sup>®</sup> configuration utility. Each method consists of the following steps:

- Zero calibration
- Entering the test weight value
- Span calibration
- Optional rezero calibration for test weights using hooks or chains.

The following sections describe the calibration procedure for each of the calibration methods.

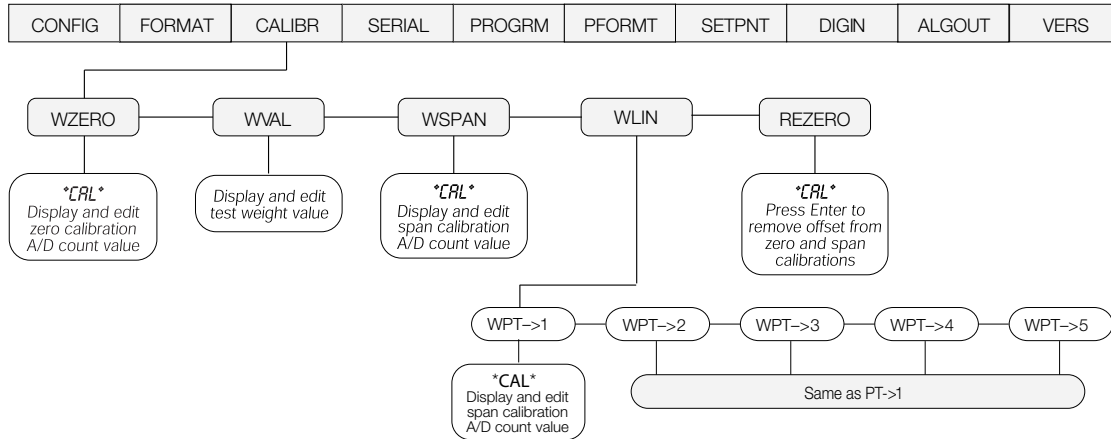

Figure 4-1. Calibration (CALIBR) Menu

### 4.1 Front Panel Calibration

To calibrate the indicator using the front panel,

1. Place the indicator in setup mode (display reads *CONFIG*) and remove all weight from the scale platform. If your test weights require hooks or chains, place the hooks or chains on the scale for zero calibration.
2. Press  $\blacktriangleright$  until the display reads *CALIBR* (see Figure 4-1). Press  $\nabla$  to go to zero calibration (*WZERO*).
3. With *WZERO* displayed, press  $\bigcirc$  to calibrate zero. The indicator displays *\*CAL\** while calibration is in progress. When complete, the A/D count for the zero calibration is displayed. *DO NOT adjust this value after WSPAN has been set!* Press  $\bigcirc$  again to save the zero calibration value and go to the next prompt (*WWAL*).
4. With *WWAL* displayed, press  $\bigcirc$  to show the stored calibration weight. Use the procedure shown in Figure 3-4 on page 19 to enter the actual value of the test weights to be used for the span calibration. Press  $\bigcirc$  to store the entered *WWAL* value and go to span calibration (*WSPAN*).
5. With *WSPAN* displayed, place test weights on the scale and press  $\bigcirc$  to calibrate span. The indicator displays *\*CAL\** while calibration is in progress. When complete, the A/D count for the span calibration is displayed. Press  $\bigcirc$  again to store the span calibration value and go to the

next prompt (*REZERO*).

6. Five-point linearization (using the *WLIN* parameter) provides increased scale accuracy by calibrating the indicator at up to five additional points between the zero and span calibrations.

Linearization is optional: if you choose not to perform linearization, skip the *WLIN* parameter; if linearization values have previously been entered, these values are reset to zero during calibration. To perform linearization, follow the procedure below:

**Standard Calibration:** With *WLIN* displayed, Press  $\nabla$  to go to the first linearization point (*PT-> 1*). Place test weights on the scale and press  $\bigcirc$  or **ENTER**.

Enter the actual test weight value, then press  $\bigcirc$  to calibrate. The indicator displays *\*CAL\** while calibration is in progress. When complete, the A/D count for the linear calibration is displayed. Press  $\bigcirc$  again to save the calibration value and go to the next prompt (*PT-> 2*).

Repeat for up to five linearization points. To exit the linearization parameters, press  $\triangle$  to return to *WLIN*.

**Millivolt Calibration:** If millivolt calibration is enabled press  $\bigcirc$  to display and edit the test weight value, press  $\bigcirc$  again to display and edit the millivolt value for that weight, press  $\bigcirc$  again to calibrate and display the raw A/D count, press  $\bigcirc$  again to move to the next calibration point.

7. The rezero function is used to remove a calibration offset when hooks or chains are used to hang the test weights.
  - If no other apparatus was used to hang the test weights during calibration, remove the test weights and press  $\Delta$  to return to the CALIBR menu.
  - If hooks or chains were used during calibration, remove these and the test weights from the scale. With all weight removed, press  $\bigcirc$  to rezero the scale. This function adjusts the zero and span calibration values. The indicator displays \*CAL\* while the zero and span calibrations are adjusted. When complete, the adjusted A/D count for the zero calibration is displayed. Press  $\bigcirc$  to save the value, then press  $\Delta$  to return to the CALIBR menu.
8. Press  $\triangleleft$  until the display reads CONFIG, then press  $\Delta$  to exit setup mode.

## 4.2 EDP Command Calibration

To calibrate the indicator using EDP commands, the indicator EDP port must be connected to a terminal or personal computer. See Section 2.3.5 on page 12 for EDP port pin assignments; see Section 5.0 on page 35 for more information about using EDP commands.

Once the indicator is connected to the sending device,

1. Place the indicator in setup mode (display reads CONFIG) and remove all weight from the scale platform. If your test weights require hooks or chains, place them on the scale for zero calibration.
2. Send the WZERO EDP command to calibrate zero. The indicator displays \*CAL\* while calibration is in progress.
3. Place test weights on the scale and use the WVAL command to enter the test weight value in the following format:  
WVAL=nnnnnn<CR>
4. Send the WSPAN EDP command to calibrate span. The indicator displays \*CAL\* while calibration is in progress.
5. Up to five linearization points can be calibrated between the zero and span calibration values. Use the following commands to set and calibrate a single linearization point:  
WLIN.V1=nnnnn<CR>  
WLIN.C1<CR>

The WLIN.V1 command sets the test weight value (nnnnn) for linearization point 1. The WLIN.C1 command calibrates the point. Repeat using the WLIN.Vx and WLIN.Cx commands as required for additional linearization points.

6. To remove an offset value, clear all weight from the scale, including items used to hang test weights, then send the REZERO EDP command. The indicator displays \*CAL\* while the zero and span calibrations are adjusted.
7. Send the KUPARROW EDP command to exit setup mode.

## 4.3 Revolution Calibration

To calibrate the indicator using *Revolution*, the indicator EDP port must be connected to a PC running the *Revolution* configuration utility.

Use the following procedure to calibrate the indicator:

1. Select *Calibration Wizard* from the *Revolution* tools menu.
2. *Revolution* uploads calibration data from the indicator then presents the information in the calibration wizard, as shown in Figure 4-2



Figure 4-2. Revolution Calibration Display

3. Enter the *Value of Test Weight* to be used for span calibration then click *OK*.
4. The Zero Calibration dialog box prompts you to remove all weight from the scale. Clear the scale and click *OK* to begin zero calibration.



**Note** If your test weights require hooks or chains, place them on the scale for zero calibration.

5. When zero calibration is complete, the Span Calibration dialog box prompts you to place test weights on the scale for span calibration. Place test weights on the scale then click *OK*.

6. When span calibration is complete, a dialog box asks whether you wish to perform linear calibration. Click *Yes* to perform linear calibration for up to five linearization points, or click *No* to complete calibration (see step 8).
7. On the Linear Calibration display, select the point (1–5) to calibrate, then click *Calibrate*. Place test weights on scale then click *OK*. When prompted, enter the test weight value then press *Enter*. Repeat for additional linearization points, then click *Exit* to return to the Indicator Calibration display.
8. When calibration is complete, the *New Settings* fields of the Indicator Calibration display are filled in. Click *Exit* to save the new values and return to the *Revolution* main menu; to restore the previous calibration values, click *Restore Settings*.

## 4.4 More About Calibration

The following topics provide additional information about compensating for environmental factors (Section 4.4.1) and diagnostic information for determining expected zero and span coefficients.

### 4.4.1 Adjusting Final Calibration

Calibration may be affected by environmental factors including wind, vibration, and angular loading. For example, if the scale is calibrated with 1000 lb, a strain test may determine that at 2000 lb the calibration is 3 lb high. In this case, final calibration can be adjusted by tweaking *WVAL* to 998.5 lb. This adjustment provides a linear correction of 1.5 lb per 1000 lb.

To adjust the final calibration, return to the *WVAL* prompt and press  $\odot$  to show the test weight value. Press  $\triangle$  or  $\nabla$  to adjust calibration up or down. Press  $\odot$  to save the value, then press  $\triangle$  to return to the *CALIBR* menu.

### 4.4.2 Zero Deadload A/D Counts

Table 4-1 lists the ideal A/D counts that result from input signals of 0–3.0 mV with zero deadload. Actual values will typically be higher than the values shown in Table 4-1 but the ideal values can be used when calibrating the indicator with no attached scale.

Input Signal (mV)	Raw A/D Counts
0.0 mV/V	167,840
0.5 mV/V	335,613
1.0 mV/V	503,377
1.5 mV/V	671,143
2.0 mV/V	838,908
2.5 mV/V	1,100,668
3.0 mV/V	1,174,446

Table 4-1. Ideal A/D Raw Counts



**Note**

When Raw A/D Count is displayed, the six most significant digits appear. Scroll left or right to see the full value.

## 5.0 EDP Commands

The 420 Plus indicator can be controlled by a personal computer or remote keyboard connected to the indicator EDP port. Control is provided by a set of EDP commands that can simulate front panel key press functions, display and change setup parameters, and perform reporting functions. The EDP port provides the capability to print configuration data or to save that data to an attached personal computer. This section describes the EDP command set and procedures for saving and transferring data using the EDP port.

### 5.1 The EDP Command Set

The EDP command set can be divided into five groups: key press commands, reporting commands, the RESETCONFIGURATION special function command, parameter setting commands, and transmit weight data commands.

When the indicator processes an EDP command, it responds with the message *OK*. The *OK* response verifies that the command was received and has been executed. If the command is unrecognized or cannot be executed, the indicator responds with *??*.

The following sections list the commands and command syntax used for each of these groups.

#### 5.1.1 Key Press Commands

Key press EDP commands (see Table 5-1) simulate pressing the keys on the front panel of the indicator. Most commands can be used in both setup and weighing mode. Several of the commands serve as “pseudo” keys, providing functions that are not represented by a key on the front panel.

For example, to enter a 15-pound tare weight using EDP commands:

1. Type K1 and press **ENTER** (or **RETURN**).
2. Type K5 and press **ENTER**.
3. Type KTARE and press **ENTER**. The display shifts to net mode when the tare is entered.

Command	Function
KZERO	In weighing mode, press the ZERO key
KGROSSNET	In weighing mode, press the GROSS/NET key
KGROSS	Go to gross mode (pseudo key)
KNET	Go to net mode (pseudo key)
KTARE	Press the TARE key
KUNITS	In weighing mode, press the UNITS key
KPRIM	Go to primary units (pseudo key)
KSEC	Go to secondary units (pseudo key)
KPRINT	In weighing mode, press the PRINT key
KLEFTARROW	In setup mode, move left in the menu
KRIGHTARROW	In setup mode, move right in the menu
KUPARROW	In setup mode, move up in the menu
KDOWNARROW	In setup mode, move down in the menu
KEXIT	In setup mode, exits to normal mode
KCOUNT	Go to piece count mode (pseudo key)
KTIME	Press the TIME/DATE key once
KDATE	Press the TIME/DATE key twice
KDISPTARE	Press the DISPLAY TARE key
KDISPACCUM	Displays accumulator
KCLRACCUM	Clears accumulator
KCLR	Press the CLEAR key
K0	Press number 0 (zero)
K1	Press number 1
K2	Press number 2
K3	Press number 3
K4	Press number 4
K5	Press number 5
K6	Press number 6
K7	Press number 7
K8	Press number 8
K9	Press number 9
KDOT	Press the decimal point (.)
KENTER	Press the ENTER key

Table 5-1. EDP Key Press Commands

### 5.1.2 Reporting Commands

Reporting commands (see Table 5-2) send specific information to the EDP port. These commands can be used in both setup mode and normal mode.

Command	Function
DUMPALL	List all parameter values
VERSION	Write <i>420 Plus</i> software version
P	Write current displayed weight with units identifier. See Section 7.2 on page 45 for more information.
ZZ	Write current weight and annunciator status. See Section 7.2 on page 45 for more information.
S	Write one frame of stream format. See Table 5-12 on page 39 for information about the SX and EX commands.

Table 5-2. EDP Reporting Commands

### 5.1.3 The RESETCONFIGURATION Command

The RESETCONFIGURATION command can be used to restore all configuration parameters to their default values. Before issuing this command, the indicator must be placed in test mode (press and hold setup switch for approximately three seconds to show TEST menu).

This command is equivalent to using the DEFLT function on the TEST menu. See Section 7.9 on page 53 for more information about test mode and using the TEST menu.



**Note** All load cell calibration settings are lost when the RESETCONFIGURATION command is run.

### 5.1.4 Parameter Setting Commands

Parameter setting commands allow you to display or change the current value for a particular configuration parameter (Tables 5-3 through 5-11).

Current configuration parameter settings can be displayed in either setup mode or normal mode using the following syntax:

`command<ENTER>`

Most parameter values can be changed in setup mode only. Use the following command syntax when changing parameter values:

`command=value<ENTER>`

where *value* is a number or a parameter value. Use no spaces before or after the equal (=) sign. If you type an incorrect command or value, the display reads??. Changes to the parameters are saved as they are entered but typically do not take effect until you exit setup mode.

For example, to set the motion band parameter to 5, type the following:

`MOTBAND=5D<ENTER>`

To view choices, type the following:

`MOTBAND=?<ENTER>`

### 5.1.5 Soft Reset

The command RS will reset the indicator without losing configuration and calibration. It does reset consecutive number and count mode.

Command	Description	Values
GRADS	Graduations	1–100 000
ZTRKBD	Zero track band	OFF, 0.5D, 1D, 3D
ZRANGE	Zero range	1.9%, 100%
MOTBAND	Motion band	1D, 2D, 3D, 5D, 10D, 20D, OFF
OVRLOAD	Overload	FS+2%, FS+1D, FS+9D, FS
SMPRAT	Sample rate	15HZ, 30HZ, 60HZ, 7.5HZ
DIGFLTR1 DIGFLTR2 DIGFLTR3	Digital filtering	1, 2, 4, 8, 16, 32, 64
DFSENS	Digital filter cutout sensitivity	2OUT, 4OUT, 8OUT, 16OUT, 32OUT, 64OUT, 128OUT
DFTHRH	Digital filter cutout threshold	NONE, 2DD, 5DD, 10DD, 20DD, 50DD, 100DD, 200DD, 250DD
TAREFN	Tare function	BOTH, NOTARE, PBTARE, KEYED

Table 5-3. CONFIG EDP Commands

Command	Description	Values
PRI.DECPNT	Primary units decimal position	8.88888, 88.8888, 888.888, 8888.88, 88888.8, 888888, 888880
PRI.DSPDIV	Primary units display divisions	1D, 2D, 5D
PRI.UNITS	Primary units	LB, KG, OZ, TN, T, G, NONE
SEC.DECPNT	Secondary units decimal position	8.88888, 88.8888, 888.888, 8888.88, 88888.8, 888888, 888880
SEC.DSPDIV	Secondary units display divisions	1D, 2D, 5D
SEC.UNITS	Secondary units	LB, KG, OZ, TN, T, G, NONE
SEC.MULT	Secondary units multiplier	0.00000–9999.99
DSPRATE	Display rate	250MS, 500MS, 750MS, 1SEC, 1.5SEC, 2SEC, 2.5SEC, 3SEC, 4SEC, 6SEC, 8SEC

Table 5-4. *FORMAT EDP Commands*

Command	Description	Values
WZERO	Zero calibration	–
WVAL	Test weight value	<i>test_weight_value</i>
WSPAN	Span calibration	–
REZERO	Rezero	–
LC.CD	Set deadload coefficient	<i>value</i>
LC.CW	Set span coefficient	<i>value</i>

Table 5-5. *CALIBR EDP Commands*

Command	Description	Values
EDP.BAUD	EDP port baud rate	300, 600, 1200, 2400, 4800, 9600, 19200, 38400
EDP.BITS	EDP port data bits/parity	8NONE, 7EVEN, 7ODD
EDP.TERMIN	EDP port termination character	CR/LF, CR
EDP.EOLDLY	EDP port end-of-line delay	0–255 (0.1-second intervals)
EDP.ECHO	EDP port echo	ON, OFF
PRN.BAUD	Printer port baud rate	300, 600, 1200, 2400, 4800, 9600, 19200, 38400
PRN.BITS	Printer port data bits/parity	8NONE, 7EVEN, 7ODD
PRN.TERMIN	Printer port termination character	CR/LF, CR
PRN.EOLDLY	Printer port end-of-line delay	0–255 (0.1-second intervals)
PRN.ECHO	Printer port echo	ON, OFF
STREAM	Streaming port	OFF, EDP, PRN
STRRTE	Stream rate	INDUST, LFT
PRNDEST	Print destination	EDP, PRN
PRNMSG	Print message	OFF, ON

Table 5-6. *SERIAL EDP Commands*

Command	Description	Values
PWRUPMD	Power up mode	GO, DELAY
CNTMOD	Counting Mode	ENABLE, DSABLE, SPLSIZ
REGULAT	Regulatory compliance	NTEP, OIML, CANADA, NONE
SPLSIZ	Sample size	10, 20, 50, 100, 5, PCWGT
CONSNUM	Consecutive number	0-999 999
CONSTUP	Consecutive number start-up value	0-999 999
DATEFMT	Date format	MMDDYY, DDMMYY, YYMMDD, YYDDMM
DATESEP	Date separator	SLASH, DASH, SEMI
TIMEFMT	Time format	12HOUR, 24HOUR
TIMESEP	Time separator	COLON, COMMA
ACCUM	Accumulator	ON/OFF
ACCUM. RTZGRADS	Return to zero trigger	0 - 10,000 GRADS

Table 5-7. PROGRM EDP Commands

Command	Description	Values
GFMT	Gross demand print format string	See Section 6.0 on page 41 for detailed information
NFMT	Net demand print format string	
CFMT	Count demand print format string	

Table 5-8. PFORMT EDP Commands

Command		Description	Values
SP1	SP2		
SP1.ENABLE	SP2.ENABLE	Setpoint enable	OFF, ON
SP1.KIND	SP2.KIND	Setpoint kind	GROSS, NET
SP1.VALUE	SP2.VALUE	Setpoint value	number
SP1.TRIP	SP2.TRIP	Trip	Higher, Lower, Inband, Outbnd
SP1.BNDVAL	SP2.BNDVAL	Band value	number
SP1.HYSTER	SP2.HYSTER	Hysteresis	number
SP1.ACCESS	SP2.ACCESS	Setpoint access	OFF, ON

Table 5-9. SETPNTS EDP Commands

Command	Description	Values
DIGIN1 DIGIN2	Digital input function	OFF, ZERO, TARE, NT/GRS, UNITS, DSPTAR, PRINT, CLRON, KBDLOC, HOLD, CLRTAR, ACCUM, CLRACC, NEWID

Table 5-10. DIG IN EDP Commands

Command	Description	Values
SOURCE	Analog output source	GROSS, NET
OFFSET	Zero offset	0%, 20%
ERRACT	Error action	FULLSC, HOLD, ZEROSC
MIN	Minimum value tracked	0-999 999
MINNEG	Minimum negative	OFF, ON
MAX	Maximum value tracked	0-999 999
MAXNEG	Maximum negative	OFF, ON
TWZERO	Zero calibration	0-16 383
TWSPAN	Span calibration	0-16 383

Table 5-11. ALGOUT EDP Commands

### 5.1.6 Normal Mode Commands

The serial transmit weight data commands (see Table 5-12) transmit data to the EDP port on demand. The SX and EX commands are valid only in normal operating mode; all other commands are valid in either setup or normal mode.

Command	Description	Response Format
UID	Set unit ID	nnnnnnn
SD	Set date	MMDDYY, DDMMYY, YYMMDD (enter using DATEFMT specified)
ST	Set time	hhmm (enter using 24-hour format)
SX	Start EDP streaming	OK or ??
EX	Stop EDP streaming	OK or ??
RS	Reset system	—
XA	Transmit accumulator value	nnnnnn UU
XG	Transmit gross weight in displayed units	where nnnnnn is the weight value, UU is the units.
XN	Transmit net weight in displayed units	
XT	Transmit tare weight in displayed units	
XG2	Transmit gross weight in non-displayed units	
XN2	Transmit net weight in non-displayed units	
XT2	Transmit tare weight in non-displayed units	
XW	Transmit current piece weight	nnnnnn UU
XC	Transmit current part count	nnnnnn PC
XE	Query system error conditions	nnnnn nnnnn See Section 7.1.2 on page 45 for detailed information about the XE command response format.

Table 5-12. Normal Mode Commands

## 5.2 Saving and Transferring Data

Connecting a personal computer to the *420 Plus* EDP port allows you to save indicator configuration data to the PC or to download configuration data from the PC to an indicator. The following sections describe the procedures for these save and transfer operations.

### 5.2.1 Saving Indicator Data to a Personal Computer

Configuration data can be saved to a personal computer connected to the EDP port. The PC must be running a communications program such as PROCOMMPLUS®. See Section 2.3.5 on page 12 for information about serial communications wiring and EDP port pin assignments.

When configuring the indicator, ensure that the values set for the BAUD and BITS parameters on the SERIAL menu match the baud rate, bits, and parity settings configured for the serial port on the PC. Set the PRNDEST parameter to EDP.

To save all configuration data, place the indicator in setup mode and send the DUMPALL EDP command to the indicator. The *420 Plus* responds by sending all configuration parameters to the PC as ASCII-formatted text.

### 5.2.2 Downloading Configuration Data from PC to Indicator

Configuration data saved on a PC or floppy disk can be downloaded from the PC to an indicator. This procedure is useful when a number of indicators with similar configurations are set up or when an indicator is replaced.

To download configuration data, connect the PC to the EDP port as described in Section 5.2.1. Place the indicator in setup mode and use the PC communications software to send the saved configuration data to the indicator. When transfer is complete, calibrate the indicator as described in Section 4.0.



#### Note

*Calibration settings are included in the configuration data downloaded to the indicator. If the receiving indicator is a direct replacement for another *420 Plus* and the attached scale is not changed, recalibration is not required.*

*When downloading configurations that include changed serial communications settings, edit the data file to place the serial communications changes at the end of the file. Communication between the PC and indicator will be lost once the indicator receives settings for baud rate (BAUD parameter) or data bits and parity (BITS parameter) that do not match those configured for the PC.*

## 6.0 Print Formatting

The 420 Plus provides three print formats, GFMT, NFMT, and CFMT that determine the format of the printed output when the PRINT key is pressed or when a KPRINT EDP command is received. If a tare has been entered or acquired, NFMT is used; otherwise, GFMT is used.

Each print format can be customized to include up to 300 characters of information, such as company name and address, on printed tickets. You can use the indicator front panel (PFORMAT menu), EDP commands, or the Revolution® configuration utility to customize the print formats.



**Note** Display will only show capital letters, press the down arrow to view the ASCII character decimal value on the second menu level. Refer to Table 7-4 on page 47 and Table 7-5 on page 48 to view the ASCII character charts.

### 6.1 Print Formatting Commands

Table 6-1 lists commands you can use to format the gross, net and count print formats. Commands included in the format strings must be enclosed between < and > delimiters. Any characters outside of the delimiters are printed as text on the ticket. Text characters can include any ASCII character that can be printed by the output device.

Command	Description
<G>	Gross weight in displayed units
<G2>	Gross weight in non-displayed units
<N>	Net weight in displayed units
<N2>	Net weight in non-displayed units
<T>	Tare weight in displayed units
<T2>	Tare weight in non-displayed units
<A>	Accumulated weight in displayed units
<AC>	Number of accumulator events (5-digit counter)
<AD>	Date of last accumulator event
<AT>	Time of last accumulator event
<UID>	Unit ID number
<CN>	Consecutive number
<NL $nn$ >	New line ( $nn$ = number of termination (<CR/LF> or <CR>) characters)*
<C>	Current piece count
<W>	Current piece weight
<SP $nn$ >	Space ( $nn$ = number of spaces)*
<SU>	Toggle weight data format (formatted/unformatted)**
<TI>	Time

Table 6-1. Print Format Commands

Command	Description
<DA>	Date
<TD>	Time & Date
	Gross, net, and tare weights are 9 digits in length, including sign (10 digits with decimal point), followed by a space and a two-digit units identifier. Total field length with units identifier is 12 (or 13) characters.
	ID and consecutive number (CN) fields are 1–6 characters in length, as required.
	* If $nn$ is not specified, 1 is assumed. Value must be in the range 1–99.
	** After receiving an SU command, the indicator sends unformatted data until the next SU command is received. Unformatted data omits decimal points, leading and trailing characters.

Table 6-1. Print Format Commands

The default GFMT, NFMT and CFMT print formats use only the new line (<NL>) command and the commands for gross, net, and tare weights in displayed units (<G>, <N>, and <T>). The default 420 Plus print formats are shown in Table 6-2:

Format	Default Format String	Sample Output
GFMT	<G> GROSS<NL>	2046.81 lb GROSS
NFMT	<G> GROSS<NL> <T> TARE<NL> <N> NET<NL>	4053.1 lb GROSS 15.6 lb TARE 4037.5 lb NET
CFMT	<C><NL>	512 PC

Table 6-2. GFMT and NFMT Formats



**Note** The <G2>, <N2>, and <T2> commands listed in Table 6-1 print the gross, net, and tare weights in non-displayed units—that is, in the units not currently displayed on the indicator.

ID numbers included in the print format string (<UID> command) must be set using the UID EDP command.

The 300-character limit of each print format string includes the output field length of the print formatting commands, not the command length. For example, if the indicator is configured to show a decimal point, the <G> command generates an output field of 13 characters: the 10-character weight value (including decimal point), one space, and a two-digit units identifier.

PT (preset tare) is added to the tare weight if tare was keyed in.

## 6.2 Customizing Print Formats

The following sections describe procedures for customizing the GFMT, NFMT and CFMT formats using the EDP port, the front panel (PFORMT menu), and the *Revolution* configuration utility.

### 6.2.1 Using the EDP Port

With a personal computer, terminal, or remote keyboard attached to the *420 Plus* EDP port, you can use the EDP command set to customize the print format strings.

To view the current setting of a format string, type the name of the string (GFMT, NFMT or CFMT) and press **ENTER**. For example, to check the current configuration of the GFMT format, type GFMT and press **ENTER**. The indicator responds by sending the current configuration for the gross format:

```
GFMT=<G> GROSS<NL>
```

To change the format, use the GFMT, NFMT or CFMT EDP command followed by an equals sign (=) and the modified print format string. For example, to add the name and address of a company to the gross format, you could send the following EDP command:

 **Note** Indicator must be placed in the setup mode, CONFIG is shown on the display.

```
GFMT=FINE TRANSFER CO<NL>32400 WEST  
HIGHWAY ROAD<NL>SMALLTOWN<NL2><G>  
GROSS<NL>
```

A ticket printed using this format might look like the following:

```
FINE TRANSFER CO  
32400 WEST HIGHWAY ROAD  
SMALLTOWN
```

```
1345 lb GROSS
```

### 6.2.2 Using the Front Panel

If you have no access to equipment for communication through the EDP port or are working at a site where such equipment cannot be used, you can use the PFORMT menu (see Figure 6-1) to customize the print formats.

Using the PFORMT menu, you can edit the print format strings by changing the decimal values of the ASCII characters in the format string.

 **Note** Lowercase letters and some special characters cannot be displayed on the *420 Plus* front panel (see the ASCII character charts on page 47 and page 48) and are shown as blanks. The *420 Plus* can send or receive any ASCII character; the character printed depends on the particular ASCII character set implemented for the receiving device.

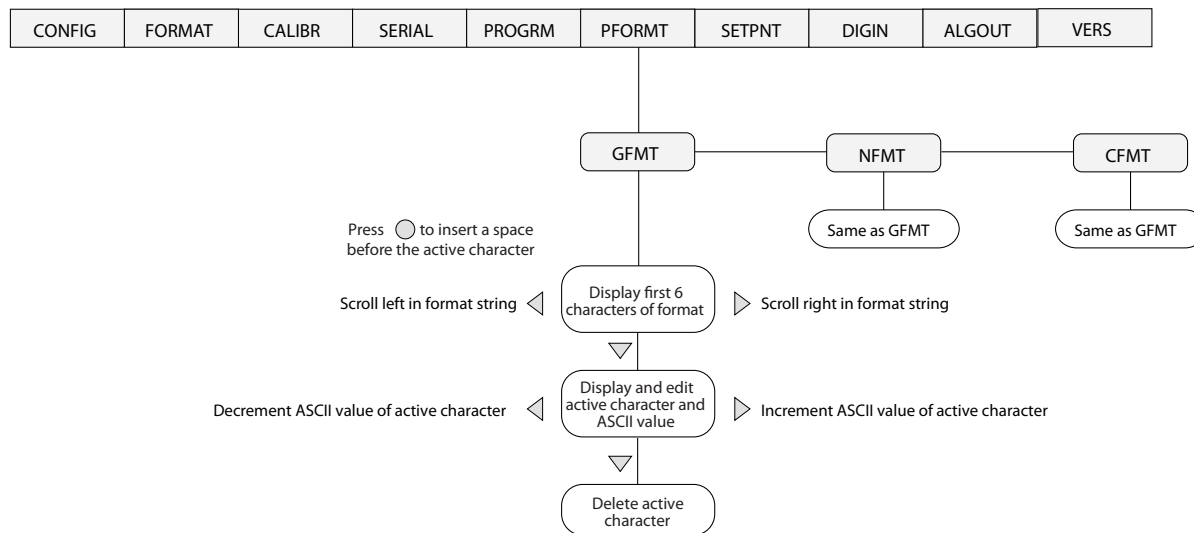

Figure 6-1. PFORMT Menu, Showing Alphanumeric Character Entry Procedure

### 6.2.3 Using Revolution

The *Revolution* configuration utility provides a print formatting grid with a tool bar. The grid allows you to construct the print format without the formatting commands (<NL> and <SP>) required by the front panel or EDP command methods. Using *Revolution*, you can type text directly into the grid, then select weight value fields from the tool bar and place them where you want them to appear on the printed ticket.

Figure 6-2 shows an example of the *Revolution* print formatting grid.

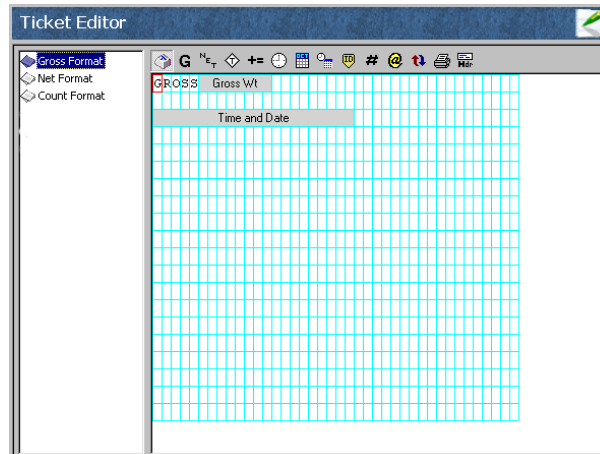

Figure 6-2. Revolution Print Format Grid

# 7.0 Appendix

## 7.1 Error Messages

The 420 Plus indicator provides a number of error messages. When an error occurs, the message is shown on the indicator LED display. Error conditions can also be checked remotely by using the XE EDP command as described in Section 7.1.2 on page 45.

### 7.1.1 Displayed Error Messages

The 420 Plus provides a number of front panel error messages to assist in problem diagnosis. Table 7-1 lists these messages and their meanings.

Error Message	Description	Solution
E A/D	A/D physical error	Call Rice Lake Weighing Systems (RLWS) Service.
VIREE	Virgin EEPROM	Use TEST menu to perform DEFLT (restore defaults) procedure, then recalibrate load cells.
EPCKSM	Parameter checksum error	
ADCKSM	A/D calibration checksum error	A/D converter requires recalibration. Call RLWS Service.
PFCKSM	Printer format checksum error	Call RLWS Service.
LCCKSM	Load cell calibration checksum error	Recalibrate load cells.
EIDATA	Internal RAM checksum error	Call RLWS Service.
E REF	A/D reference error	A/D converter requires recalibration. Call RLWS Service.
ERROR	Internal program error	Check configuration. Run XE command (see Section 7.1.2 on page 45) to determine error type. Call RLWS Service if unable to clear error by cycling power or if error recurs.
OVERFL	Overflow error	Weight value too large to be displayed.
-----	Gross > overload limit	Gross value exceeds overload limit. Check configuration or signal input level. Overload can be caused by input signal > 45 mV or common mode voltage > 950 mV.
_____	A/D underrange	A/D reading < -4 mV. Check scale for binding or damage.
RNGERR	GRADS > 100,000 WVAL > 100,000	Only shows up in Config mode.
CNTERR	Count error, insufficient sample size	Reconfigure, parts sample too small for current configuration
EEPERR	EEPROM error	Call Rice Lake Weighing Systems (RLWS) for service

Table 7-1. 420 Plus Error Messages

### 7.1.2 Using the XE EDP Command

The XE EDP command can be used to remotely query the 420 Plus for the error conditions shown on the front panel. The XE command returns two 5-digit numbers in the format:

xxxxx yyyyy

where xxxxx contains a decimal representation of any existing error conditions as described in Table 7-2.

If more than one error condition exists, the number returned is the sum of the values representing the error conditions. For example, if the XE command returns the number 1040, this value represents the sum of an A/D reference error (1024) and an A/D calibration checksum error (16).

The second number returned (yyyyy) uses the same bit assignments as shown in Table 7-2 to indicate whether the test for the error condition was run. For example, the value yyyyy = 50815 represents the decimal equivalent of the binary value 1100 0110 0111 1111. Using the bit assignments in Table 7-2, this value indicates all tests were run.

Error Code	Description	Binary Value
0x0001	EEPROM Error	0000 0000 0000 0001
0x0002	Virgin EEPROM	0000 0000 0000 0010
0x0004	Config Parameter Checksum	0000 0000 0000 0100
0x0008	Load Cell Checksum	0000 0000 0000 1000
0x0010	A/D Calibration Checksum	0000 0000 0001 0000
0x0020	Print Formats Checksum	0000 0000 0010 0000
0x0040	XA Internal RAM Error	0000 0000 0100 0000
0x0080	External RAM Error	0000 0000 1000 0000
0x0100	Reserved	0000 0001 0000 0000
0x0200	ADC Physical Error	0000 0010 0000 0000
0x0400	ADC Reference	0000 0100 0000 0000
0x0800	Count Error	0000 1000 0000 0000
0x1000	Reserved	0001 0000 0000 0000
0x2000	Display Range	0010 0000 0000 0000
0x4000	ADC Range	0100 0000 0000 0000
0x8000	Gross Limit	1000 0000 0000 0000
0x10000 - 0x80000000		Reserved

Table 7-2. Error Codes Returned on XE Command

## 7.2 Status Messages

Two EDP commands, P and ZZ, can be used to provide status about the indicator. These commands are described in the following sections.

### 7.2.1 Using the P EDP Command

The P EDP command returns the current displayed weight value to the EDP port, along with the units identifier. If the indicator is in an underrange or overload condition, the weight value is replaced with &&&&&& (overload) or ::::: (underrange).

### 7.2.2 Using the ZZ EDP Command

The ZZ EDP command can be used to remotely query which annunciators are currently displayed on the indicator front panel. The ZZ command returns the currently displayed weight and a decimal number representing the LED annunciators currently lit. The format of the returned data is:

wwwwwww uu zzz

where wwwwww uu is the current displayed weight and units, zzz is the annunciator status value (see Table 7-3). If more than one annunciator is lit, the second number returned is the sum of the values representing the active annunciators.

**Example:** If the annunciator status value returned on the ZZ command is 145, the gross, standstill, and lb annunciators are lit. 145 represents the sum of the values for the standstill annunciator (128), gross mode annunciator (16), and the lb/primary units annunciator (1).

Decimal Value	Annunciator
1	lb/primary units
2	kg/secondary units
4	Count
8	Tare entered
16	Gross
32	Net
64	Center of zero
128	Standstill

Table 7-3. Status Codes Returned on the ZZ Command

### 7.3 Continuous Output (Stream) Format

Figure 7-1 shows the continuous output format sent to the 420 Plus EDP or printer port when the STREAM parameter (SERIAL menu) is set to either EDP or PRN.

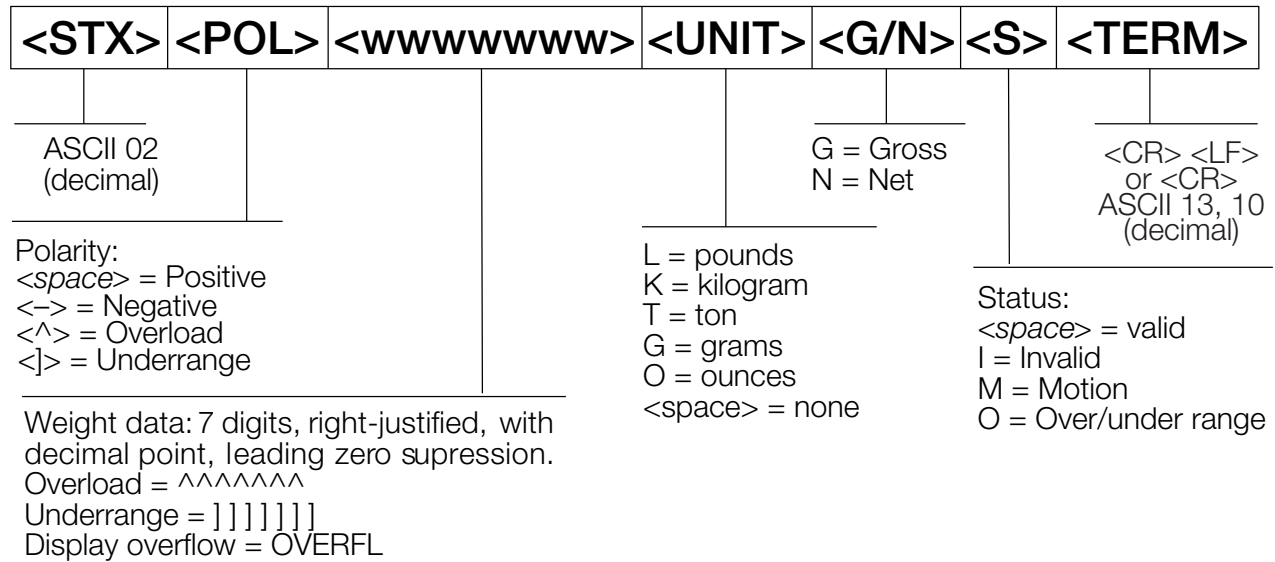

Figure 7-1. Continuous Output Data Format

## 7.4 ASCII Character Chart

Use the decimal values for ASCII characters listed in Tables 7-4 and 7-5 when specifying print format strings on the *420 Plus* PFORMAT menu. The actual character printed depends on the character mapping used by the output device.

The *420 Plus* can send or receive any ASCII character value (decimal 0–255), but the indicator display is limited to numbers, upper-case, unaccented letters, and a few special characters. See Section 7.5 on page 49 for information about the *420 Plus* LED display.

Control	ASCII	Dec	Hex	ASCII	Dec	Hex	ASCII	Dec	Hex	ASCII	Dec	Hex
Ctrl-@	NUL	00	00	space	32	20	@	64	40	`	96	60
Ctrl-A	SOH	01	01	!	33	21	A	65	41	a	97	61
Ctrl-B	STX	02	02	"	34	22	B	66	42	b	98	62
Ctrl-C	ETX	03	03	#	35	23	C	67	43	c	99	63
Ctrl-D	EOT	04	04	\$	36	24	D	68	44	d	100	64
Ctrl-E	ENQ	05	05	%	37	25	E	69	45	e	101	65
Ctrl-F	ACK	06	06	&	38	26	F	70	46	f	102	66
Ctrl-G	BEL	07	07	'	39	27	G	71	47	g	103	67
Ctrl-H	BS	08	08	(	40	28	H	72	48	h	104	68
Ctrl-I	HT	09	09	)	41	29	I	73	49	i	105	69
Ctrl-J	LF	10	0A	*	42	2A	J	74	4A	j	106	6A
Ctrl-K	VT	11	0B	+	43	2B	K	75	4B	k	107	6B
Ctrl-L	FF	12	0C	,	44	2C	L	76	4C	l	108	6C
Ctrl-M	CR	13	0D	-	45	2D	M	77	4D	m	109	6D
Ctrl-N	SO	14	0E	.	46	2E	N	78	4E	n	110	6E
Ctrl-O	SI	15	0F	/	47	2F	O	79	4F	o	111	6F
Ctrl-P	DLE	16	10	0	48	30	P	80	50	p	112	70
Ctrl-Q	DC1	17	11	1	49	31	Q	81	51	q	113	71
Ctrl-R	DC2	18	12	2	50	32	R	82	52	r	114	72
Ctrl-S	DC3	19	13	3	51	33	S	83	53	s	115	73
Ctrl-T	DC4	20	14	4	52	34	T	84	54	t	116	74
Ctrl-U	NAK	21	15	5	53	35	U	85	55	u	117	75
Ctrl-V	SYN	22	16	6	54	36	V	86	56	v	118	76
Ctrl-W	ETB	23	17	7	55	37	W	87	57	w	119	77
Ctrl-X	CAN	24	18	8	56	38	X	88	58	x	120	78
Ctrl-Y	EM	25	19	9	57	39	Y	89	59	y	121	79
Ctrl-Z	SUB	26	1A	:	58	3A	Z	90	5A	z	122	7A
Ctrl-[	ESC	27	1B	;	59	3B	[	91	5B	{	123	7B
Ctrl-\	FS	28	1C	<	60	3C	\	92	5C		124	7C
Ctrl-]	GS	29	1D	=	61	3D	]	93	5D	}	125	7D
Ctrl-^	RS	30	1E	>	62	3E	^	94	5E	~	126	7E
Ctrl- <sub>~</sub>	US	31	1F	?	63	3F	_	95	5F	DEL	127	7F

Table 7-4. ASCII Character Chart (Part 1)

ASCII	Dec	Hex	ASCII	Dec	Hex	ASCII	Dec	Hex	ASCII	Dec	Hex
Ç	128	80	á	160	A0		192	C0	α	224	E0
ü	129	81	í	161	A1		193	C1	β	225	E1
é	130	82	ó	162	A2		194	C2	Γ	226	E2
â	131	83	ú	163	A3		195	C3	π	227	E3
ä	132	84	ñ	164	A4		196	C4	Σ	228	E4
à	133	85	Ñ	165	A5		197	C5	σ	229	E5
å	134	86	ª	166	A6		198	C6	μ	230	E6
ç	135	87	º	167	A7		199	C7	τ	231	E7
ê	136	88	¿	168	A8		200	C8	Φ	232	E8
ë	137	89		169	A9		201	C9	Θ	233	E9
è	138	8A	¬	170	AA		202	CA	Ω	234	EA
ï	139	8B	½	171	AB		203	CB	δ	235	EB
î	140	8C	¼	172	AC		204	CC	∞	236	EC
ì	141	8D	¡	173	AD		205	CD	φ	237	ED
Ä	142	8E	«	174	AE		206	CE	€	238	EE
Å	143	8F	»	175	AF		207	CF	∩	239	EF
É	144	90		176	B0		208	D0	≡	240	F0
æ	145	91		177	B1		209	D1	±	241	F1
Æ	146	92		178	B2		210	D2	≥	242	F2
ô	147	93		179	B3		211	D3	≤	243	F3
ö	148	94		180	B4		212	D4	∫	244	F4
ò	149	95		181	B5		213	D5	∫	245	F5
û	150	96		182	B6		214	D6	÷	246	F6
ù	151	97		183	B7		215	D7	≈	247	F7
ÿ	152	98		184	B8		216	D8	°	248	F8
Ö	153	99		185	B9		217	D9	•	249	F9
Ü	154	9A		186	BA		218	DA		250	FA
¢	155	9B		187	BB		219	DB		251	FB
£	156	9C		188	BC		220	DC		252	FC
¥	157	9D		189	BD		221	DD	²	253	FD
Pts	158	9E		190	BE		222	DE		254	FE
f	159	9F		191	BF		223	DF		255	FF

Table 7-5. ASCII Character Chart (Part 2)

## 7.5 Front Panel Display Characters

Figure 7-2 shows the 7-segment LED character set used to display alphanumeric characters on the 420 Plus front panel.

	-	9	E	Q
	.	:	F	R
	/	;	G	S
	0	<	H	T
%	1	=	I	U
&	2	>	J	V
'	3	?	K	W
(	4	@	L	X
)	5	A	M	Y
*	6	B	N	Z
+	7	C	O	[
,	8	D	P	\

Figure 7-2. 420 Plus Display Characters

## 7.6 Conversion Factors for Secondary Units

The 420 Plus has the capability to mathematically convert a weight into many different types of units and instantly display those results with a press of the UNITS key.

Secondary units can be specified on the FORMAT menu using the SECNDR parameter, or by using EDP commands.



**Note** Multipliers are preconfigured within the indicator. Manual entry is only necessary when NONE is selected under UNITS. Long tons and grain units listed in Table 7-6 cannot be directly specified as primary or secondary units. For these or other unlisted units of weight, specify NONE under UNITS.

Ensure that the secondary decimal point position is set appropriately for the scale capacity in the secondary units. If the converted value requires more digits than are available, the indicator will display an overflow message (OVERFL).

For example, if the primary units are short tons, secondary units are pounds, and the secondary decimal point is set to 8888.88, the indicator will overflow if 5 tons or more are applied to the scale. With 5 tons applied, and a conversion factor of 2000, the secondary units display needs five digits to the left of the decimal point to display the 10000 lb secondary units value.

Primary Unit	x Multiplier	Secondary Unit
grains	0.064799	grams
	0.002286	ounces
	0.000143	pounds
	0.000065	kilograms
ounces	437.500	grains
	28.3495	grams
	0.06250	pounds
	0.02835	kilograms
pounds	7000.00	grains
	453.592	grams
	16.0000	ounces
	0.453592	kilograms
	0.000500	short tons
	0.000446	long tons
	0.000453	metric tons
short tons	2000.00	pounds
	907.185	kilograms
	0.892857	long tons
	0.907185	metric tons
grams	15.4324	grains
	0.035274	ounces
	0.002205	pounds
	0.001000	kilograms
kilograms	15432.4	grains
	35.2740	ounces
	1000.00	grams
	2.20462	pounds
	0.001102	short tons
	0.000984	long tons
	0.001000	metric tons
metric tons	2204.62	pounds
	1000.00	kilograms
	1.10231	short tons
	0.984207	long tons
long tons	2240.00	pounds
	1016.05	kilograms
	1.12000	short tons
	1.01605	metric tons



**Note** Multipliers in italics are preconfigured

Table 7-6. Conversion Factors

## 7.7 Digital Filtering

The 420 Plus uses averaged digital filtering to reduce the effect of vibration on weight readings. Adjustable threshold and sensitivity functions allow quick settling by suspending filter averaging, allowing the weight reading to jump to the new value. Figure 7-3 shows the digital filter parameters on the CONFIG menu.

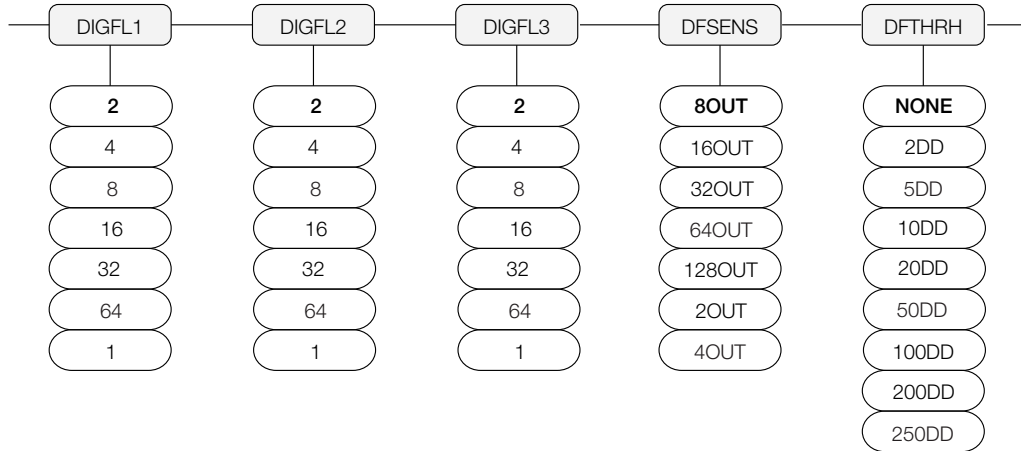

Figure 7-3. Digital Filtering Parameters on the Configuration (CONFIG) Menu

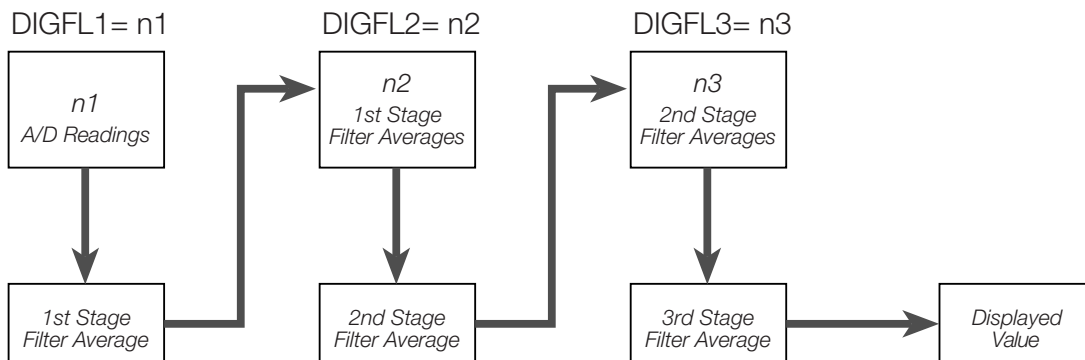

Figure 7-4. Flow Diagram for 420 Plus Digital Filters

### 7.7.1 DIGFLx Parameters

The first three digital filtering parameters, DIGFL1, DIGFL2, and DIGFL3, are configurable filter stages that control the effect of a single A/D reading on the displayed weight. The value assigned to each parameter sets the number of readings received from the preceding filter stage before averaging (see Figure 7-4).

The overall filtering effect can be expressed by adding the values assigned to the three filter stages:

$$\text{DIGFL1} + \text{DIGFL2} + \text{DIGFL3}$$

For example, if the filters are configured as DIGFL1=4, DIGFL2=8, DIGFL3=8, the overall filtering effect is 20 (4 + 8 + 8). With this configuration, each A/D reading has a 1-in-20 effect on the displayed weight value. Setting the filters to 1 effectively disables digital filtering.

### 7.7.2 DFSENS and DFTHRH Parameters

The three digital filters can be used by themselves to eliminate vibration effects, but heavy filtering also increases settling time. The DFSENS (digital filter sensitivity) and DFTHRH (digital filter threshold) parameters can be used to temporarily override filter averaging and improve settling time:

- DFSENS specifies the number of consecutive scale readings that must fall outside the filter threshold (DFTHRH) before digital filtering is suspended.
- DFTHRH sets a threshold value, in display divisions. When a specified number of consecutive scale readings (DFSENS) fall outside of this threshold, digital filtering is suspended. Set DFTHRH to NONE to turn off the filter override.

### 7.7.3 Setting the Digital Filter Parameters

Fine-tuning the digital filter parameters greatly improves indicator performance in heavy-vibration environments. Use the following procedure to determine vibration effects on the scale and optimize the digital filtering configuration.

1. In setup mode, set all three digital filters (DIGFL1, DIGFL2, DIGFL3) to 1. Set DFTHRH to NONE. Return indicator to normal mode.
2. Remove all weight from the scale, then watch the indicator display to determine the magnitude of vibration effects on the scale. Record the weight below which all but a few readings fall. This value is used to calculate the DFTHRH parameter value in Step 4.

For example, if a heavy-capacity scale produces vibration-related readings of up to 50 lb, with occasional spikes to 75 lb, record 50 lb as the threshold weight value.

3. Place the indicator in setup mode and set the digital filters (DIGFLx) to eliminate the vibration effects on the scale. (Leave DFTHRH set to NONE.) Reconfigure as necessary to find the lowest effective values for the DIGFLx parameters.
4. With optimum values assigned to the DIGFLx parameters, calculate the DFTHRH parameter value by converting the weight value recorded in Step 2 to display divisions:

$$\text{threshold\_weight\_value} / \text{DSPDIV}$$

In the example in Step 2, with a threshold weight value of 50 lb and a display division value of 5lb:  $50 / 5\text{lb} = 10\text{DD}$ . DFTHRH should be set to 10DD for this example.

5. Finally, set the DFSENS parameter high enough to ignore transient peaks. Longer transients (typically caused by lower vibration frequencies) will cause more consecutive out-of-band readings, so DFSENS should be set higher to counter low frequency transients.

Reconfigure as necessary to find the lowest effective value for the DFSENS parameter.

## 7.8 Analog Output Calibration

The following calibration procedure requires a multimeter to measure voltage or current output from the analog output module. If the option is not already installed, see Section 2.3.7 on page 13.



**Note** The analog output must be calibrated **after** the indicator itself has been configured (Section 3.0) and calibrated (Section 4.0).

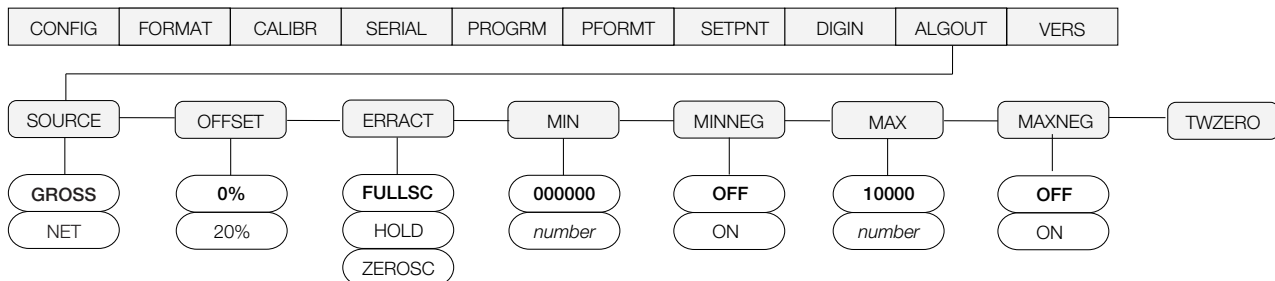

Figure 7-5. Analog Output Menu

1. Enter setup mode and go to the ALGOUT menu (see Figure 7-5).
  - Set OFFSET to 0% for 0–10 V output, 20% for 4–20 mA output
  - Set MIN to lowest weight value to be tracked by the analog output
  - Set MAX to highest weight value to be tracked by the analog output
2. Connect multimeter to analog output:
  - For voltage output, connect voltmeter leads to pins three and four
  - For current output, connect ammeter leads to pins one and two
3. Adjust zero calibration: Scroll to the TWZERO parameter. Check voltage or current reading on multimeter. Press and hold  $\Delta$  or  $\nabla$  to adjust the zero value up or down.
4. Adjust span calibration: Scroll to the TWSPAN parameter. Check voltage or current reading on multimeter. Press and hold  $\Delta$  or  $\nabla$  to adjust the span value up or down.
5. Final zero calibration: Return to the TWZERO parameter and verify that the zero calibration has not drifted. Press and hold  $\Delta$  or  $\nabla$  to re-adjust the zero value as required.
6. Return to normal mode. Analog output function can be verified using test weights.

## 7.9 Test Mode

In addition to normal and setup modes, test mode provides a number of diagnostic functions for the 420 Plus, including:

- Display raw A/D count
- Reset configuration parameters to default values
- A/D internal calibration



**Note** Test Mode is intended for factory use only.

To enter test mode, press and hold the setup switch until the front panel display shows the word *TEST*. After about three seconds, the test mode display automatically shifts to the first test menu function, A/DTST.

Figure 7-6 shows the Test Menu structure; Figure 7-7 shows the front panel key functions in test mode. Note that, because the Test Menu functions are all on a single menu level, the GROSS/NET (▽) key has no function. Press the ZERO (△) key to exit test mode.

Table 7-7 summarizes the test menu functions.



Figure 7-6. Test Mode Menu

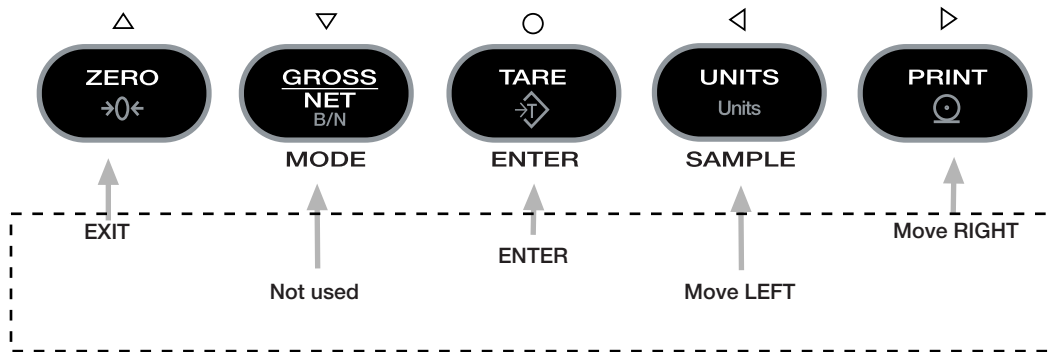

Figure 7-7. Front Panel Key Functions in Test Mode

TEST Menu	
Function	Description
A/DTST	Display A/D test Press and hold Enter key to display raw count from A/D converter.
DEFLT	Default parameters Press setup switch and Enter key at the same time to reset configuration and calibration parameters to factory default values. Load cells must be recalibrated before using the indicator (see Section 4.0 on page 32).

Table 7-7. Test Mode Menu Functions

## 7.10 Regulatory Mode Functions

REGULAT Parameter Value	Weight on Scale	Tare in System	Front Panel Key Function	
			TARE	ZERO
NTEP	zero or negative	no	no action	ZERO
		yes	CLEAR TARE	
	positive	no	TARE	
		yes	TARE	
CANADA	zero or negative	no	no action	TARE
		yes	CLEAR TARE	
	positive	no	TARE	
		yes	no action	
OIML	zero or negative	no	no action	ZERO
		yes	CLEAR TARE	ZERO and CLEAR TARE
	positive	no	TARE	ZERO
		yes	TARE	ZERO and CLEAR TARE
NONE	zero or negative	no	TARE	ZERO
		yes	CLEAR TARE	
	positive	no	TARE	
		yes	CLEAR TARE	

Table 7-8. TARE and ZERO Key Functions for REGULAT Parameter Settings

## 7.11 LED Functions

The following is a list of diagnostic LEDs for the 420 Plus. see Figure 2-4 10 for locations on the 420 Plus CPU board.

### Serial Port Status

LED1 (EDP Port)	Flashing red = TXD activity Flashing green = RXD activity On steady or off = No activity
LED2 (PRN Port)	Flashing red = TXD activity Flashing green = RXD activity On steady or off = No activity

### Power Supply

LED (+5AV)	Excitation/ADC supply on
LED (+5V & +3.3V)	Digital logic supply on

### Operation Status

LEDHB (Microprocessor)	Flashing green = Active Red = Fault
LED AD (ADC)	Green = Active Red = Fault
LED MEM (Memory Test)	Green = Pass Red = Fail
LED ANA (Analog Option Card)	Red = Not Implemented

### Digital Input/Output Status

DO 1 (Digital Out 1)	On when lit (active low)
DO2 (Digital Out 2)	On when lit (active low)
DI 1 (Digital In 1)	On when lit (active low)
DI 2 (Digital In 2)	On when lit (active low)

## 7.12 Specifications

### Model Numbers

United States	420-2A (AC) (NEMA Type 5-15) 420-2C (DC)
International	420-2B (AC) (CEE-7) 420-2D (DC)

### Power - AC

Line Voltages	115 or 230 VAC
Frequency	50 or 60 Hz
Power Consumption	1.5 A @ 115 VAC (8W) 0.75 A @ 230 VAC (8W)
Fusing	2.5 A 5 x 20 mm fuse

### Power - DC

Line Voltages	9-36 VDC DC Input
Power Consumption	1.5 A Max
Fusing	Internal short circuit protection

### Analog Specifications

Full Scale Input Signal	Up to 22.5 mV
Excitation Voltage	+5V single sided 8 x 350Ω or 16 x 700Ω load cells
Sense Amplifier	Differential amplifier with 4- and 6-wire sensing
Analog Signal Input Range	-0.5 mV/V to +4.5 mV/V
Analog Signal Sensitivity	0.3 μV/graduation minimum, 1.5 μV/grad recommended
Input Impedance	200 MΩ, typical
Noise (ref to input)	0.3 μV p-p with digital filters at 4-4-4
Internal Resolution	8,000,000 counts
Display Resolution	100 000 dd
Measurement Rate	Up to 60 measurements/sec
Input Sensitivity	10 nV per internal count
System Linearity	Within 0.01% of full scale
Zero Stability	150 nV/°C, maximum
Span Stability	3.5 ppm/°C, maximum
Calibration Method	Software, constants stored in EEPROM
Common Mode Voltage	-2.35 to +3.45 V, referred to ground
Rejection	130 dB minimum @ 50 or 60 Hz
Normal Mode Rejection	90 dB minimum @ 50 or 60 Hz
Input Overload	± 12 V continuous, static discharge protected
RFI Protection	Signal, excitation, and sense lines protected by capacitor bypass
Analog Output	Optional: fully isolated, voltage or current output, 14-bit resolution. Voltage output: 0 -10 VDC Load resistance: 1KΩ minimum Current output: 4-20 mA External loop resistance: 500Ω maximum

### Digital Specifications

Microcomputer	Phillips PXAG30K main processor @ 19.6608 MHz
Digital Inputs	2 inputs, TTL or switch closure, active-low
Digital Outputs	2 outputs, 250 mA Max Sink
Digital Filters	3 filters, software selectable

### Serial Communications

EDP Port	Full duplex RS-232
Printer Port	fully capable RS-232 or active 20 mA current loop (transmit only)
Both Ports	38400, 19200, 9600, 4800, 2400, 1200, 600, 300 bps; 7 or 8 data bits; even, odd, or no parity

### Operator Interface

Display	6-digit LED display. 7-segment, 0.8 in (20 mm) digits
LED annunciators	Gross, net, center of zero, standstill, lb/ primary units, kg/secondary units, count, tare
Keypad	21-key flat membrane panel

### Environmental

Operating Temperature	-10 to +40°C (legal); -10 to +50°C (industrial)
Storage Temperature	-25 to +70°C
Humidity	0-95% relative humidity

### Enclosure

Enclosure Dimensions	9.5 in x 6 in x 3.12 in 24 cm x 15 cm x 8 cm
Weight	2.8 Kg (6.1 lb)
Rating/Material	UL Type 4X

### Certifications and Approvals



NTEP	
CoC Number	04-076
Accuracy Class	III/III L $n_{max}$ : 10 000
Measurement Canada (Pending)	
Accuracy Class	III/III HD $n_{max}$ : 10 000



The 420 Plus complies with Part 15 of the FCC Rules. Operation is subject to the following conditions:

- This device may not cause harmful interference.
- This device must accept any interference received, including interference that may cause undesired operation.



## 420 Plus Limited Warranty

---

Rice Lake Weighing Systems (RLWS) warrants that all RLWS equipment and systems properly installed by a Distributor or Original Equipment Manufacturer (OEM) will operate per written specifications as confirmed by the Distributor/OEM and accepted by RLWS. All systems and components are warranted against defects in materials and workmanship for two years.

RLWS warrants that the equipment sold hereunder will conform to the current written specifications authorized by RLWS. RLWS warrants the equipment against faulty workmanship and defective materials. If any equipment fails to conform to these warranties, RLWS will, at its option, repair or replace such goods returned within the warranty period subject to the following conditions:

- Upon discovery by Buyer of such nonconformity, RLWS will be given prompt written notice with a detailed explanation of the alleged deficiencies.
- Individual electronic components returned to RLWS for warranty purposes must be packaged to prevent electrostatic discharge (ESD) damage in shipment. Packaging requirements are listed in a publication, *Protecting Your Components From Static Damage in Shipment*, available from RLWS Equipment Return Department.
- Examination of such equipment by RLWS confirms that the nonconformity actually exists, and was not caused by accident, misuse, neglect, alteration, improper installation, improper repair or improper testing; RLWS shall be the sole judge of all alleged non-conformities.
- Such equipment has not been modified, altered, or changed by any person other than RLWS or its duly authorized repair agents.
- RLWS will have a reasonable time to repair or replace the defective equipment. Buyer is responsible for shipping charges both ways.
- In no event will RLWS be responsible for travel time or on-location repairs, including assembly or disassembly of equipment, nor will RLWS be liable for the cost of any repairs made by others.

**THESE WARRANTIES EXCLUDE ALL OTHER WARRANTIES, EXPRESSED OR IMPLIED, INCLUDING WITHOUT LIMITATION WARRANTIES OF MERCHANTABILITY OR FITNESS FOR A PARTICULAR PURPOSE. NEITHER RLWS NOR DISTRIBUTOR WILL, IN ANY EVENT, BE LIABLE FOR INCIDENTAL OR CONSEQUENTIAL DAMAGES.**

**RLWS AND BUYER AGREE THAT RLWS' SOLE AND EXCLUSIVE LIABILITY HEREUNDER IS LIMITED TO REPAIR OR REPLACEMENT OF SUCH GOODS. IN ACCEPTING THIS WARRANTY, THE BUYER WAIVES ANY AND ALL OTHER CLAIMS TO WARRANTY.**

**SHOULD THE SELLER BE OTHER THAN RLWS, THE BUYER AGREES TO LOOK ONLY TO THE SELLER FOR WARRANTY CLAIMS.**

**NO TERMS, CONDITIONS, UNDERSTANDING, OR AGREEMENTS PURPORTING TO MODIFY THE TERMS OF THIS WARRANTY SHALL HAVE ANY LEGAL EFFECT UNLESS MADE IN WRITING AND SIGNED BY A CORPORATE OFFICER OF RLWS AND THE BUYER.**

© 2019 Rice Lake Weighing Systems, Inc. Rice Lake, WI USA. All Rights Reserved.

RICE LAKE WEIGHING SYSTEMS • 230 WEST COLEMAN STREET • RICE LAKE, WISCONSIN 54868 • USA





© Rice Lake Weighing Systems    Content subject to change without notice.

230 W. Coleman St. • Rice Lake, WI 54868 • USA    USA: 800-472-6703 • International: +1-715-234-9171

---

**[www.ricelake.com](http://www.ricelake.com)**