

1280 Belt HMI Program

For use with SCT-4XD Digitizer

Software Manual



© Rice Lake Weighing Systems. All rights reserved.

Rice Lake Weighing Systems® is a registered trademark of
Rice Lake Weighing Systems.

All other brand or product names within this publication are trademarks or
registered trademarks of their respective companies.

All information contained within this publication is, to the best of our knowledge, complete and
accurate at the time of publication. Rice Lake Weighing Systems reserves the right to make
changes to the technology, features, specifications and design of the equipment without notice.

The most current version of this publication, software, firmware and all other product
updates can be found on our website:

www.ricelake.com

Revision History

This section tracks and describes manual revisions for awareness of major updates.

Revision	Date	Description
A	February 21, 2025	Initial manual release with product launch; Firmware version 1.08
B	March 10, 2025	Established revision history

Table i. Revision Letter History



Technical training seminars are available through Rice Lake Weighing Systems. Course descriptions and dates can be viewed at www.ricelake.com/training or obtained by calling 715-234-9171 and asking for the training department.

Contents

1.0 Introduction	5
1.1 Safety	5
1.2 Disposal	6
1.3 1280 HMI Belt Scale Digitizer Display	6
2.0 Setup	7
2.1 Password Setup	8
2.2 Initial Settings	8
2.3 General Parameters	9
2.4 Analog Output Parameters	9
2.5 Belt Parameters	10
2.6 Calibration Parameters	10
2.7 Test Weight Calibration	11
2.8 Alarm Settings	11
2.9 Diagnostic Menu	12
3.0 Calibration	13
3.1 Test Weight Calibration	13
3.2 BulkSlide Calibration	18
3.3 Analog Output	19
3.4 Communications	20
4.0 Fieldbus	21
4.1 1280 HMI Configuration	21
4.2 Database	21
4.3 Input Register	22



Rice Lake continually offers web-based video training on a growing selection of product-related topics at no cost. Visit www.ricelake.com/webinars

1.0 Introduction

This document describes how to use the 1280 Human Machine Interface (HMI) program with an SCT-4XD Belt Scale Digitizer. Refer to the SCT-4XD Technical Manual (PN 227386) for details about the various configuration settings.



Manuals are available from Rice Lake Weighing Systems at www.ricelake.com/manuals

Warranty information is available at www.ricelake.com/warranties

1.1 Safety

Safety Definitions:



DANGER: Indicates an imminently hazardous situation that, if not avoided, will result in death or serious injury. Includes hazards that are exposed when guards are removed.



WARNING: Indicates a potentially hazardous situation that, if not avoided, could result in serious injury or death. Includes hazards that are exposed when guards are removed.



CAUTION: Indicates a potentially hazardous situation that, if not avoided, could result in minor or moderate injury.



IMPORTANT: Indicates information about procedures that, if not observed, could result in damage to equipment or corruption to and loss of data.

General Safety

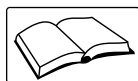

Do not operate or work on this equipment unless this manual has been read and all instructions are understood. Failure to follow the instructions or heed the warnings could result in injury or death. Contact any Rice Lake Weighing Systems dealer for replacement manuals.



WARNING

Failure to heed could result in serious injury or death.

Some procedures described in this manual require work inside the enclosure. These procedures are to be performed by qualified service personnel only.

Take all necessary safety precautions when installing the weigh frame, including wearing safety shoes, protective eye wear, and using the proper tools.

Keep hands, feet and loose clothing away from moving parts.

Do not approach a running conveyor from underneath.

Do not bend over a running conveyor.

Do not allow minors (children) or inexperienced persons to operate this unit.

Do not operate without all shields and guards in place.

Do not jump on the scale.

Do not use for purposes other than weight taking.

Do not place fingers into slots or possible pinch points.

Do not use any load bearing component that is worn beyond 5% of the original dimension.

Do not use this product if any of the components are cracked.

Do not exceed the rated load limit of the unit.

Do not make alterations or modifications to the unit.

Do not remove or obscure warning labels.

Do not use near water.

1.2 Disposal



Product Disposal

The product must be brought to appropriate separate waste collection centers at the end of its life cycle.

Proper separate collection to recycle the product helps prevent possible negative effects on the environment and to health, and promotes the recycling of the materials. Users who dispose of the product illegally shall face administrative sanctions as provided by law.

1.3 1280 HMI Belt Scale Digitizer Display

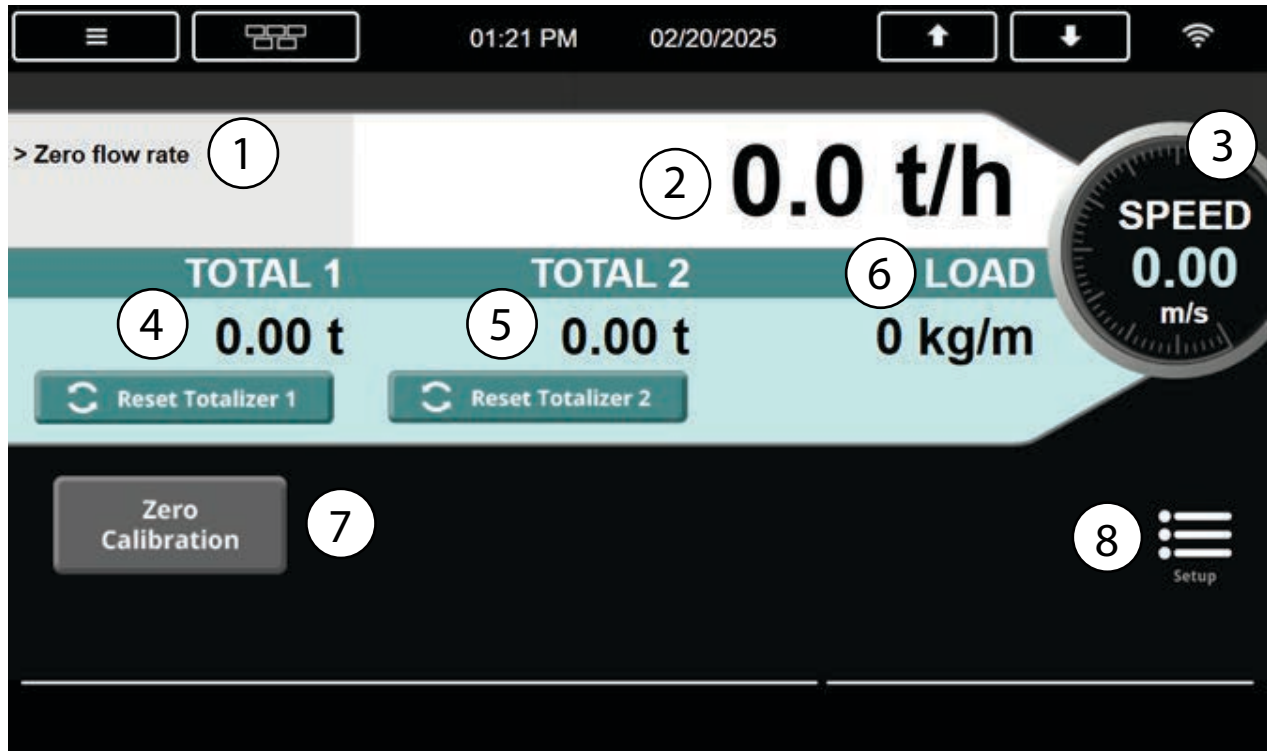

Figure 1-1. Main Display

Item	Description
1	System messages
2	Calculated flow rate
3	Belt speed
4	Totalizer 1
5	Totalizer 2
6	Weighframe load
7	Zero Calibration (Section 3.0 on page 13)
8	Setup menu (see Section 2.0 on page 7)

Table 1-1. Display Items



NOTE: Totalizer data is held in the SCT-4XD memory. Totalizers may be reset using the Reset Totalizer buttons. System will prompt for confirmation of the reset.

2.0 Setup

When entering the Setup menu, the 1280 HMI uploads the current SCT-4XD configuration.

 **IMPORTANT: No data is stored at the 1280 HMI level.**

The Setup menu is structured the same as the SCT-4XD on-board Setup menu except for:

- **Password Setup:** Passwords are only used or maintained at the 1280 HMI level.
- **Test Weight Calibration:** Part of the SCT-4XD User menu.
- **Communication Menu:** The 1280 HMI does not have access to the SCT-4XD Communication menu.
- **Default:** The 1280 HMI does not have access to the SCT-4XD Default menu.

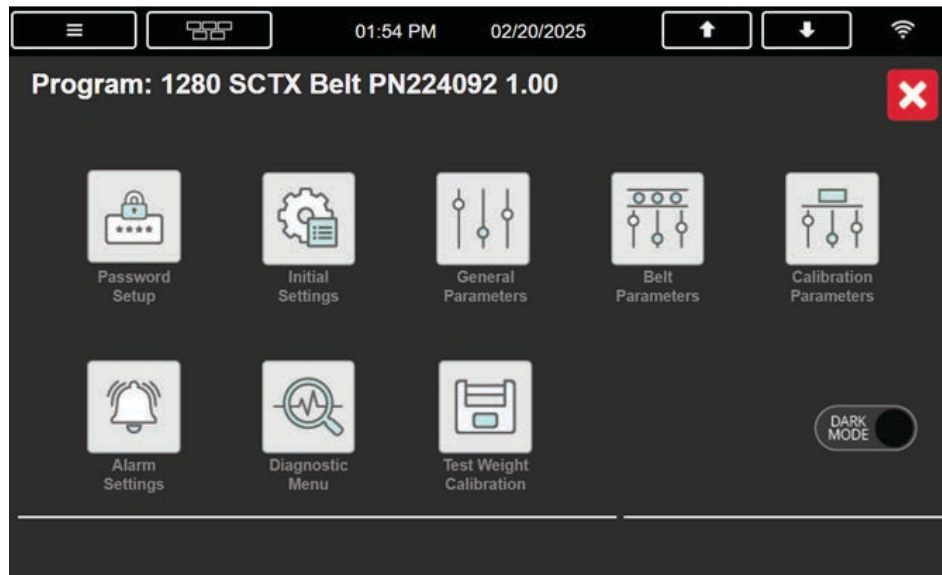

Figure 2-1. Setup Menu

2.1 Password Setup

The Password Setup menu allows password setup for restricted access to:

- Setup Menu
- Totalizer Resets
- Zero Calibration
- Test Weight Calibration

Program: 1280 SCTX Belt PN224092 1.00

Password Setup

Setup Password	Test Weight Cal. Password
Totalizer 1 Password	
Totalizer 2 Password	
Zero Calibration Password	

Figure 2-2. Password Setup Display

2.2 Initial Settings

The Initial Settings menu allows toggling between the following settings:

- Unit systems: Metric or US
- Operative mode: Belt or BulkSlide

Program: 1280 SCTX Belt PN224092 1.00

Initial Settings

Unit systems
Metric
Operative mode
Belt

Figure 2-3. Initial Settings Display



IMPORTANT: The SCT-4XD does not update its configuration settings until the 1280 HMI exits the Setup menu. If the Initial Settings are changed, exit the Setup menu so the settings are transmitted to the SCT-4XD before proceeding to other configuration settings.

2.3 General Parameters

Configure the General Parameters as shown:

Program: 1280 SCTX Belt PN224092 1.00 ✕

General Parameters

Pulse weight	Input 1 function	Output 2 function	Analog output
0.00 t	Encoder	None	...
Pulse time width	Input 2 function	Output 2 NO/NC	
0.0 sec	None	NO	
	Output 1 function		
	None		
	Output 1 NO/NC		
	NO		

Figure 2-4. General Parameters Display

2.4 Analog Output Parameters

Configure the Analog Output Parameters as shown:

Program: 1280 SCTX Belt PN224092 1.00 ✕

General Parameters / Analog Output

Function	Manual speed (DAC)
Flow	0
Mode	
4-20mA	
Min DAC value	
12506	
Max DAC value	
57970	

Figure 2-5. Analog Output Display

2.5 Belt Parameters

Configure the Belt Parameters as shown:

Program: 1280 SCTX Belt PN224092 1.00			
Belt Parameters			
Total resolution	Max Load	Pulse length 2	Show flow in DB
0.01 t	10 kg/m (lb/ft)	3.14 mm	No
Flow-rate resolution	Encoder 1	Max speed	Totalize negative
0.1 t/h	Yes	1.00 m/s	No
Max flow-rate	Pulse length 1	Speed difference	Filter parameters
200.0 t/h	3.14 mm	1 %	...
Load resolution	Encoder 2	Dead band	Store totals
1 kg/m	No	2.0 %	...

Figure 2-6. Belt Parameters Display

2.6 Calibration Parameters

Configure the Calibration Parameters as shown:

Program: 1280 SCTX Belt PN224092 1.00			
Calibration Parameters			
Number of channels	Weigh length	Belt angle	Zero range
1	1000 mm	0.0 °	10.0 %
Loadcell capacity	Pivot to LC distance	Correction factor	Auto zero range
200.000 kg	0 mm	1.000000	0.0 %
Loadcell sensitivity	Pivot to idler dist.	Belt length	Auto zero limit
2.00000 mV/V	0 mm	10.0 m	0.0 %
Loadcell zero mV/V	Serial inclinometer	Zero revolutions	Test weight calibration
0.00000 mV/V	No	1	...

Figure 2-7. Calibration Parameters Display

2.7 Test Weight Calibration

Configure the Test Weight Calibration values as shown:

Program: 1280 SCTX Belt PN224092 1.00	
Test Weight Calibration	
Test weight	0.00 kg
Delay (output)	0.0 sec
Test distance	0.00 m
Material factor	1.000000

Figure 2-8. Test Weight Calibration Display



IMPORTANT: The SCT-4XD does not update its configuration settings until the 1280 HMI exits the Setup menu. If the Test Weight Calibration settings are changed, exit the Setup menu so the settings are transmitted to the SCT-4XD before proceeding to other configuration settings.

2.8 Alarm Settings

Configure the Alarm Settings as shown:

Program: 1280 SCTX Belt PN224092 1.00			
Alarm Settings			
Off-track	Overload Flow Rate	Flow rate	Max flow rate
No	No	No	0.0 t/h
Alarm time	Alarm time	Alarm time	
0.0 sec	0.0 sec	0.0 sec	
Lock time	Lock time	Lock time	
0.0 sec	0.0 sec	0.0 sec	
	Overflow flow rate	Min flow rate	
	0.0 %	0.0 t/h	

Figure 2-9. Alarm Settings (page 1)

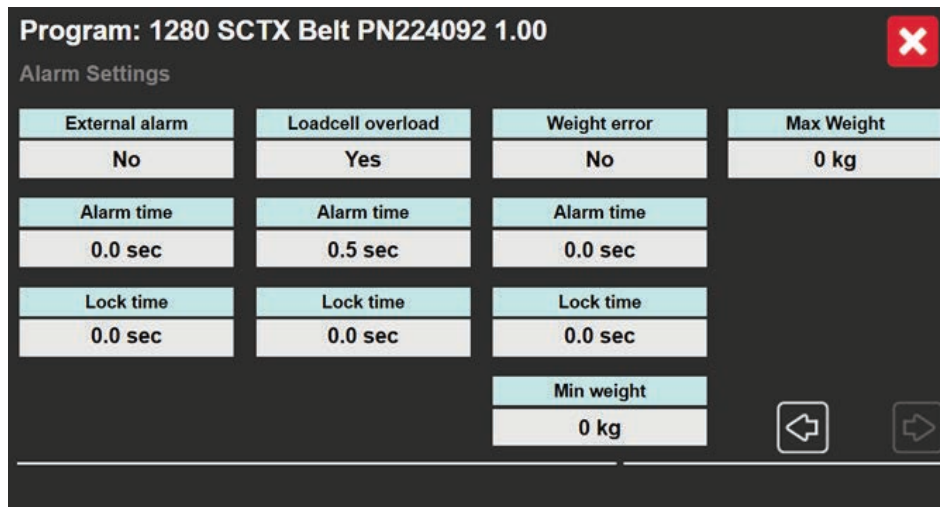

Figure 2-10. Alarm Settings (page 2)

2.9 Diagnostic Menu

Displays live mV levels for all configured load cell channels and live encoder speeds.



NOTE: To view diagnostic information on the main operating screen, set the Display in home scr. button to YES.

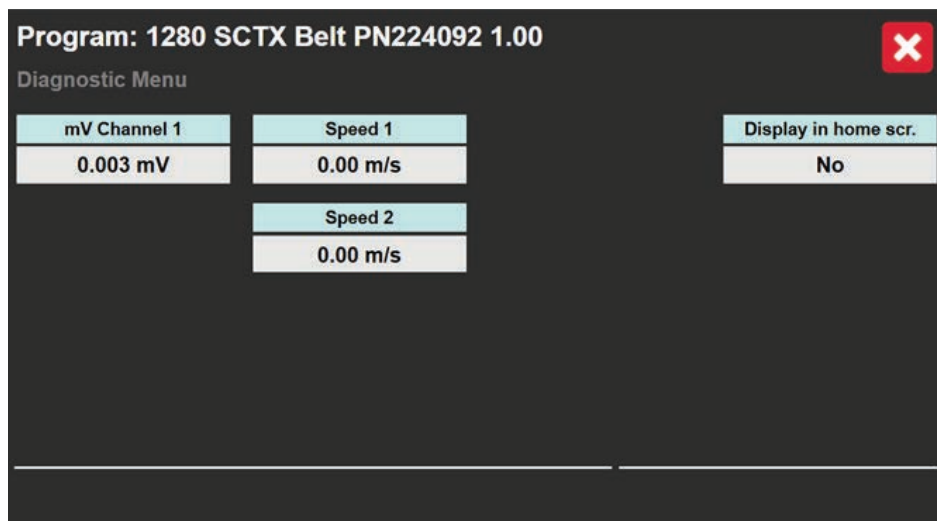

Figure 2-11. Diagnostic Menu

3.0 Calibration

3.1 Test Weight Calibration



IMPORTANT: At a minimum, the following settings must be properly configured to match your weigh frame and conveyor specifications before performing calibration.

Configure the following parameters:

- Initial Settings: Select Metric or US (see [Section 2.2 on page 8](#), Save and Exit before making other changes to configuration)
- General Parameters: Configure Encoder (if present, see [Section 2.3 on page 9](#))
- Belt Parameters:
 - Enable Encoder (if present)
 - Configure Encoder Pulse Length (if encoder is used)
 - Configure Fixed Belt Speed (if no encoder is used)
- Calibration Parameters (see [Section 2.6 on page 10](#)):
 - Configure the number of load cell channels to the correct number
 - Capture Static Zero by entering Zero mV value or capturing Zero mV value with the SCT-4XD Digitizer
 - Configure Weigh Length
 - Configure Load cell Capacity
 - Configure Load cell Sensitivity
 - Configure Belt Length if encoder is used
 - Configure Belt Zero Time if encoder is not used
 - Test Weight Calibration:
 - Configure Test Weight Value
 - Configure Test Distance (if encoder is used)
 - Configure Test Time (if encoder is not used)
- Save and Exit the Setup Menu before proceeding to calibration

Perform the following to calibrate:

1. From the Main Operating Screen, with the belt running at zero load, press the **Zero Calibration** button.

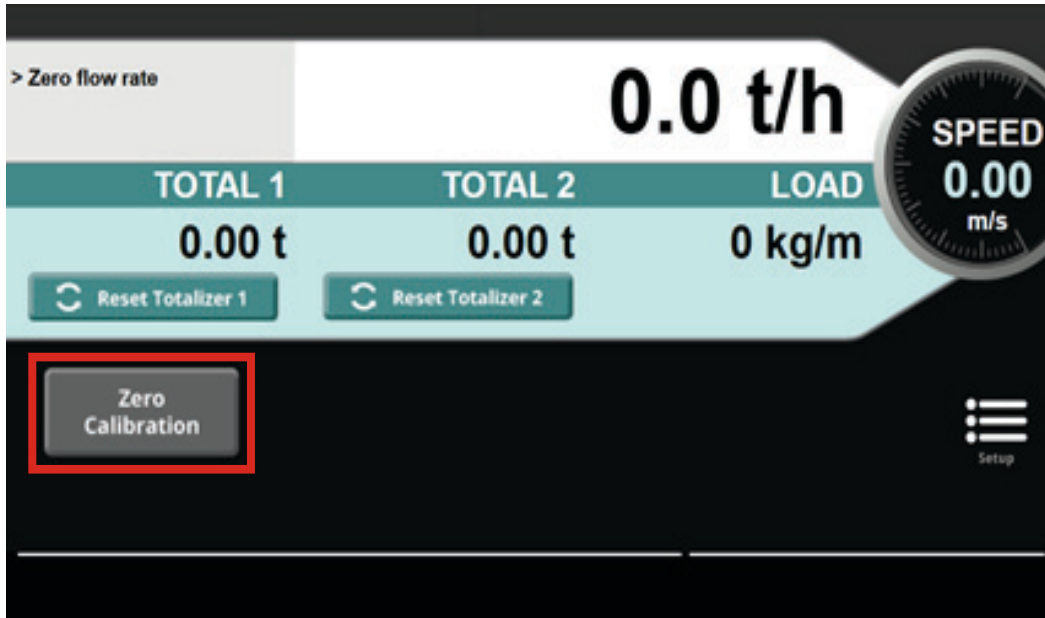

Figure 3-1. Zero Calibration Button

2. Select **YES** to perform a Zero Calibration.

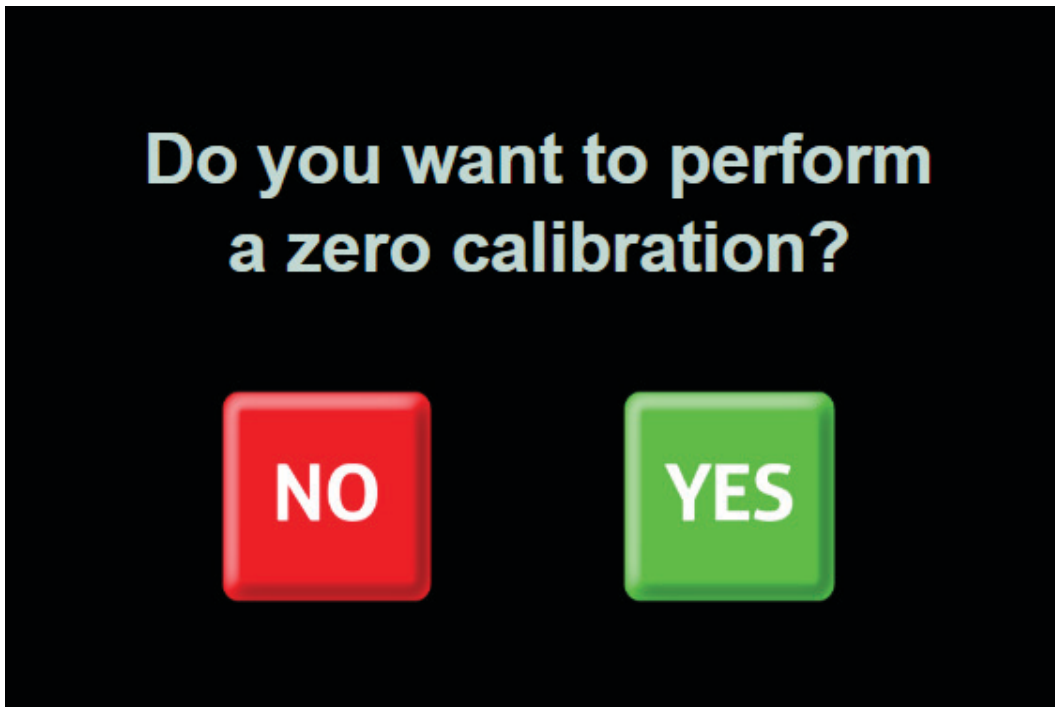

Figure 3-2. Zero Calibration Confirmation Prompt

- Wait for Zero Calibration to complete.

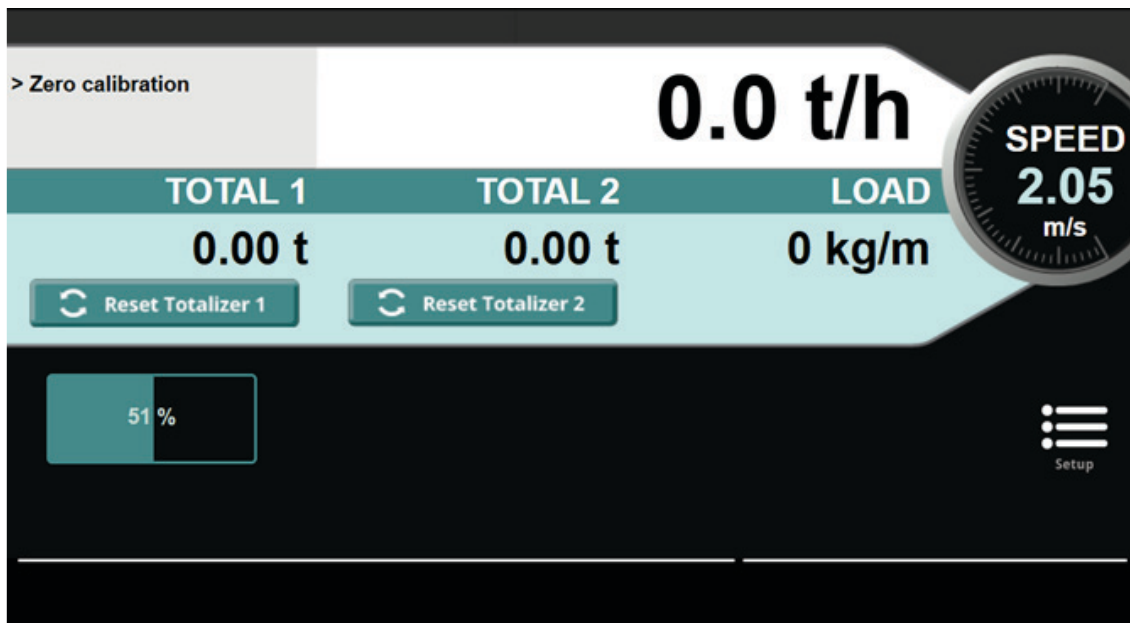

Figure 3-3. Zero Calibration Progress Bar

- Hang or put test weights on the belt scale weighframe.
- Enter Setup Menu and press **Test Weight Calibration** button.

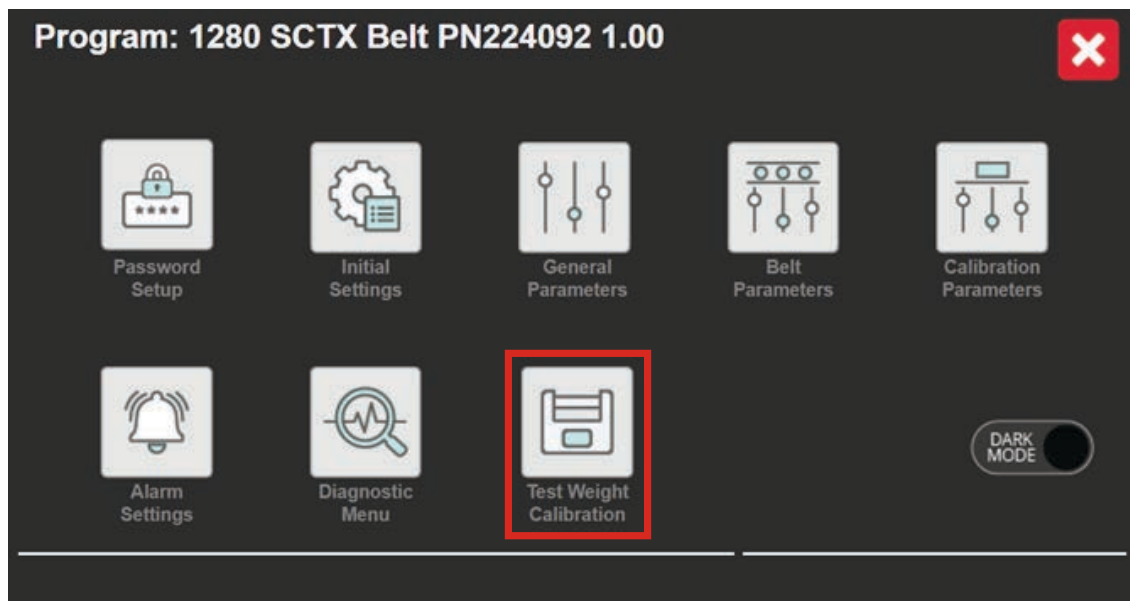

Figure 3-4. Test Weight Calibration Button

6. Select **YES** to start a test weight calibration.

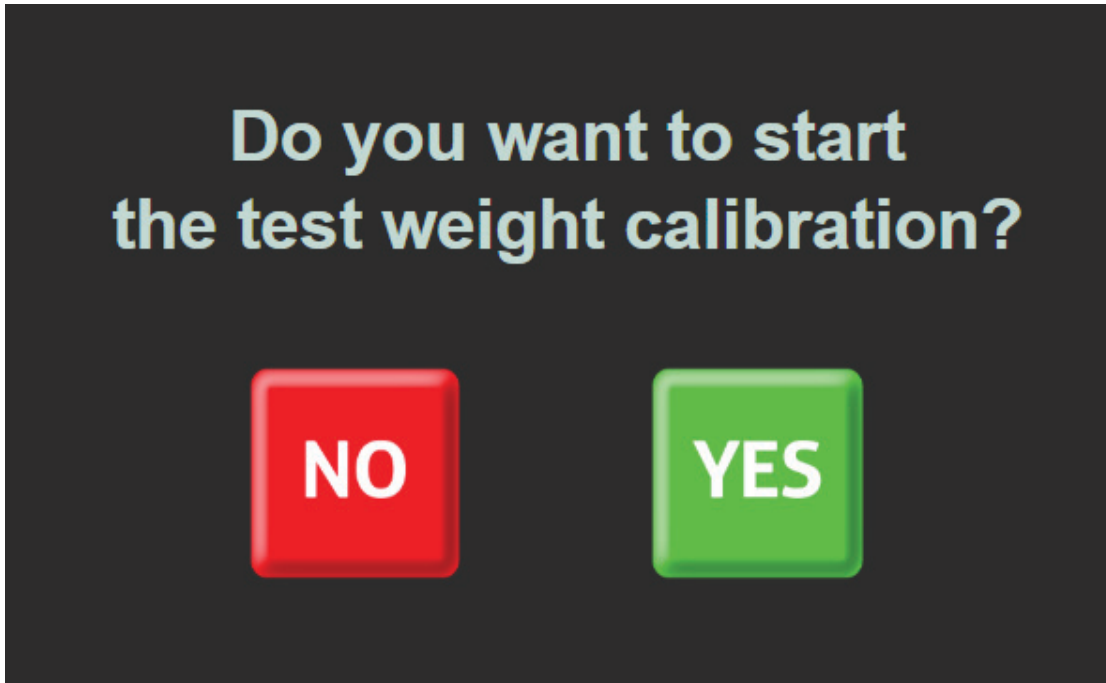

Figure 3-5. Test Weight Calibration Confirmation Prompt

7. Wait for Test Weight Calibration to complete.

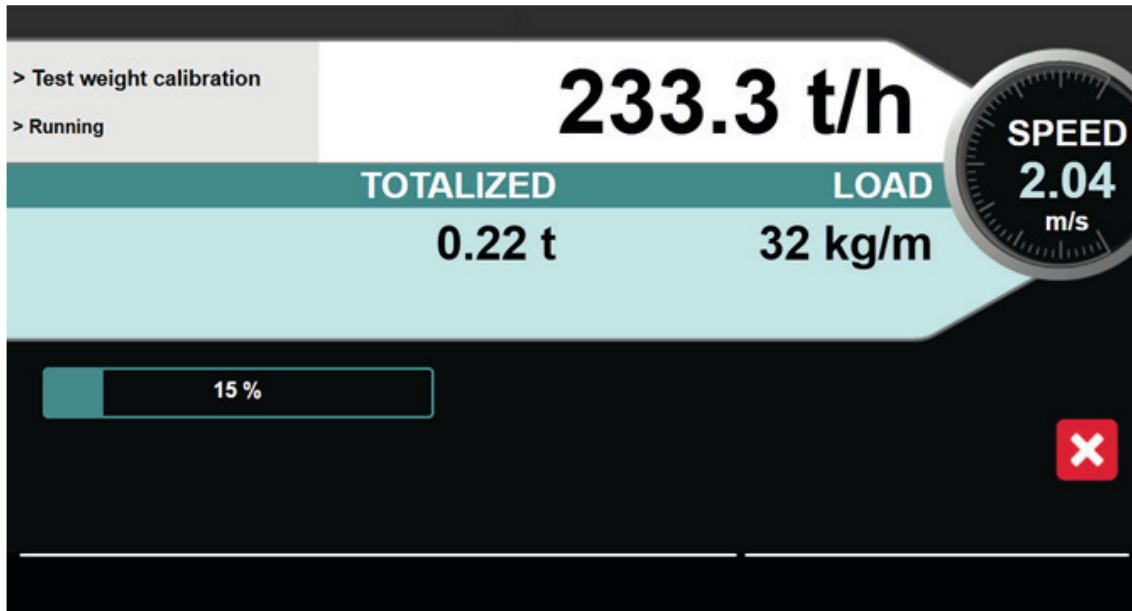

Figure 3-6. Test Weight Calibration Progress Bar

- Select the **ACCEPT** button to use the new calculated correction.

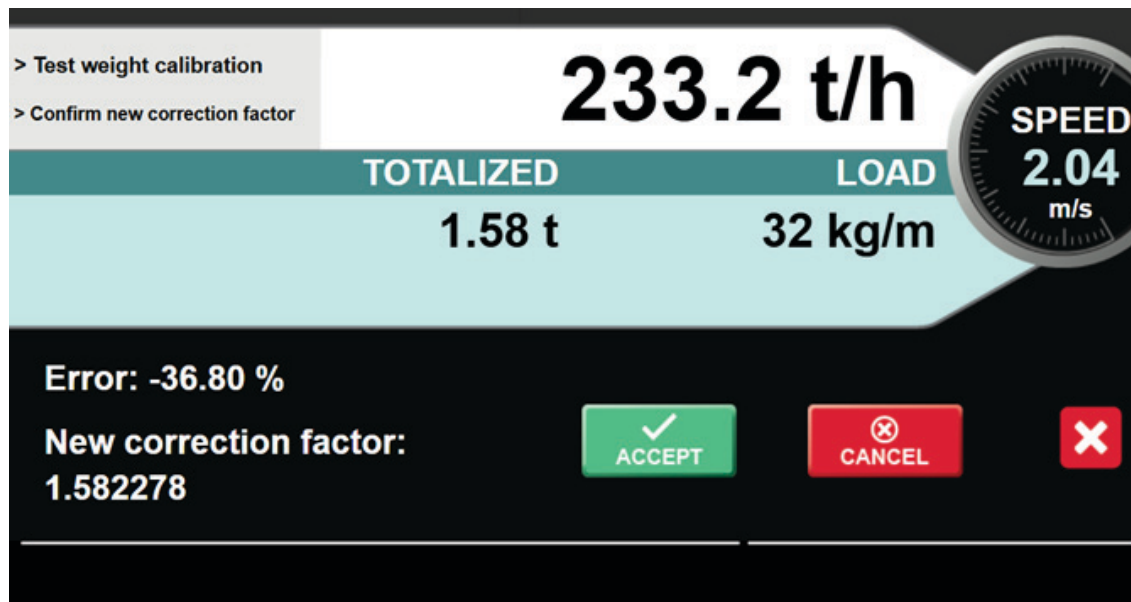

Figure 3-7. New Calculated Correction Factor

- Program returns to Main Display and shows weight information with the new Correction Factor.

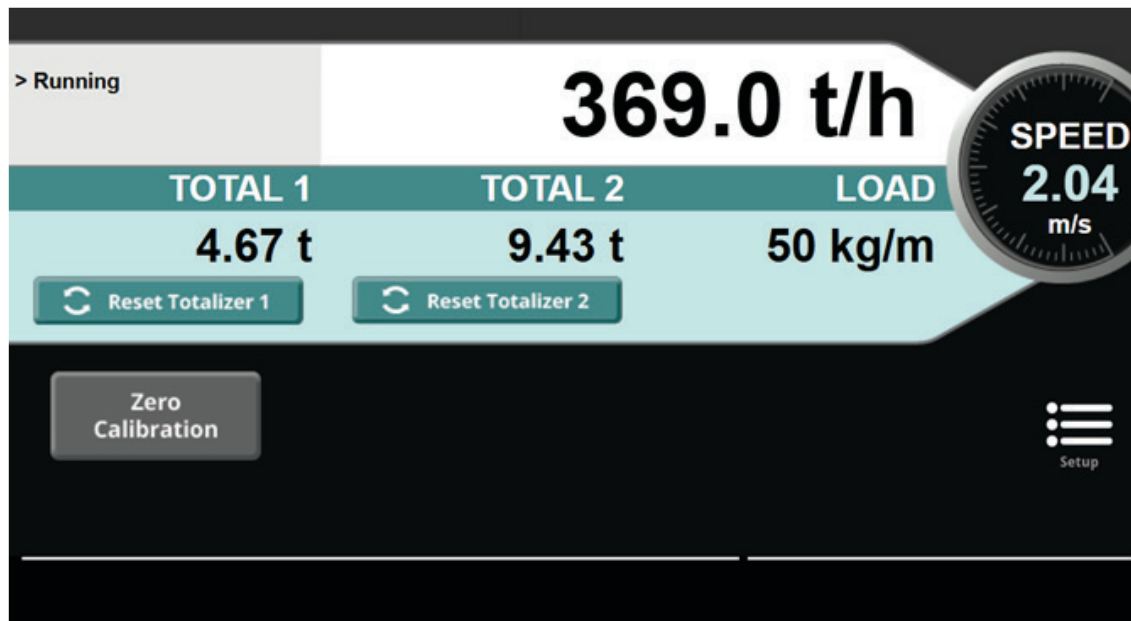

Figure 3-8. New Main Display

3.2 BulkSlide Calibration



IMPORTANT: At a minimum, the following settings must be properly configured to match your BulkSlide device specifications before performing calibration.

Calibrate the following:

- Initial Settings (see [Section 2.2 on page 8](#)):
 - Select Metric or US (Save and Exit before making other changes to configuration)
 - Select BulkSlide (Save and Exit before making other changes to configuration)
- Calibration Parameters (see [Section 2.6 on page 10](#)):
 - Capture Static Zero by entering Zero mV value or capturing Zero mV value with the SCT-4XD Digitizer (see the Zero Scale section in the SCT-4XD Technical Manual for further instructions)
 - Configure Load cell Capacity
 - Configure Load cell sensitivity

Perform the following to calibrate:

1. Perform [Step 1](#) through [Step 3](#) of the Test Weight Calibration Procedure to capture the Dynamic Zero.
2. Select the **Reset Totalizer 1** button.
3. Confirm the reset request.
4. Process the same material through the BulkSlide at least 3 times, using Totalizer 1 to ensure repeatability. Clear Totalizer 1 after each run.
5. Post-weigh or pre-weigh the amount of material and record the Totalizer 1 value.
6. Use the following formula to calculate the new Correction Factor using the Weight of the material and the recorded Totalizer 1 value.

$$\text{New Correction Factor} = (\text{Actual Weight of Material} / \text{Displayed Weight of Material}) \times \text{previous Correction Factor}$$
7. In the Setup menu under Calibration Parameters, enter the New Correction Factor in the Correction factor field.

Program: 1280 SCTX Belt PN224092 1.00			
Calibration Parameters			
Number of channels	Weigh length	Belt angle	Zero range
1	1000 mm	0.0 °	10.0 %
Loadcell capacity	Pivot to LC distance	Correction factor	Auto zero range
200.000 kg	0 mm	1.582278	0.0 %
Loadcell sensitivity	Pivot to idler dist.	Belt length	Auto zero limit
2.00000 mV/V	0 mm	10.0 m	0.0 %
Loadcell zero mV/V	Serial inclinometer	Zero revolutions	Test weight calibration
0.00000 mV/V	No	1	...

Figure 3-9. New Correction Factor

3.3 Analog Output

The 1280 HMI can transmit the SCT-4XD flow rate out of an analog output card assigned to any available slot.

- Set Source to Programmability.
- Set Maximum Value Tracked to the Max Flow Rate of the SCT-4XD.

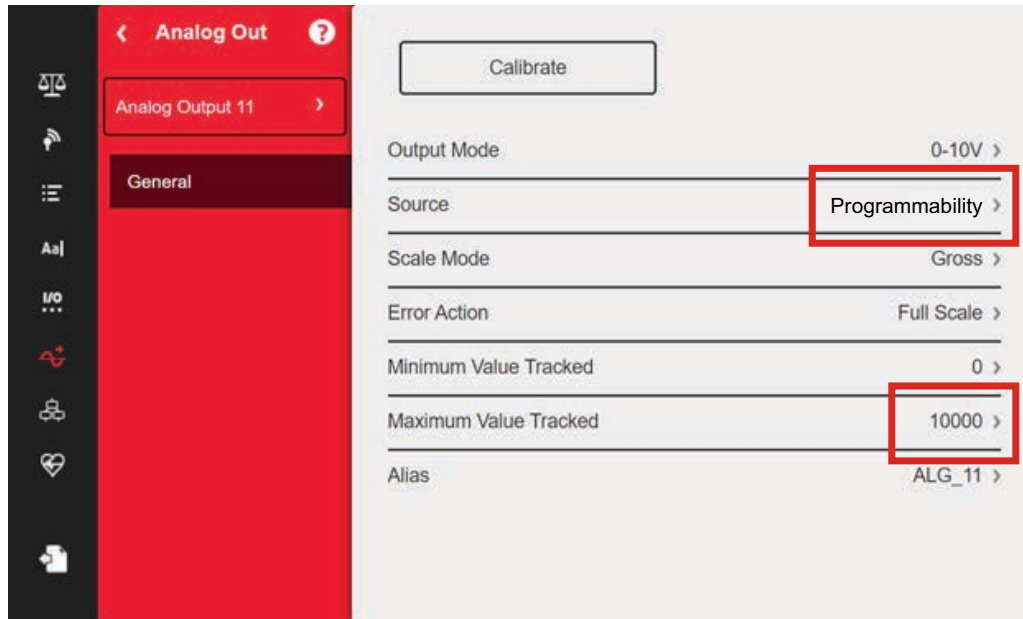

Figure 3-10. Analog Output Card Settings

3.4 Communications

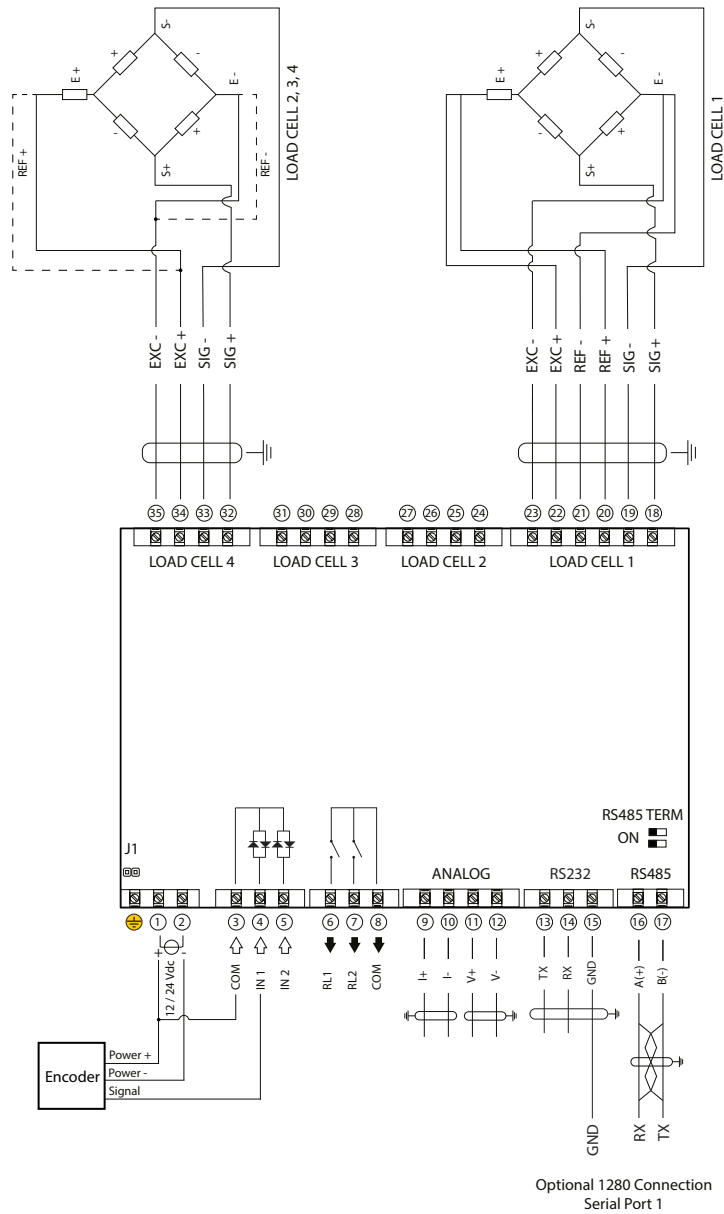

Figure 3-11. 1280 HMI Fieldbus Wiring Diagram

Port	Type	Description	Setup
1	PROGIN	SCT-4XD	9600,8,N,1 RS-485 Duplex: Half Address: 0 Echo: Off Response: Off

Table 3-1. Serial Port

4.0 Fieldbus

4.1 1280 HMI Configuration

Set the iRite Fieldbus Data Size to:

- 32 for Profibus and Profinet
- 36 for all other protocols

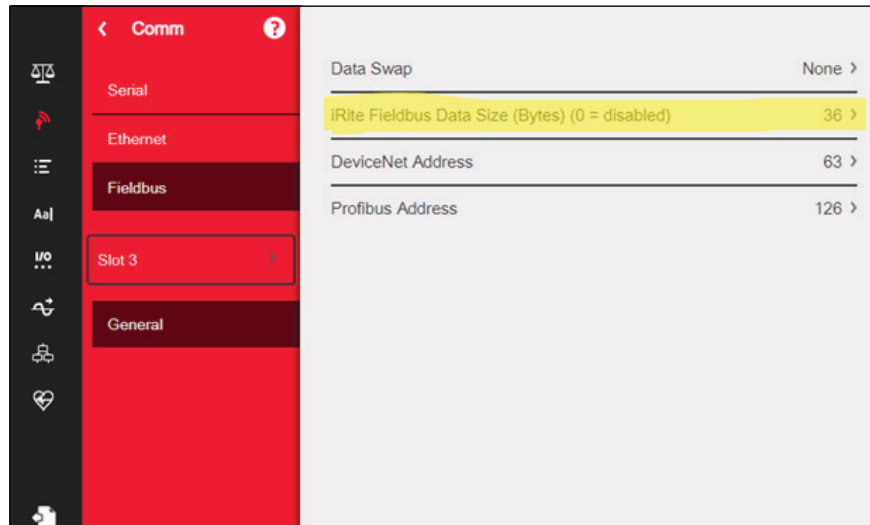

Figure 4-1. 1280 HMI Fieldbus Configuration

4.2 Database

The 1280 HMI can log the SCT-4XD Totalizer 1 to a USB drive as a text (*.txt) file. To trigger the file:

1. Configure up to 4 Time of Day setpoints (SP1, SP2, SP3, SP4).
2. Set desired time for each setpoint.
3. Leave duration at default of 0:01:00.

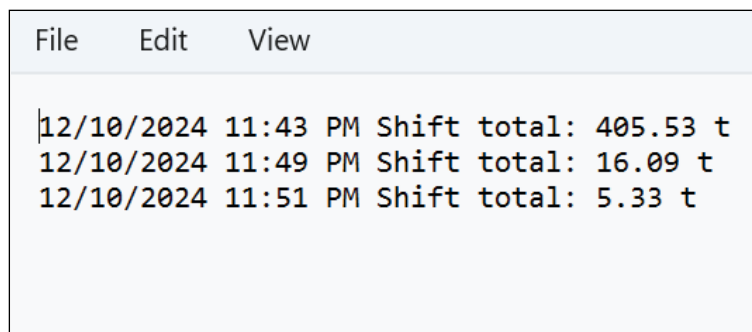

Figure 4-2. Sample Text File Output

4.3 Input Register

Data from 1280 HMI to PLC.

Word Addr.	Word Contents	Word Type	Bit Addr.	Description
30001	Belt status	Integer number	0-7	Error code: 0 = No error 1 = Off track 2 = Min flow rate alarm 3 = Max flow rate alarm 4 = Zero flow rate 5 = Weight alarm 6 = Off track lock 7 = Min flow rate lock 8 = Max flow rate lock 9 = Dosage weight lock 10 = Lock due to input ON/OFF or Enable 11 = Weight lock 12 = External alarm 13 = External alarm lock 14 = Flow rate lock
		Integer number	12-15	Belt state: 0 = Alarm 1 = Manual (Input ON/OFF open) 2 = Wait (Input Enable closed) 3 = Pause 4 = (Not used) 5 = Run 6 = (Not used) 7 = (Not used) 8 = Lock 9 = Zero belt active 10 = Test weight procedure active
30002	Flow rate	Integer number		See 30015 for the decimals
30003	Load (High word)	Integer number		With 3 decimals
30004	Load (Low word)	Integer number		With 3 decimals
30005	Belt speed 1	Integer number		With 2 decimals
30006	Belt speed 2	Integer number		With 2 decimals
30007	Total 1 (High word)	Integer number		See 30015 for the decimals
30008	Total 1 (Low word)	Integer number		See 30015 for the decimals
30009	Total 2 (High word)	Integer number		See 30015 for the decimals
30010	Total 2 (Low word)	Integer number		See 30015 for the decimals
30011	mV channel 1	Integer number		With 3 decimals
30012	mV channel 2	Integer number		With 3 decimals
30013	mV channel 3	Integer number		With 3 decimals
30014	mV channel 4	Integer number		With 3 decimals
30015	Decimals Total (High byte)	Integer number		
	Decimals Total (Low byte)	Integer number		
30016	Units Total (High byte)	Integer number		1 = kg 2 = t 3 = lb
	Units Total (Low byte)	Integer number		1 = kg/h 2 = t/h 3 = lb/h

Table 4-1. Input Registers

Word Addr.	Word Contents	Word Type	Bit Addr.	Description
30017	Channel error, encoder active, polarity load and flow	Discrete bits (active high)	0 1 2 3 4 5 6 7	Flow polarity: 0 = +, 1 = - Load polarity: 0 = +, 1 = - Encoder 1 active Encoder 2 active Channel 1 error Channel 2 error Channel 3 error Channel 4 error
30018	Not used			

Table 4-1. Input Registers (Continued)



© Rice Lake Weighing Systems Content subject to change without notice.

230 W. Coleman St. • Rice Lake, WI 54868 • USA USA: 800-472-6703 • International: +1-715-234-9171