

New Pricing

Effective July 1

Precision Solutions

RICE LAKE
WEIGHING SYSTEMS

Edition

1



Sections

- 1** Calibration Services
- 16** ASTM Mass Reference Standards
- 60** OIML Mass Reference Standards
- 82** ASTM Balance Calibration Weights
- 90** ASTM Stainless Steel Field Weights
- 108** ASTM Cast Iron Field Weights
- 116** ASTM Specialty Calibration Weights
- 126** Accessories & Cases
- 132** Balances
- 236** Reference





1

Calibration Services

- 2** Complete Calibration Services
State and International Reciprocity
- 3** Rice Lake Weighing Systems' Metrology Labs
Customer Relations
Order and Customer Service
Metrology Lab Teams
- 4** What is Traceability?
- 6** Packaging Weights
- 7** Weight Handling Procedure
Contact Us
- 8** Documentation
What Type of Documentation Do I Need for My Weights?
Legal for Trade Weight Applications
New Weights
- 9** Certificate Quick Look
- 10** Certificate of Weight Calibration (Accredited)
- 12** Certificate of Weight Calibration (Non-accredited)
- 14** Statement of Accuracy
- 15** Rice Lake Certificate Selection Guide

Complete Calibration Services

Rice Lake Weighing Systems offers comprehensive calibration services through its two ISO/IEC 17025 accredited metrology labs in Rice Lake, WI and Concord, CA. Together, these laboratories provide state-of-the-art services that promise advanced metrology expertise and a commitment to customer service through continuous improvement. Our two accredited labs offer a full selection of calibration weights, accessories and services. Our metrologists can certify weights to ASTM E617 accuracy classes 00-7; OIML R111-1 accuracy classes E1-M3. To satisfy calibration needs, Rice Lake offers certificates that fulfill various tiers of industry requirements.



AZLA Cert. No. 4363.01
AZLA Cert. No. 1823.01



NVLAP Lab Code 105001-0
NVLAP Lab Code 600169-0

Rice Lake's combined, 100+ years of metrology expertise is continually built on by staff who participate in NIST/OWM training seminars, regional metrology groups and round-robin measurement forums, for related upgrades in technology and calibration tools. Additionally, Rice Lake's Concord lab, formerly known as Heusser Neweigh, is active in the NIST Western Regional Measurement Assurance Program (WRAP), the National Conference of Standards Laboratories International (NCSL International) and the American Society for Quality (ASQ). Today, Rice Lake Weighing Systems is accredited by NVLAP to conduct calibrations that are equal to the services provided by state labs.

State and International Reciprocity

With state-granted reciprocity, Rice Lake can calibrate and ship NVLAP-accredited calibration weights to any state lab with a reciprocity agreement. NVLAP is the nation's premier calibration accreditation program, however, individual states have the ability to adopt or reject NVLAP based on state regulatory culture. When state reciprocity is a possible obstacle to your calibration needs, Rice Lake will work directly with those states' labs to get your Legal for Trade test weights and mass standards back into service.

For international customers, NVLAP-accredited calibration validates the traceable link to the international standard (SI) that is frequently required by ISO 9001 registered companies. NVLAP standards comply with and are tailored to the international documentary standards of ISO/IEC 17025 and ILAC requirements. This degree of equivalency between metrology labs in the United States and Europe simplifies calibration efforts for organizations that need the strictest scope of conformity for an international geographical region.

Rice Lake Weighing Systems' Metrology Labs



Rice Lake, WI
Concord, CA

Our metrology labs in Rice Lake, WI and Concord, CA both calibrate any brand of precision or industrial weight with a four-day turnaround.

Both labs are ISO/IEC 17025 accredited for their measurement capabilities. Accreditation brings an unbiased, third party evaluation of our measurement and technical capabilities ensuring you receive the most accurate and reliable calibration results.



Milan, Italy

CIBE S.R.L. Weights and Measures Laboratory For over 30 years, the CIBE metrology laboratory has specialized in offering testing, calibration and certification services for mass reference standards, weights and weighing instruments. Accredited by ACCREDIA in Italy and Europe for calibration and periodic verification.

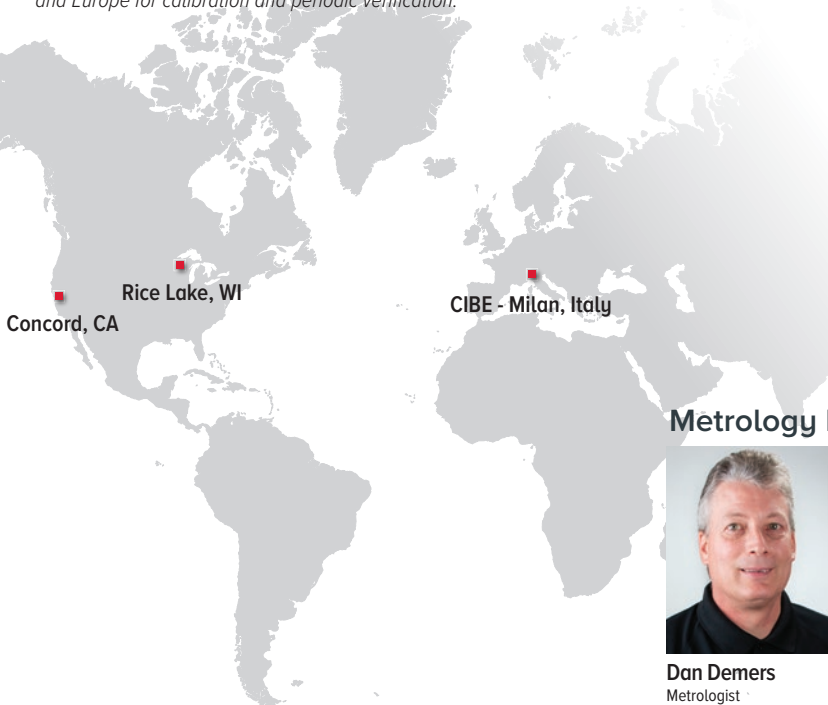

Customer Relations



Brian Gourley
Product Manager



Deanna Stanley
Inside Sales Manager



Mark Ruefenacht
Technical Director



Dylan Callahan
Operations Manager

Order and Customer Service



Eric Butzler



Becky Clausen



Sonya Hegle



Beck Morgan



Jason Mathews



K C Peterson



Ray Pumala



Ali Richter



Lynnette Thompson



Kally Wagner



Stacie Lashmett-Stoeberl

Metrology Lab Teams



Dan Demers
Metrologist



David Wingo
Metrologist



Mike Arrigoni
Lab Supervisor



Heather Fenske
Lab Assistant

What is Traceability?

Traceability is documentation proving a direct link to the official U.S. one kilogram weight standard housed at the National Institute of Standards and Technology (NIST). NIST standards are calibrated to the international one kilogram weight standard maintained at the International Bureau of Weights and Measures (BIPM).

Traceability not only means that a weight or mass standard has links to the one kilogram standard, but also that the measurements are appropriate for the accuracy class required for the application. Traceability also requires proof that all environmental factors affecting accuracy were considered at the lab performing the measurement.



MEASURAND

CHAIN OF TRACEABILITY



Realization of BIPM

Unbroken Chain of Comparisons

Measurement Uncertainty

Measurement Assurance

Competence

Documentation

Periodic Recalibration



WEIGHING INSTRUMENT

CUSTOMER WEIGHTS



RICE LAKE'S CALIBRATION LABORATORIES

NATIONAL METROLOGY INSTITUTE (NIST)

INTERNATIONAL SYSTEM OF UNITS (SI)

★ Rice Lake Calibration Laboratory - Concord, CA

★ Rice Lake Calibration Laboratory - Rice Lake, WI

★ National Metrology Institute (NIST) Gaithersburg, MD

★ Bureau International des Poids et Mesures - Paris, France

★ Rice Lake Calibration Laboratory CIBE - Milan, Italy



Weight Handling Procedure

- All weights and cases are inspected for damage and scheduled for calibration upon arrival to the lab.
- All stickers and markers are removed from the weights.
- Precision weights receiving accredited calibration are checked for magnetism.
- A maximum permissible error test is conducted.
- Any follow up with the client is completed.

Mass Standards Expectations

- Weights should be clean and in good repair.
- Weights shall be identified with a permanent serial number or mark into the surface of the weight.
- Stickers and markers are not allowed and will be removed. The added mass of the sticker may change the mass of the weight, possibly causing the weight to be out of tolerance which will invalidate the reported value on the certificate.
- Individual weight kits shall also be identified with unique serial numbers.
- Cast iron weights should have no evidence of rust, loose paint or adhering debris.
- Analytical weights should be handled carefully. Tolerances are small, so dirt or abuse can throw them out of tolerance.
- Any cleaning, repair or painting of standards in the metrology lab will incur an extra charge.

Case Conditions

- Interior of cases for weight kits should also be wiped out or vacuumed.
- Cases should be sound with secure latches.

Contact Us

Your existing calibration weights and weight sets should be recertified on a managed periodic basis determined by a number of factors, including but not limited to the environment, frequency of use, demands of the process, quality of the weighing device in question, age of the weights in question and handling during use.

Coast to coast, Rice Lake Weighing Systems will calibrate any of your current calibration weights or weight sets. To accurately estimate the cost of our calibration services, we offer the following four-hour response options:

Online

Complete and email the Weight Recalibration Request form found at www.ricelake.com/recalibration to orderdesk@ricelake.com

Mail

Return the "Weight Recalibration Request Form" on page 283 found in the reference section of the catalog or download the form online at www.ricelake.com/metrologyservices. Once we receive your request, we will call you with a quote.

Phone

Call 800-472-6703 to discuss your needs and receive a quote.

Weight Recalibration Request forms must be received between the hours of 6:30 a.m. and 6:30 p.m., Monday through Friday and 8:00 a.m. to noon (Central Time) on Saturday.

Replacement documentation is provided free of charge if reported lost within 60 days of the date of the original document. After 60 days, a fee of \$50.00 plus shipping will be charged.



Documentation

Rice Lake's labs in California and Wisconsin offer two types of weight documentation: accredited and non-accredited. An accredited document is ISO/IEC 17025 accredited through NVLAP and A2LA. Measurements are traceable to the SI through NIST.

Rice Lake offers one accredited document:

- **Certificate of Weight Calibration**

Rice Lake offers two non-accredited documents:

- **Certificate of Weight Calibration**
(non-accredited but measurements are traceable to the SI through NIST)
- **Statement of Accuracy**
(non-accredited and not traceable to NIST)

What Type of Documentation Do I Need for My Weights?

Depending on the class of weight being evaluated, different documentation may be needed. Refer to any programs or guidelines within your company or the Accuracy Classes for Mass Standards and Test Weights chart below can be used as a guide to define whether an accredited or non-accredited Certificate of Weight Calibration is required.

A Statement of Accuracy is adequate if the actual values and stated uncertainties of the weights are not necessary, and only the tolerances of the specific class are needed. These documents are normally adequate for weights used to calibrate industrial balances and scales more than 6 kilograms in capacity. The mass standards used by both labs are used to verify that those weights are within the necessary tolerances. Weights with this document do not meet the requirements needed in Legal for Trade applications.

Legal for Trade Weight Applications

ASTM and OIML weights are required for Legal for Trade applications which include any product that is sold by weight.

New Weights

To order documentation with your purchase of a new weight or weight set, please note on your purchase order to add documentation and then call or fax the order to have the additional price quoted immediately.

Accuracy Classes

Current Standard and Test Weight Accuracy Classes			Historical Classes	
Typical Use	OIML ¹	ASTM E617 ²	NIST 105-1 ³	NBS CIR. 547 ³
Certificate of Weight Calibration (Accredited) Is Recommended for...				
Primary Laboratory Reference Standard High precision standards for calibration of weights and special precision analytical balances accuracy Classes I and II (class number depending on precision).	E1	00		
	E2			
		0 and 1		M and S
Certificate of Weight Calibration (Non-accredited) Is Recommended for...				
High Accuracy Balances Working standard for precision analytical work, built-in weights and external weights used to calibrate moderate precision balances.	F1	2		
		3		S1
	F2			
Statement of Accuracy Is Acceptable for...				
Industrial Scales and Balances Accuracy Class III industrial scales, dial scales, trip balances, platform scales. Also used for accuracy Class III L and III L, and weights used to calibrate scales in Legal for Trade applications.		4		P
	M1	5		Q
	M2	6	F	T
	M3	7		

¹For more information on OIML Weight Classifications see page 240

²For more information on ASTM Weight Classification see page 242 (ASTM E617)

³Listed for reference only. NBS Cir. 547 has been superseded by ASTM E 617 classifications

NOTE: All NIST Class F 2020 are acceptable as NIST Class F providing they meet the criteria defined in NIST Handbook 105-1 2019

Certificate Quick Look



Certificate of Weight Calibration (accredited)

- Meets requirements for ISO/IEC 17025 and ANSI/NCSL Z540-1
- Measurements are traceable to the SI through NIST
- Contains the assumed density of the weight being tested so that atmospheric buoyancy corrections can be applied
- Lists the uncertainty of the measurement process as it relates to the item being calibrated
- Lists the actual mass values or the corrections to the nominal mass of the weight being calibrated vs. 8 grams/cm³
- Lists the environmental conditions present at time of calibration
- Cites that the test was done by Rice Lake's accredited laboratories
- States that Rice Lake is ISO 9001 registered

Certificate of Weight Calibration (non-accredited)

- Measurements are traceable to the SI through NIST
- Not an accredited certificate
- Contains the assumed density of the weight being tested so that atmospheric buoyancy corrections can be applied
- Lists the uncertainty of the measurement process as it relates to the item being calibrated
- Lists the actual mass values or the corrections to the nominal mass of the weight being calibrated vs. 8 grams/cm³
- Lists the environmental conditions present at time of calibration
- Cites that the test was done by Rice Lake's laboratories

Statement of Accuracy

- Does not provide traceability to NIST
- All weight classes - except E1, E2, 0, 00
- This is not a Legal for Trade or traceable document
- Tolerance statement of the weight
- Nominal value of the weight is listed
- Tolerance for the specific weight class is noted
- Before, after or uncertainty values are not listed



Certificate of Weight Calibration (Accredited)

A customer requesting an accredited Certificate of Weight Calibration needing traceability to NIST is looking for a nominal mass value plus or minus corrections and uncertainty values. To produce this document, a calibration laboratory must maintain a statistical measurement process acceptable by the accrediting body. Also, depending on the weight class and the accuracy required, different standards and procedures need to be incorporated to make sure the level of uncertainty is appropriate for the item being calibrated. The accredited Certificate of Weight Calibration is in compliance with ISO International Standard 17025 and ANSI/NCSL Z540-1 requirements.

RICE LAKE		Certificate of Weight Calibration		ISO/IEC 17025 & ANSI/NCSL-Z540-1-1994 ACCREDITED	
Traceable Certificate Number:	1234567	1			
Contractor:	RICE LAKE WEIGHING SYSTEMS 230 W. COLEMAN STREET RICE LAKE, WI 54868	2			
Purchase Order Number:	PURCHASE ORDER	3			
Client:	RICE LAKE WEIGHING SYSTEMS 230 W. COLEMAN STREET RICE LAKE, WI 54868				
Date Received:	01 Jul 2020	4			
Date Calibrated:	01 Jul 2020 to 02 Jul 2020	5			
Recalibration Date:	01 Jul 2021				
NIST Certificate Number:	684/291344-18 & 684/292805-19	6			
If there are two NIST numbers, one or both may apply					
Calibrated By:	01, 02	7			
Procedure:	WI05-0095 Rev. D				
Condition of Weights:	Acceptable for Calibration	8			
Description of Weights:	5 mg to 200 g Polished Weight Kit, ASTM Class 1, S/N ABCD				
Comments:					
		Key Notes		Cleaning Levels	
Finish	✱ Indicates the weight does not meet the finish requirements			A	Dusted with brush or cloth
Material	⊕ Indicates the weight does not meet the material requirements			B	Spot cleaned with ethyl alcohol
New Wt	◇ Indicates new weight			C	Full surface cleaned with ethyl alcohol
Missing Wt	△ Indicates replaced missing weight with new weight			D	Spot cleaned with non-alcohol solvent followed by ethyl alcohol
Damaged Wt	✂ Indicates replaced damaged weight			E	Full surface cleaned with non-alcohol solvent followed by ethyl alcohol
Replaced OOT	★ Indicates replaced out of tolerance weight			F	No cleaning performed
OOT	⊗ Indicates correction plus or minus Uncertainty greater than or equal to MPE			Material Abbreviations	
Magnetic Wt	★★ Indicates replaced magnetic weight			AL	Aluminum
Design	⊗ Indicates the weight does not meet the design or shape requirements			TA	Tantalum
Repainted	⬇ Indicates the weight was repainted after As Found obtained			SS	Stainless Steel
Other	⊕ See comments above			BR	Brass
				CI	Cast Iron
				PL	Platinum
				IR	Iron
				NS	Nickel Silver
				MS	Mid Steel
				OR	Other/Unknown
<p>Check with your local state agency for certification of compliance on Legal-for-Trade items. The weight accuracy class is referenced in the Description of Weights. Unless otherwise noted, the weights calibrated meet the requirements of the accuracy class. Results relate only to weights calibrated. The Surface Finishes of weights are evaluated visually. Weights are screened for magnetism using work instruction WI05-0035 when they are new, when requested by the customer or when weights are suspected of not meeting specifications. Density if measured is measured using OIML R111-1 (2004) method A2. Conventional Mass is reported based on a reference density of 8.0 g/cm³. The Uncertainty of Measurement is included in the determination of Maximum Permissible Error (MPE) Pass/Fail Criteria. The specifications for Maximum Permissible Error (MPE) can be found in NIST Handbook 105-1 (2019), NIST Handbook 105-1 (1990), ASTM E617-18 or OIML R111-1 (2004), manufacturer specifications or customer specifications.</p> <p>The Uncertainty assigned to the Conventional Mass values are the result of the root-sum-square of the type A and type B components, calculated in accordance with NIST SOP 29 and the Guide to the expression of uncertainty in measurement, with coverage factor (k=2), to express the expanded uncertainty with an approximate 95.45% confidence level. This report is not to be used to claim product certification, approval, or endorsement by NVLAP, NIST, A2LA, or any government agency. This document shall not be reproduced, except in full, without the written approval of Rice Lake Weighing Systems.</p>					
 Dan Demers, Metrologist		10 Jul 2020 Date:			
9	 CALIBRATION NVLAP LAB CODE 10501-0	10	Prepared By: Rice Lake Weighing Systems® • PN 64764•06/20 230 West Coleman Street • Rice Lake, WI 54868 • USA TEL: 715-234-9171 • FAX: 715-234-6967 Definitions: http://certs.ricelake.com/certs/DefinitionsV2.docx Page 1 of 2	  Certificate #4393.01	

Procedure Used:
Internationally published procedures defined by NIST, ASTM and OIML

The Certificate of Weight Calibration (accredited) includes the following information:

- 1** Traceable report number
- 2** Contractor (sold to) name and address
- 3** Client (shipped to) name and address
- 4** Date calibrated
- 5** Recall date (if requested)
- 6** NIST certificate of calibration
- 7** Procedure used Intercomparison Method
- 8** Identification of the calibrated item and serial number, if applicable
- 9** The NVLAP and A2LA official logo will be displayed when the documentation meets the scope of accreditation
- 10** Name and address of the calibration laboratory
- 11** Nominal conventional mass
- 12** Conventional Mass As Found - mass that weighs at 20 °C in air of density of 1.2 milligram/cm³ against a standard density of 8.0 gram/cm³
- 13** Conventional mass correction of the weight before adjustment¹
- 14** Conventional Mass As Left - mass that weighs at 20 °C in air of density of 1.2 milligram/cm³ against a standard density of 8.0 gram/cm³
- 15** As left conventional mass correction of the weight¹
- 16** A statement of the estimated value of uncertainty²
- 17** Maximum permissible error for the specific accuracy class
- 18** Assumed density of the weight being calibrated
- 19** Environmental condition at time of calibration
- 20** Record of the weighing equipment
- 21** Reference standard set used to calibrate items listed on report

1 The Conventional Mass Correction is the deviation from the Nominal Value, reported in milligrams. A minus sign indicates that the weight is less than the nominal value.

2 All measurements have a degree of uncertainty regardless of precision and accuracy. This is caused by two factors, the limitation of the measuring instrument (systematic error) and the skill of the experimenter making the measurements (random error).

RICE LAKE		Certificate of Weight Calibration										ISO/IEC 17025 & ANSI/NCSL-Z540-1-1994 ACCREDITED				
Traceable Certificate Number: 1234567		Client: RICE LAKE WEIGHING SYSTEMS										Temperature Range: 19 20.93°C to 21.00 °C				
Date Calibrated: 01 Jul 2020 to 02 Jul 2020		Pressure Range: 728.79 mmHg to 729.87 mmHg										Relative Humidity Range: 49 % to 52 %				
As Left Data (As Found only shown when different than As Left)																
11	12	13	14	15	16	17	18	19	20	21	22	23	24	25	26	27
Nominal Value	Unique ID	True Mass	True Mass Corr. (mg)	Conv. Mass	Conv. Mass Corr. (mg)	(k=2) Unc. (± mg)	MPE (± mg)	MP Pass	Assumed Density (g/cm ³)	Assumed Material	Const. Type	Balance Used	Reference Standard Set Used	Air Density (mg/cm ³)	Clean Level	
5 mg		4.99940	-0.00060	4.99939	-0.00061	0.00084	0.010	Y	7.95	SS	I	503Q	L595Q	1.1474	A	
20 mg		20.00116	0.00116	20.00114	0.00114	0.00087	0.010	Y	7.95	SS	I	503Q	L595Q	1.1471	A	
20 mg		20.00115	0.00115	20.00113	0.00112	0.00087	0.010	Y	7.95	SS	I	503Q	L595Q	1.1472	A	
50 mg		50.0027	0.0027	50.0026	0.0026	0.0011	0.010	Y	7.95	SS	I	503Q	L595Q	1.1469	A	
100 mg		99.9984	-0.0016	99.9983	-0.0017	0.0014	0.010	Y	7.95	SS	I	503Q	L595Q	1.1470	A	
200 mg		199.9974	-0.0026	199.9972	-0.0028	0.0014	0.010	Y	7.95	SS	I	503Q	L595Q	1.1470	A	
200 mg		199.9977	-0.0023	199.9975	-0.0025	0.0014	0.010	Y	7.95	SS	I	503Q	L595Q	1.1469	A	
500 mg		499.9965	-0.0035	499.9960	-0.0040	0.0014	0.010	Y	7.95	SS	I	503Q	L595Q	1.1466	A	
2 g		2.0000016	0.0016	2.0000027	0.0027	0.0023	0.034	Y	8.03	SS	II	650Q	L595Q	1.1470	A	
2 g		2.0000098	0.0098	2.0000109	0.0109	0.0023	0.034	Y	8.03	SS	II	650Q	L595Q	1.1469	A	
5 g		5.0000065	0.0065	5.0000093	0.0093	0.0046	0.034	Y	8.03	SS	II	650Q	L595Q	1.1469	A	
10 g		9.9999517	-0.0483	9.9999573	-0.0427	0.0059	0.050	Y	8.03	SS	II	1958Q	L595Q	1.1480	A	
20 g		19.9999780	-0.0220	19.9999892	-0.0108	0.0056	0.074	Y	8.03	SS	II	1958Q	L595Q	1.1479	A	
20 g		19.9999828	-0.0172	19.9999940	-0.0060	0.0056	0.074	Y	8.03	SS	II	1958Q	L595Q	1.1476	A	
50 g		49.999961	-0.039	49.999969	-0.011	0.011	0.12	Y	8.03	SS	II	1958Q	L595Q	1.1476	A	
100 g		99.999817	-0.183	99.999873	-0.127	0.021	0.25	Y	8.03	SS	II	1958Q	L595Q	1.1478	A	
200 g		199.999942	-0.058	200.000054	0.054	0.045	0.50	Y	8.03	SS	II	699Q	L595Q	1.1431	A	
200 g		199.999862	-0.138	199.999874	-0.026	0.045	0.50	Y	8.03	SS	II	699Q	L595Q	1.1429	A	

Certificate of Weight Calibration (Non-accredited)

A customer requesting a non-accredited Certificate of Weight Calibration, needs proof of traceability to NIST and actual values and uncertainties. Comparisons must be made between the item being calibrated and the standard being used. The mass reference standard used for the tolerance test is essential to the traceable document.

Prior to comparison between the known standard and the item submitted for calibrating, the known standard must be sufficiently calibrated over time to produce predictable measurements.

This certificate should contain all of the data related to the calibration. After calibrating, a non-accredited Certificate of Weight Calibration is issued. Although the Certificate of Weight Calibration (non-accredited) provides traceability to NIST, it is not a NVLAP accredited document. If an accredited document is required, please refer to the Certificate of Weight Calibration (accredited) on the previous page.

RICE LAKE		Certificate of Weight Calibration	
Traceable Certificate Number:	1234567	1	
Contractor:	RICE LAKE WEIGHING SYSTEMS 230 W. COLEMAN STREET RICE LAKE, WI 54868	2	
Purchase Order Number:	PURCHASE ORDER	3	
Client:	RICE LAKE WEIGHING SYSTEMS 230 W. COLEMAN STREET RICE LAKE, WI 54868		
Date Received:	01 Jul 2020	4	
Date Calibrated:	01 Jul 2020 to 02 Jul 2020		
Recalibration Date:	01 Jul 2021	5	
NIST Certificate Number:	684/291344-18 & 684/292805-19	6	
If there are two NIST numbers, one or both may apply			
Calibrated By:	01, 02		
Procedure:	WI05-0095 Rev. D	7	
Condition of Weights:	Acceptable for Calibration		
Description of Weights:	5 mg to 200 g Polished Weight Kit, ASTM Class 1, S/N ABCD	8	
Comments:			
Key Notes		Cleaning Levels	
Finish	✱ Indicates the weight does not meet the finish requirements	A	Dusted with brush or cloth
Material	⊕ Indicates the weight does not meet the material requirements	B	Spot cleaned with ethyl alcohol
New Wt	◇ Indicates new weight	C	Full surface cleaned with ethyl alcohol
Missing Wt	△ Indicates replaced missing weight with new weight	D	Spot cleaned with non-alcohol solvent followed by ethyl alcohol
Damaged Wt	✱ Indicates replaced damaged weight	E	Full surface cleaned with non-alcohol solvent followed by ethyl alcohol
Replaced OOT	✱ Indicates replaced out of tolerance weight	F	No cleaning performed
OOT	⊗ Indicates correction plus or minus Uncertainty greater than or equal to MPE	Material Abbreviations	
Magnetic Wt	★ Indicates replaced magnetic weight	AL	Aluminum
Design	⊗ Indicates the weight does not meet the design or shape requirements	TA	Tantalum
Repainted	■ Indicates the weight was repainted after As Found obtained	SS	Stainless Steel
Other	↑ See comments above	BR	Brass
		CI	Cast Iron
		IR	Iron
		MS	Mild Steel
		PL	Platinum
		NS	Nickel Silver
		OR	Other/Unknown

Check with your local state agency for certification of compliance on Legal-for-Trade items. The weight accuracy class is referenced in the Description of Weights. Unless otherwise noted, the weights calibrated meet the requirements of the accuracy class. Results relate only to weights calibrated. The Surface Finishes of weights are evaluated visually. Weights are screened for magnetism using instruction WI05-0035 when they are new, when requested by the customer or when weights are suspected of not meeting specifications. Density if measured is measured using OIML R111-1 (2004) method A2. Conventional Mass is reported based on a reference density of 8.0 g/cm³. The Uncertainty of Measurement is included in the determination of Maximum Permissible Error (MPE) Pass/Fail Criteria. The specifications for Maximum Permissible Error (MPE) can be found in NIST Handbook 105-1 (2019), NIST Handbook 105-1 (1990), ASTM E617-18 or OIML R111-1 (2004), manufacturer specifications or customer specifications.

The Uncertainty assigned to the Conventional Mass values are the result of the root-sum-square of the type A and type B components, calculated in accordance with NIST SOP 29 and the Guide to the expression of uncertainty in measurement, with coverage factor (k=2), to express the expanded uncertainty with an approximate 95.45% confidence level. This report is not to be used to claim product certification, approval, or endorsement by NVLAP, NIST, A2LA, or any government agency. This document shall not be reproduced, except in full, without the written approval of Rice Lake Weighing Systems.

10 Jul 2020
Date:

Prepared By:
9 Rice Lake Weighing Systems® • PN 64784•06/20
230 West Coleman Street • Rice Lake, WI 54868 • USA
TEL: 715-234-8171 • FAX: 715-234-8967
Definitions: <http://certs.ricelake.com/certs/DefinitionsV2.docx>
Page 1 of 2

Procedure Used:
Internationally published procedures defined by NIST, ASTM and OIML

The Certificate of Weight Calibration (non-accredited) includes the following information:

- 1** Traceable report number
- 2** Contractor (sold to) name and address
- 3** Client (shipped to) name and address
- 4** Date calibrated
- 5** Recall date if requested
- 6** NIST certificate of calibration
- 7** Procedure used Intercomparison Method
- 8** Identification of the calibrated item and serial number, if applicable
- 9** Name and address of the calibration laboratory
- 10** Nominal conventional mass
- 11** Conventional Mass As Found- mass that weighs at 20 °C in air of density of 1.2 milligram/cm³ against a standard density of 8.0 gram/cm³
- 12** Conventional mass correction of the weight before adjustment 2
- 13** Conventional Mass As Left - mass that weighs at 20 °C in air of density of 1.2 milligram/cm³ against a standard density of 8.0 gram/cm³
- 14** As left conventional mass correction of the weight²
- 15** A statement of the estimated value of uncertainty¹
- 16** Maximum permissible error for the specific accuracy class
- 17** Assumed density of the weight being calibrated
- 18** Environmental condition at time of calibration
- 19** Record of the weighing equipment
- 20** Reference standard set used to calibrate items listed on report

1 The Conventional Mass Correction is the deviation from the Nominal Value, reported in milligrams. A minus sign indicates that the weight is less than the nominal value.

2 All measurements have a degree of uncertainty regardless of precision and accuracy. This is caused by two factors, the limitation of the measuring instrument (systematic error) and the skill of the experimenter making the measurements (random error).

RICE LAKE
Certificate of Weight Calibration

Traceable Certificate Number: 1234567
Client: RICE LAKE WEIGHING SYSTEMS
Date Calibrated: 01 Jul 2020 to 02 Jul 2020

Temperature Range: 18 20.93°C to 21.00 °C
Pressure Range: 728.79 mmHg to 729.87 mmHg
Relative Humidity Range: 49 % to 52 %

As Left Data (As Found only shown when different than As Left)

10 Nominal Value	Unique ID	11 True Mass	12 True Mass Corr. (mg)	13 Conv. Mass	14 Conv. Mass Corr. (mg)	15 (k=2) Unc. (± mg)	16 MPE (± mg)	MPE Pass	17 Assumed Density (g/cm ³)	Assumed Material	Const. Type	19 Balance Used	20 Reference Standard Set Used	Air Density (mg/cm ³)	Clean Level
5 mg		4.99940	-0.00060	4.99939	-0.00061	0.00084	0.010	Y	7.95	SS	I	503Q	L595Q	1.1474	A
20 mg		20.00116	0.00116	20.00114	0.00114	0.00087	0.010	Y	7.95	SS	I	503Q	L595Q	1.1471	A
20 mg		20.00115	0.00115	20.00113	0.00112	0.00087	0.010	Y	7.95	SS	I	503Q	L595Q	1.1472	A
50 mg		50.0027	0.0027	50.0026	0.0026	0.0011	0.010	Y	7.95	SS	I	503Q	L595Q	1.1469	A
100 mg		99.9984	-0.0016	99.9983	-0.0017	0.0014	0.010	Y	7.95	SS	I	503Q	L595Q	1.1470	A
200 mg		199.9974	-0.0026	199.9972	-0.0028	0.0014	0.010	Y	7.95	SS	I	503Q	L595Q	1.1470	A
200 mg		199.9977	-0.0023	199.9975	-0.0025	0.0014	0.010	Y	7.95	SS	I	503Q	L595Q	1.1469	A
500 mg		499.9965	-0.0035	499.9960	-0.0040	0.0014	0.010	Y	7.95	SS	I	503Q	L595Q	1.1468	A
2 g		2.000016	0.0016	2.000027	0.0027	0.0023	0.034	Y	8.03	SS	II	650Q	L595Q	1.1470	A
2 g		2.000098	0.0098	2.000109	0.0109	0.0023	0.034	Y	8.03	SS	II	650Q	L595Q	1.1469	A
5 g		5.0000065	0.0065	5.0000093	0.0093	0.0046	0.034	Y	8.03	SS	II	650Q	L595Q	1.1469	A
10 g		9.9999517	-0.0483	9.9999573	-0.0427	0.0059	0.050	Y	8.03	SS	II	1958Q	L595Q	1.1480	A
20 g		19.9999780	-0.0220	19.9999892	-0.0108	0.0056	0.074	Y	8.03	SS	II	1958Q	L595Q	1.1479	A
20 g		19.9999828	-0.0172	19.9999940	-0.0060	0.0056	0.074	Y	8.03	SS	II	1958Q	L595Q	1.1478	A
50 g		49.999961	-0.039	49.999989	-0.011	0.011	0.12	Y	8.03	SS	II	1958Q	L595Q	1.1476	A
100 g		99.999817	-0.183	99.999873	-0.127	0.021	0.25	Y	8.03	SS	II	1958Q	L595Q	1.1478	A
200 g		199.999942	-0.058	200.000054	0.054	0.045	0.50	Y	8.03	SS	II	699Q	L595Q	1.1431	A
200 g		199.999862	-0.138	199.999974	-0.026	0.045	0.50	Y	8.03	SS	II	699Q	L595Q	1.1429	A

Page 2 of 2

Statement of Accuracy

A customer requesting a Statement of Accuracy needs proof that the nominal values represented by the mass in question have been designed and manufactured within exact specifications.

The Statement of Accuracy provides just such a document when and where traceability to NIST or an ISO/IEC 17025 accredited certificate of calibration is not a concern. The Statement of Accuracy is the least comprehensive documentation offered by Rice Lake Weighing Systems. Check your internal policies and procedures to determine what type of documentation you require and thoroughly review the Certificate of Weight Calibration, accredited and non-accredited, options prior to selecting laboratory documentation.

The Statement of Accuracy includes the following information:

- 1 Name and address of company that items are shipped to
- 2 Name and address of company that items were sold to
- 3 Part number
- 4 Description/Serial number
- 5 Maximum permissible error for the specific accuracy class
- 6 Name and address of the company that adjusted the weights

**Only applicable to new weights. Not a Legal for Trade or traceable document.*

Qty	Part Nbr	Description	Tolerance
1.0	12844 01	Weight, Heavy Cap 500lb NIST Class F Cast Iron Painted, Density 7.2	23 g

1 Ship To RICE LAKE WEIGHING SYSTEMS
 230 W COLEMAN ST
 RICE LAKE, WI 54868
 UNITED STATES OF AMERICA

2 Sold To RICE LAKE WEIGHING SYSTEMS
 230 W COLEMAN ST
 RICE LAKE, WI 54868
 UNITED STATES OF AMERICA

Dated 10-05-16
 Purchase Order Number RLWS
 Accuracy Report Number 2487012

THIS IS NOT A LEGAL-FOR-TRADE OR TRACEABLE DOCUMENT

Page 1 of 1

Weights listed above were compared to mass standards that are calibrated and traceable to the National Institute of Standards and Technology.
 Prepared By:
Rice Lake Weighing Systems
6 230 W. Coleman St. • Rice Lake, WI 54868 • USA
 TEL: 715-234-9171 • FAX: 715-234-6967 • www.ricelake.com
 An ISO 9001 registered company

This document shall not be reproduced, except in full, without the written approval of Rice Lake Weighing Systems' Metrology Laboratory.

PN 71065 6/15

Rice Lake Certificate Selection Guide

	Item on Certificate	Accredited Certificate of Weight Calibration	Non-Accredited Certificate of Weight Calibration	Statement of Accuracy
	ISO/IEC 17025 & ANSI/NCSL Z-540-1 Accredited Certificate	Yes	-	-
1	Name & Address of Calibration Laboratory	Yes	Yes	Yes
2	Contractor (Sold To) Name & Address*	Yes	Yes	Yes
3	Client (Ship To) Name & Address *	Yes	Yes	Yes
4	The Traceable Report Number of the Certificate for the Item under Calibration	Yes	Yes	-
5	Environmental Conditions at Time of Calibration	Yes	Yes	-
6	NIST Certificate of Calibration	Yes	Yes	-
7	Procedure Used	Yes	Yes	-
8	Identification of the Item(s) & Serial Number (If Applicable)	Yes	Yes	Yes
9	Nominal Conventional Mass	Yes	Yes	-
10	As Found Mass Value of Item under Calibration	Yes	Yes	-
11	As Left Mass Value of Item under Calibration	Yes	Yes	-
12	Estimated Uncertainty of the Measurement ¹	Yes	Yes	-
13	The Maximum Permissible Error for the Specified Accuracy Class	Yes	Yes	Yes
14	Equipment Number for the Mass Comparator/Balance Used to Perform the Calibration	Yes	Yes	-
15	The Reference Standards Used to Calibrate the Item under Test	Yes	Yes	-
16	Assumed Density of the Item(s)	Yes	Yes	Yes
17	Legal For Trade Document	Yes	-	-
18	True Mass Values	Available upon request	-	-
20	Disclaimers	May be required for weights that do not meet surface finish requirements	May be required for weights that do not meet surface finish requirements	-

* Can be specified by customer or client

¹ An expanded calibration uncertainty is required to establish metrological traceability.

Weight Class	Accredited to ISO/IEC 17025 & ANSI/NCSL Z540-1 Certificate of Weight Calibration	Non-Accredited Certificate of Weight Calibration	Non-Accredited & Not Traceable to NIST Statement of Accuracy
ASTM 00	Yes	-	-
ASTM 0	Yes	-	-
ASTM 1	Yes	Yes	Yes ²
ASTM 2	Yes	Yes	Yes ²
ASTM 3	Yes	Yes	Yes ²
ASTM 4	Yes	-	Yes ²
ASTM 5	Yes	-	Yes ²
ASTM 6	Yes	-	Yes ²
ASTM 7	Yes	-	Yes ²
OIML E1	Yes	-	-
OIML E2	Yes	-	-
OIML F1	Yes	Yes	Yes ²
OIML F2	Yes	Yes	Yes ²
OIML M1	Yes	-	Yes ²

Weight Class	Accredited to ISO/IEC 17025 & ANSI/NCSL Z540-1 Certificate of Weight Calibration	Non-Accredited Certificate of Weight Calibration	Non-Accredited & Not Traceable to NIST Statement of Accuracy
OIML M2	Yes	-	Yes ²
OIML M3	Yes	-	Yes ²
NIST F	Yes	-	Yes ²
NIST M	-	Yes	-
NIST S	Yes	Yes	-
NIST S-1	Yes	Yes	-
NIST P	Yes	Yes	-
NIST T	Yes	-	-
NIST C	Yes	-	-

² Only applicable to new weights

ASTM

Mass Reference Standards

Applications:

- Calibrating Class I and II balances
- Calibrating ASTM Class 4, 5 and 6 weights
- Student laboratory use
- Rough weighing operations; Force measuring operations
- Tolerance testing
- Verification checks

Designs Available:

- Type I design (one piece) for Class 0
- Type II design (two piece screw-knob) for Classes 1-4 with sealing cavity for adjusting material

Product Configuration:

- Single weight
- Single weight kit: includes weight, case or vial and glove
- Weight set: includes weights, case and handling equipment
- Weight set configurations: 5-2-2-1 and 5-3-2-1 Example: (1) 50 g, (2) 20 g and (1) 10 g or (1) 50 g, (1) 30 g, (1) 20 g and (1) 10 g

Custom Configuration:

- Custom sets are available as built-to-order configurations to meet your specific requirements
- ASTM weight sets larger than 500 g or 1lb include a hardwood case with velvet-lined pockets
- Weight sets with the largest weight of 500 g include a precision-machined, polyvinyl, crush-resistant case

Features:

- Stainless steel polished finish
- Designed to meet ASTM E617 specifications; ASTM Class 0 weight sets and individual weights are not individually marked with their weight value or individually serialized per ASTM E617
- Nominal value marked on weights
- Serial numbers applied to case (weights may be marked with symbol)
- Density 7.95 g/cm³





Metric Single Weight with Case (Kits)

18 Range: 25 kg – 1 mg

Metric Single Weights

19 Range: 25 kg – 1 mg

Metric Single Weight with Case (Kits)

20 Range: 50 kg – 1 g

Metric Single Weights

22 Range: 50 kg – 1 g

Metric Single Weight with Case (Kits)

24 Range: 500 mg – 0.5 mg

Metric Single Weights

25 Range: 500 mg – 1 mg

Avoirdupois Single Weight with Case (Kits)

26 Range: 30 lb – 1/16 oz

28 Range: 0.001 lb – 1/32 oz

Avoirdupois Single Weights

30 Range: 50 lb – 1/16 oz

32 Range: 0.001 lb – 1/32 oz

Avoirdupois Single Weight with Case (Kits)

33 Range: 50 lb – 1/16 oz

Avoirdupois Single Weights

34 Range: 0.001 lb – 1/32 oz

Sets

35 Essential Weights

Metric Sets

36 Range: 500 g

38 Range: 20 g

40 Range: 50 g

42 Range: 100 g

44 Range: 200 g

46 Range: 300 g and 500 g

48 Range: 1 kg

50 Range: 2 kg

52 Range: 3 kg and 5 kg

54 Range: 10 kg

56 Range: 20 kg and 25 kg

58 Range: 2 lb through 50 lb

59 Range: 2 lb through 50 lb

MASS REFERENCE STANDARDS / METRIC SINGLE WEIGHT WITH CASE (KITS)

RANGE: 25 kg – 1 mg

Class 0

Cylindrical

Statement of Accuracy is not available.

Class 0 enclosed in case per requirements.

Nominal Value	Kit Part #	Price	Certificate Accredited
25 kg	Consult	Consult	Included
20 kg	45856	\$4,450.00	Included
10 kg	45857	\$2,925.00	Included
5 kg	45858	\$2,100.00	Included
3 kg	45859	\$1,840.00	Included
2 kg	45860	\$1,520.00	Included
1 kg	45861	\$1,120.00	Included
500 g	45862	\$685.00	Included
300 g	45863	\$645.00	Included
200 g	45864	\$600.00	Included
100 g	45865	\$500.00	Included
50 g	45866	\$470.00	Included
30 g	45867	\$455.00	Included
20 g	45868	\$455.00	Included
10 g	45869	\$455.00	Included
5 g	45870	\$395.00	Included
3 g	45871	\$395.00	Included
2 g	45872	\$395.00	Included
1 g	45873	\$395.00	Included

Certificate**Accredited**

Kits Include a Single Weight with Case and Glove

Class 0

Leaf (Milligram)

Statement of Accuracy is not available.

Class 0 enclosed in vial per requirements.

Nominal Value	Kit Part #	Price	Certificate Accredited
500 mg	45874	\$305.00	Included
300 mg	45875	\$305.00	Included
200 mg	45876	\$305.00	Included
100 mg	45877	\$305.00	Included
50 mg	45878	\$305.00	Included
30 mg	45879	\$305.00	Included
20 mg	45880	\$305.00	Included
10 mg	45881	\$305.00	Included
5 mg	45882	\$305.00	Included
3 mg	45883	\$305.00	Included
2 mg	45884	\$305.00	Included
1 mg	45885	\$305.00	Included

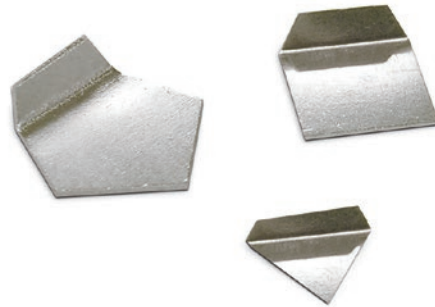
Certificate**Accredited****Replacement Cases**

Main Cases		
Class 0		
Nominal Value	Part #	Price
25 kg - 1 mg	Consult	Consult

Accessories

Description	Part #	Price
Tweezer	11711	\$5.00
Premium tweezer	152414	\$43.00
Weight glove, white cotton	11714	\$6.75
Leaf weight cover	11755	\$43.00
Lifter bar	11747	\$21.00
Lifter bar with larger handle	11712	\$73.00
Weight forceps	50035	\$43.00
Tong assembly	50000	\$74.00

RANGE: 25 kg – 1mg

Class 0

Cylindrical

Statement of Accuracy is not available.
Class 0 enclosed in case per requirements.

Nominal Value	Part #	Price
25 kg	Consult	Consult
20 kg	46097	\$4,375.00
10 kg	46096	\$2,850.00
5 kg	46095	\$2,030.00
3 kg	46094	\$1,820.00
2 kg	46093	\$1,490.00
1 kg	46092	\$1,100.00
500 g	46091	\$660.00
300 g	46090	\$625.00
200 g	46089	\$580.00
100 g	46088	\$485.00
50 g	46087	\$435.00
30 g	46086	\$435.00
20 g	46085	\$435.00
10 g	46084	\$435.00
5 g	46083	\$375.00
3 g	46082	\$375.00
2 g	46081	\$375.00
1g	46080	\$375.00

Certificate

Accredited
Included
Included
Included
Included
Included
Included
Included
Included
Included
Included
Included
Included
Included
Included
Included
Included
Included
Included
Included
Included
Included



Cylindrical Weight

Class 0

Leaf (Milligram)

Statement of Accuracy is not available, and weight requires a case for shipping.
For special kits, single weights must ship in a case.
Single leaf weights must ship in a vial.

Nominal Value	Part #	Price
500 mg	46079	\$300.00
300 mg	46078	\$300.00
200 mg	46077	\$300.00
100 mg	46076	\$300.00
50 mg	46075	\$300.00
30 mg	46074	\$300.00
20 mg	46073	\$300.00
10 mg	46072	\$300.00
5 mg	46071	\$300.00
3 mg	46070	\$300.00
2 mg	46069	\$300.00
1mg	46068	\$300.00

Certificate

Accredited
Included
Included
Included
Included
Included
Included
Included
Included
Included
Included
Included
Included
Included
Included
Included
Included

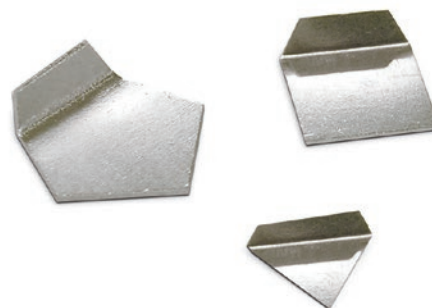

ASTM
PRECISION

OIML
PRECISION

BALANCE
CALIBRATION

STAINLESS
FIELD WEIGHTS

CAST IRON
FIELD WEIGHTS

ASTM
SPECIALTY

ACCESSORIES

Replacement Cases

Main Cases		
Class 0		
Nominal Value	Part #	Price
25 kg - 1mg	Consult	Consult

Accessories

Description	Part #	Price
Tweezer	11711	\$5.00
Premium tweezer	152414	\$43.00
Weight glove, white cotton	11714	\$6.75
Leaf weight cover	11755	\$43.00
Lifter bar	11747	\$21.00
Lifter bar with larger handle	11712	\$73.00
Weight forceps	50035	\$43.00
Tong assembly	50000	\$74.00

MASS REFERENCE STANDARDS / METRIC SINGLE WEIGHT WITH CASE (KITS)

RANGE: 50 kg – 1g

Class 1

Class 1 enclosed in vial/case per requirements.

Nominal Value	Kit Part #	Price
50 kg	Consult	Consult
25 kg	Consult	Consult
20 kg	82590	\$3,975.00
10 kg	82591	\$2,250.00
5 kg	82592	\$1,290.00
3 kg	82593	\$1,030.00
2 kg	82594	\$835.00
1 kg	82595	\$585.00
500 g	82596	\$250.00
300 g	82597	\$195.00
200 g	82598	\$185.00
100 g	82599	\$130.00
50 g	82600	\$125.00
30 g	82601	\$120.00
20 g	82602	\$115.00
10 g	82603	\$115.00
5 g	82604	\$115.00
3 g	82605	\$100.00
2 g	82606	\$100.00
1 g	82607	\$85.00

Optional Certificate

Accredited	Non-Accredited
Consult	Consult
Consult	Consult
\$145.00	\$80.00
\$145.00	\$80.00
\$145.00	\$80.00
\$145.00	\$80.00
\$145.00	\$80.00
\$125.00	\$60.00
\$125.00	\$60.00
\$125.00	\$60.00
\$125.00	\$60.00
\$55.00	\$45.00
\$55.00	\$45.00
\$55.00	\$45.00
\$55.00	\$45.00
\$55.00	\$45.00
\$55.00	\$45.00
\$55.00	\$45.00
\$55.00	\$45.00
\$55.00	\$45.00
\$55.00	\$45.00
\$55.00	\$45.00

Class 3

Class 3 enclosed in vial/case per requirements.

Weight	Kit Part #	Price
50 kg	Consult	Consult
25 kg	Consult	Consult
20 kg	82674	\$2,650.00
10 kg	82675	\$1,980.00
5 kg	82676	\$1,250.00
3 kg	82677	\$955.00
2 kg	82678	\$755.00
1 kg	82679	\$495.00
500 g	82680	\$235.00
300 g	82681	\$175.00
200 g	82682	\$165.00
100 g	82683	\$125.00
50 g	82684	\$115.00
30 g	82685	\$110.00
20 g	82686	\$100.00
10 g	82687	\$100.00
5 g	82688	\$73.00
3 g	82689	\$73.00
2 g	82690	\$73.00
1 g	82691	\$73.00

Optional Certificate

Accredited	Non-Accredited
Consult	Consult
Consult	Consult
\$145.00	\$80.00
\$145.00	\$80.00
\$145.00	\$80.00
\$145.00	\$80.00
\$145.00	\$80.00
\$125.00	\$60.00
\$125.00	\$60.00
\$125.00	\$60.00
\$125.00	\$60.00
\$125.00	\$60.00
\$55.00	\$45.00
\$55.00	\$45.00
\$55.00	\$45.00
\$55.00	\$45.00
\$55.00	\$45.00
\$55.00	\$45.00
\$55.00	\$45.00
\$55.00	\$45.00
\$55.00	\$45.00
\$55.00	\$45.00
\$55.00	\$45.00

Class 2

Class 2 enclosed in vial/case per requirements.

Nominal Value	Kit Part #	Price
50 kg	Consult	Consult
25 kg	Consult	Consult
20 kg	82632	\$2,675.00
10 kg	82633	\$2,160.00
5 kg	82634	\$1,250.00
3 kg	82635	\$985.00
2 kg	82636	\$770.00
1 kg	82637	\$505.00
500 g	82638	\$250.00
300 g	82639	\$185.00
200 g	82640	\$175.00
100 g	82641	\$130.00
50 g	82642	\$120.00
30 g	82643	\$110.00
20 g	82644	\$100.00
10 g	82645	\$100.00
5 g	82646	\$85.00
3 g	82647	\$85.00
2 g	82648	\$85.00
1 g	82649	\$85.00

Optional Certificate

Accredited	Non-Accredited
Consult	Consult
Consult	Consult
\$145.00	\$80.00
\$145.00	\$80.00
\$145.00	\$80.00
\$145.00	\$80.00
\$145.00	\$80.00
\$125.00	\$60.00
\$125.00	\$60.00
\$125.00	\$60.00
\$125.00	\$60.00
\$55.00	\$45.00
\$55.00	\$45.00
\$55.00	\$45.00
\$55.00	\$45.00
\$55.00	\$45.00
\$55.00	\$45.00
\$55.00	\$45.00
\$55.00	\$45.00
\$55.00	\$45.00
\$55.00	\$45.00
\$55.00	\$45.00

Kits Include a Single Weight
with Case and Glove

Replacement Cases

Main Cases		
Class 1, 2 and 3		
Nominal Value	Part #	Price
50 kg	Consult	Consult
25 kg	Consult	Consult
20 kg	80703	\$250.00
10 kg	80704	\$250.00
5 kg	80705	\$185.00
3 kg	190274	\$38.50
2 kg	190271	\$38.50
1 kg	190264	\$38.50
500 g	189715	\$38.50
300 g	196467	\$37.50

Main Cases		
Class 1, 2 and 3		
Nominal Value	Part #	Price
200 g	189637	\$38.50
100 g	189570	\$42.00
50 g	189509	\$42.00
30 g	189486	\$42.00
20 g	189484	\$42.00
10 g	189461	\$42.00
5 g	189349	\$42.00
3 g	194033	\$40.00
2 g	189237	\$42.00
1 g	198502	\$40.00

Accessories

Description	Part #	Price
Statement of Accuracy	36092	\$47.50
Serial number	25836	\$17.00
Tweezer	11711	\$5.00
Premium tweezer	152414	\$43.00
Weight glove, white cotton	11714	\$6.75
Leaf weight cover	11755	\$43.00
Lifter bar	11747	\$21.00
Lifter bar with larger handle	11712	\$73.00
Vial	50038	\$5.00

MASS REFERENCE STANDARDS / METRIC SINGLE WEIGHT WITH CASE (KITS)

RANGE: 50 kg – 1g

ASTM
PRECISION

OIML
PRECISION

BALANCE
CALIBRATION

STAINLESS
FIELD WEIGHTS

CAST IRON
FIELD WEIGHTS

ASTM
SPECIALTY

ACCESSORIES

Class 4

Nominal Value	Kit Part #	Price
50 kg	Consult	Consult
25 kg	Consult	Consult
20 kg	82716	\$2,450.00
10 kg	82717	\$1,780.00
5 kg	82718	\$1,230.00
3 kg	82719	\$890.00
2 kg	82720	\$725.00
1kg	82721	\$480.00
500 g	82722	\$230.00
300 g	82723	\$165.00
200 g	82724	\$140.00
100 g	82725	\$100.00
50 g	82726	\$100.00
30 g	82727	\$85.00
20 g	82728	\$85.00
10 g	82729	\$79.00
5 g	82730	\$62.00
3 g	82731	\$62.00
2 g	82732	\$62.00
1g	82733	\$62.00

Optional Certificate

Accredited
Consult
Consult
\$75.00
\$75.00
\$75.00
\$75.00
\$75.00
\$55.00
\$55.00
\$55.00
\$40.00
\$40.00
\$40.00
\$40.00
\$40.00
\$40.00
\$40.00
\$40.00
\$40.00
\$40.00



Kits include a Single Weight with Case and Glove

Replacement Cases

Main Cases		
Class 4		
Nominal Value	Part #	Price
50 kg	Consult	Consult
25 kg	Consult	Consult
20 kg	80703	\$250.00
10 kg	80704	\$250.00
5 kg	80705	\$185.00
3 kg	190274	\$38.50
2 kg	190271	\$38.50
1kg	190264	\$38.50
500 g	189715	\$38.50
300 g	196467	\$37.50
200 g	189637	\$38.50

Main Cases		
Class 4		
Nominal Value	Part #	Price
100 g	189570	\$42.00
50 g	189509	\$42.00
30 g	189486	\$42.00
20 g	189484	\$42.00
10 g	189461	\$42.00
5 g	189349	\$42.00
3 g	194033	\$40.00
2 g	189237	\$42.00
1g	198502	\$40.00

Accessories

Description	Part #	Price
Statement of Accuracy	36092	\$47.50
Serial number	25836	\$17.00
Tweezer	11711	\$5.00
Premium tweezer	152414	\$43.00
Weight glove, white cotton	11714	\$6.75
Leaf weight cover	11755	\$43.00
Lifter bar	11747	\$21.00
Lifter bar with larger handle	11712	\$73.00
Vial	50038	\$5.00

MASS REFERENCE STANDARDS / METRIC SINGLE WEIGHTS

RANGE: 50 kg – 1g

Class 1			Optional Certificate		Class 3			Optional Certificate	
Nominal Value	Part #	Price	Accredited	Non-Accredited	Nominal Value	Part #	Price	Accredited	Non-Accredited
50 kg	Consult	Consult	Consult	Consult	50 kg	12274	\$5,400.00	Consult	Consult
25 kg	11876	\$4,675.00	\$145.00	\$80.00	25 kg	12272	\$4,300.00	\$145.00	\$80.00
20 kg	11875	\$3,825.00	\$145.00	\$80.00	20 kg	12271	\$2,490.00	\$145.00	\$80.00
10 kg	11874	\$2,130.00	\$145.00	\$80.00	10 kg	12270	\$1,840.00	\$145.00	\$80.00
5 kg	11872	\$1,170.00	\$145.00	\$80.00	5 kg	12269	\$1,160.00	\$145.00	\$80.00
3 kg	11871	\$995.00	\$145.00	\$80.00	3 kg	12268	\$925.00	\$145.00	\$80.00
2 kg	11870	\$790.00	\$145.00	\$80.00	2 kg	12267	\$730.00	\$145.00	\$80.00
1 kg	11869	\$550.00	\$125.00	\$60.00	1 kg	12266	\$480.00	\$125.00	\$60.00
500 g	11867	\$230.00	\$125.00	\$60.00	500 g	12265	\$220.00	\$125.00	\$60.00
300 g	11866	\$175.00	\$125.00	\$60.00	300 g	12264	\$155.00	\$125.00	\$60.00
200 g	11865	\$160.00	\$125.00	\$60.00	200 g	12263	\$150.00	\$125.00	\$60.00
100 g	11864	\$120.00	\$55.00	\$45.00	100 g	12262	\$110.00	\$55.00	\$45.00
50 g	11862	\$115.00	\$55.00	\$45.00	50 g	12261	\$85.00	\$55.00	\$45.00
30 g	11861	\$105.00	\$55.00	\$45.00	30 g	12260	\$85.00	\$55.00	\$45.00
20 g	11860	\$105.00	\$55.00	\$45.00	20 g	12259	\$85.00	\$55.00	\$45.00
10 g	11859	\$100.00	\$55.00	\$45.00	10 g	12258	\$85.00	\$55.00	\$45.00
5 g	11857	\$93.00	\$55.00	\$45.00	5 g	12257	\$64.00	\$55.00	\$45.00
3 g	11856	\$79.00	\$55.00	\$45.00	3 g	12256	\$64.00	\$55.00	\$45.00
2 g	11855	\$79.00	\$55.00	\$45.00	2 g	12255	\$64.00	\$55.00	\$45.00
1 g	11854	\$73.00	\$55.00	\$45.00	1 g	12254	\$64.00	\$55.00	\$45.00

Class 2			Optional Certificate	
Nominal Value	Part #	Price	Accredited	Non-Accredited
50 kg	Consult	Consult	Consult	Consult
25 kg	12131	\$4,375.00	\$145.00	\$80.00
20 kg	12130	\$2,525.00	\$145.00	\$80.00
10 kg	12129	\$1,980.00	\$145.00	\$80.00
5 kg	12127	\$1,160.00	\$145.00	\$80.00
3 kg	12126	\$960.00	\$145.00	\$80.00
2 kg	12125	\$745.00	\$145.00	\$80.00
1 kg	12124	\$495.00	\$125.00	\$60.00
500 g	12122	\$225.00	\$125.00	\$60.00
300 g	12121	\$165.00	\$125.00	\$60.00
200 g	12120	\$155.00	\$125.00	\$60.00
100 g	12119	\$115.00	\$55.00	\$45.00
50 g	12117	\$93.00	\$55.00	\$45.00
30 g	12116	\$91.00	\$55.00	\$45.00
20 g	12115	\$91.00	\$55.00	\$45.00
10 g	12114	\$91.00	\$55.00	\$45.00
5 g	12112	\$68.00	\$55.00	\$45.00
3 g	12111	\$68.00	\$55.00	\$45.00
2 g	12110	\$68.00	\$55.00	\$45.00
1 g	12109	\$68.00	\$55.00	\$45.00

Replacement Cases

Main Cases		
Class 1, 2 and 3		
Nominal Value	Part #	Price
50 kg	Consult	Consult
25 kg	Consult	Consult
20 kg	80703	\$250.00
10 kg	80704	\$250.00
5 kg	80705	\$185.00
3 kg	190274	\$38.50
2 kg	190271	\$38.50
1 kg	190264	\$38.50
500 g	189715	\$38.50
300 g	196467	\$37.50

Main Cases		
Class 1, 2 and 3		
Nominal Value	Part #	Price
200 g	189637	\$38.50
100 g	189570	\$42.00
50 g	189509	\$42.00
30 g	189486	\$42.00
20 g	189484	\$42.00
10 g	189461	\$42.00
5 g	189349	\$42.00
3 g	194033	\$40.00
2 g	189237	\$38.00
1 g	198502	\$36.00

Accessories

Description	Part #	Price
Statement of Accuracy	36092	\$47.50
Serial number	25836	\$17.00
Tweezer	11711	\$5.00
Premium tweezer	152414	\$43.00
Weight glove, white cotton	11714	\$6.75
Leaf weight cover	11755	\$43.00
Lifter bar	11747	\$21.00
Lifter bar with larger handle	11712	\$73.00
Vial	50038	\$5.00

RANGE: 50 kg – 1g

Class 4

For special kits, single weights must ship in a case.

Nominal Value	Part #	Price
50 kg	Consult	Consult
25 kg	12375	\$4,225.00
20 kg	12374	\$2,330.00
10 kg	12373	\$1,640.00
5 kg	12372	\$1,100.00
3 kg	12371	\$860.00
2 kg	12370	\$700.00
1 kg	12369	\$455.00
500 g	12368	\$215.00
300 g	12367	\$150.00
200 g	12366	\$130.00
100 g	12365	\$93.00
50 g	12364	\$75.00
30 g	12363	\$68.00
20 g	12362	\$68.00
10 g	12361	\$68.00
5 g	12360	\$48.50
3 g	12359	\$48.50
2 g	12358	\$48.50
1 g	12357	\$48.50

Optional Certificate

Accredited
Consult
Consult
\$75.00
\$75.00
\$75.00
\$75.00
\$75.00
\$55.00
\$55.00
\$55.00
\$40.00
\$40.00
\$40.00
\$40.00
\$40.00
\$40.00
\$40.00
\$40.00
\$40.00
\$40.00
\$40.00



ASTM
PRECISION

OIML
PRECISION

BALANCE
CALIBRATION

STAINLESS
FIELD WEIGHTS

CAST IRON
FIELD WEIGHTS

ASTM
SPECIALTY

ACCESSORIES

Replacement Cases

Main Cases		
Class 4		
Nominal Value	Part #	Price
50 kg	Consult	Consult
25 kg	Consult	Consult
20 kg	80703	\$250.00
10 kg	80704	\$250.00
5 kg	80705	\$185.00
3 kg	190274	\$38.50
2 kg	190271	\$38.50
1 kg	190264	\$38.50
500 g	189715	\$38.50
300 g	196467	\$37.50

Main Cases		
Class 4		
Nominal Value	Part #	Price
200 g	189637	\$35.00
100 g	189570	\$38.00
50 g	189509	\$38.00
30 g	189486	\$38.00
20 g	189484	\$38.00
10 g	189461	\$38.00
5 g	189349	\$38.00
3 g	194033	\$36.00
2 g	189237	\$38.00
1 g	198502	\$36.00

Accessories

Description	Part #	Price
Statement of Accuracy	36092	\$47.50
Serial number	25836	\$17.00
Tweezer	11711	\$5.00
Premium tweezer	152414	\$43.00
Weight glove, white cotton	11714	\$6.75
Leaf weight cover	11755	\$43.00
Lifter bar	11747	\$21.00
Lifter bar with larger handle	11712	\$73.00
Vial	50038	\$5.00

MASS REFERENCE STANDARDS / METRIC SINGLE WEIGHTS

RANGE: 500 mg – 1 mg

Class 1

Single leaf weights must ship in a vial.

Nominal Value	Part #	Price
500 mg	11852	\$68.00
300 mg	11851	\$68.00
200 mg	11850	\$68.00
100 mg	11849	\$68.00
50 mg	11847	\$68.00
30 mg	11846	\$68.00
20 mg	11845	\$68.00
10 mg	11844	\$68.00
5 mg	11842	\$68.00
3 mg	11841	\$68.00
2 mg	11840	\$68.00
1 mg	11839	\$68.00

Optional Certificate

Accredited	Non-Accredited
\$55.00	\$45.00
\$55.00	\$45.00
\$55.00	\$45.00
\$55.00	\$45.00
\$55.00	\$45.00
\$55.00	\$45.00
\$55.00	\$45.00
\$55.00	\$45.00
\$55.00	\$45.00
\$55.00	\$45.00
\$55.00	\$45.00
\$55.00	\$45.00

Class 3

Single leaf weights must ship in a vial.

Nominal Value	Part #	Price
500 mg	12253	\$40.00
300 mg	12252	\$40.00
200 mg	12251	\$40.00
100 mg	12250	\$40.00
50 mg	12248	\$40.00
30 mg	12247	\$40.00
20 mg	12246	\$40.00
10 mg	12245	\$40.00
5 mg	12244	\$40.00
3 mg	12243	\$40.00
2 mg	12242	\$40.00
1 mg	12241	\$40.00

Optional Certificate

Accredited	Non-Accredited
\$55.00	\$45.00
\$55.00	\$45.00
\$55.00	\$45.00
\$55.00	\$45.00
\$55.00	\$45.00
\$55.00	\$45.00
\$55.00	\$45.00
\$55.00	\$45.00
\$55.00	\$45.00
\$55.00	\$45.00
\$55.00	\$45.00
\$55.00	\$45.00

Class 2

Single leaf weights must ship in a vial.

Nominal Value	Part #	Price
500 mg	12107	\$43.00
300 mg	12106	\$43.00
200 mg	12105	\$43.00
100 mg	12104	\$43.00
50 mg	12102	\$43.00
30 mg	12101	\$43.00
20 mg	12100	\$43.00
10 mg	12099	\$43.00
5 mg	12097	\$43.00
3 mg	12096	\$43.00
2 mg	12095	\$43.00
1 mg	12094	\$43.00

Optional Certificate

Accredited	Non-Accredited
\$55.00	\$45.00
\$55.00	\$45.00
\$55.00	\$45.00
\$55.00	\$45.00
\$55.00	\$45.00
\$55.00	\$45.00
\$55.00	\$45.00
\$55.00	\$45.00
\$55.00	\$45.00
\$55.00	\$45.00
\$55.00	\$45.00
\$55.00	\$45.00

Class 4

For special kits, single weights must ship in a case. Single leaf weights must ship in a vial.

Nominal Value	Part #	Price
500 mg	12356	\$37.50
300 mg	12355	\$37.50
200 mg	12354	\$37.50
100 mg	12353	\$37.50
50 mg	12352	\$37.50
30 mg	12351	\$37.50
20 mg	12350	\$37.50
10 mg	22198	\$37.50
5 mg	22197	\$37.50
3 mg	22196	\$37.50
2 mg	22195	\$37.50
1 mg	22194	\$37.50

Optional Certificate

Accredited
\$40.00
\$40.00
\$40.00
\$40.00
\$40.00
\$40.00
\$40.00
\$40.00
\$40.00
\$40.00
\$40.00
\$40.00



Leaf (Milligram) Weight

Replacement Cases

Main Cases		
Class 1, 2 and 3		
Nominal Value	Part #	Price
500 mg	Consult	Consult
300 mg	Consult	Consult
200 mg	Consult	Consult
100 mg	Consult	Consult
50 mg	Consult	Consult
30 mg	Consult	Consult

Main Cases		
Class 1, 2 and 3		
Nominal Value	Part #	Price
20 mg	Consult	Consult
10 mg	Consult	Consult
5 mg	Consult	Consult
3 mg	Consult	Consult
2 mg	Consult	Consult
1 mg	Consult	Consult

Accessories

Description	Part #	Price
Statement of Accuracy	36092	\$47.50
Serial number	25836	\$17.00
Tweezer	11711	\$5.00
Premium tweezer	152414	\$43.00
Weight glove, white cotton	11714	\$6.75
Leaf weight cover	11755	\$43.00
Lifter bar	11747	\$21.00
Lifter bar with larger handle	11712	\$73.00
Vial	50038	\$5.00

ASTM
PRECISION

OIML
PRECISION

BALANCE
CALIBRATION

STAINLESS
FIELD WEIGHTS

CAST IRON
FIELD WEIGHTS

ASTM
SPECIALTY

ACCESSORIES

MASS REFERENCE STANDARDS / AVOIRDUPOIS SINGLE WEIGHT WITH CASE (KITS)

RANGE: 30 lb – 1/16 oz

Class 1			Optional Certificate		Class 2			Optional Certificate	
Nominal Value	Kit Part #	Price	Accredited	Non-Accredited	Nominal Value	Kit Part #	Price	Accredited	Non-Accredited
30 lb	82581	\$4,125.00	\$130.00	\$85.00	30 lb	82625	\$4,025.00	\$130.00	\$85.00
25 lb	82580	\$2,850.00	\$130.00	\$85.00	25 lb	82624	\$3,425.00	\$130.00	\$85.00
20 lb	82579	\$2,825.00	\$130.00	\$85.00	20 lb	82623	\$2,750.00	\$130.00	\$85.00
10 lb	82578	\$1,660.00	\$130.00	\$85.00	10 lb	82622	\$1,620.00	\$130.00	\$85.00
5 lb	82589	\$1,200.00	\$130.00	\$85.00	5 lb	82631	\$1,150.00	\$130.00	\$85.00
4 lb	82588	\$1,010.00	\$130.00	\$85.00	4 lb	82630	\$965.00	\$130.00	\$85.00
3 lb	82587	\$765.00	\$130.00	\$85.00	3 lb	82629	\$700.00	\$130.00	\$85.00
2 lb	82586	\$670.00	\$105.00	\$70.00	2 lb	82628	\$630.00	\$105.00	\$70.00
1 lb	82585	\$340.00	\$105.00	\$70.00	1 lb	82627	\$320.00	\$105.00	\$70.00
8 oz	82584	\$280.00	\$55.00	\$45.00	8 oz	82626	\$265.00	\$55.00	\$45.00
0.5 lb	82570	\$285.00	\$55.00	\$45.00	0.5 lb	82614	\$265.00	\$55.00	\$45.00
0.3 lb	118809	\$215.00	\$55.00	\$45.00	0.3 lb	118810	\$205.00	\$55.00	\$45.00
0.2 lb	82569	\$185.00	\$55.00	\$45.00	0.2 lb	82613	\$185.00	\$55.00	\$45.00
0.1 lb	82568	\$135.00	\$55.00	\$45.00	0.1 lb	82612	\$125.00	\$55.00	\$45.00
0.05 lb	82567	\$125.00	\$55.00	\$45.00	0.05 lb	82611	\$120.00	\$55.00	\$45.00
0.03 lb	118805	\$120.00	\$55.00	\$45.00	0.03 lb	118806	\$110.00	\$55.00	\$45.00
0.02 lb	82566	\$120.00	\$55.00	\$45.00	0.02 lb	82610	\$115.00	\$55.00	\$45.00
0.01 lb	82565	\$120.00	\$55.00	\$45.00	0.01 lb	82609	\$110.00	\$55.00	\$45.00
0.005 lb	82564	\$120.00	\$55.00	\$45.00	0.005 lb	82608	\$110.00	\$55.00	\$45.00
0.003 lb	118801	\$120.00	\$55.00	\$45.00	0.003 lb	118802	\$110.00	\$55.00	\$45.00
4 oz	82577	\$155.00	\$55.00	\$45.00	4 oz	82621	\$155.00	\$55.00	\$45.00
2 oz	82576	\$135.00	\$55.00	\$45.00	2 oz	82620	\$125.00	\$55.00	\$45.00
1 oz	82575	\$115.00	\$55.00	\$45.00	1 oz	82619	\$115.00	\$55.00	\$45.00
1/2 oz	82574	\$110.00	\$55.00	\$45.00	1/2 oz	82618	\$105.00	\$55.00	\$45.00
1/4 oz	82573	\$110.00	\$55.00	\$45.00	1/4 oz	82617	\$105.00	\$55.00	\$45.00
1/8 oz	82572	\$110.00	\$55.00	\$45.00	1/8 oz	82616	\$105.00	\$55.00	\$45.00
1/16 oz	82571	\$110.00	\$55.00	\$45.00	1/16 oz	82615	\$105.00	\$55.00	\$45.00

Replacement Cases

Main Cases		
Class 1, 2 and 3 Screw Knob		
Nominal Value	Part #	Price
30 lb	80743	\$250.00
25 lb	80742	\$250.00
20 lb	80741	\$250.00
10 lb	80740	\$250.00
5 lb	190272	\$38.50
4 lb	190268	\$38.50
3 lb	190265	\$38.50
2 lb	190261	\$38.50
1 lb	189713	\$38.50
8 oz	189638	\$38.50
0.5 lb	189638	\$38.50
0.3 lb	189633	\$38.50
0.2 lb	189569	\$42.00
0.1 lb	189508	\$42.00

Main Cases		
Class 1, 2 and 3 Screw Knob		
Nominal Value	Part #	Price
0.05 lb	189485	\$42.00
0.03 lb	189478	\$42.00
0.02 lb	189460	\$42.00
0.01 lb	189349	\$42.00
0.005 lb	189239	\$42.00
0.003 lb	189234	\$42.00
4 oz	189571	\$42.00
2 oz	190126	\$38.50
1 oz	189486	\$42.00
1/2 oz	189478	\$42.00
1/4 oz	189350	\$42.00
1/8 oz	194034	\$40.00
1/16 oz	189237	\$42.00

Main Cases		
Class 4 Screw Knob		
Nominal Value	Part #	Price
30 lb	80743	\$250.00
25 lb	80742	\$250.00
20 lb	80741	\$250.00
10 lb	80740	\$250.00
5 lb	190272	\$38.50
4 lb	190268	\$38.50
3 lb	190265	\$38.50
2 lb	190261	\$38.50
1 lb	189713	\$38.50
8 oz	189638	\$38.50
0.5 lb	189638	\$38.50
0.3 lb	189633	\$38.50
0.2 lb	189569	\$42.00
0.1 lb	189508	\$42.00

MASS REFERENCE STANDARDS / AVOIRDUPOIS SINGLE WEIGHT WITH CASE (KITS)

RANGE: 30 lb – 1/16 oz

Class 3			Optional Certificate		Class 4			Optional Certificate	
Nominal Value	Kit Part #	Price	Accredited	Non-Accredited	Nominal Value	Kit Part #	Price	Accredited	
30 lb	82667	\$3,875.00	\$130.00	\$85.00	30 lb	82709	\$3,825.00	\$80.00	
25 lb	82666	\$3,275.00	\$130.00	\$85.00	25 lb	82708	\$3,250.00	\$80.00	
20 lb	82665	\$2,600.00	\$130.00	\$85.00	20 lb	82707	\$2,575.00	\$80.00	
10 lb	82664	\$1,510.00	\$130.00	\$85.00	10 lb	82706	\$1,500.00	\$80.00	
5 lb	82673	\$1,120.00	\$130.00	\$85.00	5 lb	82715	\$1,110.00	\$80.00	
4 lb	82672	\$930.00	\$130.00	\$85.00	4 lb	82714	\$845.00	\$80.00	
3 lb	82671	\$675.00	\$130.00	\$85.00	3 lb	82713	\$650.00	\$80.00	
2 lb	82670	\$610.00	\$105.00	\$70.00	2 lb	82712	\$590.00	\$65.00	
1 lb	82669	\$305.00	\$105.00	\$70.00	1 lb	82711	\$280.00	\$65.00	
8 oz	82668	\$265.00	\$55.00	\$45.00	8 oz	82710	\$255.00	\$40.00	
0.5 lb	82656	\$265.00	\$55.00	\$45.00	0.5 lb	82698	\$265.00	\$40.00	
0.3 lb	118811	\$170.00	\$55.00	\$45.00	0.3 lb	118812	\$185.00	\$40.00	
0.2 lb	82655	\$140.00	\$55.00	\$45.00	0.2 lb	82697	\$135.00	\$40.00	
0.1 lb	82654	\$125.00	\$55.00	\$45.00	0.1 lb	82696	\$115.00	\$40.00	
0.05 lb	82653	\$115.00	\$55.00	\$45.00	0.05 lb	82695	\$110.00	\$40.00	
0.03 lb	118807	\$110.00	\$55.00	\$45.00	0.03 lb	118808	\$93.00	\$40.00	
0.02 lb	82652	\$110.00	\$55.00	\$45.00	0.02 lb	82694	\$110.00	\$40.00	
0.01 lb	82651	\$110.00	\$55.00	\$45.00	0.01 lb	82693	\$110.00	\$40.00	
0.005 lb	82650	\$105.00	\$55.00	\$45.00	0.005 lb	82692	\$110.00	\$40.00	
0.003 lb	118803	\$105.00	\$55.00	\$45.00	0.003 lb	118804	\$110.00	\$40.00	
4 oz	82663	\$150.00	\$55.00	\$45.00	4 oz	82705	\$135.00	\$40.00	
2 oz	82662	\$125.00	\$55.00	\$45.00	2 oz	82704	\$125.00	\$40.00	
1 oz	82661	\$105.00	\$55.00	\$45.00	1 oz	82703	\$115.00	\$40.00	
1/2 oz	82660	\$105.00	\$55.00	\$45.00	1/2 oz	82702	\$110.00	\$40.00	
1/4 oz	82659	\$105.00	\$55.00	\$45.00	1/4 oz	82701	\$110.00	\$40.00	
1/8 oz	82658	\$105.00	\$55.00	\$45.00	1/8 oz	82700	\$110.00	\$40.00	
1/16 oz	82657	\$105.00	\$55.00	\$45.00	1/16 oz	82699	\$110.00	\$40.00	

ASTM PRECISION
OIML PRECISION
BALANCE CALIBRATION
STAINLESS FIELD WEIGHTS
CAST IRON FIELD WEIGHTS
ASTM SPECIALTY
ACCESSORIES



Kits include a single weight with case and glove

Accessories

Main Cases		
Class 4 Screw Knob		
Nominal Value	Part #	Price
0.05 lb	189485	\$42.00
0.03 lb	189478	\$42.00
0.02 lb	189460	\$42.00
0.01 lb	189349	\$42.00
0.005 lb	189239	\$42.00
0.003 lb	189234	\$42.00
4 oz	189571	\$42.00
2 oz	190126	\$38.50
1 oz	189486	\$42.00
1/2 oz	189478	\$42.00
1/4 oz	189350	\$42.00
1/8 oz	194034	\$40.00
1/16 oz	189237	\$42.00

Description	Part #	Price
Statement of Accuracy	36092	\$47.50
Weight glove, white cotton	11714	\$6.75
Tweezer	11711	\$5.00
Premium tweezer	152414	\$43.00
Serial number	25836	\$17.00
Vial	50038	\$5.00
Lifter bar	11747	\$21.00
Capsule	80420	\$5.00

MASS REFERENCE STANDARDS / AVOIRDUPOIS SINGLE WEIGHT WITH CASE (KITS)

RANGE: 0.001lb – 1/32 oz

Class 1

Enclosed in vial/case per requirements.

Optional Certificate

Nominal Value	Part #	Price	Optional Certificate	
			Accredited	Non-Accredited
0.001lb	80428	\$110.00	\$55.00	\$45.00
0.002lb	80439	\$110.00	\$55.00	\$45.00
1/32 oz	80442	\$110.00	\$55.00	\$45.00

Class 2

Enclosed in vial/case per requirements.

Optional Certificate

Nominal Value	Part #	Price	Optional Certificate	
			Accredited	Non-Accredited
0.001lb	80443	\$110.00	\$55.00	\$45.00
0.002lb	80445	\$105.00	\$55.00	\$45.00
1/32 oz	80446	\$105.00	\$55.00	\$45.00

Class 3

Enclosed in vial/case per requirements.

Optional Certificate

Nominal Value	Part #	Price	Optional Certificate	
			Accredited	Non-Accredited
0.001lb	80448	\$105.00	\$55.00	\$45.00
0.002lb	80449	\$105.00	\$55.00	\$45.00
1/32 oz	80451	\$105.00	\$55.00	\$45.00

**Replacement Cases**

Main Case		
Class 1, 2 and 3 Leaf		
Nominal Value	Part #	Price
0.001lb	Consult	Consult
0.002lb	Consult	Consult
1/32 oz	Consult	Consult

Accessories

Description	Part #	Price
Statement of Accuracy	36092	\$47.50
Weight glove, white cotton	11714	\$6.75
Tweezer	11711	\$5.00
Premium tweezer	152414	\$43.00
Serial number	25836	\$17.00
Vial	50038	\$5.00
Lifter bar	11747	\$21.00

MASS REFERENCE STANDARDS / AVOIRDUPOIS SINGLE WEIGHTS

RANGE: 50 lb – 1/16 oz

Class 1			Optional Certificate		Class 2			Optional Certificate	
Nominal Value	Part #	Price	Accredited	Non-Accredited	Weight	Part #	Price	Accredited	Non-Accredited
50 lb	12056	\$5,400.00	\$285.00	\$85.00	50 lb	12202	\$5,325.00	\$285.00	\$85.00
30 lb	12055	\$3,975.00	\$130.00	\$85.00	30 lb	12201	\$3,875.00	\$130.00	\$85.00
25 lb	12054	\$3,350.00	\$130.00	\$85.00	25 lb	12200	\$3,275.00	\$130.00	\$85.00
20 lb	12053	\$2,700.00	\$130.00	\$85.00	20 lb	12199	\$2,625.00	\$130.00	\$85.00
10 lb	12052	\$1,530.00	\$130.00	\$85.00	10 lb	12198	\$1,480.00	\$130.00	\$85.00
5 lb	12050	\$1,140.00	\$130.00	\$85.00	5 lb	12196	\$1,100.00	\$130.00	\$85.00
4 lb	12049	\$960.00	\$130.00	\$85.00	4 lb	12195	\$890.00	\$130.00	\$85.00
3 lb	12048	\$735.00	\$130.00	\$85.00	3 lb	12194	\$660.00	\$130.00	\$85.00
2 lb	12047	\$635.00	\$105.00	\$70.00	2 lb	12193	\$605.00	\$105.00	\$70.00
1 lb	12046	\$305.00	\$105.00	\$70.00	1 lb	12192	\$305.00	\$105.00	\$70.00
8 oz	12044	\$280.00	\$55.00	\$45.00	8 oz	12190	\$260.00	\$55.00	\$45.00
0.5 lb	12034	\$275.00	\$55.00	\$45.00	0.5 lb	12180	\$260.00	\$55.00	\$45.00
0.3 lb	118518	\$215.00	\$55.00	\$45.00	0.3 lb	118519	\$205.00	\$55.00	\$45.00
0.2 lb	12033	\$170.00	\$55.00	\$45.00	0.2 lb	12179	\$170.00	\$55.00	\$45.00
0.1 lb	12032	\$125.00	\$55.00	\$45.00	0.1 lb	12178	\$120.00	\$55.00	\$45.00
0.05 lb	12027	\$115.00	\$55.00	\$45.00	0.05 lb	12173	\$115.00	\$55.00	\$45.00
0.03 lb	118514	\$110.00	\$55.00	\$45.00	0.03 lb	118515	\$110.00	\$55.00	\$45.00
0.02 lb	12022	\$110.00	\$55.00	\$45.00	0.02 lb	12168	\$110.00	\$55.00	\$45.00
0.01 lb	12020	\$110.00	\$55.00	\$45.00	0.01 lb	12166	\$110.00	\$55.00	\$45.00
0.005 lb	12013	\$110.00	\$55.00	\$45.00	0.005 lb	12159	\$110.00	\$55.00	\$45.00
0.003 lb	118510	\$110.00	\$55.00	\$45.00	0.003 lb	118511	\$110.00	\$55.00	\$45.00
4 oz	12043	\$140.00	\$55.00	\$45.00	4 oz	12189	\$140.00	\$55.00	\$45.00
2 oz	12042	\$125.00	\$55.00	\$45.00	2 oz	12188	\$120.00	\$55.00	\$45.00
1 oz	12041	\$100.00	\$55.00	\$45.00	1 oz	12187	\$100.00	\$55.00	\$45.00
1/2 oz	12040	\$110.00	\$55.00	\$45.00	1/2 oz	12186	\$110.00	\$55.00	\$45.00
1/4 oz	12039	\$110.00	\$55.00	\$45.00	1/4 oz	12185	\$110.00	\$55.00	\$45.00
1/8 oz	12038	\$110.00	\$55.00	\$45.00	1/8 oz	12184	\$110.00	\$55.00	\$45.00
1/16 oz	12037	\$110.00	\$55.00	\$45.00	1/16 oz	12183	\$110.00	\$55.00	\$45.00

Replacement Cases

Main Cases		
Class 1, 2 and 3 Screw Knob		
Nominal Value	Part #	Price
50 lb	Consult	Consult
30 lb	80743	\$250.00
25 lb	80742	\$250.00
20 lb	80741	\$250.00
10 lb	80740	\$250.00
5 lb	190272	\$38.50
4 lb	190268	\$38.50
3 lb	190265	\$38.50
2 lb	190261	\$38.50
1 lb	189713	\$38.50

Main Cases		
Class 1, 2 and 3 Screw Knob		
Nominal Value	Part #	Price
8 oz	189638	\$38.50
0.5 lb	189638	\$38.50
0.3 lb	189633	\$38.50
0.2 lb	189569	\$42.00
0.1 lb	189508	\$42.00
0.05 lb	189485	\$42.00
0.03 lb	189478	\$42.00
0.02 lb	189460	\$42.00
0.01 lb	189349	\$42.00
0.005 lb	189239	\$42.00

Main Cases		
Class 1, 2 and 3 Screw Knob		
Nominal Value	Part #	Price
0.003 lb	189234	\$42.00
4 oz	189571	\$42.00
2 oz	190126	\$38.50
1 oz	189486	\$42.00
1/2 oz	189478	\$42.00
1/4 oz	189350	\$42.00
1/8 oz	194034	\$40.00
1/16 oz	189237	\$42.00

MASS REFERENCE STANDARDS / AVOIRDUPOIS SINGLE WEIGHTS

RANGE: 0.001lb – 1/32 oz

Class 1

Single leaf weights must ship in a vial.

Nominal Value	Part #	Price
0.001lb	12007	\$110.00
0.002lb	12009	\$110.00
1/32 oz	12036	\$110.00

Optional Certificate

Accredited	Non-Accredited
\$55.00	\$45.00
\$55.00	\$45.00
\$55.00	\$45.00

Class 2

Single leaf weights must ship in a vial.

Nominal Value	Part #	Price
0.001lb	12153	\$110.00
0.002lb	12155	\$110.00
1/32 oz	12182	\$110.00

Optional Certificate

Accredited	Non-Accredited
\$55.00	\$45.00
\$55.00	\$45.00
\$55.00	\$45.00

Class 3

Single leaf weights must ship in a vial.

Nominal Value	Part #	Price
0.001lb	12291	\$110.00
0.002lb	12293	\$110.00
1/32 oz	12317	\$110.00

Optional Certificate

Accredited	Non-Accredited
\$55.00	\$45.00
\$55.00	\$45.00
\$55.00	\$45.00

Class 4

For special kits-single weights must ship in a vial.

Nominal Value	Part #	Price
0.001lb	12394	\$93.00
0.002lb	12396	\$93.00
1/32 oz	12420	\$93.00

Optional Certificate

Accredited
\$40.00
\$40.00
\$40.00

**Replacement Cases**

Main Case		
Class 1, 2 and 3 Leaf		
Nominal Value	Part #	Price
0.001lb	Consult	Consult
0.002lb	Consult	Consult
1/32 oz	Consult	Consult

Main Case		
Class 4 Leaf		
Nominal Value	Part #	Price
0.001lb	Consult	Consult
0.002lb	Consult	Consult
1/32 oz	Consult	Consult

Accessories

Description	Part #	Price
Statement of Accuracy	36092	\$47.50
Weight glove, white cotton	11714	\$6.75
Tweezer	11711	\$5.00
Premium tweezer	152414	\$43.00
Serial number	25836	\$17.00
Vial	50038	\$5.00
Lifter bar	11747	\$21.00

MASS REFERENCE STANDARDS ESSENTIAL WEIGHTS

Class 0

Set Range	Part #	Price
2 g, 200 mg, 1 mg	186177	\$370.00
5 g, 500 mg, 1 mg	186178	\$400.00

Class 1

Set Range	Part #	Price
20 g, 2 g, 20 mg	186179	\$340.00
100 g, 10 g, 20 mg	186180	\$415.00
100 g, 10 g, 200 mg	186181	\$415.00
200 g, 20 g, 20 mg	186182	\$435.00
200 g, 20 g, 200 mg	186183	\$435.00
200 g, 20 g, 2 g	186184	\$455.00
500 g, 50 g, 200 mg	186185	\$580.00
500 g, 50 g, 2 g	186186	\$600.00
1 kg, 100 g, 2 g	186187	\$770.00
1 kg, 100 g, 20 g	186188	\$790.00
2 kg, 200 g, 2 g	186189	\$1,120.00
2 kg, 200 g, 20 g	186190	\$1,140.00
5 kg, 500 g, 2 g	186191	\$1,410.00
5 kg, 500 g, 20 g	186192	\$1,440.00
100 g, 10 g, 2 g	191089	\$455.00
500 g, 50 g, 20 mg	191091	\$655.00
50 g, 5 g, 200 mg	191092	\$445.00
50 g, 5 g, 2 g	191093	\$445.00

Standard Features

- Polished stainless steel Type II design
- Sealing cavity
- Density is approximately 7.95 g/cm³
- Special PVC weight case
- Precision tweezers included
- Configurations are ideal for calibration, shift tests and sensitivity tests
- Other configurations available by special order
- Meets USP-41 requirements for intermediate checks
- Includes ISO 17025 Accredited Certificate of Calibration



200g PVC Set Shown, Other Sets Will Vary

Accessories

Description	Part #	Price
Weight glove, white cotton	11714	\$6.75
Tweezer	11711	\$5.00
Premium tweezer	152414	\$43.00
Lifter bar	11747	\$21.00

ASTM
PRECISION

OIML
PRECISION

BALANCE
CALIBRATION

STAINLESS
FIELD WEIGHTS

CAST IRON
FIELD WEIGHTS

ASTM
SPECIALTY

ACCESSORIES

MASS REFERENCE STANDARDS / METRIC SETS

RANGE: 500 mg

Class 0

Statement of Accuracy not available.

Certificate

Set Range	Part #	Price	Accredited
500 mg - 1 mg	45933	\$2,140.00	Included
500 mg - 1 mg*	96359	\$2,140.00	Included
500 mg - 10 mg	84141	\$1,580.00	Included
500 mg - 10 mg*	98191	\$1,580.00	Included
500 mg - 100 mg	45934	\$1,100.00	Included
500 mg - 100 mg*	96360	\$1,100.00	Included

Class 1

Optional Certificate

Set Range	Part #	Price	Accredited	Non-accredited
500 mg - 1 mg	12445	\$660.00	\$470.00	\$375.00
500 mg - 1 mg*	11910	\$660.00	\$470.00	\$375.00
500 mg - 10 mg	12447	\$490.00	\$310.00	\$250.00
500 mg - 10 mg*	11909	\$490.00	\$310.00	\$250.00
500 mg - 100 mg	45952	\$455.00	\$155.00	\$125.00
500 mg - 100 mg*	45944	\$470.00	\$155.00	\$125.00

Class 2

Optional Certificate

Set Range	Part #	Price	Accredited	Non-accredited
500 mg - 1 mg	11838	\$570.00	\$470.00	\$375.00
500 mg - 1 mg*	12176	\$570.00	\$470.00	\$375.00
500 mg - 10 mg	11848	\$455.00	\$310.00	\$250.00
500 mg - 10 mg*	12175	\$455.00	\$310.00	\$250.00
500 mg - 100 mg	45953	\$400.00	\$155.00	\$125.00
500 mg - 100 mg*	45945	\$400.00	\$155.00	\$125.00

Class 3

Optional Certificate

Set Range	Part #	Price	Accredited	Non-accredited
500 mg - 1 mg	11946	\$550.00	\$470.00	\$375.00
500 mg - 1 mg*	12313	\$550.00	\$470.00	\$375.00
500 mg - 10 mg	11956	\$400.00	\$310.00	\$250.00
500 mg - 10 mg*	12312	\$400.00	\$310.00	\$250.00
500 mg - 100 mg	45954	\$320.00	\$155.00	\$125.00
500 mg - 100 mg*	45946	\$320.00	\$155.00	\$125.00

Class 4

Optional Certificate

Set Range	Part #	Price	Accredited
500 mg - 1 mg	12093	\$345.00	\$280.00
500 mg - 1 mg*	12416	\$345.00	\$280.00
500 mg - 10 mg	12103	\$260.00	\$190.00
500 mg - 10 mg*	12415	\$260.00	\$190.00
500 mg - 100 mg	45955	\$205.00	\$95.00
500 mg - 100 mg*	45947	\$205.00	\$95.00

* 5-2-2-1 configuration

Replacement Cases

Main Cases		
Class 0		
Set Range	Part #	Price
500 mg - 1 mg	34699	\$125.00
500 mg - 1 mg	34699	\$125.00
500 mg - 10 mg	34699	\$125.00
500 mg - 10 mg	34699	\$125.00
500 mg - 100 mg	34699	\$125.00
500 mg - 100 mg	34699	\$125.00

Main Case		
Class 1, 2 and 3 (Includes leaf weight lid and slot for tweezers)		
Set Range	Part #	Price
500 mg - 1 mg	11763	\$85.00
500 mg - 1 mg	11763	\$85.00
500 mg - 10 mg	11763	\$85.00
500 mg - 10 mg	11763	\$85.00
500 mg - 100 mg	11763	\$85.00
500 mg - 100 mg	11763	\$85.00

Main Cases		
Class 4		
Set Range	Part #	Price
500 mg - 1 mg	11763	\$85.00
500 mg - 1 mg	11763	\$85.00
500 mg - 10 mg	11763	\$85.00
500 mg - 10 mg	11763	\$85.00
500 mg - 100 mg	11763	\$85.00
500 mg - 100 mg	11763	\$85.00

RANGE: 500 mg

Weight Set Contents

5-2-2-1		5-2-2-1		5-2-2-1	
500 mg - 1 mg	500 mg - 1 mg	500 mg - 10 mg	500 mg - 10 mg	500 mg - 100 mg	500 mg - 100 mg
45933 Class 0	96359 Class 0	84141 Class 0	98191 Class 0	45934 Class 0	96360 Class 0
12445 Class 1	11910 Class 1	12447 Class 1	11909 Class 1	45952 Class 1	45944 Class 1
11838 Class 2	12176 Class 2	11848 Class 2	12175 Class 2	45953 Class 2	45945 Class 2
11946 Class 3	12313 Class 3	11956 Class 3	12312 Class 3	45954 Class 3	45946 Class 3
12093 Class 4	12416 Class 4	12103 Class 4	12415 Class 4	45955 Class 4	45947 Class 4
(1) 500 mg	(1) 500 mg	(1) 500 mg	(1) 500 mg	(1) 500 mg	(1) 500 mg
(1) 300 mg	–	(1) 300 mg	–	(1) 300 mg	–
(1) 200 mg	(2) 200 mg	(1) 200 mg	(2) 200 mg	(1) 200 mg	(2) 200 mg
(1) 100 mg	(1)	(1) 100 mg	(1) 100 mg	(1) 100 mg	(1) 100 mg
(1) 50 mg	(1) 50 mg	(1) 50 mg	(1) 50 mg		
(1) 30 mg	–	(1) 30 mg	–		
(1) 20 mg	(2) 20 mg	(1) 20 mg	(2) 20 mg		
(1) 10 mg	(1) 10 mg	(1) 10 mg	(1) 10 mg		
(1) 5 mg	(1) 5 mg				
(1) 3 mg	(2) 2 mg				
(1) 2 mg	–				
(1) 1 mg	(1) 1 mg				
12 pcs. 1.221g set wt.	12 pcs. 1.11g set wt.	8 pcs. 1.21g set wt.	8 pcs. 1.11g set wt.	4 pcs. 1.1g set wt.	4 pcs. 0.8g set wt.



PN 12093 Set Includes Tweezer and Glove

Accessories

Description	Part #	Price
Statement of Accuracy	36092	\$47.50
Weight glove, white cotton	11714	\$6.75
Tweezer	11711	\$5.00
Premium tweezer	152414	\$43.00
Serial number	25836	\$17.00

ASTM
PRECISION

OIML
PRECISION

BALANCE
CALIBRATION

STAINLESS
FIELD WEIGHTS

CAST IRON
FIELD WEIGHTS

ASTM
SPECIALTY

ACCESSORIES

MASS REFERENCE STANDARDS / METRIC SETS

RANGE: 20 g

Class 0*(Statement of Accuracy not available)*

Set Range	Part #	Price
20 g - 1 mg	84154	\$2,925.00
20 g - 5 mg	84149	\$3,125.00
20 g - 10 mg	84148	\$2,900.00
20 g - 100 mg	84146	\$2,180.00
20 g - 1 g	84155	\$1,580.00

Certificate

Accredited
Included
Included
Included
Included
Included

Class 1

Set Range	Part #	Price
20 g - 1 mg	12448	\$1,140.00
20 g - 1 mg*	11908	\$1,140.00
20 g - 5 mg	12450	\$980.00
20 g - 5 mg*	11907	\$980.00
20 g - 10 mg	12451	\$940.00
20 g - 10 mg*	11906	\$940.00
20 g - 100 mg	84145	\$795.00
20 g - 100 mg*	11905	\$795.00
20 g - 1 g	12452	\$660.00
20 g - 1 g*	11904	\$660.00

Optional Certificate

Accredited	Non-accredited
\$705.00	\$560.00
\$705.00	\$560.00
\$595.00	\$470.00
\$595.00	\$470.00
\$545.00	\$440.00
\$545.00	\$440.00
\$390.00	\$310.00
\$390.00	\$310.00
\$235.00	\$190.00
\$235.00	\$190.00

Class 2

Set Range	Part #	Price
20 g - 1 mg	11853	\$950.00
20 g - 1 mg*	12174	\$950.00
20 g - 5 mg	11858	\$840.00
20 g - 5 mg*	12172	\$840.00
20 g - 10 mg	11863	\$770.00
20 g - 10 mg*	12171	\$770.00
20 g - 100 mg	84144	\$670.00
20 g - 100 mg*	12170	\$670.00
20 g - 1 g	11868	\$570.00
20 g - 1 g*	12169	\$570.00

Optional Certificate

Accredited	Non-accredited
\$705.00	\$560.00
\$705.00	\$560.00
\$595.00	\$470.00
\$595.00	\$470.00
\$545.00	\$440.00
\$545.00	\$440.00
\$390.00	\$310.00
\$390.00	\$310.00
\$235.00	\$190.00
\$235.00	\$190.00

Class 3

Set Range	Part #	Price
20 g - 1 mg	11961	\$860.00
20 g - 1 mg*	12311	\$860.00
20 g - 5 mg	11966	\$775.00
20 g - 5 mg*	12309	\$775.00
20 g - 10 mg	11971	\$700.00
20 g - 10 mg*	22188	\$700.00
20 g - 100 mg	84143	\$625.00
20 g - 100 mg*	22187	\$625.00
20 g - 1 g	11976	\$495.00
20 g - 1 g*	22186	\$495.00

Optional Certificate

Accredited	Non-accredited
\$705.00	\$560.00
\$705.00	\$560.00
\$595.00	\$470.00
\$595.00	\$470.00
\$545.00	\$440.00
\$545.00	\$440.00
\$390.00	\$310.00
\$390.00	\$310.00
\$235.00	\$190.00
\$235.00	\$190.00

Class 4

Set Range	Part #	Price
20 g - 1 mg	12108	\$650.00
20 g - 1 mg*	12414	\$650.00
20 g - 5 mg	12113	\$605.00
20 g - 5 mg*	12412	\$605.00
20 g - 10 mg	12118	\$580.00
20 g - 10 mg*	12411	\$580.00
20 g - 100 mg	84142	\$485.00
20 g - 100 mg*	12410	\$485.00
20 g - 1 g	12123	\$395.00
20 g - 1 g*	12409	\$395.00

Optional Certificate

Accredited
\$430.00
\$430.00
\$355.00
\$355.00
\$325.00
\$325.00
\$235.00
\$235.00
\$140.00
\$140.00

* 5-2-2-1 configuration



PN 12108 Set Includes Lifting Device, Glove and Case

RANGE: 20 g

ASTM
PRECISION

Weight Set Contents

5-2-2-1		5-2-2-1		5-2-2-1		5-2-2-1		5-2-2-1	
20g - 1mg	20g - 1mg	20g - 5mg	20g - 5mg	20g - 10mg	20g - 10mg	20g - 100mg	20g - 100mg	20g - 1g	20g - 1g
84154 Class 0	–	84149 Class 0	–	84148 Class 0	–	84146 Class 0	–	84155 Class 0	–
12448 Class 1	11908 Class 1	12450 Class 1	11907 Class 1	12451 Class 1	11906 Class 1	84145 Class 1	11905 Class 1	12452 Class 1	11904 Class 1
11853 Class 2	12174 Class 2	11858 Class 2	12172 Class 2	11863 Class 2	12171 Class 2	84144 Class 2	12170 Class 2	11868 Class 2	12169 Class 2
11961 Class 3	12311 Class 3	11966 Class 3	12309 Class 3	11971 Class 3	22188 Class 3	84143 Class 3	22187 Class 3	11976 Class 3	22186 Class 3
12108 Class 4	12414 Class 4	12113 Class 4	12412 Class 4	12118 Class 4	12411 Class 4	84142 Class 4	12410 Class 4	12123 Class 4	12409 Class 4
(1) 20 g	(1) 20 g	(1) 20 g	(1) 20 g	(1) 20 g	(1) 20 g	(1) 20 g	(1) 20 g	(1) 20 g	(1) 20 g
(1) 10 g	(1) 10 g	(1) 10 g	(1) 10 g	(1) 10 g	(1) 10 g	(1) 10 g	(1) 10 g	(1) 10 g	(1) 10 g
(1) 5 g	(1) 5 g	(1) 5 g	(1) 5 g	(1) 5 g	(1) 5 g	(1) 5 g	(1) 5 g	(1) 5 g	(1) 5 g
(1) 3 g	–	(1) 3 g	–	(1) 3 g	–	(1) 3 g	–	(1) 3 g	–
(1) 2 g	(2) 2 g	(1) 2 g	(2) 2 g	(1) 2 g	(1) 2 g	(1) 2 g	(2) 2 g	(1) 2 g	(2) 2 g
(1) 1 g	(1) 1 g	(1) 1 g	(1) 1 g	(1) 1 g	(1) 1 g	(1) 1 g	(1) 1 g	(1) 1 g	(1) 1 g
(1) 500 mg	(1) 500 mg	(1) 500 mg	(1) 500 mg	(1) 500 mg	(1) 500 mg	(1) 500 mg	(1) 500 mg	(1) 500 mg	
(1) 300 mg	–	(1) 300 mg	–	(1) 300 mg	–	(1) 300 mg	–	–	
(1) 200 mg	(2) 200 mg	(1) 200 mg	(2) 200 mg	(1) 200 mg	(2) 200 mg	(1) 200 mg	(2) 200 mg		
(1) 100 mg	(1) 100 mg	(1) 100 mg	(1) 100 mg	(1) 100 mg	(1) 100 mg	(1) 100 mg	(1) 100 mg		
(1) 50 mg	(1) 50 mg	(1) 50 mg	(1) 50 mg	(1) 50 mg	(1) 50 mg				
(1) 30 mg	–	(1) 30 mg	–	(1) 30 mg	–				
(1) 20 mg	(2) 20 mg	(1) 20 mg	(2) 20 mg	(1) 20 mg	(2) 20 mg				
(1) 10 mg	(1) 10 mg	(1) 10 mg	(1) 10 mg	(1) 10 mg	(1) 10 mg				
(1) 5 mg	(1) 5 mg	(1) 5 mg	(1) 5 mg						
(1) 3 mg	–								
(1) 2 mg	(2) 2 mg								
(1) 1 mg	(1) 1 mg								
18 pcs. 42.221g set wt.	18 pcs. 42.221g set wt.	15 pcs. 42.215g set wt.	15 pcs. 42.215g set wt.	14 pcs. 42.421g set wt.	14 pcs. 41.1g set wt.	10 pcs. 41g set wt.	10 pcs. 41g set wt.	6 pcs. 41g set wt.	6 pcs. 40g set wt.

OIML
PRECISION

BALANCE
CALIBRATION

STAINLESS
FIELD WEIGHTS

CAST IRON
FIELD WEIGHTS

ASTM
SPECIALTY

ACCESSORIES

Replacement Cases

Main Cases		
Class 0		
Set Range	Part #	Price
20 g - 1mg	49503	\$250.00
20 g - 5 mg	49503	\$250.00
20 g - 10 mg	49503	\$250.00
20 g - 100 mg	49503	\$250.00
20 g - 1g	49503	\$250.00

Main Case		
Class 1, 2 and 3		
Set Range	Part #	Price
20 g - 1mg	11596	\$180.00
20 g - 1mg	11588	\$180.00
20 g - 5 mg	11596	\$180.00
20 g - 5 mg	11588	\$180.00
20 g - 10 mg	11596	\$180.00
20 g - 10 mg	11588	\$180.00
20 g - 100 mg	11596	\$180.00
20 g - 100 mg	11588	\$180.00
20 g - 1g	11596	\$180.00
20 g - 1g	11588	\$180.00

Main Cases		
Class 4		
Set Range	Part #	Price
20 g - 1mg	11596	\$180.00
20 g - 1mg	11588	\$180.00
20 g - 5 mg	11596	\$180.00
20 g - 5 mg	11588	\$180.00
20 g - 10 mg	11596	\$180.00
20 g - 10 mg	11588	\$180.00
20 g - 100 mg	11596	\$180.00
20 g - 100 mg	11588	\$180.00
20 g - 1g	11596	\$180.00
20 g - 1g	11588	\$180.00

Accessories

Description	Part #	Price
Statement of Accuracy	36092	\$47.50
Weight glove, white cotton	11714	\$6.75
Tweezer	11711	\$5.00
Premium tweezer	152414	\$43.00
Serial number	25836	\$17.00
Leaf weight cover	11755	\$43.00

MASS REFERENCE STANDARDS / METRIC SETS

RANGE: 50 g

Class 0

Statement of Accuracy not available.

Set Range	Part #	Price
50 g - 1 mg	84177	\$3,775.00
50 g - 5 mg	84176	\$3,525.00
50 g - 10 mg	84164	\$3,200.00
50 g - 100 mg	84163	\$2,420.00
50 g - 1 g	84178	\$1,890.00

Certificate

Accredited
Included
Included
Included
Included
Included

Class 1

Set Range	Part #	Price
50 g - 1 mg	12453	\$1,120.00
50 g - 1 mg*	11903	\$1,120.00
50 g - 5 mg	12454	\$1,040.00
50 g - 5 mg*	11902	\$1,040.00
50 g - 10 mg	12455	\$985.00
50 g - 10 mg*	11900	\$985.00
50 g - 100 mg	84159	\$855.00
50 g - 100 mg*	11899	\$855.00
50 g - 1 g	12456	\$710.00
50 g - 1 g*	11898	\$725.00

Optional Certificate

Accredited	Non-accredited
\$790.00	\$630.00
\$790.00	\$630.00
\$670.00	\$530.00
\$670.00	\$530.00
\$630.00	\$500.00
\$630.00	\$500.00
\$470.00	\$375.00
\$470.00	\$375.00
\$310.00	\$250.00
\$310.00	\$250.00

Class 2

Set Range	Part #	Price
50 g - 1 mg	11873	\$985.00
50 g - 1 mg*	12167	\$985.00
50 g - 5 mg	11879	\$900.00
50 g - 5 mg*	12165	\$900.00
50 g - 10 mg	11880	\$855.00
50 g - 10 mg*	12163	\$855.00
50 g - 100 mg	84160	\$685.00
50 g - 100 mg*	12162	\$685.00
50 g - 1 g	11890	\$615.00
50 g - 1 g*	12161	\$615.00

Optional Certificate

Accredited	Non-accredited
\$790.00	\$630.00
\$790.00	\$630.00
\$670.00	\$530.00
\$670.00	\$530.00
\$630.00	\$500.00
\$630.00	\$500.00
\$470.00	\$375.00
\$470.00	\$375.00
\$310.00	\$250.00
\$310.00	\$250.00

Class 3

Set Range	Part #	Price
50 g - 1 mg	11982	\$925.00
50 g - 1 mg*	22288	\$925.00
50 g - 5 mg	11988	\$815.00
50 g - 5 mg*	22182	\$815.00
50 g - 10 mg	11989	\$785.00
50 g - 10 mg*	22181	\$785.00
50 g - 100 mg	84161	\$650.00
50 g - 100 mg*	12300	\$650.00
50 g - 1 g	12004	\$565.00
50 g - 1 g*	12299	\$565.00

Optional Certificate

Accredited	Non-accredited
\$790.00	\$630.00
\$790.00	\$630.00
\$670.00	\$530.00
\$670.00	\$530.00
\$630.00	\$500.00
\$630.00	\$500.00
\$470.00	\$375.00
\$470.00	\$375.00
\$310.00	\$250.00
\$310.00	\$250.00

Class 4

Set Range	Part #	Price
50 g - 1 mg	12128	\$785.00
50 g - 1 mg*	12407	\$785.00
50 g - 5 mg	12134	\$715.00
50 g - 5 mg*	12405	\$715.00
50 g - 10 mg	12135	\$690.00
50 g - 10 mg*	12404	\$690.00
50 g - 100 mg	84162	\$590.00
50 g - 100 mg*	12403	\$590.00
50 g - 1 g	12150	\$495.00
50 g - 1 g*	12402	\$495.00

Optional Certificate

Accredited
\$475.00
\$475.00
\$400.00
\$400.00
\$380.00
\$380.00
\$280.00
\$280.00
\$190.00
\$190.00

* 5-2-2-1 configuration



PN 12453 Set Includes Lifting Device, Glove and Case

RANGE: 50 g

Weight Set Contents

5-2-2-1		5-2-2-1		5-2-2-1		5-2-2-1		5-2-2-1	
50 g - 1mg	50 g - 1mg	50 g - 5mg	50 g - 5mg	50 g - 10mg	50 g - 10mg	50 g - 100mg	50 g - 100mg	50 g - 1g	50 g - 1g
84177 Class 0	–	84176 Class 0	–	84164 Class 0	–	84163 Class 0	–	84178 Class 0	–
12453 Class 1	11903 Class 1	12454 Class 1	11902 Class 1	12455 Class 1	11900 Class 1	84159 Class 1	11899 Class 1	12456 Class 1	11898 Class 1
11873 Class 2	12167 Class 2	11879 Class 2	12165 Class 2	11880 Class 2	12163 Class 2	84160 Class 2	12162 Class 2	11890 Class 2	12161 Class 2
11982 Class 3	22288 Class 3	11988 Class 3	22182 Class 3	11989 Class 3	22181 Class 3	84161 Class 3	12300 Class 3	12004 Class 3	12299 Class 3
12128 Class 4	12407 Class 4	12134 Class 4	12405 Class 4	12135 Class 4	12404 Class 4	84162 Class 4	12403 Class 4	12150 Class 4	12402 Class 4
(1) 50 g	(1) 50 g	(1) 50 g	(1) 50 g	(1) 50 g	(1) 50 g	(1) 50 g	(1) 50 g	(1) 50 g	(1) 50 g
(1) 30 g	–	(1) 30 g	–	(1) 30 g	–	(1) 30 g	–	(1) 30 g	–
(1) 20 g	(2) 20 g	(1) 20 g	(2) 20 g	(1) 20 g	(2) 20 g	(1) 20 g	(2) 20 g	(1) 20 g	(2) 20 g
(1) 10 g	(1) 10 g	(1) 10 g	(1) 10 g	(1) 10 g	(1) 10 g	(1) 10 g	(1) 10 g	(1) 10 g	(1) 10 g
(1) 5 g	(1) 5 g	(1) 5 g	(1) 5 g	(1) 5 g	(1) 5 g	(1) 5 g	(1) 5 g	(1) 5 g	(1) 5 g
(1) 3 g	–	(1) 3 g	–	(1) 3 g	–	(1) 3 g	–	(1) 3 g	–
(1) 2 g	(2) 2 g	(1) 2 g	(2) 2 g	(1) 2 g	(2) 2 g	(1) 2 g	(2) 2 g	(1) 2 g	(2) 2 g
(1) 1 g	(1) 1 g	(1) 1 g	(1) 1 g	(1) 1 g	(1) 1 g	(1) 1 g	(1) 1 g	(1) 1 g	(1) 1 g
(1) 500 mg	(1) 500 mg	(1) 500 mg	(1) 500 mg	(1) 500 mg	(1) 500 mg	(1) 500 mg	(1) 500 mg		
(1) 300 mg	–	(1) 300 mg	–	(1) 300 mg	–	(1) 300 mg	–		
(1) 200 mg	(2) 200 mg	(1) 200 mg	(2) 200 mg	(1) 200 mg	(2) 200 mg	(1) 200 mg	(2) 200 mg		
(1) 100 mg	(1) 100 mg	(1) 100 mg	(1) 100 mg	(1) 100 mg	(1) 100 mg	(1) 100 mg	(1) 100 mg		
(1) 50 mg	(1) 50 mg	(1) 50 mg	(1) 50 mg	(1) 50 mg	(1) 50 mg				
(1) 30 mg	–	(1) 30 mg	–	(1) 30 mg	–				
(1) 20 mg	(2) 20 mg	(1) 20 mg	(2) 20 mg	(1) 20 mg	(2) 20 mg				
(1) 10 mg	(1) 10 mg	(1) 10 mg	(1) 10 mg	(1) 10 mg	(1) 10 mg				
(1) 5 mg	(1) 5 mg	(1) 5 mg	(1) 5 mg						
(1) 3 mg	(2) 2 mg								
(1) 2 mg	(1) 1 mg								
(1) 1 mg									
20 pcs. 122.221g set wt.	20 pcs. 111.11g set wt.	17 pcs. 122.215g set wt.	17 pcs. 111.105g set wt.	16 pcs. 122.21g set wt.	16 pcs. 111.11g set wt.	12 pcs. 122.1g set wt.	12 pcs. 111g set wt.	8 pcs. 121g set wt.	8 pcs. 110g set wt.

ASTM
PRECISION

OIML
PRECISION

BALANCE
CALIBRATION

STAINLESS
FIELD WEIGHTS

CAST IRON
FIELD WEIGHTS

ASTM
SPECIALTY

ACCESSORIES

Replacement Cases

Main Cases		
Class 0		
Set Range	Part #	Price
50 g - 1mg	49503	\$250.00
50 g - 5mg	49503	\$250.00
50 g - 10mg	49503	\$250.00
50 g - 100mg	49503	\$250.00
50 g - 1g	49503	\$250.00

Main Case		
Class 1, 2 and 3		
Set Range	Part #	Price
50 g - 1mg	11596	\$180.00
50 g - 1mg	11588	\$180.00
50 g - 5mg	11596	\$180.00
50 g - 5mg	11588	\$180.00
50 g - 10mg	11596	\$180.00
50 g - 10mg	11588	\$180.00
50 g - 100mg	11596	\$180.00
50 g - 100mg	11588	\$180.00
50 g - 1g	11596	\$180.00
50 g - 1g	11588	\$180.00

Main Cases		
Class 4		
Set Range	Part #	Price
50 g - 1mg	11596	\$180.00
50 g - 1mg	11588	\$180.00
50 g - 5mg	11596	\$180.00
50 g - 5mg	11588	\$180.00
50 g - 10mg	11596	\$180.00
50 g - 10mg	11588	\$180.00
50 g - 100mg	11596	\$180.00
50 g - 100mg	11588	\$180.00
50 g - 1g	11596	\$180.00
50 g - 1g	11588	\$180.00

Accessories

Description	Part #	Price
Statement of Accuracy	36092	\$47.50
Weight glove, white cotton	11714	\$6.75
Tweezer	11711	\$5.00
Premium tweezer	152414	\$43.00
Serial number	25836	\$17.00
Leaf weight cover	11755	\$43.00

MASS REFERENCE STANDARDS / METRIC SETS

RANGE: 100 g

Class 0

Statement of Accuracy not available

Set Range	Part #	Price
100 g - 1 mg	45930	\$4,150.00
100 g - 5 mg	84211	\$3,625.00
100 g - 10 mg	84212	\$3,350.00
100 g - 100 mg	45931	\$2,775.00
100 g - 1 g	45932	\$2,010.00

Certificate

Accredited
Included
Included
Included
Included
Included

Class 1

Set Range	Part #	Price
100 g - 1 mg	12457	\$1,210.00
100 g - 1 mg*	11897	\$1,210.00
100 g - 5 mg	11911	\$1,080.00
100 g - 5 mg*	11896	\$1,080.00
100 g - 10 mg	12460	\$1,060.00
100 g - 10 mg*	11895	\$1,060.00
100 g - 100 mg	45956	\$860.00
100 g - 100 mg*	45948	\$860.00
100 g - 1 g	12461	\$775.00
100 g - 1 g*	11894	\$775.00

Optional Certificate

Accredited	Non-accredited
\$830.00	\$620.00
\$830.00	\$620.00
\$705.00	\$540.00
\$705.00	\$540.00
\$670.00	\$530.00
\$670.00	\$530.00
\$510.00	\$405.00
\$510.00	\$405.00
\$355.00	\$280.00
\$355.00	\$280.00

Class 2

Set Range	Part #	Price
100 g - 1 mg	11901	\$1,060.00
100 g - 1 mg*	12160	\$1,060.00
100 g - 5 mg	12158	\$945.00
100 g - 5 mg*	-	Consult
100 g - 10 mg	11912	\$925.00
100 g - 10 mg*	12157	\$925.00
100 g - 100 mg	45957	\$900.00
100 g - 100 mg*	45949	\$900.00
100 g - 1 g	11913	\$775.00
100 g - 1 g*	12156	\$765.00

Optional Certificate

Accredited	Non-accredited
\$830.00	\$620.00
\$830.00	\$620.00
\$705.00	\$540.00
\$705.00	\$540.00
\$670.00	\$530.00
\$670.00	\$530.00
\$510.00	\$405.00
\$510.00	\$405.00
\$355.00	\$280.00
\$355.00	\$280.00

Class 3

Set Range	Part #	Price
100 g - 1 mg	12018	\$1,000.00
100 g - 1 mg*	12298	\$1,000.00
100 g - 5 mg	12031	\$885.00
100 g - 5 mg*	12296	\$885.00
100 g - 10 mg	12035	\$880.00
100 g - 10 mg*	12295	\$880.00
100 g - 100 mg	45958	\$835.00
100 g - 100 mg*	45950	\$835.00
100 g - 1 g	12045	\$745.00
100 g - 1 g*	12294	\$745.00

Optional Certificate

Accredited	Non-accredited
\$830.00	\$620.00
\$830.00	\$620.00
\$705.00	\$540.00
\$705.00	\$540.00
\$670.00	\$530.00
\$670.00	\$530.00
\$510.00	\$405.00
\$510.00	\$405.00
\$355.00	\$280.00
\$355.00	\$280.00

Class 4

Set Range	Part #	Price
100 g - 1 mg	12164	\$910.00
100 g - 1 mg*	12401	\$910.00
100 g - 5 mg	12177	\$885.00
100 g - 5 mg*	12399	\$885.00
100 g - 10 mg	12181	\$880.00
100 g - 10 mg*	12398	\$880.00
100 g - 100 mg	45959	\$740.00
100 g - 100 mg*	45951	\$740.00
100 g - 1 g	12191	\$645.00
100 g - 1 g*	12397	\$645.00

Optional Certificate

Accredited
\$505.00
\$505.00
\$430.00
\$430.00
\$395.00
\$395.00
\$305.00
\$305.00
\$215.00
\$215.00

* 5-2-2-1 configuration



PN 12457 Set Includes Lifting Device, Glove and Case

RANGE: 100 g

Weight Set Contents

5-2-2-1		5-2-2-1		5-2-2-1		5-2-2-1		5-2-2-1	
100 g - 1mg	100 g - 1mg	100 g - 5 mg	100 g - 5 mg	100 g - 10 mg	100 g - 10 mg	100 g - 100 mg	100 g - 100 mg	100 g - 1g	100 g - 1g
45930 Class 0	–	84211 Class 0	–	84212 Class 0	–	45931 Class 0	–	45932 Class 0	–
12457 Class 1	11897 Class 1	11911 Class 1	11896 Class 1	12460 Class 1	11895 Class 1	45956 Class 1	45948 Class 1	12461 Class 1	11894 Class 1
11901 Class 2	12160 Class 2	12158 Class 2	–	11912 Class 2	12157 Class 2	45957 Class 2	45949 Class 2	11913 Class 2	12156 Class 2
12018 Class 3	12298 Class 3	12031 Class 3	12296 Class 3	12035 Class 3	12295 Class 3	45958 Class 3	45950 Class 3	12045 Class 3	12294 Class 3
12164 Class 4	12401 Class 4	12177 Class 4	12399 Class 4	12181 Class 4	12398 Class 4	45959 Class 4	45951 Class 4	12191 Class 4	12397 Class 4
(1) 100 g	(1) 100 g	(1) 100 g	(1) 100 g	(1) 100 g	(1) 100 g	(1) 100 g	(1) 100 g	(1) 100 g	(1) 100 g
(1) 50 g	(1) 50 g	(1) 50 g	(1) 50 g	(1) 50 g	(1) 50 g	(1) 50 g	(1) 50 g	(1) 50 g	(1) 50 g
(1) 30 g	–	(1) 30 g	–	(1) 30 g	–	(1) 30 g	–	(1) 30 g	–
(1) 20 g	(2) 20 g	(1) 20 g	(2) 20 g	(1) 20 g	(2) 20 g	(1) 20 g	(2) 20 g	(1) 20 g	(2) 20 g
(1) 10 g	(1) 10 g	(1) 10 g	(1) 10 g	(1) 10 g	(1) 10 g	(1) 10 g	(1) 10 g	(1) 10 g	(1) 10 g
(1) 5 g	(1) 5 g	(1) 5 g	(1) 5 g	(1) 5 g	(1) 5 g	(1) 5 g	(1) 5 g	(1) 5 g	(1) 5 g
(1) 3 g	–	(1) 3 g	–	(1) 3 g	–	(1) 3 g	–	(1) 3 g	–
(1) 2 g	(2) 2 g	(1) 2 g	(2) 2 g	(1) 2 g	(2) 2 g	(1) 2 g	(2) 2 g	(1) 2 g	(2) 2 g
(1) 1 g	(1) 1 g	(1) 1 g	(1) 1 g	(1) 1 g	(1) 1 g	(1) 1 g	(1) 1 g	(1) 1 g	(1) 1 g
(1) 500 mg	(1) 500 mg	(1) 500 mg	(1) 500 mg	(1) 500 mg	(1) 500 mg	(1) 500 mg	(1) 500 mg	(1) 500 mg	
(1) 300 mg	–	(1) 300 mg	–	(1) 300 mg	–	(1) 300 mg	–	(1) 300 mg	
(1) 200 mg	(2) 200 mg	(1) 200 mg	(2) 200 mg	(1) 200 mg	(2) 200 mg	(1) 200 mg	(2) 200 mg	(1) 200 mg	
(1) 100 mg	(1) 100 mg	(1) 100 mg	(1) 100 mg	(1) 100 mg	(1) 100 mg	(1) 100 mg	(1) 100 mg	(1) 100 mg	
(1) 50 mg	(1) 50 mg	(1) 50 mg	(1) 50 mg	(1) 50 mg	(1) 50 mg	(1) 50 mg			
(1) 30 mg	–	(1) 30 mg	–	(1) 30 mg	–				
(1) 20 mg	(2) 20 mg	(1) 20 mg	(2) 20 mg	(1) 20 mg	(2) 20 mg				
(1) 10 mg	(1) 10 mg	(1) 10 mg	(1) 10 mg	(1) 10 mg	(1) 10 mg				
(1) 5 mg	(1) 5 mg	(1) 5 mg	(1) 5 mg						
(1) 3 mg	–								
(1) 2 mg	(2) 2 mg								
(1) 1 mg	(1) 1 mg								
21 pcs. 222.221g set wt.	21 pcs. 211.11g set wt.	18 pcs. 222.215g set wt.	18 pcs. 211.085g set wt.	17 pcs. 222.21g set wt.	17 pcs. 211.1g set wt.	13 pcs. 222.1g set wt.	13 pcs. 211g set wt.	9 pcs. 221g set wt.	9 pcs. 210g set wt.

ASTM
PRECISION

OIML
PRECISION

BALANCE
CALIBRATION

STAINLESS
FIELD WEIGHTS

CAST IRON
FIELD WEIGHTS

ASTM
SPECIALTY

ACCESSORIES

Replacement Cases

Main Cases		
Class 0		
Set Range	Part #	Price
100 g - 1mg	49503	\$250.00
100 g - 5 mg	49503	\$250.00
100 g - 10 mg	49503	\$250.00
100 g - 100 mg	49503	\$250.00
100 g - 1g	49503	\$250.00
Main Case		
Class 1, 2 and 3		
Set Range	Part #	Price
100 g - 1mg	11596	\$180.00
100 g - 1mg	11588	\$180.00
100 g - 5 mg	11596	\$180.00
100 g - 5 mg	11588	\$180.00
100 g - 10 mg	11596	\$180.00
100 g - 10 mg	11588	\$180.00
100 g - 100 mg	11596	\$180.00
100 g - 100 mg	11588	\$180.00

Main Case		
Class 1, 2 and 3		
Set Range	Part #	Price
100 g - 1g	11596	\$180.00
100 g - 1g	11588	\$180.00
Main Cases		
Class 4		
Set Range	Part #	Price
100 g - 1mg	11596	\$180.00
100 g - 1mg	11588	\$180.00
100 g - 5 mg	11596	\$180.00
100 g - 5 mg	11588	\$180.00
100 g - 10 mg	11596	\$180.00
100 g - 10 mg	11588	\$180.00
100 g - 100 mg	11596	\$180.00
100 g - 100 mg	11588	\$180.00
100 g - 1g	11596	\$180.00
100 g - 1g	11588	\$180.00

Accessories

Description	Part #	Price
Statement of Accuracy	36092	\$47.50
Weight glove, white cotton	11714	\$6.75
Tweezer	11711	\$5.00
Premium tweezer	152414	\$43.00
Serial number	25836	\$17.00
Leaf weight cover	11755	\$43.00

MASS REFERENCE STANDARDS / METRIC SETS

RANGE: 200 g

Class 0

Statement of Accuracy not available.

Set Range	Part #	Price
200 g - 1mg	45927	\$4,575.00
200 g - 1mg*	156298	\$4,575.00
(2) 200 g - 1mg*	87039	\$5,100.00
200 g - 10 mg	84213	\$4,125.00
(2) 200 g - 10 mg*	87038	\$4,425.00
200 g - 100 mg	45928	\$3,575.00
(2) 200 g - 100 mg*	87037	\$3,825.00
200 g - 1g	45929	\$2,400.00
(2) 200 g - 1g*	87040	\$2,850.00

Certificate

Accredited
Included
Included
Included
Included
Included
Included
Included
Included
Included
Included

Class 1

Set Range	Part #	Price
200 g - 1mg	12462	\$1,290.00
200 g - 1mg*	156299	\$1,290.00
(2) 200 g - 1mg*	87053	\$1,370.00
200 g - 10 mg	12467	\$1,180.00
(2) 200 g - 10 mg*	87049	\$1,350.00
200 g - 100 mg	45960	\$1,140.00
(2) 200 g - 100 mg*	87045	\$1,300.00
200 g - 1g	12468	\$960.00
200 g - 1g*	11893	\$960.00
(2) 200 g - 1g*	87057	\$1,100.00

Optional Certificate

Accredited	Non-accredited
\$930.00	\$660.00
\$930.00	\$660.00
\$1,020.00	\$675.00
\$770.00	\$535.00
\$870.00	\$625.00
\$610.00	\$450.00
\$700.00	\$495.00
\$450.00	\$325.00
\$450.00	\$325.00
\$540.00	\$370.00

Class 2

Set Range	Part #	Price
200 g - 1mg	11914	\$1,240.00
200 g - 1mg*	156300	\$1,240.00
(2) 200 g - 1mg*	87054	\$1,290.00
200 g - 10 mg	11916	\$1,010.00
(2) 200 g - 10 mg*	87050	\$1,260.00
200 g - 100 mg	45961	\$970.00
(2) 200 g - 100 mg*	87046	\$1,230.00
200 g - 1g	11917	\$900.00
200 g - 1g*	12154	\$900.00
(2) 200 g - 1g*	87058	\$930.00

Optional Certificate

Accredited	Non-accredited
\$930.00	\$660.00
\$930.00	\$660.00
\$1,020.00	\$675.00
\$770.00	\$535.00
\$870.00	\$625.00
\$610.00	\$450.00
\$700.00	\$495.00
\$450.00	\$325.00
\$450.00	\$325.00
\$540.00	\$370.00

Class 3

Set Range	Part #	Price
200 g - 1mg	12051	\$1,220.00
200 g - 1mg*	156301	\$1,220.00
(2) 200 g - 1mg*	87055	\$1,290.00
200 g - 10 mg	12064	\$985.00
(2) 200 g - 10 mg*	87051	\$1,230.00
200 g - 100 mg	45962	\$900.00
(2) 200 g - 100 mg*	87047	\$1,220.00
200 g - 1g	12065	\$890.00
200 g - 1g*	12292	\$890.00
(2) 200 g - 1g*	87059	\$925.00

Optional Certificate

Accredited	Non-accredited
\$930.00	\$660.00
\$930.00	\$660.00
\$1,020.00	\$675.00
\$770.00	\$535.00
\$870.00	\$625.00
\$610.00	\$450.00
\$700.00	\$495.00
\$450.00	\$325.00
\$450.00	\$325.00
\$540.00	\$370.00

Class 4

Set Range	Part #	Price
200 g - 1mg	12197	\$960.00
200 g - 1mg*	156302	\$960.00
(2) 200 g - 1mg*	87056	\$1,040.00
200 g - 10 mg	12210	\$915.00
(2) 200 g - 10 mg*	87052	\$1,000.00
200 g - 100 mg	45963	\$820.00
(2) 200 g - 100 mg*	87048	\$960.00
200 g - 1g	12211	\$700.00
200 g - 1g*	12395	\$700.00
(2) 200 g - 1g*	87060	\$815.00

Optional Certificate

Accredited
\$530.00
\$530.00
\$560.00
\$440.00
\$470.00
\$340.00
\$375.00
\$245.00
\$245.00
\$280.00

Weight Set Contents

5-2-2-1

200 g - 1 mg		200 g - 1 mg	
45927 Class 0		156298 Class 0	
12462 Class 1		156299 Class 1	
11914 Class 2		156300 Class 2	
12051 Class 3		156301 Class 3	
12197 Class 4		156302 Class 4	
(1) 200 g		(1) 200 g	
(1) 100 g		(1) 100 g	
(1) 50 g		(1) 50 g	
(1) 30 g		-	
(1) 20 g		(2) 20 g	
(1) 10 g		(1) 10 g	
(1) 5 g		(1) 5 g	
(1) 3 g		-	
(1) 2 g		(2) 2 g	
(1) 1g		(1) 1g	
(1) 500 mg		(1) 500 mg	
(1) 300 mg		-	
(1) 200 mg		(2) 200 mg	
(1) 100 mg		(1) 100 mg	
(1) 50 mg		(1) 50 mg	
(1) 30 mg		-	
(1) 20 mg		(2) 20 mg	
(1) 10 mg		(1) 10 mg	
(1) 5 mg		(1) 5 mg	
(1) 3 mg		-	
(1) 2 mg		(2) 2 mg	
(1) 1 mg		(1) 1 mg	
22 pcs. 422.221g set wt.		22 pcs. 422.221g set wt.	



PN 12462 Set Includes Lifting Device, Glove and Case

* 5-2-2-1 configuration

RANGE: 200 g

Weight Set Contents

5-2-2-1		5-2-2-1		5-2-2-1		5-2-2-1		5-2-2-1		5-2-2-1	
(2) 200 g - 1mg		200 g - 10 mg		(2) 200 g - 10 mg		200 g - 100 mg		(2) 200 g - 100 mg		200 g - 1g	
87039 Class 0	84213 Class 0	87038 Class 0	45928 Class 0	87037 Class 0	45929 Class 0	-	87040 Class 0	(2) 200 g	(1) 200 g	(1) 200 g	(2) 200 g
87053 Class 1	12467 Class 1	87049 Class 1	45960 Class 1	87045 Class 1	12468 Class 1	11893 Class 1	87057 Class 1	(1) 100 g	(1) 100 g	(1) 100 g	(1) 100 g
87054 Class 2	11916 Class 2	87050 Class 2	45961 Class 2	87046 Class 2	11917 Class 2	12154 Class 2	87058 Class 2	(1) 50 g	(1) 50 g	(1) 50 g	(1) 50 g
87055 Class 3	12064 Class 3	87051 Class 3	45962 Class 3	87047 Class 3	12065 Class 3	12292 Class 3	87059 Class 3	-	(2) 20 g	(2) 20 g	(2) 20 g
87056 Class 4	12210 Class 4	87052 Class 4	45963 Class 4	87048 Class 4	12211 Class 4	12395 Class 4	87060 Class 4	(1) 30 g	(1) 10 g	(1) 10 g	(1) 10 g
(2) 200 g	(1) 200 g	(2) 200 g	(1) 200 g	(2) 200 g	(1) 200 g	(1) 200 g	(2) 20 g	(1) 20 g	(1) 5 g	(1) 5 g	(1) 5 g
(1) 100 g	(1) 100 g	(1) 100 g	(1) 100 g	(1) 100 g	(1) 100 g	(1) 100 g	(1) 10 g	(1) 10 g	-	-	-
(1) 50 g	(1) 50 g	(1) 50 g	(1) 50 g	(1) 50 g	(1) 50 g	(1) 50 g	(1) 5 g	(1) 5 g	(2) 2 g	(2) 2 g	(2) 2 g
-	(1) 30 g	-	(1) 30 g	-	(1) 30 g	(1) 30 g	(1) 3 g	(1) 3 g	(1) 1 g	(1) 1 g	(1) 1 g
(2) 20 g	(1) 20 g	(2) 20 g	(1) 20 g	(2) 20 g	(1) 20 g	(1) 20 g	(2) 2 g	(2) 2 g	(1) 500 mg	(1) 500 mg	(1) 500 mg
(1) 10 g	(1) 10 g	(1) 10 g	(1) 10 g	(1) 10 g	(1) 10 g	(1) 10 g	(1) 2 g	(1) 2 g	-	-	-
(1) 5 g	(1) 5 g	(1) 5 g	(1) 5 g	(1) 5 g	(1) 5 g	(1) 5 g	(1) 1 g	(1) 1 g	(1) 300 mg	(1) 300 mg	(1) 300 mg
-	(1) 3 g	-	(1) 3 g	-	(1) 3 g	(1) 3 g	(1) 500 mg	(1) 500 mg	(2) 200 mg	(2) 200 mg	(2) 200 mg
(2) 2 g	(1) 2 g	(2) 2 g	(1) 2 g	(2) 2 g	(1) 2 g	(1) 2 g	-	-	(1) 100 mg	(1) 100 mg	(1) 100 mg
(1) 1 g	(1) 1 g	(1) 1 g	(1) 1 g	(1) 1 g	(1) 1 g	(1) 1 g	(2) 200 mg	(2) 200 mg	(1) 50 mg	(1) 50 mg	(1) 50 mg
(1) 500 mg	(1) 500 mg	(1) 500 mg	(1) 500 mg	(1) 500 mg	(1) 500 mg	(1) 500 mg	(1) 100 mg	(1) 100 mg	-	(1) 30 mg	-
-	(1) 300 mg	-	(1) 300 mg	-	(1) 300 mg	(1) 300 mg	(2) 20 mg	(2) 20 mg	(2) 20 mg	(1) 20 mg	(2) 20 mg
(2) 200 mg	(1) 200 mg	(2) 200 mg	(1) 200 mg	(2) 200 mg	(1) 200 mg	(1) 200 mg	(1) 10 mg	(1) 10 mg	(1) 10 mg	(1) 10 mg	(1) 10 mg
(1) 100 mg	(1) 100 mg	(1) 100 mg	(1) 100 mg	(1) 100 mg	(1) 100 mg	(1) 100 mg	(1) 5 mg	(1) 5 mg	-	-	-
(1) 50 mg	(1) 50 mg	(1) 50 mg	(1) 50 mg	(1) 50 mg	(1) 50 mg	(1) 50 mg	(2) 2 mg	(2) 2 mg	(2) 2 mg	(2) 2 mg	(2) 2 mg
-	(1) 30 mg	-	(1) 30 mg	-	(1) 30 mg	(1) 30 mg	(1) 1 mg	(1) 1 mg	(1) 1 mg	(1) 1 mg	(1) 1 mg
(2) 20 mg	(1) 20 mg	(2) 20 mg	(1) 20 mg	(2) 20 mg	(1) 20 mg	(1) 20 mg	-	-	-	-	-
(1) 10 mg	(1) 10 mg	(1) 10 mg	(1) 10 mg	(1) 10 mg	(1) 10 mg	(1) 10 mg	-	-	-	-	-
(1) 5 mg	-	-	-	-	-	-	-	-	-	-	-
-	-	-	-	-	-	-	-	-	-	-	-
(2) 2 mg	-	-	-	-	-	-	-	-	-	-	-
(1) 1 mg	-	-	-	-	-	-	-	-	-	-	-
23 pcs. 622.221g set wt.	18 pcs. 422.210g set wt.	19 pcs. 611.1g set wt.	14 pcs. 422.19g set wt.	15 pcs. 611g set wt.	10 pcs. 421g set wt.	10 pcs. 410g set wt.	11 pcs. 610g set wt.				

Replacement Cases

Main Cases		
Class 0		
Set Range	Part #	Price
200 g - 1mg	34645	\$330.00
200 g - 1mg	34645	\$330.00
(2) 200 g - 1mg	34645	\$330.00
200 g - 10 mg	34645	\$330.00
(2) 200 g - 10 mg	34645	\$330.00
200 g - 100 mg	34645	\$330.00
(2) 200 g - 100 mg	34645	\$330.00
200 g - 1g	34645	\$330.00
(2) 200 g - 1g	34645	\$330.00

Main Case		
Class 1, 2 and 3		
Set Range	Part #	Price
200 g - 1mg	34645	\$330.00
200 g - 1mg	34645	\$330.00
(2) 200 g - 1mg	34645	\$330.00
200 g - 10 mg	34645	\$330.00
(2) 200 g - 10 mg	34645	\$330.00
200 g - 100 mg	34645	\$330.00
(2) 200 g - 100 mg	34645	\$330.00
200 g - 1g	34645	\$330.00
200 g - 1g	34645	\$330.00
(2) 200 g - 1g	34645	\$330.00

Main Cases		
Class 4		
Set Range	Part #	Price
200 g - 1mg	34645	\$330.00
200 g - 1mg	34645	\$330.00
(2) 200 g - 1mg	34645	\$330.00
200 g - 10 mg	34645	\$330.00
(2) 200 g - 10 mg	34645	\$330.00
200 g - 100 mg	34645	\$330.00
(2) 200 g - 100 mg	34645	\$330.00
200 g - 1g	34645	\$330.00
200 g - 1g	34645	\$330.00
(2) 200 g - 1g	34645	\$330.00

Inserts		
Class 0		
Set Range	Part #	Price
200 g - 1mg	50431	\$125.00
(2) 200 g - 1mg	84473	\$400.00
(2) 200 g - 10 mg	84473	\$400.00
(2) 200 g - 100 mg	84473	\$400.00
200 g - 1g	50430	\$125.00
(2) 200 - 1g	84472	\$400.00

Inserts		
Class 1, 2, 3 and 4		
Set Range	Part #	Price
200 g - 1mg	11601	\$195.00
(2) 200 g - 1g	84465	\$195.00
(2) 200 g - 1mg	84464	\$195.00
200 g - 1g*	11587	\$195.00

Accessories

Description	Part #	Price
Statement of Accuracy	36092	\$47.50
Weight glove, white cotton	11714	\$6.75
Tweezer	11711	\$5.00
Premium tweezer	152414	\$43.00
Serial number	25836	\$17.00
Leaf weight cover	11755	\$43.00
Weight forceps, plastic	50035	\$43.00
Lifter bar	11747	\$21.00

MASS REFERENCE STANDARDS / METRIC SETS

RANGE: 300 g and 500 g

Class 0

Statement of Accuracy not available.

Set Range	Part #	Price
500 g - 1mg	45923	\$5,750.00
500 g - 100 mg	45924	\$4,525.00
500 g - 1g	45925	\$3,750.00
500 g - 100 g	45926	\$2,350.00

Certificate

Accredited
Included
Included
Included
Included

Class 1

Set Range	Part #	Price
300 g - 1g	11892	\$1,610.00
500 g - 1mg	12469	\$2,675.00
500 g - 100 mg	45964	\$2,625.00
500 g - 1g	12472	\$1,760.00
500 g - 1g*	11891	\$1,760.00
500 g - 100 g	45968	\$1,240.00

Optional Certificate

Accredited	Non-accredited
\$540.00	\$370.00
\$1,120.00	\$535.00
\$800.00	\$410.00
\$640.00	\$410.00
\$640.00	\$165.00
\$325.00	\$165.00

Class 2

Set Range	Part #	Price
300 g - 1g	12152	\$1,480.00
500 g - 1mg	11918	\$2,060.00
500 g - 100 mg	45965	\$1,940.00
500 g - 1g	11921	\$1,610.00
500 g - 1g*	12151	\$1,610.00
500 g - 100 g	45969	\$1,140.00

Optional Certificate

Accredited	Non-accredited
\$540.00	\$370.00
\$1,120.00	\$715.00
\$800.00	\$535.00
\$640.00	\$410.00
\$640.00	\$395.00
\$325.00	\$165.00

Class 3

Set Range	Part #	Price
300 g - 1g	12290	\$1,420.00
500 g - 1mg	12066	\$2,010.00
500 g - 100 mg	45966	\$1,840.00
500 g - 1g	12069	\$1,570.00
500 g - 1g*	12289	\$1,570.00
500 g - 100 g	45970	\$1,120.00

Optional Certificate

Accredited	Non-accredited
\$540.00	\$370.00
\$1,120.00	\$715.00
\$800.00	\$535.00
\$640.00	\$410.00
\$640.00	\$395.00
\$325.00	\$165.00

Class 4

Set Range	Part #	Price
300 g - 1g	12393	\$1,310.00
500 g - 1mg	12212	\$1,840.00
500 g - 100 mg	45967	\$1,640.00
500 g - 1g	12215	\$1,450.00
500 g - 1g*	12392	\$1,450.00
500 g - 100 g	45971	\$955.00

Optional Certificate

Accredited
\$280.00
\$605.00
\$375.00
\$310.00
\$310.00
\$125.00

* 5-2-2-1 configuration



PN 12151 Set Includes Lifting Device, Glove and Case (500 g to 1 g)

Replacement Cases

Main Cases		
Class 0		
Set Range	Part #	Price
500 g - 1mg	34645	\$330.00
500 g - 100 mg	34645	\$330.00
500 g - 1g	34645	\$330.00
500 g - 100 g	34645	\$330.00

Main Case		
Class 1, 2 and 3		
Set Range	Part #	Price
300 g - 1g	34645	\$330.00
500 g - 1mg	34645	\$330.00
500 g - 100 mg	34645	\$330.00
500 g - 1g	34645	\$330.00
500 g - 1g	34645	\$330.00
500 g - 100 g	34645	\$330.00

Main Cases		
Class 4		
Set Range	Part #	Price
300 g - 1g	34645	\$330.00
500 g - 1mg	34645	\$330.00
500 g - 100 mg	34645	\$330.00
500 g - 1g	34645	\$330.00
500 g - 1g	34645	\$330.00
500 g - 100 g	34645	\$330.00

RANGE: 300 g and 500 g

Weight Set Contents

5-2-2-1

300 g - 1g	500 g - 1mg	500 g - 100 mg	500 g - 1g	500 g - 1g	500 g - 100 g
–	45923 Class 0	45924 Class 0	45925 Class 0	–	45926 Class 0
11892 Class 1	12469 Class 1	45964 Class 1	12472 Class 1	11891 Class 1	45968 Class 1
12152 Class 2	11918 Class 2	45965 Class 2	11921 Class 2	12151 Class 2	45969 Class 2
12290 Class 3	12066 Class 3	45966 Class 3	12069 Class 3	12289 Class 3	45970 Class 3
12393 Class 4	12212 Class 4	45967 Class 4	12215 Class 4	12392 Class 4	45971 Class 4
–	(1) 500 g	(1) 500 g	(1) 500 g	(1) 500 g	(1) 500 g
(1) 300 g	(1) 300 g	(1) 300 g	(1) 300 g	–	(1) 300 g
(1) 200 g	(1) 200 g	(1) 200 g	(1) 200 g	(2) 200 g	(1) 200 g
(1) 100 g	(1) 100 g	(1) 100 g	(1) 100 g	(1) 100 g	(1) 100 g
(1) 50 g	(1) 50 g	(1) 50 g	(1) 50 g	(1) 50 g	
(1) 30 g	(1) 30 g	(1) 30 g	(1) 30 g	–	
(1) 20 g	(1) 20 g	(1) 20 g	(1) 20 g	(2) 20 g	
(1) 10 g	(1) 10 g	(1) 10 g	(1) 10 g	(1) 10 g	
(1) 5 g	(1) 5 g	(1) 5 g	(1) 5 g	(1) 5 g	
(1) 3 g	(1) 3 g	(1) 3 g	(1) 3 g	–	
(1) 2 g	(1) 2 g	(1) 2 g	(1) 2 g	(2) 2 g	
(1) 1g	(1) 1g	(1) 1g	(1) 1g	(1) 1g	
	(1) 500 mg	(1) 500 mg			
	(1) 300 mg	(1) 300 mg			
	(1) 200 mg	(1) 200 mg			
	(1) 100 mg	(1) 100 mg			
	(1) 50 mg				
	(1) 30 mg				
	(1) 20 mg				
	(1) 10 mg				
	(1) 5 mg				
	(1) 3 mg				
	(1) 2 mg				
	(1) 1 mg				
11 pcs. 721g set wt.	24 pcs. 1.222221 kg set wt.	16 pcs. 1.2221 kg set wt.	12 pcs. 1.221 kg set wt.	12 pcs. 1.10 kg set wt.	4 pcs. 1.1 kg set wt.

ASTM
PRECISION

OIML
PRECISION

BALANCE
CALIBRATION

STAINLESS
FIELD WEIGHTS

CAST IRON
FIELD WEIGHTS

ASTM
SPECIALTY

ACCESSORIES

Accessories

Inserts		
Class 0		
Set Range	Part #	Price
500 g - 1mg	49500	\$260.00
500 g - 100 g	49501	\$205.00

Inserts		
Class 1, 2, 3 and 4		
Set Range	Part #	Price
300 g - 1g	11586	\$195.00
500 g - 1mg	11602	\$195.00
500 g - 1g*	11585	\$195.00

* 5-2-2-1 configuration

Description	Part #	Price
Statement of Accuracy	36092	\$47.50
Weight glove, white cotton	11714	\$6.75
Tweezer	11711	\$5.00
Premium tweezer	152414	\$43.00
Serial number	25836	\$17.00
Leaf weight cover	11755	\$43.00
Weight forceps, plastic	50035	\$43.00
Lifter bar	11747	\$21.00

MASS REFERENCE STANDARDS / METRIC SETS

RANGE: 1kg

Class 0

Statement of Accuracy not available.

Set Range	Part #	Price
1kg - 1mg	45919	\$6,625.00
1kg - 100 mg	45920	\$5,475.00
1kg - 1g	45921	\$4,600.00
1kg - 100 g	45922	\$3,375.00

Certificate

Accredited
Included
Included
Included
Included

Class 1

Set Range	Part #	Price
1kg - 1mg	12473	\$3,175.00
1kg - 100 mg	45972	\$3,100.00
1kg - 1g	12476	\$2,825.00
1kg - 1g*	11889	\$2,825.00
1kg - 100 g	45976	\$2,575.00

Optional Certificate

Accredited	Non-accredited
\$1,210.00	\$765.00
\$900.00	\$525.00
\$730.00	\$455.00
\$730.00	\$455.00
\$415.00	\$205.00

Class 2

Set Range	Part #	Price
1kg - 1mg	11922	\$2,900.00
1kg - 100 mg	45973	\$2,875.00
1kg - 1g	11925	\$2,725.00
1kg - 1g*	12149	\$2,725.00
1kg - 100 g	45977	\$2,490.00

Optional Certificate

Accredited	Non-accredited
\$1,210.00	\$765.00
\$900.00	\$525.00
\$730.00	\$455.00
\$730.00	\$455.00
\$415.00	\$205.00

Class 3

Set Range	Part #	Price
1kg - 1mg	12070	\$2,875.00
1kg - 100 mg	45974	\$2,825.00
1kg - 1g	12073	\$2,600.00
1kg - 1g*	12288	\$2,600.00
1kg - 100 g	45978	\$2,440.00

Optional Certificate

Accredited	Non-accredited
\$1,210.00	\$765.00
\$900.00	\$525.00
\$730.00	\$455.00
\$730.00	\$455.00
\$415.00	\$205.00

Class 4

Set Range	Part #	Price
1kg - 1mg	12216	\$2,650.00
1kg - 100 mg	45975	\$2,600.00
1kg - 1g	12219	\$2,525.00
1kg - 1g*	12391	\$2,440.00
1kg - 100 g	45979	\$2,170.00

Optional Certificate

Accredited
\$630.00
\$445.00
\$350.00
\$350.00
\$155.00

* 5-2-2-1 configuration



PN 12473 Set Includes Lifting Device, Glove and Case (1 kg to 1 mg)

Replacement Cases

Main Cases		
Class 0		
Set Range	Part #	Price
1kg - 1mg	50437	\$1,820.00
1kg - 100 mg	50437	\$1,820.00
1kg - 1g	50437	\$1,820.00
1kg - 100 g	50437	\$1,820.00

Main Case		
Class 1, 2 and 3		
Set Range	Part #	Price
1kg - 1mg	11603	\$1,820.00
1kg - 100 mg	11603	\$1,820.00
1kg - 1g	11603	\$1,820.00
1kg - 1g	11584	\$1,580.00
1kg - 100 g	11603	\$1,820.00

Main Cases		
Class 4		
Set Range	Part #	Price
1kg - 1mg	11603	\$1,820.00
1kg - 100 mg	11603	\$1,820.00
1kg - 1g	11603	\$1,820.00
1kg - 1g	11605	\$1,580.00
1kg - 100 g	11603	\$1,820.00

RANGE: 1kg

ASTM
PRECISION

Weight Set Contents

5-2-2-1

1kg - 1mg	1kg - 100 mg	1kg - 1g	1kg - 1g	1kg - 100 g
45919 Class 0	45920 Class 0	45921 Class 0	–	45922 Class 0
12473 Class 1	45972 Class 1	12476 Class 1	11889 Class 1	45976 Class 1
11922 Class 2	45973 Class 2	11925 Class 2	12149 Class 2	45977 Class 2
12070 Class 3	45974 Class 3	12073 Class 3	12288 Class 3	45978 Class 3
12216 Class 4	45975 Class 4	12219 Class 4	12391 Class 4	45979 Class 4
(1) 1kg	(1) 1kg	(1) 1kg	(1) 1kg	(1) 1kg
(1) 500g	(1) 500g	(1) 500g	(1) 500g	(1) 500g
(1) 300g	(1) 300g	(1) 300g	–	(1) 300g
(1) 200g	(1) 200g	(1) 200g	(2) 200g	(1) 200g
(1) 100g	(1) 100g	(1) 100g	(1) 100g	(1) 100g
(1) 50g	(1) 50g	(1) 50g	(1) 50g	
(1) 30g	(1) 30g	(1) 30g	–	
(1) 20g	(1) 20g	(1) 20g	(2) 20g	
(1) 10g	(1) 10g	(1) 10g	(1) 10g	
(1) 5g	(1) 5g	(1) 5g	(1) 5g	
(1) 3g	(1) 3g	(1) 3g	–	
(1) 2g	(1) 2g	(1) 2g	(2) 2g	
(1) 1g	(1) 1g	(1) 1g	(1) 1g	
(1) 500 mg	(1) 500 mg			
(1) 300 mg	(1) 300 mg			
(1) 200 mg	(1) 200 mg			
(1) 100 mg	(1) 100 mg			
(1) 50 mg				
(1) 30 mg				
(1) 20 mg				
(1) 10 mg				
(1) 5 mg				
(1) 3 mg				
(1) 2 mg				
(1) 1 mg				
25 pcs. 2.22221kg set wt.	17 pcs. 2.2221kg set wt.	13 pcs. 2.221kg set wt.	13 pcs. 2.11kg set wt.	5 pcs. 2.1kg set wt.

OIML
PRECISION

BALANCE
CALIBRATION

STAINLESS
FIELD WEIGHTS

CAST IRON
FIELD WEIGHTS

ASTM
SPECIALTY

ACCESSORIES

Secondary Case		
Class 0		
Set Range	Part #	Price
100g - 1mg	49503	\$250.00

Secondary Case		
Class 1, 2, 3 and 4		
Set Range	Part #	Price
100g - 1mg	11596	\$180.00
100g - 1mg*	11588	\$180.00

* 5-2-2-1 configuration

Inserts		
Class 1, 2, 3 and 4		
Set Range	Part #	Price
100g	46380	\$120.00

Accessories

Description	Part #	Price
Statement of Accuracy	36092	\$47.50
Weight glove, white cotton	11714	\$6.75
Tweezer	11711	\$5.00
Premium tweezer	152414	\$43.00
Serial number	25836	\$17.00
Leaf weight cover	11755	\$43.00
Weight forceps, plastic	50035	\$43.00
Lifter bar	11747	\$21.00
Tong assembly, Class 0	50000	\$74.00

MASS REFERENCE STANDARDS / METRIC SETS

RANGE: 2 kg

Class 0

Statement of Accuracy not available.

Set Range	Part #	Price
2 kg - 1 mg	45915	\$8,475.00
(2) 2 kg - 1 mg*	87043	\$10,150.00
(2) 2 kg - 10 mg*	87042	\$9,625.00
2 kg - 100 mg	45916	\$8,150.00
(2) 2 kg - 100 mg	87041	\$9,000.00
2 kg - 1 g	45917	\$6,100.00
(2) 2 kg - 1 g	87044	\$7,875.00
2 kg - 100 g	45918	\$4,925.00

Certificate

Accredited
Included
Included
Included
Included
Included
Included
Included
Included

Class 1

Set Range	Part #	Price
2 kg - 1 mg	12477	\$4,075.00
(2) 2 kg - 1 mg*	87069	\$4,550.00
(2) 2 kg - 10 mg*	87065	\$4,475.00
2 kg - 100 mg	45980	\$4,325.00
(2) 2 kg - 100 mg*	87061	\$4,425.00
2 kg - 1 g	12480	\$3,450.00
2 kg - 1 g*	11888	\$3,450.00
(2) 2 kg - 1 g*	87073	\$4,225.00
2 kg - 100 g	45984	\$3,325.00

Optional Certificate

Accredited	Non-accredited
\$1,310.00	\$900.00
\$1,430.00	\$960.00
\$1,270.00	\$830.00
\$1,000.00	\$640.00
\$1,120.00	\$700.00
\$840.00	\$510.00
\$840.00	\$510.00
\$960.00	\$570.00
\$520.00	\$260.00

Class 2

Set Range	Part #	Price
2 kg - 1 mg	11926	\$3,625.00
(2) 2 kg - 1 mg*	87070	\$4,375.00
(2) 2 kg - 10 mg*	87066	\$4,075.00
2 kg - 100 mg	45981	\$3,800.00
(2) 2 kg - 100 mg*	87062	\$3,925.00
2 kg - 1 g	11929	\$3,250.00
2 kg - 1 g*	12148	\$3,250.00
(2) 2 kg - 1 g*	87074	\$3,925.00
2 kg - 100 g	45985	\$3,175.00

Optional Certificate

Accredited	Non-accredited
\$1,310.00	\$900.00
\$1,430.00	\$960.00
\$1,270.00	\$830.00
\$1,000.00	\$640.00
\$1,120.00	\$700.00
\$840.00	\$510.00
\$840.00	\$510.00
\$960.00	\$570.00
\$520.00	\$260.00

Class 3

Set Range	Part #	Price
2 kg - 1 mg	12074	\$3,575.00
(2) 2 kg - 1 mg*	87071	\$4,225.00
(2) 2 kg - 10 mg*	87067	\$3,900.00
2 kg - 100 mg	45982	\$3,725.00
(2) 2 kg - 100 mg*	87063	\$3,725.00
2 kg - 1 g	12077	\$3,175.00
2 kg - 1 g*	12287	\$3,175.00
(2) 2 kg - 1 g*	87075	\$3,800.00
2 kg - 100 g	45986	\$2,975.00

Optional Certificate

Accredited	Non-accredited
\$1,310.00	\$900.00
\$1,430.00	\$960.00
\$1,270.00	\$830.00
\$1,000.00	\$640.00
\$1,120.00	\$700.00
\$840.00	\$510.00
\$840.00	\$510.00
\$960.00	\$570.00
\$520.00	\$260.00

Class 4

Set Range	Part #	Price
2 kg - 1 mg	12220	\$3,200.00
(2) 2 kg - 1 mg*	87072	\$3,900.00
(2) 2 kg - 10 mg*	87068	\$3,550.00
2 kg - 100 mg	45983	\$3,700.00
(2) 2 kg - 100 mg*	87064	\$3,525.00
2 kg - 1 g	12223	\$3,050.00
2 kg - 1 g*	12390	\$3,050.00
(2) 2 kg - 1 g*	87076	\$3,300.00
2 kg - 100 g	45987	\$2,850.00

Optional Certificate

Accredited
\$640.00
\$730.00
\$640.00
\$490.00
\$540.00
\$395.00
\$395.00
\$450.00
\$210.00

* 5-2-2-1 configuration



PN 12477 Set Includes Lifting Device, Glove and Case (2kg to 1mg)

RANGE: 2 kg

ASTM
PRECISION

Weight Set Contents

5-2-2-1		5-2-2-1		5-2-2-1		5-2-2-1		5-2-2-1	
2 kg - 1mg	(2) 2 kg - 1mg	(2) 2 kg - 10mg	2 kg - 100mg	(2) 2 kg - 100mg	2 kg - 1g	2 kg - 1g	(2) 2 kg - 1g	2 kg - 100g	
45915 Class 0	87043 Class 0	87042 Class 0	45916 Class 0	87041 Class 0	45917 Class 0	–	87044 Class 0	45918 Class 0	
12477 Class 1	87069 Class 1	87065 Class 1	45980 Class 1	87061 Class 1	12480 Class 1	11888 Class 1	87073 Class 1	45984 Class 1	
11926 Class 2	87070 Class 2	87066 Class 2	45981 Class 2	87062 Class 2	11929 Class 2	12148 Class 2	87074 Class 2	45985 Class 2	
12074 Class 3	87071 Class 3	87067 Class 3	45982 Class 3	87063 Class 3	12077 Class 3	12287 Class 3	87075 Class 3	45986 Class 3	
12220 Class 4	87072 Class 4	87068 Class 4	45983 Class 4	87064 Class 4	12223 Class 4	12390 Class 4	87076 Class 4	45987 Class 4	
(1) 2 kg	(2) 2 kg	(2) 2 kg	(1) 2 kg	(2) 2 kg	(1) 2 kg	(1) 2 kg	(2) 2 kg	(1) 2 kg	
(1) 1kg	(1) 1kg	(1) 1kg	(1) 1kg	(1) 1kg	(1) 1kg	(1) 1kg	(1) 1kg	(1) 1kg	
(1) 500g	(1) 500g	(1) 500g	(1) 500g	(1) 500g	(1) 500g	(1) 500g	(1) 500g	(1) 500g	
(1) 300g	–	–	(1) 300g	–	(1) 300g	–	–	(1) 300g	
(1) 200g	(2) 200g	(2) 200g	(1) 200g	(2) 200g	(1) 200g	(1) 200g	(1) 200g	(1) 200g	
(1) 100g	(1) 100g	(1) 100g	(1) 100g	(1) 100g	(1) 100g	(1) 100g	(1) 100g	(1) 100g	
(1) 50g	(1) 50g	(1) 50g	(1) 50g	(1) 50g	(1) 50g	(1) 50g	(1) 50g	(1) 100g	
(1) 30g	–	–	(1) 30g	–	(1) 30g	–	–		
(1) 20g	(2) 20g	(2) 20g	(1) 20g	(2) 20g	(1) 20g	(1) 20g	(1) 20g		
(1) 10g	(1) 10g	(1) 10g	(1) 10g	(1) 10g	(1) 10g	(1) 10g	(1) 10g		
(1) 5g	(1) 5g	(1) 5g	(1) 5g	(1) 5g	(1) 5g	(1) 5g	(1) 5g		
(1) 3g	–	–	(1) 3g	–	(1) 3g	–	–		
(1) 2g	(2) 2g	(2) 2g	(1) 2g	(2) 2g	(1) 2g	(1) 2g	(1) 2g		
(1) 1g	(1) 1g	(1) 1g	(1) 1g	(1) 1g	(1) 1g	(1) 1g	(1) 1g		
(1) 500mg	(1) 500mg	(1) 500mg	(1) 500mg	(1) 500mg					
(1) 300mg	–	–	(1) 300mg	–					
(1) 200mg	(2) 200mg	(2) 200mg	(1) 200mg	(2) 200mg					
(1) 100mg	(1) 100mg	(1) 100mg	(1) 100mg	(1) 100mg					
(1) 50mg	(1) 50mg	(1) 50mg	(1) 50mg						
(1) 30mg	–	–							
(1) 20mg	(2) 20mg	(2) 20mg							
(1) 10mg	(1) 10mg	(1) 10mg							
(1) 5mg	(1) 5mg	(1) 10mg							
(1) 3mg	–								
(1) 2mg	(2) 2mg								
(1) 1mg	(1) 1mg								
26 pcs. 4.222221kg set wt.	27 pcs. 6.222221kg set wt.	23 pcs. 6.22kg set wt.	18 pcs. 4.2221kg set wt.	19 pcs. 6.2221kg set wt.	14 pcs. 4.11kg set wt.	14 pcs. 4.11kg set wt.	15 pcs. 6.221kg set wt.	6 pcs. 4.1kg set wt.	

OIML
PRECISION

BALANCE
CALIBRATION

STAINLESS
FIELD WEIGHTS

CAST IRON
FIELD WEIGHTS

ASTM
SPECIALTY

Replacement Cases

Main Cases		
Class 0		
Set Range	Part #	Price
2 kg - 1mg	50439	\$1,850.00
(2) 2 kg - 1mg	84474	\$1,970.00
(2) 2 kg - 10mg	84474	\$1,970.00
2 kg - 100mg	50439	\$1,850.00
(2) 2 kg - 100mg	84474	\$1,970.00
2 kg - 1g	50439	\$1,850.00
(2) 2 kg - 1g	84474	\$1,970.00
2 kg - 100g	50438	\$1,850.00

Main Case		
Class 1, 2 and 3		
Set Range	Part #	Price
2 kg - 1mg	11604	\$1,580.00
(2) 2 kg - 1mg	84463	\$1,590.00
(2) 2 kg - 10mg	84463	\$1,590.00
2 kg - 100mg	11604	\$1,580.00
(2) 2 kg - 100mg	84463	\$1,590.00
2 kg - 1g	11604	\$1,580.00
2 kg - 1g	11583	\$1,820.00
(2) 2 kg - 1g	84463	\$1,590.00
2 kg - 100g	11604	\$1,580.00

Main Cases		
Class 4		
Set Range	Part #	Price
2 kg - 1mg	11604	\$1,580.00
(2) 2 kg - 1mg	84463	\$1,590.00
(2) 2 kg - 10mg	84463	\$1,590.00
2 kg - 100mg	11604	\$1,580.00
(2) 2 kg - 100mg	84463	\$1,590.00
2 kg - 1g	11604	\$1,580.00
2 kg - 1g	11583	\$1,820.00
(2) 2 kg - 1g	84463	\$1,590.00
2 kg - 100g	11604	\$1,580.00

Secondary Case		
Class 0		
Set Range	Part #	Price
100 g - 1mg	34697	\$225.00
100 g - 1mg	49503	\$250.00

Secondary Case		
Class 1, 2, 3 and 4		
Set Range	Part #	Price
100 g - 1mg	11588	\$180.00
100 g - 1mg	11596	\$180.00

Insert		
Wooden		
Set Range	Part #	Price
100 g	46380	\$120.00

Accessories

Description	Part #	Price
Statement of Accuracy	36092	\$47.50
Weight glove, white cotton	11714	\$6.75
Tweezer	11711	\$5.00
Premium tweezer	152414	\$43.00
Serial number	25836	\$17.00
Leaf weight cover	11755	\$43.00
Weight forceps, plastic	50035	\$43.00
Lifter bar	11747	\$21.00
Lifter bar, large handle	11712	\$73.00
Tong assembly, Class 0	50000	\$74.00
Lifter (Class 0 and OIML 2kg and 5kg)	50037	\$54.00

ACCESSORIES

MASS REFERENCE STANDARDS / METRIC SETS

RANGE: 3 kg and 5 kg

Class 0

Statement of Accuracy not available.

Set Range	Part #	Price
5 kg - 1 mg	45910	\$11,500.00
5 kg - 100 mg	45911	\$10,775.00
5 kg - 1 g	45912	\$9,425.00
5 kg - 100 g	45913	\$7,925.00

Certificate

Accredited
Included
Included
Included
Included

Class 1

Set Range	Part #	Price
3 kg - 1 g	11887	\$4,500.00
5 kg - 1 mg	12481	\$6,000.00
5 kg - 1 mg*	114050	\$6,000.00
5 kg - 100 mg	45988	\$5,675.00
5 kg - 1 g	12484	\$5,325.00
5 kg - 1 g*	11886	\$5,325.00
5 kg - 100 g	45992	\$4,925.00

Optional Certificate

Accredited	Non-accredited
\$960.00	\$515.00
\$1,400.00	\$840.00
\$1,400.00	\$840.00
\$1,225.00	\$765.00
\$1,075.00	\$635.00
\$1,075.00	\$635.00
\$755.00	\$400.00

Class 2

Set Range	Part #	Price
3 kg - 1 g	12147	\$3,850.00
5 kg - 1 mg	11930	\$5,325.00
5 kg - 1 mg*	114051	\$5,325.00
5 kg - 100 mg	45989	\$5,275.00
5 kg - 1 g	11933	\$4,875.00
5 kg - 1 g*	12146	\$4,875.00
5 kg - 100 g	45993	\$4,475.00

Optional Certificate

Accredited	Non-accredited
\$960.00	\$570.00
\$1,400.00	\$840.00
\$1,400.00	\$840.00
\$1,225.00	\$765.00
\$1,075.00	\$635.00
\$1,075.00	\$635.00
\$755.00	\$400.00

Class 3

Set Range	Part #	Price
3 kg - 1 g	12286	\$3,825.00
5 kg - 1 mg	12078	\$5,225.00
5 kg - 1 mg*	114052	\$5,225.00
5 kg - 100 mg	45990	\$5,075.00
5 kg - 1 g	12081	\$4,875.00
5 kg - 1 g*	12285	\$4,850.00
5 kg - 100 g	45994	\$4,450.00

Optional Certificate

Accredited	Non-accredited
\$960.00	\$570.00
\$1,400.00	\$840.00
\$1,400.00	\$840.00
\$1,225.00	\$765.00
\$1,075.00	\$635.00
\$1,075.00	\$635.00
\$755.00	\$400.00

Class 4

Set Range	Part #	Price
3 kg - 1 g	12389	\$3,425.00
5 kg - 1 mg	12224	\$4,725.00
5 kg - 1 mg*	114053	\$4,725.00
5 kg - 100 mg	45991	\$4,600.00
5 kg - 1 g	12227	\$4,200.00
5 kg - 1 g*	12388	\$4,200.00
5 kg - 100 g	45995	\$3,850.00

Optional Certificate

Accredited
\$445.00
\$780.00
\$780.00
\$590.00
\$490.00
\$490.00
\$300.00

* 5-2-2-1 configuration



PN 11887 Set Includes Lifting Device, Glove and Case (3kg to 1g)

Replacement Cases

Main Cases		
Class 0		
Set Range	Part #	Price
5 kg - 1 mg	49495	\$1,850.00
5 kg - 100 mg	49495	\$1,850.00
5 kg - 1 g	49495	\$1,850.00
5 kg - 100 g	50440	\$1,780.00

Main Case		
Class 1, 2 and 3		
Set Range	Part #	Price
3 kg - 1 g	11582	\$1,580.00
5 kg - 1 mg	11605	\$1,580.00
5 kg - 1 mg	11581	\$1,580.00
5 kg - 100 mg	11605	\$1,580.00
5 kg - 1 g	11605	\$1,580.00
5 kg - 1 g	11581	\$1,580.00
5 kg - 100 g	11605	\$1,580.00

Main Cases		
Class 4		
Set Range	Part #	Price
3 kg - 1 g	11582	\$1,580.00
5 kg - 1 mg	11605	\$1,580.00
5 kg - 1 mg	11581	\$1,580.00
5 kg - 100 mg	11605	\$1,580.00
5 kg - 1 g	11605	\$1,580.00
5 kg - 1 g	11581	\$1,580.00
5 kg - 100 g	11605	\$1,580.00

MASS REFERENCE STANDARDS / METRIC SETS
RANGE: 3 kg and 5 kg

ASTM
PRECISION

Weight Set Contents

			5-2-2-1				5-2-2-1				
3 kg - 1g		5 kg - 1mg		5 kg - 1mg		5 kg - 100 mg		5 kg - 1g		5 kg - 100 g	
–		45910 Class 0	–	114050 Class 1	45911 Class 0	45912 Class 0	–	45913 Class 0	–	45913 Class 0	
11887 Class 1		12481 Class 1	114051 Class 2	45988 Class 1	12484 Class 1	11933 Class 2	11886 Class 1	45992 Class 1	12146 Class 2	45993 Class 2	
12147 Class 2		11930 Class 2	114052 Class 3	45989 Class 2	11933 Class 2	12081 Class 3	12146 Class 2	45993 Class 2	12285 Class 3	45994 Class 3	
12286 Class 3		12078 Class 3	114053 Class 4	45990 Class 3	12081 Class 3	12227 Class 4	12285 Class 3	45994 Class 3	12388 Class 4	45995 Class 4	
12389 Class 4		12224 Class 4		45991 Class 4	12227 Class 4		12388 Class 4	45995 Class 4			
–	(1) 5 kg	(1) 5 kg	–	(1) 5 kg	(1) 5 kg	(1) 5 kg	(1) 5 kg	(1) 5 kg	–	(1) 5 kg	(1) 5 kg
(1) 3 kg	(1) 3 kg	–	(1) 3 kg	(1) 3 kg	(1) 3 kg	(1) 3 kg	–	(1) 3 kg	(1) 3 kg	(1) 3 kg	(1) 3 kg
(1) 2 kg	(1) 2 kg	(2) 2 kg	(1) 2 kg	(1) 2 kg	(1) 2 kg	(1) 2 kg	(2) 2 kg	(1) 2 kg	(1) 2 kg	(1) 2 kg	(1) 2 kg
(1) 1 kg	(1) 1 kg	(1) 1 kg	(1) 1 kg	(1) 1 kg	(1) 1 kg	(1) 1 kg	(1) 1 kg	(1) 1 kg	(1) 1 kg	(1) 1 kg	(1) 1 kg
(1) 500 g	(1) 500 g	(1) 500 g	(1) 500 g	(1) 500 g	(1) 500 g	(1) 500 g	(1) 500 g	(1) 500 g	(1) 500 g	(1) 500 g	(1) 500 g
(1) 300 g	(1) 300 g	–	(1) 300 g	(1) 300 g	(1) 300 g	(1) 300 g	–	(1) 300 g	–	(1) 300 g	(1) 300 g
(1) 200 g	(1) 200 g	(2) 200 g	(1) 200 g	(1) 200 g	(1) 200 g	(1) 200 g	(2) 200 g	(1) 200 g	(2) 200 g	(1) 200 g	(1) 200 g
(1) 100 g	(1) 100 g	(1) 100 g	(1) 100 g	(1) 100 g	(1) 100 g	(1) 100 g	(1) 100 g	(1) 100 g	(1) 100 g	(1) 100 g	(1) 100 g
(1) 50 g	(1) 50 g	(1) 50 g	(1) 50 g	(1) 50 g	(1) 50 g	(1) 50 g	(1) 50 g	(1) 50 g	(1) 50 g	(1) 50 g	(1) 50 g
(1) 30 g	(1) 30 g	–	(1) 30 g	(1) 30 g	(1) 30 g	(1) 30 g	–	(1) 30 g	–	(1) 30 g	(1) 30 g
(1) 20 g	(1) 20 g	(2) 20 g	(1) 20 g	(1) 20 g	(1) 20 g	(1) 20 g	(2) 20 g	(1) 20 g	(2) 20 g	(1) 20 g	(1) 20 g
(1) 10 g	(1) 10 g	(1) 10 g	(1) 10 g	(1) 10 g	(1) 10 g	(1) 10 g	(1) 10 g	(1) 10 g	(1) 10 g	(1) 10 g	(1) 10 g
(1) 5 g	(1) 5 g	(1) 5 g	(1) 5 g	(1) 5 g	(1) 5 g	(1) 5 g	(1) 5 g	(1) 5 g	(1) 5 g	(1) 5 g	(1) 5 g
(1) 3 g	(1) 3 g	–	(1) 3 g	(1) 3 g	(1) 3 g	(1) 3 g	–	(1) 3 g	–	(1) 3 g	(1) 3 g
(1) 2 g	(1) 2 g	(2) 2 g	(1) 2 g	(1) 2 g	(1) 2 g	(1) 2 g	(2) 2 g	(1) 2 g	(2) 2 g	(1) 2 g	(1) 2 g
(1) 1g	(1) 1g	(1) 1g	(1) 1g	(1) 1g	(1) 1g	(1) 1g	(1) 1g	(1) 1g	(1) 1g	(1) 1g	(1) 1g
	(1) 500 mg	(1) 500 mg	(1) 500 mg	(1) 500 mg	(1) 500 mg	(1) 500 mg		(1) 500 mg		(1) 500 mg	(1) 500 mg
	(1) 300 mg	–	(1) 300 mg	(1) 300 mg	(1) 300 mg	(1) 300 mg		(1) 300 mg		(1) 300 mg	(1) 300 mg
	(1) 200 mg	(2) 200 mg	(1) 200 mg	(1) 200 mg	(1) 200 mg	(1) 200 mg		(1) 200 mg		(1) 200 mg	(1) 200 mg
	(1) 100 mg	(1) 100 mg	(1) 100 mg	(1) 100 mg	(1) 100 mg	(1) 100 mg		(1) 100 mg		(1) 100 mg	(1) 100 mg
	(1) 50 mg	(1) 50 mg	(1) 50 mg	(1) 50 mg	(1) 50 mg	(1) 50 mg		(1) 50 mg		(1) 50 mg	(1) 50 mg
	(1) 30 mg	–	(1) 30 mg	(1) 30 mg	(1) 30 mg	(1) 30 mg		(1) 30 mg		(1) 30 mg	(1) 30 mg
	(1) 20 mg	(2) 20 mg	(1) 20 mg	(1) 20 mg	(1) 20 mg	(1) 20 mg		(1) 20 mg		(1) 20 mg	(1) 20 mg
	(1) 10 mg	(1) 10 mg	(1) 10 mg	(1) 10 mg	(1) 10 mg	(1) 10 mg		(1) 10 mg		(1) 10 mg	(1) 10 mg
	(1) 5 mg	(1) 5 mg	(1) 5 mg	(1) 5 mg	(1) 5 mg	(1) 5 mg		(1) 5 mg		(1) 5 mg	(1) 5 mg
	(1) 3 mg	–	(1) 3 mg	(1) 3 mg	(1) 3 mg	(1) 3 mg		(1) 3 mg		(1) 3 mg	(1) 3 mg
	(1) 2 mg	(2) 2 mg	(1) 2 mg	(1) 2 mg	(1) 2 mg	(1) 2 mg		(1) 2 mg		(1) 2 mg	(1) 2 mg
	(1) 1mg	(1) 1mg	(1) 1mg	(1) 1mg	(1) 1mg	(1) 1mg		(1) 1mg		(1) 1mg	(1) 1mg
15 pcs. 7.221kg set wt.	28 pcs. 12.222221kg set wt.	28 pcs. 12.23 kg set wt.	20 pcs. 12.22 kg set wt.	16 pcs. 12.221kg set wt.	16 pcs. 11.110 kg set wt.	8 pcs. 12.1kg set wt.					

OIML
PRECISION

BALANCE
CALIBRATION

STAINLESS
FIELD WEIGHTS

CAST IRON
FIELD WEIGHTS

ASTM
SPECIALTY

ACCESSORIES

Secondary Case		
Class 0		
Set Range	Part #	Price
100 g - 1mg	49503	\$250.00

Secondary Case		
Class 1, 2, 3 and 4		
Set Range	Part #	Price
100 g - 1mg	11588	\$180.00
100 g - 1mg	11596	\$180.00

Insert		
Wooden		
Set Range	Part #	Price
100 g	46380	\$120.00

Accessories

Description	Part #	Price
Statement of Accuracy	36092	\$47.50
Weight glove, white cotton	11714	\$6.75
Tweezer	11711	\$5.00
Premium tweezer	152414	\$43.00
Serial number	25836	\$17.00
Leaf weight cover	11755	\$43.00
Weight forceps, plastic	50035	\$43.00
Lifter bar	11747	\$21.00
Lifter bar, large handle	11712	\$73.00
Tong assembly, Class 0	50000	\$74.00
Lifter (Class 0 and OIML 2 kg and 5 kg)	50037	\$54.00

MASS REFERENCE STANDARDS / METRIC SETS

RANGE: 10 kg

Class 0

Statement of Accuracy not available.

Set Range	Part #	Price
10 kg - 1 mg	45905	\$14,975.00
10 kg - 100 mg	45906	\$14,200.00
10 kg - 1 g	45907	\$12,125.00
10 kg - 100 g	45908	\$12,025.00
10 kg - 1 kg	45909	\$9,475.00

Certificate

Accredited
Included
Included
Included
Included
Included

Class 1

Set Range	Part #	Price
10 kg - 1 mg	12485	\$8,500.00
10 kg - 100 mg	45996	\$8,375.00
10 kg - 1 g	12488	\$7,950.00
10 kg - 1 g*	11885	\$7,950.00
10 kg - 100 g	46000	\$7,875.00
10 kg - 1 kg	46004	\$6,455.00

Optional Certificate

Accredited	Non-accredited
\$1,500.00	\$900.00
\$1,325.00	\$820.00
\$1,180.00	\$690.00
\$1,180.00	\$690.00
\$870.00	\$440.00
\$530.00	\$280.00

Class 2

Set Range	Part #	Price
10 kg - 1 mg	11934	\$8,150.00
10 kg - 100 mg	45997	\$8,000.00
10 kg - 1 g	11937	\$7,925.00
10 kg - 1 g*	12144	\$7,875.00
10 kg - 100 g	46001	\$7,400.00
10 kg - 1 kg	46005	\$6,625.00

Optional Certificate

Accredited	Non-accredited
\$1,500.00	\$900.00
\$1,325.00	\$820.00
\$1,180.00	\$690.00
\$1,180.00	\$690.00
\$870.00	\$440.00
\$530.00	\$280.00

Class 3

Set Range	Part #	Price
10 kg - 1 mg	12082	\$8,075.00
10 kg - 100 mg	45998	\$7,900.00
10 kg - 1 g	12085	\$7,775.00
10 kg - 1 g*	12283	\$7,775.00
10 kg - 100 g	46002	\$7,300.00
10 kg - 1 kg	46006	\$6,550.00

Optional Certificate

Accredited	Non-accredited
\$1,500.00	\$900.00
\$1,325.00	\$820.00
\$1,180.00	\$690.00
\$1,180.00	\$690.00
\$870.00	\$440.00
\$530.00	\$280.00

Class 4

Set Range	Part #	Price
10 kg - 1 mg	12228	\$7,250.00
10 kg - 100 mg	45999	\$7,125.00
10 kg - 1 g	12231	\$7,025.00
10 kg - 1 g*	12386	\$7,025.00
10 kg - 100 g	46003	\$6,575.00
10 kg - 1 kg	46007	\$5,875.00

Optional Certificate

Accredited
\$830.00
\$640.00
\$535.00
\$535.00
\$350.00
\$250.00

* 5-2-2-1 configuration



PN 12485 Set Includes Lifting Device, Glove and Case (10 kg to 1 mg)

Replacement Cases

Main Cases		
Class 0		
Set Range	Part #	Price
10 kg - 1 mg	50442	\$2,160.00
10 kg - 100 mg	50442	\$2,160.00
10 kg - 1 g	50442	\$2,160.00
10 kg - 100 g	50442	\$2,160.00
10 kg - 1 kg	50441	\$1,820.00

Main Case		
Class 1, 2 and 3		
Set Range	Part #	Price
10 kg - 1 mg	11606	\$2,130.00
10 kg - 100 mg	11606	\$2,130.00
10 kg - 1 g	11606	\$2,130.00
10 kg - 1 g	11580	\$2,130.00
10 kg - 100 g	11606	\$2,130.00
10 kg - 1 kg	11606	\$2,130.00

Main Cases		
Class 4		
Set Range	Part #	Price
10 kg - 1 mg	11606	\$2,130.00
10 kg - 100 mg	11606	\$2,130.00
10 kg - 1 g	11606	\$2,130.00
10 kg - 1 g	11580	\$2,130.00
10 kg - 100 g	11606	\$2,130.00
10 kg - 1 kg	11606	\$2,130.00

RANGE: 10 kg

ASTM
PRECISION

Weight Set Contents

5-2-2-1

10 kg - 1mg	10 kg - 100 mg	10 kg - 1g	10 kg - 1g	10 kg - 100 g	10 kg - 1 kg
45905 Class 0 12485 Class 1 11934 Class 2 12082 Class 3 12278 Class 4	45906 Class 0 45996 Class 1 45997 Class 2 45998 Class 3 45999 Class 4	45907 Class 0 12488 Class 1 11937 Class 2 12085 Class 3 12231 Class 4	11885 Class 1 12144 Class 2 12283 Class 3 12386 Class 4 -	45908 Class 0 46000 Class 1 46001 Class 2 46002 Class 3 46003 Class 4	45909 Class 0 46004 Class 1 46005 Class 2 46006 Class 3 46007 Class 4
(1) 10 kg (1) 5 kg (1) 3 kg (1) 2 kg (1) 1 kg (1) 500 g (1) 300 g (1) 200 g (1) 100 g (1) 50 g (1) 30 g (1) 20 g (1) 10 g (1) 5 g (1) 3 g (1) 2 g (1) 1 g (1) 500 mg (1) 300 mg (1) 200 mg (1) 100 mg (1) 50 mg (1) 30 mg (1) 20 mg (1) 10 mg (1) 5 mg (1) 3 mg (1) 2 mg (1) 1 mg	(1) 10 kg (1) 5 kg (1) 3 kg (1) 2 kg (1) 1 kg (1) 500 g (1) 300 g (1) 200 g (1) 100 g (1) 50 g (1) 30 g (1) 20 g (1) 10 g (1) 5 g (1) 3 g (1) 2 g (1) 1 g (1) 500 mg (1) 300 mg (1) 200 mg (1) 100 mg	(1) 10 kg (1) 5 kg (1) 3 kg (1) 2 kg (1) 1 kg (1) 500 g (1) 300 g (1) 200 g (1) 100 g (1) 50 g (1) 30 g (1) 20 g (1) 10 g (1) 5 g (1) 3 g (1) 2 g (1) 1 g	(1) 10 kg (1) 5 kg - (2) 2 kg (1) 1 kg (1) 500 g - (2) 200 g (1) 100 g (1) 50 g - (2) 20 g (1) 10 g (1) 5 g - (2) 2 g (1) 1 g	(1) 10 kg (1) 5 kg (1) 3 kg (1) 2 kg (1) 1 kg (1) 500 g (1) 300 g (1) 200 g (1) 100 g	(1) 10 kg (1) 5 kg (1) 3 kg (1) 2 kg (1) 1 kg
29 pcs. 22.222221 kg set wt.	21 pcs. 22.2221 kg set wt.	17 pcs. 22.221 kg set wt.	17 pcs. 21.11 kg set wt.	9 pcs. 22.1 kg set wt.	5 pcs. 21 kg set wt.

OIML
PRECISION

BALANCE
CALIBRATION

STAINLESS
FIELD WEIGHTS

CAST IRON
FIELD WEIGHTS

ASTM
SPECIALTY

ACCESSORIES

Accessories

Secondary Case		
Class 0		
Set Range	Part #	Price
100 g - 1mg*	11588	\$180.00
100 g - 1 mg	49503	\$250.00
Insert, 100 g	49489	\$160.00

Secondary Case		
Class 1, 2, 3 and 4		
Set Range	Part #	Price
100 g - 1mg*	11588	\$180.00
100 g - 1 mg	11596	\$180.00
Insert, 100 g	46380	\$120.00

Description	Part #	Price
Statement of Accuracy	36092	\$47.50
Weight glove, white cotton	11714	\$6.75
Tweezer	11711	\$5.00
Premium tweezer	152414	\$43.00
Serial number	25836	\$17.00
Leaf weight cover	11755	\$43.00
Weight forceps, plastic	50035	\$43.00
Lifter bar	11747	\$21.00
Lifter bar, large handle	11712	\$73.00
Tong assembly, Class 0	50000	\$74.00
Lifter (Class 0 and OIML 2 kg and 5 kg)	50037	\$54.00

MASS REFERENCE STANDARDS / METRIC SETS

RANGE: 20 kg and 25 kg

Class 0

Statement of Accuracy not available.

Set Range	Part #	Price
20 kg - 1 mg	45900	\$18,950.00
20 kg - 100 mg	45901	\$18,225.00
20 kg - 1 g	45902	\$16,125.00
20 kg - 100 g	45903	\$16,025.00
20 kg - 1 kg	45904	\$13,925.00

Certificate

Accredited
Included
Included
Included
Included
Included

Class 1

Set Range	Part #	Price
25 kg - 1 g*	11883	\$15,950.00
20 kg - 1 mg	12489	\$11,700.00
20 kg - 100 mg	46008	\$11,575.00
20 kg - 1 g	12492	\$10,850.00
20 kg - 1 g*	11884	\$10,850.00
20 kg - 100 g	46012	\$10,250.00
20 kg - 1 kg	46016	\$10,050.00

Optional Certificate

Accredited	Non-accredited
\$1,395.00	\$815.00
\$1,680.00	\$1,025.00
\$1,445.00	\$885.00
\$1,285.00	\$760.00
\$1,285.00	\$760.00
\$975.00	\$500.00
\$645.00	\$340.00

Class 2

Set Range	Part #	Price
25 kg - 1 g*	12140	\$14,375.00
20 kg - 1 mg	11938	\$10,625.00
20 kg - 100 mg	46009	\$10,450.00
20 kg - 1 g	11941	\$10,350.00
20 kg - 1 g*	12142	\$10,350.00
20 kg - 100 g	46013	\$9,850.00
20 kg - 1 kg	46017	\$9,075.00

Optional Certificate

Accredited	Non-accredited
\$1,395.00	\$815.00
\$1,680.00	\$1,025.00
\$1,445.00	\$885.00
\$1,285.00	\$760.00
\$1,285.00	\$760.00
\$975.00	\$500.00
\$645.00	\$340.00

Class 3

Set Range	Part #	Price
25 kg - 1 g*	12279	\$13,825.00
20 kg - 1 mg	12086	\$10,525.00
20 kg - 100 mg	46010	\$10,350.00
20 kg - 1 g	12089	\$10,225.00
20 kg - 1 g*	12281	\$10,225.00
20 kg - 100 g	46014	\$9,725.00
20 kg - 1 kg	46018	\$8,775.00

Optional Certificate

Accredited	Non-accredited
\$1,395.00	\$815.00
\$1,680.00	\$1,025.00
\$1,445.00	\$885.00
\$1,285.00	\$760.00
\$1,285.00	\$760.00
\$975.00	\$500.00
\$645.00	\$340.00

Class 4

Set Range	Part #	Price
25 kg - 1 g*	12382	\$12,925.00
20 kg - 1 mg	12232	\$9,475.00
20 kg - 100 mg	46011	\$9,300.00
20 kg - 1 g	12235	\$9,225.00
20 kg - 1 g*	12384	\$9,225.00
20 kg - 100 g	46015	\$8,775.00
20 kg - 1 kg	46019	\$8,075.00

Optional Certificate

Accredited
\$590.00
\$900.00
\$680.00
\$610.00
\$610.00
\$395.00
\$270.00

* 5-2-2-1 configuration

Replacement Cases

Main Cases		
Class 0		
Set Range	Part #	Price
20 kg - 1 mg	50670	\$2,160.00
20 kg - 100 mg	50670	\$2,160.00
20 kg - 1 g	50670	\$2,160.00
20 kg - 100 g	50670	\$2,160.00
20 kg - 1 kg	50670	\$2,160.00

Main Case		
Class 1, 2 and 3		
Set Range	Part #	Price
25 kg - 1 g*	11578	\$2,130.00
20 kg - 1 mg	11608	\$2,130.00
20 kg - 100 mg	11608	\$2,130.00
20 kg - 1 g	11608	\$2,130.00
20 kg - 1 g*	11579	\$2,080.00
20 kg - 100 g	11608	\$2,130.00
20 kg - 1 kg	11608	\$2,130.00

Main Cases		
Class 4		
Set Range	Part #	Price
25 kg - 1 g*	11578	\$2,130.00
20 kg - 1 mg	11608	\$2,130.00
20 kg - 100 mg	11608	\$2,130.00
20 kg - 1 g	11579	\$2,080.00
20 kg - 1 g*	11608	\$2,130.00
20 kg - 100 g	11608	\$2,130.00
20 kg - 1 kg	11608	\$2,130.00

MASS REFERENCE STANDARDS / METRIC SETS

RANGE: 20 kg and 25 kg

ASTM
PRECISION

Weight Set Contents

5-2-2-1			5-2-2-1				
25 kg - 1g		20 kg - 1mg	20 kg - 100 mg	20 kg - 1g	20 kg - 1g	20 kg - 100 g	20 - 1kg
–		45900 Class 0	45901 Class 0	45902 Class 0	–	45903 Class 0	45904 Class 0
11883 Class 1		12489 Class 1	46008 Class 1	12492 Class 1	11884 Class 1	46012 Class 1	46016 Class 1
12140 Class 2		11938 Class 2	46009 Class 2	11941 Class 2	12142 Class 2	46013 Class 2	46017 Class 2
12279 Class 3		12086 Class 3	46010 Class 3	12089 Class 3	12281 Class 3	46014 Class 3	46018 Class 3
12382 Class 4		12232 Class 4	46011 Class 4	12235 Class 4	12384 Class 4	46015 Class 4	46019 Class 4
(1) 25 kg	–	–	–	–	–	–	–
–	(1) 20 kg	(1) 20 kg	(1) 20 kg	(1) 20 kg	(1) 20 kg	(1) 20 kg	(1) 20 kg
(1) 10 kg	(1) 10 kg	(1) 10 kg	(1) 10 kg	(1) 10 kg	(1) 10 kg	(1) 10 kg	(1) 10 kg
(1) 5 kg	(1) 5 kg	(1) 5 kg	(1) 5 kg	(1) 5 kg	(1) 5 kg	(1) 5 kg	(1) 5 kg
–	(1) 3 kg	(1) 3 kg	(1) 3 kg	(1) 3 kg	–	(1) 3 kg	(1) 3 kg
(2) 2 kg	(1) 2 kg	(1) 2 kg	(1) 2 kg	(1) 2 kg	(2) 2 kg	(1) 2 kg	(1) 2 kg
(1) 1 kg	(1) 1 kg	(1) 1 kg	(1) 1 kg	(1) 1 kg	(1) 1 kg	(1) 1 kg	(1) 1 kg
(1) 500 g	(1) 500 g	(1) 500 g	(1) 500 g	(1) 500 g	(1) 500 g	(1) 500 g	
–	(1) 300 g	(1) 300 g	(1) 300 g	(1) 300 g	–	(1) 300 g	
(2) 200 g	(1) 200 g	(1) 200 g	(1) 200 g	(1) 200 g	(2) 200 g	(1) 200 g	
(1) 100 g	(1) 100 g	(1) 100 g	(1) 100 g	(1) 100 g	(1) 100 g	(1) 100 g	
(1) 50 g	(1) 50 g	(1) 50 g	(1) 50 g	(1) 50 g	(1) 50 g		
–	(1) 30 g	(1) 30 g	(1) 30 g	(1) 30 g	–		
(2) 20 g	(1) 20 g	(1) 20 g	(1) 20 g	(1) 20 g	(2) 20 g		
(1) 10 g	(1) 10 g	(1) 10 g	(1) 10 g	(1) 10 g	(1) 10 g		
(1) 5 g	(1) 5 g	(1) 5 g	(1) 5 g	(1) 5 g	(1) 5 g		
–	(1) 3 g	(1) 3 g	(1) 3 g	(1) 3 g	–		
(2) 2 g	(1) 2 g	(1) 2 g	(1) 2 g	(1) 2 g	(2) 2 g		
(1) 1 g	(1) 1 g	(1) 1 g	(1) 1 g	(1) 1 g	(1) 1 g		
	(1) 500 mg	(1) 500 mg					
	(1) 300 mg	(1) 300 mg					
	(1) 200 mg	(1) 200 mg					
	(1) 100 mg	(1) 100 mg					
	(1) 50 mg						
	(1) 30 mg						
	(1) 20 mg						
	(1) 10 mg						
	(1) 5 mg						
	(1) 3 mg						
	(1) 2 mg						
	(1) 1 mg						
18 pcs. 46.11kg set wt.	30 pcs. 42.222221kg set wt.	22 pcs. 42.22kg set wt.	18 pcs. 42.22 kg set wt.	18 pcs. 41.11kg set wt.	10 pcs. 42.1kg set wt.	6 pcs. 41kg set wt.	

OIML
PRECISION

BALANCE
CALIBRATION

STAINLESS
FIELD WEIGHTS

CAST IRON
FIELD WEIGHTS

ASTM
SPECIALTY

ACCESSORIES

Accessories

Secondary Case		
Class 0		
Set Range	Part #	Price
100 g - 1mg*	11588	\$180.00
100 g - 1mg	49503	\$250.00
Insert, 100 g	49489	\$160.00

Secondary Case		
Class 1, 2, 3 and 4		
Set Range	Part #	Price
100 g - 1mg*	11588	\$180.00
100 g - 1mg	11596	\$180.00
Insert, 100 g	46380	\$120.00

Description	Part #	Price
Statement of Accuracy	36092	\$47.50
Weight glove, white cotton	11714	\$6.75
Tweezer	11711	\$5.00
Premium tweezer	152414	\$43.00
Serial number	25836	\$17.00
Leaf weight cover	11755	\$43.00
Weight forceps, plastic	50035	\$43.00
Lifter bar	11747	\$21.00
Lifter bar, large handle	11712	\$73.00
Tong assembly, Class 0	50000	\$74.00
Lifter (Class 0 and OIML 2 kg and 5 kg)	50037	\$54.00

* 5-2-2-1 configuration

MASS REFERENCE STANDARDS / METRIC SETS

RANGE: 2 lb through 50 lb

Class 1

Set Range	Part #	Price
50 lb - 1/32 oz	11999	\$20,825.00
50 lb - 0.001lb	119043	\$20,825.00
20 lb - 1/32 oz	11997	\$9,975.00
20 lb - 0.001lb	119047	\$9,975.00
10 lb - 1/32 oz	11995	\$6,975.00
10 lb - 0.001lb	119051	\$6,975.00
5 lb - 1/32 oz	11993	\$5,325.00
5 lb - 0.001lb	119055	\$5,325.00
2 lb - 1/32 oz	11991	\$3,550.00
2 lb - 0.001lb	119059	\$3,550.00

Optional Certificate

Accredited	Non-accredited
\$1,260.00	\$800.00
\$1,260.00	\$800.00
\$950.00	\$670.00
\$950.00	\$670.00
\$830.00	\$600.00
\$830.00	\$600.00
\$725.00	\$530.00
\$725.00	\$530.00
\$545.00	\$415.00
\$545.00	\$415.00

Class 2

Set Range	Part #	Price
50 lb - 1/32 oz	12145	\$20,600.00
50 lb - 0.001lb	119044	\$20,600.00
20 lb - 1/32 oz	12143	\$9,975.00
20 lb - 0.001lb	119048	\$9,975.00
10 lb - 1/32 oz	12141	\$6,975.00
10 lb - 0.001lb	119052	\$6,775.00
5 lb - 1/32 oz	12139	\$5,125.00
5 lb - 0.001lb	119056	\$5,125.00
2 lb - 1/32 oz	12137	\$3,400.00
2 lb - 0.001lb	119060	\$3,400.00

Optional Certificate

Accredited	Non-accredited
\$1,260.00	\$800.00
\$1,260.00	\$800.00
\$950.00	\$670.00
\$950.00	\$670.00
\$830.00	\$600.00
\$830.00	\$600.00
\$725.00	\$530.00
\$725.00	\$530.00
\$545.00	\$415.00
\$545.00	\$415.00

Class 3

Set Range	Part #	Price
50 lb - 1/32 oz	12284	\$20,325.00
50 lb - 0.001lb	119045	\$20,325.00
20 lb - 1/32 oz	12282	\$9,750.00
20 lb - 0.001lb	119049	\$9,950.00
10 lb - 1/32 oz	12280	\$6,675.00
10 lb - 0.001lb	119053	\$6,675.00
5 lb - 1/32 oz	12278	\$5,075.00
5 lb - 0.001lb	119057	\$5,075.00
2 lb - 1/32 oz	12276	\$3,225.00
2 lb - 0.001lb	119061	\$3,225.00

Optional Certificate

Accredited	Non-accredited
\$1,260.00	\$800.00
\$1,260.00	\$800.00
\$950.00	\$670.00
\$950.00	\$670.00
\$830.00	\$600.00
\$830.00	\$600.00
\$725.00	\$530.00
\$725.00	\$530.00
\$545.00	\$415.00
\$545.00	\$415.00

Class 4

Set Range	Part #	Price
50 lb - 1/32 oz	12387	\$19,825.00
50 lb - 0.001lb	119046	\$19,825.00
20 lb - 1/32 oz	12385	\$9,150.00
20 lb - 0.001lb	119050	\$9,150.00
10 lb - 1/32 oz	12383	\$6,575.00
10 lb - 0.001lb	119054	\$6,575.00
5 lb - 1/32 oz	12381	\$4,575.00
5 lb - 0.001lb	119058	\$4,575.00
2 lb - 1/32 oz	12379	\$2,975.00
2 lb - 0.001lb	119062	\$2,975.00

Optional Certificate

Accredited
\$605.00
\$605.00
\$500.00
\$500.00
\$465.00
\$465.00
\$410.00
\$410.00
\$325.00
\$325.00



PN 11995 Set Includes Lifting Device, Glove and Case (10 lb to 1/32 oz)

Weight Set Contents

50 lb - 1/32 oz	50 lb - 0.001lb	20 lb - 1/32 oz	20 lb - 0.001lb	10 lb - 1/32 oz	10 lb - 0.001lb	5 lb - 1/32 oz	5 lb - 0.001lb	2 lb - 1/32 oz	2 lb - 0.001lb
11999 Class 1	119043 Class 1	11997 Class 1	119047 Class 1	11995 Class 1	119051 Class 1	11993 Class 1	119055 Class 1	11991 Class 1	119059 Class 1
12145 Class 2	119044 Class 2	12143 Class 2	119048 Class 2	12141 Class 2	119052 Class 2	12139 Class 2	119056 Class 2	12137 Class 2	119060 Class 2
12284 Class 3	119045 Class 3	12282 Class 3	119049 Class 3	12280 Class 3	119053 Class 3	12278 Class 3	119057 Class 3	12276 Class 3	119061 Class 3
12387 Class 4	119046 Class 4	12385 Class 4	119050 Class 4	12383 Class 4	119054 Class 4	12381 Class 4	119058 Class 4	12379 Class 4	119062 Class 4
(1) 50 lb	(1) 50 lb	—	—	—	—	—	—	—	—
(1) 30 lb	(1) 30 lb	—	—	—	—	—	—	—	—
(1) 20 lb	(1) 20 lb	(1) 20 lb	(1) 20 lb	—	—	—	—	—	—
(1) 10 lb	(1) 10 lb	(1) 10 lb	(1) 10 lb	(1) 10 lb	(1) 10 lb	—	—	—	—
(1) 5 lb	(1) 5 lb	(1) 5 lb	(1) 5 lb	(1) 5 lb	(1) 5 lb	(1) 5 lb	(1) 5 lb	—	—
(1) 3 lb	(1) 3 lb	(1) 3 lb	(1) 3 lb	(1) 3 lb	(1) 3 lb	(1) 3 lb	(1) 3 lb	—	—
(1) 2 lb	(1) 2 lb	(1) 2 lb	(1) 2 lb	(1) 2 lb	(1) 2 lb	(1) 2 lb	(1) 2 lb	(1) 2 lb	(1) 2 lb
(1) 1 lb	(1) 1 lb	(1) 1 lb	(1) 1 lb	(1) 1 lb	(1) 1 lb	(1) 1 lb	(1) 1 lb	(1) 1 lb	(1) 1 lb
(1) 8 oz	(1) 0.5 lb	(1) 8 oz	(1) 0.5 lb	(1) 8 oz	(1) 0.5 lb	(1) 8 oz	(1) 0.5 lb	(1) 8 oz	(1) 0.5 lb
(1) 4 oz	(1) 0.3 lb	(1) 4 oz	(1) 0.3 lb	(1) 4 oz	(1) 0.3 lb	(1) 4 oz	(1) 0.3 lb	(1) 4 oz	(1) 0.3 lb
(1) 2 oz	(1) 0.2 lb	(1) 2 oz	(1) 0.2 lb	(1) 2 oz	(1) 0.2 lb	(1) 2 oz	(1) 0.2 lb	(1) 2 oz	(1) 0.2 lb
(1) 1 oz	(1) 0.1 lb	(1) 1 oz	(1) 0.1 lb	(1) 1 oz	(1) 0.1 lb	(1) 1 oz	(1) 0.1 lb	(1) 1 oz	(1) 0.1 lb
(1) 1/2 oz	(1) 0.05 lb	(1) 1/2 oz	(1) 0.05 lb	(1) 1/2 oz	(1) 0.05 lb	(1) 1/2 oz	(1) 0.05 lb	(1) 1/2 oz	(1) 0.05 lb
(1) 1/4 oz	(1) 0.03 lb	(1) 1/4 oz	(1) 0.03 lb	(1) 1/4 oz	(1) 0.03 lb	(1) 1/4 oz	(1) 0.03 lb	(1) 1/4 oz	(1) 0.03 lb
(1) 1/8 oz	(1) 0.02 lb	(1) 1/8 oz	(1) 0.02 lb	(1) 1/8 oz	(1) 0.02 lb	(1) 1/8 oz	(1) 0.02 lb	(1) 1/8 oz	(1) 0.02 lb
(1) 1/16 oz	(1) 0.01 lb	(1) 1/16 oz	(1) 0.01 lb	(1) 1/16 oz	(1) 0.01 lb	(1) 1/16 oz	(1) 0.01 lb	(1) 1/16 oz	(1) 0.01 lb
(2) 1/32 oz	(1) 0.005 lb	(2) 1/32 oz	(1) 0.005 lb	(2) 1/32 oz	(1) 0.005 lb	(2) 1/32 oz	(1) 0.005 lb	(2) 1/32 oz	(1) 0.005 lb
	(1) 0.003 lb		(1) 0.003 lb		(1) 0.003 lb		(1) 0.003 lb		(1) 0.003 lb
	(1) 0.002 lb		(1) 0.002 lb		(1) 0.002 lb		(1) 0.002 lb		(1) 0.002 lb
	(1) 0.001 lb		(1) 0.001 lb		(1) 0.001 lb		(1) 0.001 lb		(1) 0.001 lb
18 pcs. 122 lb set wt.	20 pcs. 122 lb set wt.	16 pcs. 42 lb set wt.	18 pcs. 42 lb set wt.	15 pcs. 22 lb set wt.	17 pcs. 22 lb set wt.	14 pcs. 12 lb set wt.	16 pcs. 12 lb set wt.	12 pcs. 4 lb set wt.	14 pcs. 4 lb set wt.

Replacement Cases

Main Cases		
Class 1, 2 and 3		
Set Range	Part #	Price
50 lb - 1/32 oz	11589	\$2,130.00
50 lb - 0.001lb	11589	\$2,130.00
20 lb - 1/32 oz	11590	\$2,280.00
20 lb - 0.001lb	11590	\$2,280.00
10 lb - 1/32 oz	11591	\$1,820.00
10 lb - 0.001lb	11591	\$1,820.00
5 lb - 1/32 oz	11592	\$1,410.00
5 lb - 0.001lb	11592	\$1,410.00
2 lb - 1/32 oz	11593	\$1,840.00
2 lb - 0.001lb	11593	\$1,840.00

Main Cases		
Class 4		
Set Range	Part #	Price
50 lb - 1/32 oz	11589	\$2,130.00
50 lb - 0.001lb	11589	\$2,130.00
20 lb - 1/32 oz	11590	\$2,280.00
20 lb - 0.001lb	11590	\$2,280.00
10 lb - 1/32 oz	11591	\$1,820.00
10 lb - 0.001lb	11591	\$1,820.00
5 lb - 1/32 oz	11592	\$1,410.00
5 lb - 0.001lb	11592	\$1,410.00
2 lb - 1/32 oz	11593	\$1,840.00
2 lb - 0.001lb	11593	\$1,840.00

Secondary Case		
Class 1, 2, 3 and 4		
Set Range	Part #	Price
4 oz - 1/32 oz	11610	\$310.00
0.3 lb to 0.001 lb	118813	\$295.00

Accessories

Description	Part #	Price
Statement of Accuracy	36092	\$47.50
Weight glove, white cotton	11714	\$6.75
Tweezer	11711	\$5.00
Premium tweezer	152414	\$43.00
Serial number	25836	\$17.00
Leaf weight cover	11755	\$43.00
Weight forceps, plastic	50035	\$43.00
Lifter bar	11747	\$21.00
Lifter bar, large handle	11712	\$73.00
Tong assembly, Class 0	50000	\$74.00
Lifter (Class 0 and OIML 2 kg and 5 kg)	50037	\$54.00

OIML

Mass Reference Standards

Applications:

Density measurement

Tolerance checking

Mass standards

OIML guidelines for balance and scale verification

Designs Available:

Type I (one piece design) for Class E1, E2

Type II (with sealing cavity) for Class F1, F2, M1, M2

Product Configuration:

Single weight

Single weight kit: weight, case or vial, and glove

Weight set: weights, case (additional small case or vial if required) and handling equipment

Weight set configuration: 5-2-2-1 Example: (1) 50 g, (2) 20 g and (1) 10 g

OIML weight sets larger than 500 g include a hardwood case with velvet-lined pockets

Weight sets with the largest weight of 500 g include a precision-machined, polyvinyl, crush-resistant case

Features:

Serial numbers applied to case (weights may be marked with symbol)

Density for E1/E2 are 7.95 g/cm³

Density for F1/F2/M1/M2 are 7.84 g/cm³ (unless otherwise noted)

OIML E1, E2, F1 and F2 polish finish

OIML M1 and M2 satin finish

E1, E2, F1, F2 and M1 weights include protective case

Weights manufactured to International Recommendation, OIML R111 specifications

E1 and E2 supplied with Accredited Certificate per OIML R111



Metric Single Weight with Case (Kits)

- 62** Range: 10 kg – 1g
- 63** Range: 500 mg – 1mg

Metric Single Weights

- 64** Range: 20 kg – 1mg

Metric Sets

- 65** Range: 500 mg – 50 g
- 66** Range: 100 g
- 68** Range: 200 g
- 70** Range: 500 g
- 72** Range: 1 kg
- 74** Range: 2 kg
- 76** Range: 5 kg
- 78** Range: 10 kg
- 80** Range: 20 kg

MASS REFERENCE STANDARDS / METRIC SINGLE WEIGHT WITH CASE (KITS)

RANGE: 10 kg – 1 g

Class E1 Polished Finish

Statement of Accuracy not available.

Weight	Part #	Price	Certificate Accredited
10 kg	36872	\$3,625.00	Included
5 kg	29785	\$2,400.00	Included
2 kg	29784	\$1,720.00	Included
1 kg	29783	\$1,160.00	Included
500 g	29782	\$860.00	Included
200 g	29781	\$740.00	Included
100 g	29780	\$690.00	Included
50 g	29779	\$615.00	Included
20 g	29778	\$610.00	Included
10 g	29777	\$605.00	Included
5 g	29776	\$545.00	Included
2 g	29745	\$545.00	Included
1 g	29744	\$520.00	Included

Class E2 Polished Finish

Statement of Accuracy not available.

Weight	Part #	Price	Certificate Accredited
20 kg	53850	\$3,250.00	Included
10 kg	36871	\$2,675.00	Included
5 kg	29775	\$1,500.00	Included
2 kg	29774	\$945.00	Included
1 kg	29773	\$705.00	Included
500 g	29772	\$490.00	Included
200 g	29771	\$390.00	Included
100 g	29770	\$190.00	Included
50 g	29769	\$185.00	Included
20 g	29768	\$185.00	Included
10 g	29767	\$175.00	Included
5 g	29766	\$150.00	Included
2 g	29743	\$150.00	Included
1 g	29742	\$150.00	Included

Class F1 Polished Finish

Weight	Part #	Price	Optional Certificate Accredited	Optional Certificate Non-accredited
20 kg	53654	\$2,400.00	\$145.00	\$80.00
10 kg	36870	\$1,940.00	\$145.00	\$80.00
5 kg	29765	\$1,170.00	\$145.00	\$80.00
2 kg	29764	\$685.00	\$145.00	\$80.00
1 kg	29763	\$485.00	\$125.00	\$60.00
500 g	29762	\$280.00	\$125.00	\$60.00
200 g	29761	\$220.00	\$125.00	\$60.00
100 g	29760	\$155.00	\$55.00	\$45.00
50 g	29759	\$135.00	\$55.00	\$45.00
20 g	29758	\$135.00	\$55.00	\$45.00
10 g	29757	\$135.00	\$55.00	\$45.00
5 g	29756	\$135.00	\$55.00	\$45.00
2 g	29741	\$135.00	\$55.00	\$45.00
1 g	29740	\$135.00	\$55.00	\$45.00

Class F2 Polished Finish

Weight	Part #	Price	Optional Certificate Accredited	Optional Certificate Non-accredited
20 kg	53655	\$2,290.00	\$145.00	\$80.00
10 kg	36869	\$1,500.00	\$145.00	\$80.00
5 kg	29755	\$815.00	\$145.00	\$80.00
2 kg	29754	\$645.00	\$145.00	\$80.00
1 kg	29753	\$415.00	\$125.00	\$60.00
500 g	29752	\$280.00	\$125.00	\$60.00
200 g	29751	\$215.00	\$125.00	\$60.00
100 g	29750	\$130.00	\$55.00	\$45.00
50 g	29749	\$130.00	\$55.00	\$45.00
20 g	29748	\$130.00	\$55.00	\$45.00
10 g	29747	\$93.00	\$55.00	\$45.00
5 g	29746	\$130.00	\$55.00	\$45.00
2 g	29739	\$130.00	\$55.00	\$45.00
1 g	29738	\$130.00	\$55.00	\$45.00



PN 29780 Kits Include Glove with Cased Weight

Accessories

Description	Part #	Price
Statement of Accuracy	36092	\$47.50
Weight glove, white cotton	11714	\$6.75
Premium tweezers	152414	\$43.00

MASS REFERENCE STANDARDS / METRIC SINGLE WEIGHT WITH CASE (KITS)

RANGE: 500 mg – 1 mg

Class E1 Polished Finish
Statement of Accuracy not available.

Weight	Part #	Price
500 mg	29737	\$295.00
200 mg	29736	\$295.00
100 mg	29735	\$295.00
50 mg	29734	\$295.00
20 mg	29733	\$295.00
10 mg	29732	\$295.00
5 mg	29713	\$295.00
2 mg	29712	\$295.00
1 mg	29711	\$295.00

Certificate

Accredited
Included
Included
Included
Included
Included
Included
Included
Included
Included
Included

Class F2 Polished Finish

Weight	Part #	Price
500 mg	29719	\$48.50
200 mg	29718	\$48.50
100 mg	29717	\$48.50
50 mg	29716	\$48.50
20 mg	29715	\$48.50
10 mg	29714	\$48.50
5 mg	29704	\$48.50
2 mg	29703	\$48.50
1 mg	29702	\$48.50

Optional Certificate

Accredited	Accredited
\$55.00	\$45.00
\$55.00	\$45.00
\$55.00	\$45.00
\$55.00	\$45.00
\$55.00	\$45.00
\$55.00	\$45.00
\$55.00	\$45.00
\$55.00	\$45.00
\$55.00	\$45.00
\$55.00	\$45.00

Class E2 Polished Finish
Statement of Accuracy not available.

Weight	Part #	Price
500 mg	29731	\$150.00
200 mg	29730	\$150.00
100 mg	29729	\$150.00
50 mg	29728	\$150.00
20 mg	29727	\$150.00
10 mg	29726	\$150.00
5 mg	29710	\$150.00
2 mg	29709	\$150.00
1 mg	29708	\$150.00

Certificate

Accredited
Included
Included
Included
Included
Included
Included
Included
Included
Included

Class F1 Polished Finish

Weight	Part #	Price
500 mg	29725	\$54.00
200 mg	29724	\$54.00
100 mg	29723	\$54.00
50 mg	29722	\$54.00
20 mg	29721	\$54.00
10 mg	29720	\$54.00
5 mg	29707	\$54.00
2 mg	29706	\$54.00
1 mg	29705	\$54.00

Optional Certificate

Accredited	Non-Accredited
\$55.00	\$45.00
\$55.00	\$45.00
\$55.00	\$45.00
\$55.00	\$45.00
\$55.00	\$45.00
\$55.00	\$45.00
\$55.00	\$45.00
\$55.00	\$45.00
\$55.00	\$45.00



Accessories

Description	Part #	Price
Statement of Accuracy	36092	\$47.50
Weight glove, white cotton	11714	\$6.75
Premium tweezer	152414	\$43.00
Vial for mg weights	50038	\$5.00

ASTM
PRECISION

OIML
PRECISION

BALANCE
CALIBRATION

STAINLESS
FIELD WEIGHTS

CAST IRON
FIELD WEIGHTS

ASTM
SPECIALTY

ACCESSORIES

MASS REFERENCE STANDARDS / METRIC SINGLE WEIGHTS

RANGE: 20 kg – 1 mg

ASTM
PRECISION

OIML
PRECISION

BALANCE
CALIBRATION

STAINLESS
FIELD WEIGHTS

CAST IRON
FIELD WEIGHTS

ASTM
SPECIALTY

ACCESSORIES

Class M1 Satin Finish

Weight	Part #	Price	Accredited
20 kg	156292	\$1,450.00	\$75.00
10 kg	156291	\$1,240.00	\$75.00
5 kg	116207	\$565.00	\$75.00
2 kg	116206	\$320.00	\$75.00
1 kg	116205	\$225.00	\$55.00
500 g	116204	\$130.00	\$55.00
200 g	116203	\$115.00	\$55.00
100 g	111927	\$87.00	\$40.00
50 g	111928	\$82.00	\$40.00
20 g	111929	\$79.00	\$40.00
10 g	111930	\$79.00	\$40.00
5 g	111931	\$73.00	\$40.00
2 g	111932	\$73.00	\$40.00
1 g	111933	\$73.00	\$40.00
500 mg	202833	\$24.25	\$40.00
200 mg	202835	\$24.25	\$40.00
100 mg	202836	\$24.25	\$40.00
50 mg	202837	\$24.25	\$40.00
20 mg	202838	\$24.25	\$40.00
10 mg	202839	\$24.25	\$40.00
5 mg	202840	\$24.25	\$40.00
2 mg	202841	\$24.25	\$40.00
1 mg	202842	\$24.25	\$40.00

Optional Certificate

Class M2 Satin Finish

M2 is sold as a single weight, accessory cases are available.

Weight	Part #	Price	Accredited
5 kg	115926	\$240.00	\$75.00
2 kg	115925	\$150.00	\$75.00
1 kg	115924	\$81.00	\$55.00
500 g	115923	\$75.00	\$55.00
200 g	115922	\$59.00	\$55.00
100 g	111934	\$51.00	\$40.00
50 g	111935	\$46.50	\$40.00
20 g	111936	\$41.00	\$40.00
10 g	111937	\$41.00	\$40.00
5 g	111938	\$37.50	\$40.00
2 g	111939	\$37.50	\$40.00
1 g	111940	\$37.50	\$40.00

Optional Certificate

Replacement Cases

Main Cases		
Class M1		
Nominal Value	Part #	Price
20 kg	156290	\$560.00
10 kg	156289	\$560.00
5 kg	Consult	Consult
2 kg	190266	\$38.50
1 kg	190262	\$38.50
500 g	189711	\$38.50
200 g	196466	\$37.50
100 g	189566	\$42.00
50 g	189487	\$42.00
20 g	189477	\$42.00
10 g	189351	\$42.00
5 g	189240	\$42.00
2 g	189236	\$42.00
1 g	188285	\$42.00
500 mg	50038	\$5.00
200 mg	50038	\$5.00
100 mg	50038	\$5.00
50 mg	50038	\$5.00
20 mg	50038	\$5.00
10 mg	50038	\$5.00
5 mg	50038	\$5.00
2 mg	50038	\$5.00
1 mg	50038	\$5.00

Replacement Cases

Main Cases		
Class M2		
Nominal Value	Part #	Price
5 kg	Consult	Consult
2 kg	190266	\$38.50
1 kg	190262	\$38.50
500 g	189711	\$38.50
200 g	196466	\$37.50
100 g	189566	\$42.00
50 g	189487	\$42.00
20 g	189477	\$42.00
10 g	189351	\$42.00
5 g	189240	\$42.00
2 g	189236	\$42.00
1 g	188285	\$42.00



Accessories

Description	Part #	Price
Statement of Accuracy	36092	\$47.50
Weight glove, white cotton	11714	\$6.75
Premium tweezer	152414	\$43.00

MASS REFERENCE STANDARDS / METRIC SETS

RANGE: 500 mg – 50 g

Class E1 Polished Finish

Statement of Accuracy not available.

Set Range	Part #	Price
500 mg - 1 mg	30850	\$2,170.00
500 mg - 100 mg	30854	\$1,100.00

Certificate

Accredited
Included
Included

Class E2 Polished Finish

Statement of Accuracy not available.

Set Range	Part #	Price
500 mg - 1 mg	30851	\$1,480.00
500 mg - 100 mg	30855	\$940.00
50 g - 1 mg	96477	\$2,210.00
50 g - 1g	96478	\$1,210.00

Certificate

Accredited
Included
Included
Included
Included

Class F1 Polished Finish

Set Range	Part #	Price
500 mg - 1 mg	30852	\$615.00
500 mg - 100 mg	30856	\$450.00
50 g - 1 mg	96479	\$1,200.00
50 g - 1g	96480	\$730.00

Optional Certificate

Accredited	Non-accredited
\$470.00	\$375.00
\$155.00	\$125.00
\$790.00	\$630.00
\$310.00	\$250.00

Class F2 Polished Finish

Set Range	Part #	Price
500 mg - 1 mg	30853	\$610.00
500 mg - 100 mg	30857	\$345.00
50 g - 1 mg	96481	\$980.00
50 g - 1g	96482	\$715.00

Optional Certificate

Accredited	Non-accredited
\$470.00	\$375.00
\$155.00	\$125.00
\$790.00	\$630.00
\$310.00	\$250.00

Class M1 Satin Finish

Set Range	Part #	Price
500 mg - 1 mg	161537	\$450.00

Optional Certificate

Accredited
\$280.00

Weight Set Contents

500 mg - 1 mg	500 mg - 100 mg	50 g - 1 mg	50 g - 1g
30850 Class E1	30854 Class E1	–	–
30851 Class E2	30855 Class E2	96477 Class E2	96478 Class E2
30852 Class F1	30856 Class F1	96479 Class F1	96480 Class F1
30853 Class F2	30857 Class F2	96481 Class F2	96482 Class F2
161537 Class M1	–	–	–
–	–	(1) 50 g	(1) 50 g
–	–	(2) 20 g	(2) 20 g
–	–	(1) 10 g	(1) 10 g
–	–	(1) 5 g	(1) 5 g
–	–	(2) 2 g	(2) 2 g
–	–	(1) 1 g	(1) 1 g
(1) 500 mg	(1) 500 mg	(1) 500 mg	
(2) 200 mg	(2) 200 mg	(2) 200 mg	
(1) 100 mg	(1) 100 mg	(1) 100 mg	
(1) 50 mg		(1) 50 mg	
(2) 20 mg		(2) 20 mg	
(1) 10 mg		(1) 10 mg	
(1) 5 mg		(1) 5 mg	
(2) 2 mg		(2) 2 mg	
(1) 1 mg		(1) 1 mg	
12 pcs. 1.11g set wt.	4 pcs. 1g set wt.	20 pcs. 111.11g set wt.	8 pcs. 108g set wt.



Set Includes Lifting Device, Glove and Case

Replacement Cases

Main Cases		
Class E1		
Set Range	Part #	Price
500 mg - 1 mg	34699	\$125.00
500 mg - 100 mg	34699	\$125.00

Main Case		
Class E2		
Set Range	Part #	Price
500 mg - 1 mg	34699	\$125.00
500 mg - 100 mg	34699	\$125.00
50 g - 1 mg	34697	\$225.00
50 g - 1g	34697	\$225.00

Main Cases		
Class F1		
Set Range	Part #	Price
500 mg - 1 mg	34699	\$125.00
500 mg - 100 mg	34699	\$125.00
50 g - 1 mg	34697	\$225.00
50 g - 1g	34697	\$225.00

Main Cases		
Class F2		
Set Range	Part #	Price
500 mg - 1 mg	34699	\$125.00
500 mg - 100 mg	34699	\$125.00
50 g - 1 mg	34697	\$225.00
50 g - 1g	34697	\$225.00

Accessories

Description	Part #	Price
Statement of Accuracy	36092	\$47.50
Weight glove, white cotton	11714	\$6.75
Tweezer	11711	\$5.00
Premium tweezer	152414	\$43.00
Serial number	25836	\$17.00
Leaf weight cover	11755	\$43.00
Weight forceps, plastic	50035	\$43.00
Tong assembly, Class 0	50000	\$74.00
Lifter (Class 0 and OIML 2 kg and 5 kg)	50037	\$54.00

ASTM
PRECISION

OIML
PRECISION

BALANCE
CALIBRATION

STAINLESS
FIELD WEIGHTS

CAST IRON
FIELD WEIGHTS

ASTM
SPECIALTY

ACCESSORIES

MASS REFERENCE STANDARDS / METRIC SETS

RANGE: 100 g

Class E1 Polished Finish
*Statement of Accuracy not available.***Certificate**

Set Range	Part #	Price	Accredited
100 g - 1 mg	30838	\$5,325.00	Included
100 g - 100 mg	30842	\$4,175.00	Included
100 g - 1 g	30846	\$3,450.00	Included

Class E2 Polished Finish
*Statement of Accuracy not available.***Certificate**

Set Range	Part #	Price	Accredited
100 g - 1 mg	30839	\$2,440.00	Included
100 g - 100 mg	30843	\$1,750.00	Included
100 g - 1 g	30847	\$1,300.00	Included

Class F1 Polished Finish**Optional Certificate**

Set Range	Part #	Price	Accredited	Non-accredited
100 g - 1 mg	30840	\$1,270.00	\$830.00	\$590.00
100 g - 100 mg	30844	\$1,070.00	\$510.00	\$405.00
100 g - 1 g	30848	\$835.00	\$355.00	\$280.00

Class F2 Polished Finish**Optional Certificate**

Set Range	Part #	Price	Accredited	Non-accredited
100 g - 1 mg	30841	\$1,000.00	\$830.00	\$590.00
100 g - 100 mg	30845	\$985.00	\$510.00	\$405.00
100 g - 1 g	30849	\$800.00	\$355.00	\$280.00

Class M1 Satin Finish**Optional Certificate**

Set Range	Part #	Price	Accredited
100 g - 1 mg	119561	\$950.00	\$505.00
100 g - 1 g	119560	\$660.00	\$215.00

Replacement Cases

Main Cases		
Class E1		
Set Range	Part #	Price
100 g - 1 mg	34697	\$225.00
100 g - 100 mg	34697	\$225.00
100 g - 1 g	34697	\$225.00

Main Case		
Class E2		
Set Range	Part #	Price
100 g - 1 mg	34697	\$225.00
100 g - 100 mg	34697	\$225.00

Main Case		
Class E2		
Set Range	Part #	Price
100 g - 1 g	34697	\$225.00

Main Cases		
Class F1		
Set Range	Part #	Price
100 g - 1 mg	34697	\$225.00
100 g - 100 mg	34697	\$225.00
100 g - 1 g	34697	\$225.00

Main Cases		
Class F2		
Set Range	Part #	Price
100 g - 1 mg	34697	\$225.00
100 g - 100 mg	34697	\$225.00
100 g - 1 g	34697	\$225.00

Main Cases		
Class M1		
Set Range	Part #	Price
100 g - 1 mg	34697	\$225.00
100 g - 1 g	34697	\$225.00

RANGE: 100 g

Weight Set Contents

100 g - 1 mg	100 g - 100 mg	100 g - 1 g
30838 Class E1	30842 Class E1	30846 Class E1
30839 Class E2	30843 Class E2	30847 Class E2
30840 Class F1	30844 Class F1	30848 Class F1
30841 Class F2	30845 Class F2	30849 Class F2
119561 Class M1	–	119560 Class M1
(1) 100 g	(1) 100 g	(1) 100 g
(1) 50 g	(1) 50 g	(1) 50 g
(2) 20 g	(2) 20 g	(2) 20 g
(1) 10 g	(1) 10 g	(1) 10 g
(1) 5 g	(1) 5 g	(1) 5 g
(2) 2 g	(2) 2 g	(2) 2 g
(1) 1 g	(1) 1 g	(1) 1 g
(1) 500 mg	(1) 500 mg	
(2) 200 mg	(2) 200 mg	
(1) 100 mg	(1) 100 mg	
(1) 50 mg		
(2) 20 mg		
(1) 10 mg		
(1) 5 mg		
(2) 2 mg		
(1) 1 mg		
21 pcs. 211.11g set wt.	13 pcs. 211g set wt.	9 pcs. 210g set wt.



Accessories

Description	Part #	Price
Statement of Accuracy	36092	\$47.50
Weight glove, white cotton	11714	\$6.75
Tweezer	11711	\$5.00
Premium tweezer	152414	\$43.00
Serial number	25836	\$17.00
Leaf weight cover	11755	\$43.00
Weight forceps, plastic	50035	\$43.00

PN 30838 Set Includes Lifting Device, Glove and Case (100 g to 1 mg)

ASTM
PRECISION

OIML
PRECISION

BALANCE
CALIBRATION

STAINLESS
FIELD WEIGHTS

CAST IRON
FIELD WEIGHTS

ASTM
SPECIALTY

ACCESSORIES

MASS REFERENCE STANDARDS / METRIC SETS

RANGE: 200 g

ASTM
PRECISION

OIML
PRECISION

BALANCE
CALIBRATION

STAINLESS
FIELD WEIGHTS

CAST IRON
FIELD WEIGHTS

ASTM
SPECIALTY

ACCESSORIES

Class E1 Polished Finish
Statement of Accuracy not available.

Certificate

Set Range	Part #	Price	Accredited
(2) 200 g - 1mg	40546	\$5,700.00	Included
200 g - 100 mg	40547	\$4,850.00	Included
200 g - 1g	40548	\$4,150.00	Included
200 g - 100 g	40549	\$2,450.00	Included

Class E2 Polished Finish
Statement of Accuracy not available.

Certificate

Set Range	Part #	Price	Accredited
200 g - 1mg	40550	\$2,775.00	Included
(2) 200 g - 1mg	96468	\$3,100.00	Included
200 g - 100 mg	40551	\$2,180.00	Included
200 g - 1g	40552	\$1,720.00	Included
(2) 200 g - 1g	96469	\$2,070.00	Included
(2) 200 g - 100 g	40553	\$1,380.00	Included

Class F1 Polished Finish

Optional Certificate

Set Range	Part #	Price	Accredited	Non-accredited
200 g - 1mg	40554	\$1,790.00	\$930.00	\$660.00
(2) 200 g - 1mg	96470	\$1,830.00	\$1,020.00	\$675.00
200 g - 100 mg	40555	\$1,370.00	\$610.00	\$450.00
(2) 200 g - 1g	96471	\$1,230.00	\$450.00	\$325.00
200 g - 1g	40556	\$1,140.00	\$540.00	\$370.00
(2) 200 g - 100 g	40557	\$780.00	\$300.00	\$155.00

Class F2 Polished Finish

Optional Certificate

Set Range	Part #	Price	Accredited	Non-accredited
200 g - 1mg	40558	\$1,760.00	\$930.00	\$660.00
(2) 200 g - 1mg	96472	\$1,790.00	\$1,020.00	\$675.00
200 g - 100 mg	40559	\$1,230.00	\$610.00	\$450.00
(2) 200 g - 1g	96473	\$1,170.00	\$450.00	\$325.00
200 g - 1g	40560	\$1,120.00	\$540.00	\$370.00
(2) 200 g - 100 g	40561	\$775.00	\$300.00	\$155.00

Class M1 Satin Finish

Optional Certificate

Set Range	Part #	Price	Accredited	Non-accredited
200 g - 1mg	195668	Consult	Consult	Consult
200 g - 1g	195669	Consult	Consult	Consult

Replacement Cases

Main Cases		
Class E1		
Set Range	Part #	Price
(2) 200 g - 1mg	34645	\$330.00
200 g - 100 mg	34645	\$330.00
200 g - 1g	34645	\$330.00
200 g - 100 g	34645	\$330.00

Main Cases		
Class E2		
Set Range	Part #	Price
200 g - 1mg	34645	\$330.00
(2) 200 g - 1mg	34645	\$330.00
200 g - 100 mg	34645	\$330.00
200 g - 1g	34645	\$330.00
(2) 200 g - 1g	34645	\$330.00
(2) 200 g - 100 g	34645	\$330.00

Main Cases		
Class F1		
Set Range	Part #	Price
200 g - 1mg	34645	\$330.00
(2) 200 g - 1mg	34645	\$330.00
200 g - 100 mg	34645	\$330.00
(2) 200 g - 1g	34645	\$330.00
200 g - 1g	34645	\$330.00
(2) 200 g - 100 g	34645	\$330.00

RANGE: 200 g

Weight Set Contents

200 g - 1mg	(2) 200 g - 1mg	200 g - 100 mg	200 g - 1g	(2) 200 g - 1g	(2) 200 g - 100 g
40550 Class E1 40554 Class E2 40558 Class F1 195668 Class F2 -	40546 Class E1 96468 Class E2 96470 Class F1 96472 Class F2 -	40547 Class E1 40551 Class E2 40555 Class F1 40559 Class F2 -	40548 Class E1 40552 Class E2 40556 Class F1 40560 Class F2 195669 Class M1	- 96469 Class E2 96471 Class F1 96473 Class F2 -	40549 Class E1 40553 Class E2 40557 Class F1 40561 Class F2 -
(1) 200 g (1) 100 g (1) 50 g (2) 20 g (1) 10 g (1) 5 g (2) 2 g (1) 1 g (1) 500 mg (2) 200 mg (1) 100 mg (1) 50 mg (2) 20 mg (1) 10 mg (1) 5 mg (2) 2 mg (1) 1 mg	(2) 200 g (1) 100 g (1) 50 g (2) 20 g (1) 10 g (1) 5 g (2) 2 g (1) 1 g (1) 500 mg (2) 200 mg (1) 100 mg (1) 50 mg (2) 20 mg (1) 10 mg (1) 5 mg (2) 2 mg (1) 1 mg	(1) 200 g (1) 100 g (1) 50 g (2) 20 g (1) 10 g (1) 5 g (2) 2 g (1) 1 g (1) 500 mg (2) 200 mg (1) 100 mg	(1) 200 g (1) 100 g (1) 50 g (2) 20 g (1) 10 g (1) 5 g (2) 2 g (1) 1 g	(2) 200 g (1) 100 g (1) 50 g (2) 20 g (1) 10 g (1) 5 g (2) 2 g (1) 1 g	(2) 200 g (1) 100 g
22 pcs. 411.11g set wt.	23 pcs. 611.11g set wt.	14 pcs. 611g set wt.	10 pcs. 410g set wt.	11 pcs. 610g set wt.	3 pcs. 500g set wt.



Set Includes Lifting Device, Glove and Case

Main Cases		
Class F2		
Set Range	Part #	Price
200 g - 1mg	34645	\$330.00
(2) 200 g - 1mg	34645	\$330.00
200 g - 100 mg	34645	\$330.00
(2) 200 g - 1g	34645	\$330.00
200 g - 1g	34645	\$330.00
(2) 200 g - 100 g	34645	\$330.00

Main Cases		
Class M1		
Set Range	Part #	Price
200 g - 1mg	Consult	Consult
200 g - 1g	Consult	Consult

Inserts		
Class E1, E2, F1 and M1		
Set Range	Part #	Price
200 g - 1mg	30607	\$205.00
(2) 200 g - 1mg	84473	\$400.00
(2) 200 g - 1g	84472	\$400.00
(2) 200 g - 100 g	30608	\$395.00

Accessories

Description	Part #	Price
Statement of Accuracy	36092	\$47.50
Weight glove, white cotton	11714	\$6.75
Tweezer	11711	\$5.00
Premium tweezers	152414	\$43.00
Serial number	25836	\$17.00
Leaf weight cover	11755	\$43.00
Weight forceps, plastic	50035	\$43.00

ASTM
PRECISION

OIML
PRECISION

BALANCE
CALIBRATION

STAINLESS
FIELD WEIGHTS

CAST IRON
FIELD WEIGHTS

ASTM
SPECIALTY

ACCESSORIES

MASS REFERENCE STANDARDS / METRIC SETS

RANGE: 500 g

Class E1 Polished Finish

Statement of Accuracy not available.

Certificate

Set Range	Part #	Price	Accredited
500 g - 1mg	30822	\$6,850.00	Included
500 g - 100 mg	30826	\$6,050.00	Included
500 g - 1g	30830	\$5,475.00	Included
500 g - 100 g	30834	\$4,600.00	Included

Class E2 Polished Finish

Statement of Accuracy not available.

Certificate

Set Range	Part #	Price	Accredited
500 g - 1mg	30823	\$3,650.00	Included
500 g - 100 mg	30827	\$3,150.00	Included
500 g - 1g	30831	\$2,525.00	Included
500 g - 100 g	30835	\$1,840.00	Included

Class F1 Polished Finish**Optional Certificate**

Set Range	Part #	Price	Accredited	Non-accredited
500 g - 1mg	30824	\$2,170.00	\$1,120.00	\$715.00
500 g - 100 mg	30828	\$1,930.00	\$800.00	\$535.00
500 g - 1g	30832	\$1,610.00	\$640.00	\$410.00
500 g - 100 g	30836	\$1,410.00	\$325.00	\$165.00

Class F2 Polished Finish**Optional Certificate**

Set Range	Part #	Price	Accredited	Non-accredited
500 g - 1mg	30825	\$1,840.00	\$1,120.00	\$715.00
500 g - 100 mg	30829	\$1,710.00	\$800.00	\$535.00
500 g - 1g	30833	\$1,430.00	\$640.00	\$410.00
500 g - 100 g	30837	\$1,040.00	\$325.00	\$165.00

Class M1 Satin Finish**Optional Certificate**

Set Range	Part #	Price	Accredited	Non-accredited
500 g - 1mg	195670	Consult	Consult	Consult
500 g - 1g	195671	Consult	Consult	Consult

Replacement Cases

Main Cases		
Class E1		
Set Range	Part #	Price
500 g - 1mg	34645	\$330.00
500 g - 100 mg	34645	\$330.00
500 g - 1g	34645	\$330.00
500 g - 100 g	34645	\$330.00

Main Cases		
Class E2		
Set Range	Part #	Price
500 g - 1mg	34645	\$330.00
500 g - 100 mg	34645	\$330.00
500 g - 1g	34645	\$330.00
500 g - 100 g	34645	\$330.00

Main Cases		
Class F1		
Set Range	Part #	Price
500 g - 1mg	34645	\$330.00
500 g - 100 mg	34645	\$330.00
500 g - 1g	34645	\$330.00
500 g - 100 g	34645	\$330.00

RANGE: 500 g

Weight Set Contents

500 g to 1 mg	500 g to 100 mg	500 g - 1 g	500 g - 100 g
30822 Class E1	30826 Class E1	30830 Class E1	30834 Class E1
30823 Class E2	30827 Class E2	30831 Class E2	30835 Class E2
30824 Class F1	30828 Class F1	30832 Class F1	30836 Class F1
30825 Class F2	30829 Class F2	30833 Class F2	30837 Class F2
195670 Class M1	–	195671 Class M1	–
(1) 500 g (2) 200 g (1) 100 g (1) 50 g (2) 20 g (1) 10 g (1) 5 g (2) 2 g (1) 1 g (1) 500 mg (2) 200 mg (1) 100 mg (1) 50 mg (2) 20 mg (1) 10 mg (1) 5 mg (2) 2 mg (1) 1 mg	(1) 500 g (2) 200 g (1) 100 g (1) 50 g (2) 20 g (1) 10 g (1) 5 g (2) 2 g (1) 1 g (1) 500 mg (2) 200 mg (1) 100 mg	(1) 500 g (2) 200 g (1) 100 g (1) 50 g (2) 20 g (1) 10 g (1) 5 g (2) 2 g (1) 1 g	(1) 500 g (2) 200 g (1) 100 g
24 pcs. 1.11111 kg set wt.	16 pcs. 1.111 kg set wt.	12 pcs. 1.11 kg set wt.	4 pcs. 1 kg set wt.



Set Includes Lifting Device, Glove and Case

Main Cases		
Class F2		
Set Range	Part #	Price
500 g - 1 mg	34645	\$330.00
500 g - 100 mg	34645	\$330.00
500 g - 1 g	34645	\$330.00
500 g - 100 g	34645	\$330.00

Main Cases		
Class M1		
Set Range	Part #	Price
500 g - 1 mg	Consult	Consult
500 g - 1 g	Consult	Consult

Inserts		
Class E1, E2, F1, F2 and M1		
Set Range	Part #	Price
500 g - 1 mg	30607	\$205.00
500 g - 100 g	30608	\$395.00

Accessories

Description	Part #	Price
Statement of Accuracy	36092	\$47.50
Weight glove, white cotton	11714	\$6.75
Tweezer	11711	\$5.00
Premium tweezer	152414	\$43.00
Serial number	25836	\$17.00
Leaf weight cover	11755	\$43.00
Weight forceps, plastic	50035	\$43.00
Tong assembly 1 kg - 200 g	50000	\$74.00

ASTM
PRECISION

OIML
PRECISION

BALANCE
CALIBRATION

STAINLESS
FIELD WEIGHTS

CAST IRON
FIELD WEIGHTS

ASTM
SPECIALTY

ACCESSORIES

MASS REFERENCE STANDARDS / METRIC SETS

RANGE: 1kg

Class E1 Polished Finish

Statement of Accuracy not available.

Certificate

Set Range	Part #	Price	Accredited
1kg - 1mg	30806	\$7,825.00	Included
1kg - 100 mg	30810	\$6,625.00	Included
1kg - 1g	30814	\$5,975.00	Included
1kg - 100 g	30818	\$4,050.00	Included

Class E2 Polished Finish

Statement of Accuracy not available.

Certificate

Set Range	Part #	Price	Accredited
1kg - 1mg	30807	\$4,275.00	Included
1kg - 100 mg	30811	\$4,275.00	Included
1kg - 1g	30815	\$3,700.00	Included
1kg - 100 g	30819	\$2,950.00	Included

Class F1 Polished Finish**Optional Certificate**

Set Range	Part #	Price	Accredited	Non-accredited
1kg - 1mg	30808	\$3,075.00	\$1,120.00	\$765.00
1kg - 100 mg	30812	\$2,950.00	\$900.00	\$525.00
1kg - 1g	30816	\$2,850.00	\$730.00	\$455.00
1kg - 100 g	30820	\$2,490.00	\$415.00	\$205.00

Class F2 Polished Finish**Optional Certificate**

Set Range	Part #	Price	Accredited	Non-accredited
1kg - 1mg	30809	\$2,975.00	\$1,120.00	\$765.00
1kg - 100 mg	30813	\$2,900.00	\$900.00	\$525.00
1kg - 1g	30817	\$2,825.00	\$730.00	\$455.00
1kg - 100 g	30821	\$2,180.00	\$415.00	\$205.00

Class M1 Satin Finish**Optional Certificate**

Set Range	Part #	Price	Accredited	Non-accredited
1kg - 1mg	159154	\$2,170.00	Consult	Consult
1kg - 1g	159155	\$1,770.00	Consult	Consult

Replacement Cases

Main Cases		
Class E1		
Set Range	Part #	Price
1kg - 1mg	30605	\$1,960.00
1kg - 100 mg	30605	\$1,960.00
1kg - 1g	30605	\$1,960.00
1kg - 100 g	30606	\$1,770.00

Main Cases		
Class E2		
Set Range	Part #	Price
1kg - 1mg	30605	\$1,960.00
1kg - 100 mg	30605	\$1,960.00
1kg - 1g	30605	\$1,960.00
1kg - 100 g	30606	\$1,770.00

Main Cases		
Class F1		
Set Range	Part #	Price
1kg - 1mg	30605	\$1,960.00
1kg - 100 mg	30605	\$1,960.00
1kg - 1g	30605	\$1,960.00
1kg - 100 g	30606	\$1,770.00

RANGE: 1kg

Weight Set Contents

1kg - 1mg		1kg - 100 mg		1kg - 1g		1kg - 100 g	
30806	Class E1	30810	Class E1	30814	Class E1	30818	Class E1
30807	Class E2	30811	Class E2	30815	Class E2	30819	Class E2
30808	Class F1	30812	Class F1	30816	Class F1	30820	Class F1
30809	Class F2	30813	Class F2	30817	Class F2	30821	Class F2
159154	Class M1	–		159155	Class M1	–	
(1) 1kg		(1) 1kg		(1) 1kg		(1) 1kg	
(1) 500 g		(1) 500 g		(1) 500 g		(1) 500 g	
(2) 200 g		(2) 200 g		(2) 200 g		(2) 200 g	
(1) 100 g		(1) 100 g		(1) 100 g		(1) 100 g	
(1) 50 g		(1) 50 g		(1) 50 g			
(2) 20 g		(2) 20 g		(2) 20 g			
(1) 10 g		(1) 10 g		(1) 10 g			
(1) 5 g		(1) 5 g		(1) 5 g			
(2) 2 g		(2) 2 g		(2) 2 g			
(1) 1 g		(1) 1 g		(1) 1 g			
(1) 500 mg		(1) 500 mg					
(2) 200 mg		(2) 200 mg					
(1) 100 mg		(1) 100 mg					
(1) 50 mg							
(2) 20 mg							
(1) 10 mg							
(1) 5 mg							
(2) 2 mg							
(1) 1 mg							
25 pcs.		17 pcs.		13 pcs.		5 pcs.	
2.11111kg set wt.		2.111kg set wt.		2.11kg set wt.		2kg set wt.	



PN 30806 Set Includes Lifting Device, Glove and Case (1 kg to 1 mg)

Main Cases		
Class F2		
Set Range	Part #	Price
1kg - 1mg	30605	\$1,960.00
1kg - 100 mg	30605	\$1,960.00
1kg - 1g	30605	\$1,960.00
1kg - 100 g	30606	\$1,770.00

Main Cases		
Class M1		
Set Range	Part #	Price
1kg - 1mg	Consult	Consult
1kg - 1g	Consult	Consult
Secondary Case		
Set Range	Part #	Price
100 g - 1mg	34697	\$225.00

Accessories

Description	Part #	Price
Statement of Accuracy	36092	\$47.50
Weight glove, white cotton	11714	\$6.75
Tweezer	11711	\$5.00
Premium tweezer	152414	\$43.00
Serial number	25836	\$17.00
Leaf weight cover	11755	\$43.00
Weight forceps, plastic	50035	\$43.00
Tong assembly 1kg - 200 g	50000	\$74.00

ASTM
PRECISION

OIML
PRECISION

BALANCE
CALIBRATION

STAINLESS
FIELD WEIGHTS

CAST IRON
FIELD WEIGHTS

ASTM
SPECIALTY

ACCESSORIES

MASS REFERENCE STANDARDS / METRIC SETS

RANGE: 2 kg

Class E1 Polished Finish

Statement of Accuracy not available.

Certificate

Set Range	Part #	Price	Accredited
2 kg - 1 mg	40518	\$10,300.00	Included
2 kg - 100 mg	40519	\$8,975.00	Included
2 kg - 1 g	40520	\$7,525.00	Included
2 kg - 100 g	40521	\$5,500.00	Included

Class E2 Polished Finish

Statement of Accuracy not available.

Certificate

Set Range	Part #	Price	Accredited
2 kg - 1 mg	40523	\$5,325.00	Included
(2) 2 kg - 1 mg	96455	\$5,875.00	Included
2 kg - 1 g	40525	\$4,200.00	Included
(2) 2 kg - 1 g	96457	\$5,300.00	Included

Class F1 Polished Finish**Optional Certificate**

Set Range	Part #	Price	Accredited	Non-accredited
2 kg - 1 mg	40528	\$4,200.00	\$1,310.00	\$900.00
(2) 2 kg - 1 mg	96459	\$4,375.00	\$1,430.00	\$960.00
2 kg - 1 g	40530	\$3,250.00	\$840.00	\$510.00
(2) 2 kg - 1 g	96461	\$3,825.00	\$960.00	\$570.00

Class F2 Polished Finish**Optional Certificate**

Set Range	Part #	Price	Accredited	Non-accredited
2 kg - 1 mg	40533	\$3,625.00	\$1,310.00	\$900.00
(2) 2 kg - 1 mg	96463	\$3,625.00	\$1,430.00	\$960.00
2 kg - 1 g	40535	\$3,200.00	\$840.00	\$510.00
(2) 2 kg - 1 g	96465	\$3,700.00	\$960.00	\$570.00

Class M1 Satin Finish**Optional Certificate**

Set Range	Part #	Price	Accredited	Non-accredited
2 kg - 1 mg	195672	\$2,775.00	Consult	Consult
2 kg - 1 g	195673	\$2,000.00	Consult	Consult



Set Includes Lifting Device, Glove and Case (1 kg to 1 mg)

Replacement Cases

Main Cases		
Class E1		
Set Range	Part #	Price
2 kg - 1 mg	84474	\$1,970.00
2 kg - 100 mg	96308	\$1,970.00
2 kg - 1 g	84474	\$1,970.00
2 kg - 100 g	96308	\$1,970.00

Main Cases		
Class E2		
Set Range	Part #	Price
2 kg - 1 mg	84474	\$1,970.00
2 kg - 100 mg	96308	\$1,970.00
2 kg - 1 g	84474	\$1,970.00
2 kg - 100 g	96308	\$1,970.00

Main Cases		
Class F1		
Set Range	Part #	Price
2 kg - 1 mg	96308	\$1,970.00
(2) 2 kg - 1 mg	84474	\$1,970.00
2 kg - 1 g	96308	\$1,970.00
(2) 2 kg - 1 g	84474	\$1,970.00

RANGE: 2 kg

Weight Set Contents

2 kg - 1 mg	2 kg - 100 mg	(2) 2 kg - 1 mg	2 kg - 1 g	(2) 2 kg - 1 g	2 kg - 100 g
40518 Class E1 40523 Class E2 40528 Class F1 40533 Class F2 195672 Class M1	40519 Class E1 - - - -	- 96455 Class E2 96459 Class F1 96463 Class F2 -	40520 Class E1 40525 Class E2 40530 Class F1 40535 Class F2 195673 Class M1	- 96457 Class E2 96461 Class F1 96465 Class F2 -	40521 Class E1 - - - -
(1) 2 kg (1) 1 kg (1) 500 g (2) 200 g (1) 100 g (1) 50 g (2) 20 g (1) 10 g (1) 5 g (2) 2 g (1) 1 g (1) 500 mg (2) 200 mg (1) 100 mg (1) 50 mg (2) 20 mg (1) 10 mg (1) 5 mg (2) 2 mg (1) 1 mg	(1) 2 kg (1) 1 kg (1) 500 g (2) 200 g (1) 100 g (1) 50 g (2) 20 g (1) 10 g (1) 5 g (2) 2 g (1) 1 g (1) 500 mg (2) 200 mg (1) 100 mg (1) 50 mg (2) 20 mg (1) 10 mg (1) 5 mg (2) 2 mg (1) 1 mg	(2) 2 kg (1) 1 kg (1) 500 g (2) 200 g (1) 100 g (1) 50 g (2) 20 g (1) 10 g (1) 5 g (2) 2 g (1) 1 g (1) 500 mg (2) 200 mg (1) 100 mg (1) 50 mg (2) 20 mg (1) 10 mg (1) 5 mg (2) 2 mg (1) 1 mg	(1) 2 kg (1) 1 kg (1) 500 g (2) 200 g (1) 100 g (1) 50 g (2) 20 g (1) 10 g (1) 5 g (2) 2 g (1) 1 g	(2) 2 kg (1) 1 kg (1) 500 g (2) 200 g (1) 100 g (1) 50 g (2) 20 g (1) 10 g (1) 5 g (2) 2 g (1) 1 g	(1) 2 kg (1) 1 kg (1) 500 g (2) 200 g (1) 100 g
26 pcs. 4.11111 kg set wt.	18 pcs. 4.111 kg set wt.	27 pcs. 6.11111 kg set wt.	14 pcs. 4.11 kg set wt.	15 pcs. 4.11 kg set wt.	6 pcs. 4.0 kg set wt.

ASTM
PRECISION

OIML
PRECISION

BALANCE
CALIBRATION

STAINLESS
FIELD WEIGHTS

CAST IRON
FIELD WEIGHTS

ASTM
SPECIALTY

ACCESSORIES

Main Cases		
Class F2		
Set Range	Part #	Price
2 kg - 1 mg	96308	\$1,970.00
(2) 2 kg - 1 mg	84474	\$1,970.00
2 kg - 1 g	96308	\$1,970.00
(2) 2 kg - 1 g	84474	\$1,970.00

Main Cases		
Class M1		
Set Range	Part #	Price
2 kg - 1 mg	Consult	Consult
2 kg - 1 g	Consult	Consult

Secondary Case		
Set Range	Part #	Price
100 g - 1 mg	34697	\$225.00

Accessories

Description	Part #	Price
Statement of Accuracy	36092	\$47.50
Weight glove, white cotton	11714	\$6.75
Tweezer	11711	\$5.00
Premium tweezer	152414	\$43.00
Serial number	25836	\$17.00
Leaf weight cover	11755	\$43.00
Weight forceps, plastic	50035	\$43.00
Tong assembly 1 kg - 200 g	50000	\$74.00
Lifter, 5 kg and 2 kg	50037	\$54.00

MASS REFERENCE STANDARDS / METRIC SETS

RANGE: 5 kg

ASTM
PRECISION

OIML
PRECISION

BALANCE
CALIBRATION

STAINLESS
FIELD WEIGHTS

CAST IRON
FIELD WEIGHTS

ASTM
SPECIALTY

ACCESSORIES

Class E1 Polished Finish
Statement of Accuracy not available.

Certificate

Set Range	Part #	Price	Accredited
5 kg - 1 mg	30785	\$12,150.00	Included
5 kg - 100 mg	30789	\$11,700.00	Included
5 kg - 1 g	30793	\$11,225.00	Included
5 kg - 100 g	30797	\$7,925.00	Included
5 kg - 1 kg	30802	\$6,700.00	Included

Class E2 Polished Finish
Statement of Accuracy not available.

Certificate

Set Range	Part #	Price	Accredited
5 kg - 1 mg	30786	\$6,925.00	Included
5 kg - 100 mg	30790	\$6,650.00	Included
5 kg - 1 g	30794	\$6,000.00	Included
5 kg - 100 g	30798	\$5,275.00	Included
5 kg - 1 kg	30803	\$4,475.00	Included

Class F1 Polished Finish

Optional Certificate

Set Range	Part #	Price	Accredited	Non-accredited
5 kg - 1 mg	30787	\$5,175.00	\$1,400.00	\$840.00
5 kg - 100 mg	30791	\$5,275.00	\$1,225.00	\$765.00
5 kg - 1 g	30795	\$4,875.00	\$1,075.00	\$635.00
5 kg - 100 g	30800	\$4,475.00	\$755.00	\$380.00
5 kg - 1 kg	30804	\$4,225.00	\$385.00	\$220.00

Class F2 Polished Finish

Optional Certificate

Set Range	Part #	Price	Accredited	Non-accredited
5 kg - 1 mg	30788	\$4,750.00	\$1,400.00	\$840.00
5 kg - 100 mg	30792	\$4,600.00	\$1,225.00	\$765.00
5 kg - 1 g	30796	\$4,200.00	\$1,075.00	\$635.00
5 kg - 100 g	30801	\$3,850.00	\$755.00	\$380.00
5 kg - 1 kg	30805	\$3,550.00	\$385.00	\$220.00

Class M1 Satin Finish

Optional Certificate

Set Range	Part #	Price	Accredited
5 kg - 1 mg	126169	\$2,750.00	\$780.00
5 kg - 1 g	126168	\$2,370.00	\$490.00

Replacement Cases

Main Cases		
Class E1		
Set Range	Part #	Price
5 kg - 1 mg	30602	\$1,920.00
5 kg - 100 mg	30602	\$1,920.00
5 kg - 1 g	30602	\$1,920.00
5 kg - 100 g	30603	\$1,920.00
5 kg - 1 kg	30604	\$1,770.00

Main Cases		
Class E2		
Set Range	Part #	Price
5 kg - 1 mg	30602	\$1,920.00
5 kg - 100 mg	30602	\$1,920.00
5 kg - 1 g	30602	\$1,920.00
5 kg - 100 g	30603	\$1,920.00
5 kg - 1 kg	30604	\$1,770.00

Main Cases		
Class F1		
Set Range	Part #	Price
5 kg - 1 mg	30602	\$1,920.00
5 kg - 100 mg	30602	\$1,920.00
5 kg - 1 g	30602	\$1,920.00
5 kg - 100 g	30603	\$1,920.00
5 kg - 1 kg	30604	\$1,770.00

RANGE: 5 kg

ASTM
PRECISION

OIML
PRECISION

BALANCE
CALIBRATION

STAINLESS
FIELD WEIGHTS

CAST IRON
FIELD WEIGHTS

ASTM
SPECIALTY

ACCESSORIES

Weight Set Contents

5 kg - 1 mg	5 kg - 100 mg	5 kg - 1 g	5 kg - 100 g	5 kg - 1 kg
30785 Class E1	30789 Class E1	30793 Class E1	30797 Class E1	30802 Class E1
30786 Class E2	30790 Class E2	30794 Class E2	30798 Class E2	30803 Class E2
30787 Class F1	30791 Class F1	30795 Class F1	30800 Class F1	30804 Class F1
30788 Class F2	30792 Class F2	30796 Class F2	30801 Class F2	30805 Class F2
126169 Class M1	-	126168 Class M1	-	-
(1) 5 kg (2) 2 kg (1) 1 kg (1) 500 g (2) 200 g (1) 100 g (1) 50 g (2) 20 g (1) 10 g (1) 5 g (2) 2 g (1) 1 g (1) 500 mg (2) 200 mg (1) 100 mg (1) 50 mg (2) 20 mg (1) 10 mg (1) 5 mg (2) 2 mg (1) 1 mg	(1) 5 kg (2) 2 kg (1) 1 kg (1) 500 g (2) 200 g (1) 100 g (1) 50 g (2) 20 g (1) 10 g (1) 5 g (2) 2 g (1) 1 g (1) 500 mg (2) 200 mg (1) 100 mg (1) 50 mg (2) 20 mg (1) 10 mg (1) 5 mg (2) 2 mg (1) 1 mg	(1) 5 kg (2) 2 kg (1) 1 kg (1) 500 g (2) 200 g (1) 100 g (1) 50 g (2) 20 g (1) 10 g (1) 5 g (2) 2 g (1) 1 g	(1) 5 kg (2) 2 kg (1) 1 kg (1) 500 g (2) 200 g (1) 100 g	(1) 5 kg (2) 2 kg (1) 1 kg
28 pcs. 11.11111 kg set wt.	20 pcs. 11.111 kg set wt.	16 pcs. 11.11 kg set wt.	8 pcs. 11 kg set wt.	4 pcs. 10 kg set wt.



Set Includes Lifting Device, Glove and Case (1 kg to 1 mg)

Main Cases		
Class F2		
Set Range	Part #	Price
5 kg - 1 mg	30602	\$1,920.00
5 kg - 100 mg	30602	\$1,920.00
5 kg - 1 g	30602	\$1,920.00
5 kg - 100 g	30603	\$1,920.00
5 kg - 1 kg	30604	\$1,770.00

Main Cases		
Class M1		
Set Range	Part #	Price
5 kg - 1 mg	126164	\$250.00
5 kg - 1 g	126164	\$250.00

Secondary Case		
Set Range	Part #	Price
100 g - 1 mg	34697	\$225.00

Accessories

Description	Part #	Price
Statement of Accuracy	36092	\$47.50
Weight glove, white cotton	11714	\$6.75
Tweezer	11711	\$5.00
Premium tweezer	152414	\$43.00
Serial number	25836	\$17.00
Leaf weight cover	11755	\$43.00
Weight forceps, plastic	50035	\$43.00
Tong assembly 1 kg - 200 g	50000	\$74.00
Lifter, 5 kg and 2 kg	50037	\$54.00

MASS REFERENCE STANDARDS / METRIC SETS

RANGE: 10 kg

Class E2 Polished Finish

Statement of Accuracy not available.

Certificate

Set Range	Part #	Price	Accredited
10 kg - 1mg	65213	\$9,850.00	Included
10 kg - 100mg	96419	\$9,525.00	Included
10 kg - 1g	96415	\$9,250.00	Included
10 kg - 100g	96420	\$8,100.00	Included
10 kg - 1kg	96421	\$7,225.00	Included

Class F1 Polished Finish**Optional Certificate**

Set Range	Part #	Price	Accredited	Non-accredited
10 kg - 1mg	65214	\$8,150.00	\$1,500.00	\$900.00
10 kg - 100mg	96429	\$8,025.00	\$1,325.00	\$820.00
10 kg - 1g	96430	\$7,875.00	\$1,180.00	\$690.00
10 kg - 100g	96467	\$7,400.00	\$870.00	\$440.00
10 kg - 1kg	96432	\$6,625.00	\$530.00	\$280.00

Class F2 Polished Finish**Optional Certificate**

Set Range	Part #	Price	Accredited	Non-accredited
10 kg - 1mg	65215	\$7,250.00	\$1,500.00	\$900.00
10 kg - 100mg	96445	\$7,125.00	\$1,325.00	\$820.00
10 kg - 1g	96446	\$7,025.00	\$1,180.00	\$690.00
10 kg - 100g	96444	\$6,450.00	\$870.00	\$440.00
10 kg - 1kg	96448	\$5,900.00	\$530.00	\$280.00

Class M1 Satin Finish**Optional Certificate**

Set Range	Part #	Price	Accredited	Non-accredited
10 kg - 1mg	195676	\$3,250.00	Consult	Consult
10 kg - 1g	195677	\$2,925.00	Consult	Consult

Replacement Cases

Main Cases		
Class E2		
Set Range	Part #	Price
10 kg - 1mg	65218	\$2,450.00
10 kg - 100mg	65218	\$2,450.00
10 kg - 1g	65218	\$2,450.00
10 kg - 100g	65218	\$2,450.00
10 kg - 1kg	65218	\$2,450.00

Main Cases		
Class F1		
Set Range	Part #	Price
10 kg - 1mg	65218	\$2,450.00
10 kg - 100mg	65218	\$2,450.00
10 kg - 1g	65218	\$2,450.00
10 kg - 100g	65218	\$2,450.00
10 kg - 1kg	65218	\$2,450.00

Main Cases		
Class F2		
Set Range	Part #	Price
10 kg - 1mg	65218	\$2,450.00
10 kg - 100mg	65218	\$2,450.00
10 kg - 1g	65218	\$2,450.00
10 kg - 100g	65218	\$2,450.00
10 kg - 1kg	65218	\$2,450.00

RANGE: 10 kg

Weight Set Contents

10 kg - 1 mg	10 kg - 100 mg	10 kg - 1 g	10 kg - 100 g	10 kg - 1 kg
65213 Class E2 65214 Class F1 65215 Class F2 195676 Class M1	96419 Class E2 96429 Class F1 96445 Class F2 -	96415 Class E2 96430 Class F1 96446 Class F2 195677 Class M1	96420 Class E2 96467 Class F1 96444 Class F2 -	96421 Class E2 96432 Class F1 96448 Class F2 -
(1) 10 kg (1) 5 kg (2) 2 kg (1) 1 kg (1) 500 g (2) 200 g (1) 100 g (1) 50 g (2) 20 g (1) 10 g (1) 5 g (2) 2 g (1) 1 g (1) 500 mg (2) 200 mg (1) 100 mg (1) 50 mg (2) 20 mg (1) 10 mg (1) 5 mg (2) 2 mg (1) 1 mg	(1) 10 kg (1) 5 kg (2) 2 kg (1) 1 kg (1) 500 g (2) 200 g (1) 100 g (1) 50 g (2) 20 g (1) 10 g (1) 5 g (2) 2 g (1) 1 g (1) 500 mg (2) 200 mg (1) 100 mg	(1) 10 kg (1) 5 kg (2) 2 kg (1) 1 kg (1) 500 g (2) 200 g (1) 100 g (1) 50 g (2) 20 g (1) 10 g (1) 5 g (2) 2 g (1) 1 g	(1) 10 kg (1) 5 kg (2) 2 kg (1) 1 kg (1) 500 g (2) 200 g (1) 100 g	(1) 10 kg (1) 5 kg (2) 2 kg (1) 1 kg
29 pcs. 21.1111 kg set wt.	21 pcs. 21.11105 kg	17 pcs. 21.111 kg set wt.	9 pcs. 21 kg set wt.	5 pcs. 20 kg set wt.

ASTM
PRECISION

OIML
PRECISION

BALANCE
CALIBRATION

STAINLESS
FIELD WEIGHTS

CAST IRON
FIELD WEIGHTS

ASTM
SPECIALTY

ACCESSORIES

Accessories

Main Cases		
Class M1	Part #	Price
Set Range		
10 kg - 1 mg	Consult	Consult
10 kg - 1 g	200297	\$585.00
Secondary Case		
Set Range	Part #	Price
100 g - 1 mg	34697	\$225.00

Description	Part #	Price
Statement of Accuracy	36092	\$47.50
Weight glove, white cotton	11714	\$6.75
Tweezer	11711	\$5.00
Premium tweezer	152414	\$43.00
Serial number	25836	\$17.00
Leaf weight cover	11755	\$43.00
Weight forceps, plastic	50035	\$43.00
Tong assembly 1 kg - 200 g	50000	\$74.00
Lifter, 5 kg and 2 kg	50037	\$54.00

MASS REFERENCE STANDARDS / METRIC SETS

RANGE: 20 kg

Class E2 Polished Finish

Statement of Accuracy not available.

Certificate

Set Range	Part #	Price	Accredited
20 kg - 1mg	65210	\$13,650.00	Included
20 kg - 100 mg	96416	\$13,275.00	Included
20 kg - 1g	96414	\$12,875.00	Included
20 kg - 100 g	96417	\$11,800.00	Included
20 kg - 1kg	96418	\$10,500.00	Included

Class F1 Polished Finish**Optional Certificate**

Set Range	Part #	Price	Accredited	Non-accredited
20 kg - 1mg	65211	\$10,650.00	\$1,680.00	\$1,025.00
20 kg - 100 mg	96428	\$7,050.00	\$1,445.00	\$885.00
20 kg - 1g	96425	\$10,350.00	\$1,285.00	\$760.00
20 kg - 100 g	96426	\$9,850.00	\$975.00	\$500.00
20 kg - 1kg	96427	\$9,075.00	\$645.00	\$340.00

Class F2 Polished Finish**Optional Certificate**

Set Range	Part #	Price	Accredited	Non-accredited
20 kg - 1mg	65212	\$9,475.00	\$1,680.00	\$1,025.00
20 kg - 100 mg	96447	\$9,325.00	\$1,445.00	\$885.00
20 kg - 1g	96441	\$9,225.00	\$1,285.00	\$760.00
20 kg - 100 g	96442	\$8,775.00	\$975.00	\$500.00
20 kg - 1kg	96443	\$8,075.00	\$645.00	\$340.00

Replacement Cases

Main Cases		
Class E2		
Set Range	Part #	Price
20 kg - 1mg	65219	\$2,330.00
20 kg - 100 mg	65219	\$2,330.00
20 kg - 1g	65219	\$2,330.00
20 kg - 100 g	65219	\$2,330.00
20 kg - 1kg	65219	\$2,330.00

Main Cases		
Class F1		
Set Range	Part #	Price
20 kg - 1mg	65219	\$2,330.00
20 kg - 100 mg	65219	\$2,330.00
20 kg - 1g	65219	\$2,330.00
20 kg - 100 g	65219	\$2,330.00
20 kg - 1kg	65219	\$2,330.00

Main Cases		
Class F2		
Set Range	Part #	Price
20 kg - 1mg	65219	\$2,330.00
20 kg - 100 mg	65219	\$2,330.00
20 kg - 1g	65219	\$2,330.00
20 kg - 100 g	65219	\$2,330.00
20 kg - 1kg	65219	\$2,330.00

Secondary Case		
Set Range	Part #	Price
100 g - 1mg	34697	\$225.00

Weight Set Contents

20 kg - 1 mg		20 kg - 100 mg		20 kg - 1 g		20 kg - 100 g		20 kg - 1 kg	
65210	Class E2	96416	Class E2	96414	Class E2	96417	Class E2	96418	Class E2
65211	Class F1	96428	Class F1	96425	Class F1	96426	Class F1	96427	Class F1
65212	Class F2	96447	Class F2	96441	Class F2	96442	Class F2	96443	Class F2
(1) 20 kg		(1) 20 kg		(1) 20 kg		(1) 20 kg		(1) 20 kg	
(1) 10 kg		(1) 10 kg		(1) 10 kg		(1) 10 kg		(1) 10 kg	
(1) 5 kg		(1) 5 kg		(1) 5 kg		(1) 5 kg		(1) 5 kg	
(2) 2 kg		(2) 2 kg		(2) 2 kg		(2) 2 kg		(2) 2 kg	
(1) 1 kg		(1) 1 kg		(1) 1 kg		(1) 1 kg		(1) 1 kg	
(1) 500 g		(1) 500 g		(1) 500 g		(1) 500 g			
(2) 200 g		(2) 200 g		(2) 200 g		(2) 200 g			
(1) 100 g		(1) 100 g		(1) 100 g		(1) 100 g			
(1) 50 g		(1) 50 g		(1) 50 g					
(2) 20 g		(2) 20 g		(2) 20 g					
(1) 10 g		(1) 10 g		(1) 10 g					
(1) 5 g		(1) 5 g		(1) 5 g					
(2) 2 g		(2) 2 g		(2) 2 g					
(1) 1 g		(1) 1 g		(1) 1 g					
(1) 500 mg		(1) 500 mg							
(2) 200 mg		(2) 200 mg							
(1) 100 mg		(1) 100 mg							
(1) 50 mg									
(2) 20 mg									
(1) 10 mg									
(1) 5 mg									
(2) 2 mg									
(1) 1 mg									
30 pcs. 41.1111 kg set wt.		22 pcs. 41.1105 kg set wt.		18 pcs. 41.111 kg set wt.		10 pcs. 41 kg set wt.		6 pcs. 40 kg set wt.	

Accessories

Description	Part #	Price
Statement of Accuracy	36092	\$47.50
Weight glove, white cotton	11714	\$6.75
Tweezer	11711	\$5.00
Premium tweezer	152414	\$43.00
Serial number	25836	\$17.00
Leaf weight cover	11755	\$43.00
Weight forceps, plastic	50035	\$43.00
Tong assembly 1 kg - 200 g	50000	\$74.00
Lifter, 5 kg and 2 kg	50037	\$54.00

ASTM
PRECISION

OIML
PRECISION

BALANCE
CALIBRATION

STAINLESS
FIELD WEIGHTS

CAST IRON
FIELD WEIGHTS

ASTM
SPECIALTY

ACCESSORIES

ASTM Balance Calibration Weights

Applications:

Calibrating Class I and II balances
ASTM Class 4, 5 and 6 weights
Tolerance checking or verification
of balances

Styles Available:

Cylindrical
Grip-handle

Classes Available:

Class 1 to 2 polished finish
Class 3 to 4 satin finish
Class 1 to 7 manufactured in accordance with
ASTM E617 specification and tolerances

Product Configuration:

Single weight
Single weight kit: includes weight, case
and glove or appropriate lifting device

Features:

Nominal value marked on weights
Serial numbers may be stamped or
laser marked on weights (Class 2 to 4)
Sealing cavity for adjusting material
in 100 g or larger weights
Density 7.84 g/cm³





Metric Single Weight with Case (Kits)

84 Range: 5 kg – 10 g

Metric Single Weights Grip-handle

86 Range: 30 kg – 5 kg

Metric Single Weights Cylindrical

87 Range: 5 kg – 10 g

Avoirdupois Single Weights Grip-handle

88 Range: 50 lb – 10 lb

Avoirdupois Single Weights Cylindrical

89 Range: 10 lb – 0.05 lb

BALANCE CALIBRATION WEIGHTS / METRIC SINGLE WEIGHT WITH CASE (KIT)

RANGE: 5 kg – 10 g

Class 3 Satin Finish

Weight	Kit Part #	Price
5 kg	13179	\$575.00
4 kg	13177	\$550.00
3 kg	13175	\$310.00
2 kg	13173	\$215.00
1,500 g	13206	\$205.00
1,000 g	13192	\$175.00
600 g	13204	\$195.00
500 g	13171	\$150.00
400 g	13189	\$150.00
300 g	13187	\$130.00
200 g	13169	\$130.00
160 g	13202	\$130.00
150 g	13200	\$115.00
100 g	13167	\$110.00
50 g	13185	\$93.00
30 g	13183	\$93.00
20 g	13181	\$93.00
10 g	13165	\$93.00

Optional Certificate

Accredited	Non-Accredited
\$145.00	\$80.00
\$145.00	\$80.00
\$145.00	\$80.00
\$145.00	\$80.00
\$145.00	\$80.00
\$125.00	\$60.00
\$125.00	\$60.00
\$125.00	\$60.00
\$125.00	\$60.00
\$125.00	\$60.00
\$125.00	\$60.00
\$125.00	\$60.00
\$125.00	\$60.00
\$55.00	\$45.00
\$55.00	\$45.00
\$55.00	\$45.00
\$55.00	\$45.00
\$55.00	\$45.00



Case for 4 kg and 5 kg only

Class 4 Satin Finish

Weight	Kit Part #	Price
5 kg	13282	\$560.00
4 kg	13280	\$525.00
3 kg	13278	\$305.00
2 kg	13276	\$200.00
1,500 g	13309	\$195.00
1,000 g	13295	\$175.00
600 g	13307	\$185.00
500 g	13274	\$140.00
400 g	13292	\$135.00
300 g	13290	\$125.00
200 g	13272	\$120.00
160 g	13305	\$125.00
150 g	13303	\$110.00
100 g	13270	\$93.00
50 g	13288	\$93.00
30 g	13286	\$85.00
20 g	13284	\$85.00
10 g	13268	\$85.00

Optional Certificate

Accredited
\$75.00
\$75.00
\$75.00
\$75.00
\$75.00
\$55.00
\$55.00
\$55.00
\$55.00
\$55.00
\$55.00
\$55.00
\$55.00
\$40.00
\$40.00
\$40.00
\$40.00



Kits Include a Single Weight with Case and Glove

Replacement Cases

Main Cases		
Class 3 and 4		
Nominal Value	Part #	Price
5 kg	197476	\$225.00
4 kg	197475	\$225.00
3 kg	190273	\$38.50
2 kg	190268	\$38.50
1,500 g	190270	\$38.50
1,000 g	190259	\$38.50
600 g	189714	\$38.50
500 g	189712	\$38.50
400 g	189709	\$38.50

Main Cases		
Class 3 and 4		
Nominal Value	Part #	Price
300 g	189643	\$38.50
200 g	194185	\$36.50
160 g	189634	\$38.50
150 g	189633	\$38.50
100 g	189567	\$42.00
50 g	189506	\$42.00
30 g	189505	\$42.00
20 g	189482	\$42.00
10 g	189475	\$42.00

Accessories

Description	Part #	Price
Statement of Accuracy	36092	\$47.50
Weight glove, white cotton	11714	\$6.75
Vinyl glove	11773	\$3.25
Serial number	25836	\$17.00

ASTM
PRECISION

OIML
PRECISION

BALANCE
CALIBRATION

STAINLESS
FIELD WEIGHTS

CAST IRON
FIELD WEIGHTS

SPECIALTY

ACCESSORIES

BALANCE CALIBRATION WEIGHTS / METRIC SINGLE WEIGHTS

RANGE: 30 kg – 5 kg

Class 1 Polished Finish
Grip-handle**Optional Certificate**

Weight	Part #	Price	Accredited	Non-Accredited
30 kg	12996	\$2,170.00	\$390.00	\$85.00
25 kg	12995	\$1,870.00	\$145.00	\$80.00
24 kg	12994	\$1,810.00	\$145.00	\$80.00
20 kg	12993	\$1,640.00	\$145.00	\$80.00
16 kg	12992	\$1,450.00	\$145.00	\$80.00
10 kg	12991	\$1,040.00	\$145.00	\$80.00
8 kg	12990	\$1,020.00	\$145.00	\$80.00
5 kg	12989	\$770.00	\$145.00	\$80.00

Class 2 Polished Finish
Grip-handle**Optional Certificate**

Weight	Part #	Price	Accredited	Non-Accredited
30 kg	13114	\$1,900.00	\$390.00	\$85.00
25 kg	13113	\$1,600.00	\$145.00	\$80.00
24 kg	13112	\$1,580.00	\$145.00	\$80.00
20 kg	13111	\$1,410.00	\$145.00	\$80.00
16 kg	13110	\$1,360.00	\$145.00	\$80.00
10 kg	13109	\$950.00	\$145.00	\$80.00
8 kg	13108	\$930.00	\$145.00	\$80.00
5 kg	13107	\$615.00	\$145.00	\$80.00

Class 3 Satin Finish
Grip-handle**Optional Certificate**

Weight	Part #	Price	Accredited	Non-Accredited
30 kg	13217	\$1,720.00	\$390.00	\$85.00
25 kg	13216	\$1,490.00	\$145.00	\$80.00
24 kg	13215	\$1,450.00	\$145.00	\$80.00
20 kg	13214	\$1,270.00	\$145.00	\$80.00
16 kg	13213	\$1,090.00	\$145.00	\$80.00
10 kg	13212	\$860.00	\$145.00	\$80.00
8 kg	13211	\$800.00	\$145.00	\$80.00
5 kg	13210	\$600.00	\$145.00	\$80.00

Class 4 Satin Finish
Grip-handle**Optional Certificate**

Weight	Part #	Price	Accredited
30 kg	13320	\$1,590.00	\$80.00
25 kg	13319	\$1,350.00	\$75.00
24 kg	13318	\$1,280.00	\$75.00
20 kg	13317	\$1,100.00	\$75.00
16 kg	13316	\$970.00	\$75.00
10 kg	13315	\$765.00	\$75.00
8 kg	13314	\$755.00	\$75.00
5 kg	13313	\$530.00	\$75.00



Replacement Cases

Main Cases		
Class 1, 2, 3 and 4		
Nominal Value	Part #	Price
30 kg	Consult	Consult
25 kg	Consult	Consult
24 kg	Consult	Consult
20 kg	Consult	Consult
16 kg	Consult	Consult
10 kg	Consult	Consult
8 kg	Consult	Consult
5 kg	Consult	Consult

BALANCE CALIBRATION WEIGHTS / METRIC SINGLE WEIGHTS

RANGE: 5 kg – 10 g

Class 1 Polished Finish Cylindrical

Weight	Part #	Price
5 kg	12959	\$725.00
4 kg	12957	\$630.00
3 kg	12955	\$375.00
2 kg	12953	\$215.00
1,500 g	12986	\$190.00
1,000 g	12972	\$160.00
600 g	12984	\$175.00
500 g	12951	\$135.00
400 g	12969	\$130.00
300 g	12967	\$125.00
200 g	12949	\$125.00
160 g	12982	\$135.00
150 g	12980	\$93.00
100 g	12947	\$85.00
50 g	12965	\$79.00
30 g	12963	\$79.00
20 g	12961	\$79.00
10 g	12945	\$79.00

Optional Certificate

Accredited	Non-Accredited
\$145.00	\$80.00
\$145.00	\$80.00
\$145.00	\$80.00
\$145.00	\$80.00
\$145.00	\$80.00
\$125.00	\$60.00
\$125.00	\$60.00
\$125.00	\$60.00
\$125.00	\$60.00
\$125.00	\$60.00
\$125.00	\$60.00
\$125.00	\$60.00
\$125.00	\$60.00
\$125.00	\$60.00
\$55.00	\$45.00
\$55.00	\$45.00
\$55.00	\$45.00
\$55.00	\$45.00

Class 3 Satin Finish Cylindrical

Weight	Part #	Price
5 kg	13180	\$550.00
4 kg	13178	\$520.00
3 kg	13176	\$285.00
2 kg	13174	\$185.00
1,500 g	13207	\$185.00
1,000 g	13193	\$150.00
600 g	13205	\$155.00
500 g	13172	\$120.00
400 g	13190	\$120.00
300 g	13188	\$110.00
200 g	13170	\$100.00
160 g	13203	\$125.00
150 g	13201	\$79.00
100 g	13168	\$73.00
50 g	13186	\$68.00
30 g	13184	\$68.00
20 g	13182	\$68.00
10 g	13166	\$68.00

Optional Certificate

Accredited	Non-Accredited
\$145.00	\$80.00
\$145.00	\$80.00
\$145.00	\$80.00
\$145.00	\$80.00
\$145.00	\$80.00
\$125.00	\$60.00
\$125.00	\$60.00
\$125.00	\$60.00
\$125.00	\$60.00
\$125.00	\$60.00
\$125.00	\$60.00
\$125.00	\$60.00
\$125.00	\$60.00
\$125.00	\$60.00
\$55.00	\$45.00
\$55.00	\$45.00
\$55.00	\$45.00
\$55.00	\$45.00

Class 2 Polished Finish Cylindrical

Weight	Part #	Price
5 kg	13077	\$580.00
4 kg	13075	\$570.00
3 kg	13073	\$295.00
2 kg	13071	\$195.00
1,500 g	13104	\$190.00
1,000 g	13090	\$155.00
600 g	13102	\$160.00
500 g	13069	\$130.00
400 g	13087	\$125.00
300 g	13085	\$115.00
200 g	13067	\$115.00
160 g	13100	\$125.00
150 g	13098	\$85.00
100 g	13065	\$79.00
50 g	13083	\$73.00
30 g	13081	\$73.00
20 g	13079	\$73.00
10 g	13063	\$73.00

Optional Certificate

Accredited	Non-Accredited
\$145.00	\$80.00
\$145.00	\$80.00
\$145.00	\$80.00
\$145.00	\$80.00
\$145.00	\$80.00
\$125.00	\$60.00
\$125.00	\$60.00
\$125.00	\$60.00
\$125.00	\$60.00
\$125.00	\$60.00
\$125.00	\$60.00
\$125.00	\$60.00
\$125.00	\$60.00
\$55.00	\$45.00
\$55.00	\$45.00
\$55.00	\$45.00
\$55.00	\$45.00

Class 4 Satin Finish Cylindrical

Weight	Part #	Price
5 kg	13283	\$480.00
4 kg	13281	\$450.00
3 kg	13279	\$280.00
2 kg	13277	\$175.00
1,500 g	13310	\$170.00
1,000 g	13296	\$150.00
600 g	13308	\$150.00
500 g	13275	\$115.00
400 g	13293	\$115.00
300 g	13291	\$100.00
200 g	13273	\$93.00
160 g	13306	\$120.00
150 g	13304	\$66.00
100 g	13271	\$68.00
50 g	13289	\$68.00
30 g	13287	\$68.00
20 g	13285	\$68.00
10 g	13269	\$68.00

Optional Certificate

Accredited
\$75.00
\$75.00
\$75.00
\$75.00
\$75.00
\$55.00
\$55.00
\$55.00
\$55.00
\$55.00
\$55.00
\$55.00
\$55.00
\$40.00
\$40.00
\$40.00
\$40.00

Replacement Cases

Main Cases		
Class 1, 2, 3 and 4		
Nominal Value	Part #	Price
5 kg	197476	\$225.00
4 kg	197475	\$225.00
3 kg	190273	\$38.50
2 kg	190268	\$38.50
1,500 g	190270	\$38.50
1,000 g	190259	\$38.50
600 g	189714	\$38.50
500 g	189712	\$38.50
400 g	189709	\$38.50

Main Cases		
Class 1, 2, 3 and 4		
Nominal Value	Part #	Price
300 g	189643	\$38.50
200 g	194185	\$36.50
160 g	189634	\$38.50
150 g	189633	\$38.50
100 g	189567	\$42.00
50 g	189506	\$42.00
30 g	189505	\$42.00
20 g	189482	\$42.00
10 g	189475	\$42.00



ASTM
PRECISION

OIML
PRECISION

BALANCE
CALIBRATION

STAINLESS
FIELD WEIGHTS

CAST IRON
FIELD WEIGHTS

SPECIALTY

ACCESSORIES

BALANCE CALIBRATION WEIGHTS / AVOIRDUPOIS SINGLE WEIGHTS

RANGE: 50 lb – 10 lb

Class 1 Polished Finish
Grip-handle**Optional Certificate**

Weight	Part #	Price	Accredited	Non-Accredited
50 lb	13038	\$1,870.00	\$285.00	\$85.00
30 lb	13037	\$1,460.00	\$130.00	\$85.00
25 lb	13036	\$1,040.00	\$130.00	\$85.00
20 lb	13035	\$1,040.00	\$130.00	\$85.00
10 lb	13034	\$755.00	\$130.00	\$85.00

Class 2 Polished Finish
Grip-handle**Optional Certificate**

Weight	Part #	Price	Accredited	Non-Accredited
50 lb	13155	\$1,600.00	\$285.00	\$85.00
30 lb	13154	\$1,180.00	\$130.00	\$85.00
25 lb	13153	\$920.00	\$130.00	\$85.00
20 lb	13152	\$885.00	\$130.00	\$85.00
10 lb	13151	\$615.00	\$130.00	\$85.00

Class 3 Satin Finish
Grip-handle**Optional Certificate**

Weight	Part #	Price	Accredited	Non-Accredited
50 lb	13258	\$1,500.00	\$285.00	\$85.00
30 lb	13257	\$1,040.00	\$130.00	\$85.00
25 lb	13256	\$795.00	\$130.00	\$85.00
20 lb	13255	\$775.00	\$130.00	\$85.00
10 lb	13254	\$605.00	\$130.00	\$85.00

Class 4 Satin Finish
Grip-handle**Optional Certificate**

Weight	Part #	Price	Accredited
50 lb	13361	\$1,480.00	\$80.00
30 lb	13360	\$985.00	\$80.00
25 lb	13359	\$725.00	\$80.00
20 lb	13358	\$645.00	\$80.00
10 lb	13357	\$495.00	\$80.00



Replacement Cases

Main Cases		
Class 1, 2, 3 and 4		
Nominal Value	Part #	Price
50 lb	Consult	Consult
30 lb	Consult	Consult
25 lb	Consult	Consult
20 lb	Consult	Consult
10 lb	Consult	Consult

BALANCE CALIBRATION WEIGHTS / AVOIRDUPOIS SINGLE WEIGHTS

RANGE: 10 lb – 0.05 lb

Class 1 Polished Finish
Cylindrical

Weight	Part #	Price
10 lb	13022	\$735.00
5 lb	13020	\$375.00
4 lb	13018	\$215.00
3 lb	13016	\$190.00
2 lb	13014	\$170.00
1 lb	13012	\$135.00
8 oz	13010	\$115.00
4 oz	13008	\$110.00
2 oz	13006	\$100.00
1 oz	13004	\$100.00
1/2 oz	13002	\$93.00
0.5 lb	13033	\$115.00
0.2 lb	13025	\$110.00
0.1 lb	13027	\$100.00
0.05 lb	13029	\$93.00

Optional Certificate

Accredited	Non-Accredited
\$130.00	\$85.00
\$130.00	\$85.00
\$130.00	\$85.00
\$130.00	\$85.00
\$105.00	\$70.00
\$105.00	\$70.00
\$55.00	\$45.00
\$55.00	\$45.00
\$55.00	\$45.00
\$55.00	\$45.00
\$55.00	\$45.00
\$55.00	\$45.00
\$55.00	\$45.00
\$55.00	\$45.00
\$55.00	\$45.00
\$55.00	\$45.00
\$55.00	\$45.00

Class 3 Satin Finish
Cylindrical

Weight	Part #	Price
10 lb	13242	\$520.00
5 lb	13240	\$295.00
4 lb	13238	\$195.00
3 lb	13236	\$185.00
2 lb	13234	\$150.00
1 lb	13232	\$125.00
8 oz	13230	\$100.00
4 oz	13228	\$84.00
2 oz	13226	\$79.00
1 oz	13224	\$73.00
1/2 oz	13222	\$73.00
0.5 lb	13253	\$100.00
0.2 lb	13245	\$68.00
0.1 lb	13247	\$68.00
0.05 lb	13249	\$68.00

Optional Certificate

Accredited	Non-Accredited
\$130.00	\$85.00
\$130.00	\$85.00
\$130.00	\$85.00
\$130.00	\$85.00
\$105.00	\$70.00
\$105.00	\$70.00
\$55.00	\$45.00
\$55.00	\$45.00
\$55.00	\$45.00
\$55.00	\$45.00
\$55.00	\$45.00
\$55.00	\$45.00
\$55.00	\$45.00
\$55.00	\$45.00
\$55.00	\$45.00
\$55.00	\$45.00
\$55.00	\$45.00

Class 2 Polished Finish
Cylindrical

Weight	Part #	Price
10 lb	13139	\$575.00
5 lb	13137	\$310.00
4 lb	13135	\$200.00
3 lb	13133	\$185.00
2 lb	13131	\$155.00
1 lb	13129	\$130.00
8 oz	13127	\$110.00
4 oz	13125	\$84.00
2 oz	13123	\$79.00
1 oz	13121	\$79.00
1/2 oz	13119	\$79.00
0.5 lb	13150	\$100.00
0.2 lb	13142	\$79.00
0.1 lb	13144	\$79.00
0.05 lb	13146	\$79.00

Optional Certificate

Accredited	Non-Accredited
\$130.00	\$85.00
\$130.00	\$85.00
\$130.00	\$85.00
\$130.00	\$85.00
\$105.00	\$70.00
\$105.00	\$70.00
\$55.00	\$45.00
\$55.00	\$45.00
\$55.00	\$45.00
\$55.00	\$45.00
\$55.00	\$45.00
\$55.00	\$45.00
\$55.00	\$45.00
\$55.00	\$45.00
\$55.00	\$45.00
\$55.00	\$45.00
\$55.00	\$45.00

Class 4 Satin Finish
Cylindrical

Weight	Part #	Price
10 lb	13345	\$495.00
5 lb	13343	\$285.00
4 lb	13341	\$190.00
3 lb	13339	\$175.00
2 lb	13337	\$150.00
1 lb	13335	\$120.00
8 oz	13333	\$93.00
4 oz	13331	\$79.00
2 oz	13329	\$73.00
1 oz	13327	\$68.00
1/2 oz	13325	\$68.00
0.5 lb	13356	\$93.00
0.2 lb	13348	\$68.00
0.1 lb	13350	\$68.00
0.05 lb	13352	\$68.00

Optional Certificate

Accredited
\$80.00
\$80.00
\$80.00
\$80.00
\$65.00
\$65.00
\$40.00
\$40.00
\$40.00
\$40.00
\$40.00
\$40.00
\$40.00
\$40.00
\$40.00
\$40.00

ASTM
PRECISION

OIML
PRECISION

BALANCE
CALIBRATION

STAINLESS
FIELD WEIGHTS

CAST IRON
FIELD WEIGHTS

SPECIALTY

ACCESSORIES

Replacement Cases

Main Cases		
Class 1, 2, 3 and 4		
Nominal Value	Part #	Price
10 lb	197473	\$225.00
5 lb	190269	\$38.50
4 lb	190267	\$38.50
3 lb	190263	\$38.50
2 lb	190260	\$38.50
1 lb	189710	\$38.50
8 oz	189635	\$38.50
4 oz	189568	\$42.00

Main Cases		
Class 1, 2, 3 and 4		
Nominal Value	Part #	Price
2 oz	189565	\$42.00
1 oz	189484	\$42.00
1/2 oz	189476	\$42.00
0.5 lb	189635	\$38.50
0.2 lb	189565	\$42.00
0.1 lb	189507	\$42.00
0.05 lb	189483	\$42.00



BALANCE CALIBRATION WEIGHTS / AVOIRDUPOIS SINGLE WEIGHT WITH CASE (KIT)**RANGE: 10 lb – 0.05 lb****Class 1** Polished Finish

Weight	Part #	Price
10 lb	13021	\$755.00
5 lb	13019	\$400.00
4 lb	13017	\$235.00
3 lb	13015	\$215.00
2 lb	13013	\$195.00
1 lb	13011	\$160.00
8 oz	13009	\$135.00
4 oz	13007	\$130.00
2 oz	13005	\$125.00
1 oz	13003	\$125.00
1/2 oz	13001	\$125.00
0.5 lb	13032	\$135.00
0.2 lb	13024	\$130.00
0.1 lb	13026	\$125.00
0.05 lb	13028	\$125.00

Optional Certificate

Accredited	Non-Accredited
\$130.00	\$85.00
\$130.00	\$85.00
\$130.00	\$85.00
\$130.00	\$85.00
\$105.00	\$70.00
\$105.00	\$70.00
\$55.00	\$45.00
\$55.00	\$45.00
\$55.00	\$45.00
\$55.00	\$45.00
\$55.00	\$45.00
\$55.00	\$45.00
\$55.00	\$45.00
\$55.00	\$45.00
\$55.00	\$45.00
\$55.00	\$45.00
\$55.00	\$45.00

Class 2 Polished Finish

Weight	Part #	Price
10 lb	13138	\$605.00
5 lb	13136	\$320.00
4 lb	13134	\$230.00
3 lb	13132	\$215.00
2 lb	13130	\$175.00
1 lb	13128	\$160.00
8 oz	13126	\$130.00
4 oz	13124	\$110.00
2 oz	13122	\$110.00
1 oz	13120	\$110.00
1/2 oz	13118	\$110.00
0.5 lb	13149	\$130.00
0.2 lb	13141	\$110.00
0.1 lb	13143	\$110.00
0.05 lb	13145	\$110.00

Optional Certificate

Accredited	Non-Accredited
\$130.00	\$85.00
\$130.00	\$85.00
\$130.00	\$85.00
\$130.00	\$85.00
\$105.00	\$70.00
\$105.00	\$70.00
\$55.00	\$45.00
\$55.00	\$45.00
\$55.00	\$45.00
\$55.00	\$45.00
\$55.00	\$45.00
\$55.00	\$45.00
\$55.00	\$45.00
\$55.00	\$45.00
\$55.00	\$45.00
\$55.00	\$45.00



*Kits Include a Single Weight
with Case and Glove*

Replacement Cases

Main Cases		
Class 1 and 2		
Nominal Value	Part #	Price
10 lb	197473	\$225.00
5 lb	190269	\$38.50
4 lb	190267	\$38.50
3 lb	190263	\$38.50
2 lb	190260	\$38.50
1 lb	189710	\$38.50
8 oz	189635	\$38.50
4 oz	189568	\$42.00
2 oz	189565	\$42.00

Main Cases		
Class 1 and 2		
Nominal Value	Part #	Price
1 oz	189484	\$42.00
1/2 oz	189476	\$42.00
0.5 lb	189635	\$38.50
0.2 lb	190126	\$38.50
0.1 lb	189507	\$42.00
0.05 lb	189483	\$42.00

Accessories

Description	Part #	Price
Statement of Accuracy	36092	\$47.50
Weight glove, white cotton	11714	\$6.75
Vinyl glove	11773	\$3.25
Serial number	25836	\$17.00

BALANCE CALIBRATION WEIGHTS / AVOIRDUPOIS SINGLE WEIGHT WITH CASE (KIT)

RANGE: 10 lb – 0.05 lb

Class 3 Satin Finish

Weight	Part #	Price
10 lb	13241	\$545.00
5 lb	13239	\$320.00
4 lb	13237	\$230.00
3 lb	13235	\$215.00
2 lb	13233	\$175.00
1 lb	13231	\$150.00
8 oz	13229	\$130.00
4 oz	13227	\$110.00
2 oz	13225	\$110.00
1 oz	13223	\$110.00
1/2 oz	13221	\$110.00
0.5 lb	13252	\$130.00
0.2 lb	13244	\$100.00
0.1 lb	13246	\$100.00
0.05 lb	13248	\$100.00

Optional Certificate

Accredited	Non-Accredited
\$130.00	\$85.00
\$130.00	\$85.00
\$130.00	\$85.00
\$130.00	\$85.00
\$105.00	\$70.00
\$105.00	\$70.00
\$55.00	\$45.00
\$55.00	\$45.00
\$55.00	\$45.00
\$55.00	\$45.00
\$55.00	\$45.00
\$55.00	\$45.00
\$55.00	\$45.00
\$55.00	\$45.00
\$55.00	\$45.00
\$55.00	\$45.00
\$55.00	\$45.00

Class 4 Satin Finish

Weight	Part #	Price
10 lb	13344	\$525.00
5 lb	13342	\$310.00
4 lb	13340	\$220.00
3 lb	13338	\$200.00
2 lb	13336	\$175.00
1 lb	13334	\$140.00
8 oz	13332	\$120.00
4 oz	13330	\$110.00
2 oz	13328	\$110.00
1 oz	13326	\$100.00
1/2 oz	13324	\$100.00
0.5 lb	13355	\$125.00
0.2 lb	13347	\$93.00
0.1 lb	13349	\$93.00
0.05 lb	13351	\$93.00

Optional Certificate

Accredited
\$80.00
\$80.00
\$80.00
\$80.00
\$65.00
\$65.00
\$40.00
\$40.00
\$40.00
\$40.00
\$40.00
\$40.00
\$40.00
\$40.00
\$40.00
\$40.00
\$40.00



Kits Include a Single Weight with Case and Glove

ASTM
PRECISION

OIML
PRECISION

BALANCE
CALIBRATION

STAINLESS
FIELD WEIGHTS

CAST IRON
FIELD WEIGHTS

SPECIALTY

ACCESSORIES

Replacement Cases

Main Cases		
Class 3 and 4		
Nominal Value	Part #	Price
10 lb	197473	\$225.00
5 lb	190269	\$38.50
4 lb	190267	\$38.50
3 lb	190263	\$38.50
2 lb	190260	\$38.50
1 lb	189710	\$38.50
8 oz	189635	\$38.50
4 oz	189568	\$42.00
2 oz	189565	\$42.00

Main Cases		
Class 3 and 4		
Nominal Value	Part #	Price
1 oz	189484	\$42.00
1/2 oz	189476	\$42.00
0.5 lb	189635	\$38.50
0.2 lb	190126	\$38.50
0.1 lb	189507	\$42.00
0.05 lb	189483	\$42.00

Accessories

Description	Part #	Price
Statement of Accuracy	36092	\$47.50
Weight glove, white cotton	11714	\$6.75
Vinyl glove	11773	\$3.25
Serial number	25836	\$17.00

5

ASTM Stainless Steel Field Weights

Applications:

Field standards for Class III scales or balances

Testing non-classified scale equipment

Tolerance checking

Designs Available:

Cylindrical

Grip-handle

Product Configuration:

Single weight

Weight set includes weights, case and handling equipment

Weight set configuration: 5-2-2-1 or 5-3-2-1

Example: (1) 50 g, (2) 20 g and (1) 10 g or (1) 50 g, (1) 30 g, (1) 20 g and (1) 10 g

Appropriate lifting device, tweezer and/or glove

Features:

Stainless steel weights designed to meet NIST Handbook 44 and 105-1

ASTM Class 5 tolerance

Sealing cavity for adjustment on most weights

Serial numbers may be stamped on weights (optional)

Nominal value marked on weights



Metric Single Weights

92 Range: 30 kg – 1 mg

Avoirdupois Single Weights

93 Range: 50 lb – 10 lb

94 Range: 10 lb – 0.001 lb

Metric Sets

95 Range: 5 g and 50 g

96 Range: 100 g

97 Range: 500 g

98 Range: 1 kg

99 Range: 2 kg

100 Range: 5 kg

Avoirdupois Sets

101 Range: 4 oz

102 Range: 1 lb

103 Range: 2 lb

104 Range: 5 lb

106 Range: 10 lb

STAINLESS STEEL / AVOIRDUPOIS SINGLE WEIGHTS

RANGE: 50 lb – 10 lb

ASTM

Class 5
Grip-handle

Optional Certificate

Weight	Part #	Height	Diameter	Price	Accredited
50 lb	12677	6-21/32 in (169 mm)	6 in (152 mm)	\$965.00	\$80.00
30 lb	12676	6-11/16 in (170 mm)	5 in (127 mm)	\$735.00	\$80.00
25 lb	12675	5-3/4 in (146 mm)	5 in (127 mm)	\$615.00	\$80.00
20 lb	12674	4-27/32 in (123 mm)	5 in (127 mm)	\$570.00	\$80.00
10 lb	12673	3-1/32 in (77 mm)	5 in (127 mm)	\$340.00	\$80.00



Accessories

Description	Part #	Price
Statement of Accuracy	36092	\$47.50
Serial number	25836	\$17.00

ASTM
PRECISION

OIML
PRECISION

BALANCE
CALIBRATION

STAINLESS
FIELD WEIGHTS

CAST IRON
FIELD WEIGHTS

ASTM
SPECIALTY

ACCESSORIES

STAINLESS STEEL / AVOIRDUPOIS SINGLE WEIGHTS

RANGE: 10 lb – 0.001 lb

ASTM

Class 5

Cylindrical

Weight	Part #	Height	Diameter	Price	Optional Certificate	Accredited
10 lb	12606	4-1/16 in (103 mm)	3-1/2 in (88 mm)	\$235.00		\$80.00
5 lb	12604	3-11/16 in (93 mm)	2-5/8 in (66 mm)	\$150.00		\$80.00
4 lb	12602	3-1/16 in (77 mm)	2-5/8 in (66 mm)	\$145.00		\$80.00
3 lb	12600	2-15/16 in (74 mm)	2-1/4 in (57 mm)	\$140.00		\$80.00
2 lb	12598	2-15/32 in (63 mm)	2 in (51 mm)	\$79.00		\$65.00
1 lb	12596	2-9/32 in (58 mm)	1-1/2 in (38 mm)	\$68.00		\$65.00
12 oz	12626	2-1/16 in (52 mm)	1-3/8 in (35 mm)	\$62.00		\$40.00
8 oz	12594	1-21/32 in (42 mm)	1-1/4 in (32 mm)	\$54.00		\$40.00
4 oz	12592	1-11/32 in (34 mm)	1 in (25 mm)	\$48.50		\$40.00
2 oz	12590	15/16 in (24 mm)	13/16 in (21 mm)	\$46.50		\$40.00
1 oz	12587	13/16 in (20 mm)	5/8 in (16 mm)	\$43.00		\$40.00
1/2 oz	12584	21/32 in (17 mm)	1/2 in (13 mm)	\$43.00		\$40.00
1/4 oz	12581	5/8 in (16 mm)	3/8 in (10 mm)	\$37.50		\$40.00
1/8 oz	12578	7/16 in (11 mm)	5/16 in (8 mm)	\$37.50		\$40.00
1/16 oz	12575	3/8 in (10 mm)	1/4 in (6 mm)	\$37.50		\$40.00
1/32 oz	12608	11/32 in (9 mm)	3/16 in (5 mm)	\$37.50		\$40.00
0.5 oz	12647	21/32 in (17 mm)	1/2 in (13 mm)	\$43.00		\$40.00
0.3 oz	12645	17/32 in (14 mm)	7/16 in (11 mm)	\$43.00		\$40.00
0.2 oz	12643	1/2 in (13 mm)	3/8 in (9 mm)	\$43.00		\$40.00
0.1 oz	12641	3/8 in (9 mm)	5/16 in (8 mm)	\$43.00		\$40.00
0.05 oz	12639	5/16 in (7 mm)	1/4 in (6 mm)	\$43.00		\$40.00
0.5 lb	12624	1-21/32 in (42 mm)	1 1/4 in (32 mm)	\$54.00		\$40.00
0.3 lb	12622	1-3/16 in (30 mm)	1 1/8 in (28 mm)	\$54.00		\$40.00
0.2 lb	12610	1-7/32 in (31 mm)	15/16 in (24 mm)	\$46.50		\$40.00
0.1 lb	12612	7/8 in (22 mm)	3/4 in (19 mm)	\$46.50		\$40.00
0.05 lb	12614	23/32 in (18 mm)	19/32 in (15 mm)	\$46.50		\$40.00
0.03 lb	12620	5/8 in (16 mm)	1/2 in (12 mm)	\$46.50		\$40.00
0.02 lb	12616	9/16 in (14 mm)	7/16 in (11 mm)	\$46.50		\$40.00
0.01 lb	12618	17/32 in (14 mm)	5/16 in (8 mm)	\$46.50		\$40.00
0.005 lb	198340	7/16 in (11 mm)	15/64 in (6 mm)	\$43.00		\$40.00
0.003 lb	198344	7/64 in (7 mm)	15/64 in (6 mm)	\$43.00		\$40.00
0.002 lb	198341	21/64 in (9 mm)	11/64 in (4 mm)	\$43.00		\$40.00
0.001 lb	198343	3/16 in (5 mm)	11/64 in (4 mm)	\$43.00		\$40.00



Replacement Cases

Main Cases		
Class 5		
Nominal Vaule	Part #	Price
10 lb	197473	\$225.00
5 lb	190269	\$38.50
4 lb	190267	\$38.50
3 lb	190263	\$38.50
2 lb	190260	\$38.50
1 lb	189710	\$38.50
12 oz	189636	\$38.50
8 oz	189635	\$38.50
4 oz	189567	\$42.00
2 oz	189565	\$42.00
1 oz	189484	\$42.00
1/2 oz	189476	\$42.00
1/4 oz	194054	\$40.00
1/8 oz	194032	\$40.00
1/16 oz	189234	\$42.00
1/32 oz	190126	\$38.50
0.5 oz	189476	\$42.00

Main Cases		
Class 5		
Nominal Vaule	Part #	Price
0.3 oz	189350	\$42.00
0.2 oz	194054	\$40.00
0.1 oz	194032	\$40.00
0.05 oz	189234	\$42.00
0.5 lb	189635	\$38.50
0.3 lb	189644	\$38.50
0.2 lb	190126	\$38.50
0.1 lb	189506	\$42.00
0.05 lb	190126	\$38.50
0.03 lb	189476	\$42.00
0.02 lb	189350	\$42.00
0.01 lb	194031	\$155.00
0.005 lb	Consult	Consult
0.003 lb	Consult	Consult
0.002 lb	Consult	Consult
0.001 lb	Consult	Consult

Accessories

Description	Part #	Price
Statement of Accuracy	36092	\$47.50
Serial number	25836	\$17.00

STAINLESS STEEL / METRIC SETS

RANGE: 5 g and 50 g

ASTM

Class 5

Optional Certificate

Set Range	Part #	Price	Accredited
5g - 1mg	12548	\$200.00	\$240.00
50g - 1mg	12504	\$250.00	\$475.00
50g - 10mg	12502	\$230.00	\$380.00
50g - 1g	12500	\$190.00	\$190.00
(2) 50g - 1mg	12550	\$365.00	\$475.00

Weight Set Contents

5g - 1mg	50g - 1mg	(2) 50g - 1mg	50g - 10mg	50g - 1g
12548	12504	12550	12502	12500
-	(1) 50g	(2) 50g	(1) 50g	(1) 50g
-	-	(1) 30g	-	-
-	(2) 20g	(1) 20g	(2) 20g	(2) 20g
-	(1) 10g	(1) 10g	(1) 10g	(1) 10g
(1) 5g	(1) 5g	(1) 5g	(1) 5g	(1) 5g
(1) 3g	-	(1) 3g	-	-
(1) 2g	(2) 2g	(1) 2g	(2) 2g	(2) 2g
(1) 1g	(1) 1g	(1) 1g	(1) 1g	(1) 1g
(1) 500mg	(1) 500mg	(1) 500mg	(1) 500mg	-
(1) 300mg	-	(1) 300mg	-	-
(1) 200mg	(2) 200mg	(1) 200mg	(2) 200mg	-
(1) 100mg	(1) 100mg	(1) 100mg	(1) 100mg	-
(1) 50mg	(1) 50mg	(1) 50mg	(1) 50mg	-
(1) 30mg	-	(1) 30mg	-	-
(1) 20mg	(2) 20mg	(1) 20mg	(2) 20mg	-
(1) 10mg	(1) 10mg	(1) 10mg	(1) 10mg	-
(1) 5mg	(1) 5mg	(1) 5mg	-	-
(1) 3mg	-	(1) 3mg	-	-
(1) 2mg	(2) 2mg	(1) 2mg	-	-
(1) 1mg	(1) 1mg	(1) 1mg	-	-
16 pcs. 12.221g set wt.	20 pcs. 111.11g set wt.	21 pcs. 172.221g set wt.	16 pcs. 111.1g set wt.	8 pcs. 110.000g set wt.



PN 12500 50 g to 1 g

Replacement Cases

Main Cases		
Class 5		
Set Range	Part #	Price
5g - 1mg	11510	\$37.50
50g - 1mg	11512	\$37.50
50g - 10mg	11512	\$37.50
50g - 1g	11512	\$37.50
(2) 50g - 1mg	11512	\$37.50

Inserts		
Class 5 (leaf weight cover not included)		
Set Range	Part #	Price
50g - 1mg	11517	\$37.50
50g - 10mg	11517	\$37.50
50g - 1g	11516	\$37.50

Accessories

Description	Part #	Price
Statement of Accuracy	36092	\$47.50
Leaf weight cover	11758	\$43.00
Tweezer	65640	\$21.00
Serial number	25836	\$17.00
Premium tweezer	152414	\$43.00

ASTM
PRECISION

OIML
PRECISION

BALANCE
CALIBRATION

STAINLESS
FIELD WEIGHTS

CAST IRON
FIELD WEIGHTS

ASTM
SPECIALTY

ACCESSORIES

ASTM
PRECISIONOIML
PRECISIONBALANCE
CALIBRATIONSTAINLESS
FIELD WEIGHTSCAST IRON
FIELD WEIGHTSASTM
SPECIALTY

ACCESSORIES

STAINLESS STEEL / METRIC SETS

RANGE: 100 g

ASTM

Class 5

Set Range	Part #	Price	Optional Certificate Accredited
100 g - 1 mg	12510	\$265.00	\$505.00
100 g - 10 mg	12508	\$255.00	\$395.00
100 g - 1 g	12506	\$230.00	\$215.00

Weight Set Contents

100 g - 1 mg	100 g - 10 mg	100 g - 1 g
12510	12508	12506
(1) 100 g	(1) 100 g	(1) 100 g
(1) 50 g	(1) 50 g	(1) 50 g
(2) 20 g	(2) 20 g	(2) 20 g
(1) 10 g	(1) 10 g	(1) 10 g
(1) 5 g	(1) 5 g	(1) 5 g
(2) 2 g	(2) 2 g	(2) 2 g
(1) 1 g	(1) 1 g	(1) 1 g
(1) 500 mg	(1) 500 mg	
(2) 200 mg	(2) 200 mg	
(1) 100 mg	(1) 100 mg	
(1) 50 mg	(1) 50 mg	
(2) 20 mg	(2) 20 mg	
(1) 10 mg	(1) 10 mg	
(1) 5 mg		
(2) 2 mg		
(1) 1 mg		
21 pcs. 211.11 g set wt.	17 pcs. 211.19 g set wt.	9 pcs. 210.000 g set wt.



PN 12506 100 g to 1 g

Replacement Cases

Main Cases		
Class 5		
Set Range	Part #	Price
100 g - 1 mg	11512	\$37.50
100 g - 10 mg	11512	\$37.50
100 g - 1 g	11512	\$37.50

Inserts		
Class 5 (leaf weight cover not included)		
Set Range	Part #	Price
100 g - 1 mg	11519	\$37.50
100 g - 10 mg	11519	\$37.50
100 g - 1 g	11518	\$37.50

Accessories

Description	Part #	Price
Statement of Accuracy	36092	\$47.50
Leaf weight cover	11758	\$43.00
Tweezer	65640	\$21.00
Serial number	25836	\$17.00
Premium tweezer	152414	\$43.00

RANGE: 500 g

ASTM

Class 5

Set Range	Part #	Price
500 g - 1mg	12516	\$490.00
500 g - 10 mg	12514	\$440.00
500 g - 1g	12512	\$390.00

Optional Certificate

Accredited
\$605.00
\$505.00
\$310.00

Weight Set Contents

500 g - 1mg	500 g - 10 mg	500 g - 1g
12516	12514	12512
(1) 500 g	(1) 500 g	(1) 500 g
(2) 200 g	(2) 200 g	(2) 200 g
(1) 100 g	(1) 100 g	(1) 100 g
(1) 50 g	(1) 50 g	(1) 50 g
(2) 20 g	(2) 20 g	(2) 20 g
(1) 10 g	(1) 10 g	(1) 10 g
(1) 5 g	(1) 5 g	(1) 5 g
(2) 2 g	(2) 2 g	(2) 2 g
(1) 1 g	(1) 1 g	(1) 1 g
(1) 500 mg	(1) 500 mg	
(2) 200 mg	(2) 200 mg	
(1) 100 mg	(1) 100 mg	
(1) 50 mg	(1) 50 mg	
(2) 20 mg	(2) 20 mg	
(1) 10 mg	(1) 10 mg	
(1) 5 mg		
(2) 2 mg		
(1) 1 mg		
24 pcs. 1.11111 kg set wt.	20 pcs. 1.1111 kg set wt.	12 pcs. 1.110 kg set wt.



PN 12512 500 g to 1g

Replacement Cases

Main Cases		
Class 5		
Set Range	Part #	Price
500 g - 1mg	11520	\$73.00
500 g - 10 mg	11520	\$73.00
500 g - 1g	11520	\$73.00

Secondary Leatherette Case		
Class 5		
Set Range	Part #	Price
100 g - 1mg	11512	\$37.50
100 g - 10 mg	11512	\$37.50
100 g - 1g	11512	\$37.50

Inserts for Secondary Case		
Class 5 (leaf weight cover not included)		
Set Range	Part #	Price
100 g - 1mg	11519	\$37.50
100 g - 10 mg	11519	\$37.50
100 g - 1g	11518	\$37.50

Accessories

Description	Part #	Price
Statement of Accuracy	36092	\$47.50
Leaf weight cover	11758	\$43.00
Tweezer	65640	\$21.00
Serial number	25836	\$17.00
Premium tweezer	152414	\$43.00

ASTM
PRECISION

OIML
PRECISION

BALANCE
CALIBRATION

STAINLESS
FIELD WEIGHTS

CAST IRON
FIELD WEIGHTS

ASTM
SPECIALTY

ACCESSORIES

ASTM
PRECISIONOIML
PRECISIONBALANCE
CALIBRATIONSTAINLESS
FIELD WEIGHTSCAST IRON
FIELD WEIGHTSASTM
SPECIALTY

ACCESSORIES

STAINLESS STEEL / METRIC SETS

RANGE: 1kg

ASTM

Class 5

Set Range	Part #	Price	Optional Certificate Accredited
1kg - 1mg	12522	\$545.00	\$630.00
1kg - 10mg	12520	\$535.00	\$540.00
1kg - 1g	12518	\$500.00	\$350.00

Weight Set Contents

1kg - 1mg	1kg - 10mg	1kg - 1g
12522	12520	12518
(1) 1kg	(1) 1kg	(1) 1kg
(1) 500g	(1) 500g	(1) 500g
(2) 200g	(2) 200g	(2) 200g
(1) 100g	(1) 100g	(1) 100g
(1) 50g	(1) 50g	(1) 50g
(2) 20g	(2) 20g	(2) 20g
(1) 10g	(1) 10g	(1) 10g
(1) 5g	(1) 5g	(1) 5g
(2) 2g	(2) 2g	(2) 2g
(1) 1g	(1) 1g	(1) 1g
(1) 500mg	(1) 500mg	
(2) 200mg	(2) 200mg	
(1) 100mg	(1) 100mg	
(1) 50mg	(1) 50mg	
(2) 20mg	(2) 20mg	
(1) 10mg	(1) 10mg	
(1) 5mg		
(2) 2mg		
(1) 1mg		
25 pcs. 2.1111kg set wt.	21 pcs. 2.1111kg set wt.	13 pcs. 2.11kg set wt.



PN 12518 1kg to 1g

Replacement Cases

Main Cases			
Class 5			
Set Range	Part #	Price	
1kg - 1mg	11521	\$73.00	
1kg - 10mg	11521	\$73.00	
1kg - 1g	11521	\$73.00	

Secondary Leatherette Case			
Class 5			
Set Range	Part #	Price	
100g - 1mg	11512	\$37.50	
100g - 10mg	11512	\$37.50	
100g - 1g	11512	\$37.50	

Inserts			
Class 5 (leaf weight cover not included)			
Set Range	Part #	Price	
100g - 1mg	11519	\$37.50	
100g - 10mg	11519	\$37.50	
100g - 1g	11518	\$37.50	

Accessories

Description	Part #	Price
Statement of Accuracy	36092	\$47.50
Leaf weight cover	11758	\$43.00
Tweezer	65640	\$21.00
Serial number	25836	\$17.00
Premium tweezer	152414	\$43.00

RANGE: 2 kg

ASTM

Class 5			Optional Certificate
Set Range	Part #	Price	Accredited
2 kg - 1 mg	12528	\$660.00	\$640.00
(5) 2 kg - 1 mg	12534	\$1,040.00	\$818.00
2 kg - 10 mg	12526	\$625.00	\$590.00
(5) 2 kg - 10 mg	12532	\$1,040.00	\$730.00
2 kg - 1 g	12524	\$580.00	\$395.00
(5) 2 kg - 1 g	12530	\$965.00	\$565.00

Weight Set Contents

2 kg - 1 mg	(5) 2 kg - 1 mg	2 kg - 10 mg	(5) 2 kg - 10 mg	2 kg - 1 g	(5) 2 kg - 1 g
12528	12534	12526	12532	12524	12530
(1) 2 kg	(5) 2 kg	(1) 2 kg	(5) 2 kg	(1) 2 kg	(5) 2 kg
(1) 1 kg	-	(1) 1 kg	-	(1) 1 kg	-
(1) 500 g	(5) 500 g	(1) 500 g	(5) 500 g	(1) 500 g	(5) 500 g
(2) 200 g	(2) 200 g	(2) 200 g	(2) 200 g	(2) 200 g	(2) 200 g
(1) 100 g	(1) 100 g	(1) 100 g	(1) 100 g	(1) 100 g	(1) 100 g
(1) 50 g	(1) 50 g	(1) 50 g	(1) 50 g	(1) 50 g	(1) 50 g
(2) 20 g	(2) 20 g	(2) 20 g	(2) 20 g	(2) 20 g	(2) 20 g
(1) 10 g	(1) 10 g	(1) 10 g	(1) 10 g	(1) 10 g	(1) 10 g
(1) 5 g	(1) 5 g	(1) 5 g	(1) 5 g	(1) 5 g	(1) 5 g
(2) 2 g	(2) 2 g	(2) 2 g	(2) 2 g	(2) 2 g	(2) 2 g
(1) 1 g	(1) 1 g	(1) 1 g	(1) 1 g	(1) 1 g	(1) 1 g
(1) 500 mg	(1) 500 mg	(1) 500 mg	(1) 500 mg		
(2) 200 mg	(2) 200 mg	(2) 200 mg	(2) 200 mg		
(1) 100 mg	(1) 100 mg	(1) 100 mg	(1) 100 mg		
(1) 50 mg	(1) 50 mg	(1) 50 mg	(1) 50 mg		
(2) 20 mg	(2) 20 mg	(2) 20 mg	(2) 20 mg		
(1) 10 mg	(1) 10 mg	(1) 10 mg	(1) 10 mg		
(1) 5 mg	(1) 5 mg				
(2) 2 mg	(2) 2 mg				
(1) 1 mg	(1) 1 mg				
26 pc 4.11111 kg set wt.	33 pc 13.11111 kg set wt.	22 pc 4.1111 kg set wt.	29 pc 13.1111 kg set wt.	14 pc 4.110 kg set wt.	21 pc 13.11 kg set wt.



PN 12528 2 kg to 1 mg

Replacement Cases

Main Cases		
Class 5		
Set Range	Part #	Price
2 kg - 1 mg	11522	\$180.00
(5) 2 kg - 1 mg	11523	\$250.00
2 kg - 10 mg	11522	\$180.00
(5) 2 kg - 10 mg	11523	\$250.00
2 kg - 1 g	11522	\$180.00
(5) 2 kg - 1 g	11523	\$250.00

Secondary Leatherette Case		
Class 5		
Set Range	Part #	Price
100 g - 1 mg	11512	\$37.50
100 g - 10 mg	11512	\$37.50
100 g - 1 g	11512	\$37.50

Inserts		
Class 5 (leaf weight cover not included)		
Set Range	Part #	Price
100 g - 1 mg	11519	\$37.50
100 g - 10 mg	11519	\$37.50
100 g - 1 g	11518	\$37.50

Accessories

Description	Part #	Price
Statement of Accuracy	36092	\$47.50
Leaf weight cover	11758	\$43.00
Tweezer	65640	\$21.00
Serial number	25836	\$17.00
Premium tweezer	152414	\$43.00

ASTM
PRECISIONOIML
PRECISIONBALANCE
CALIBRATIONSTAINLESS
FIELD WEIGHTSCAST IRON
FIELD WEIGHTSASTM
SPECIALTY

ACCESSORIES

STAINLESS STEEL / METRIC SETS

RANGE: 5 kg

ASTM

Class 5

Set Range	Part #	Price	Optional Certificate Accredited
5 kg - 1 mg	12537	\$890.00	\$780.00
(2) 5 kg - 1 mg	12542	\$1,320.00	\$800.00
5 kg - 10 mg	12536	\$825.00	\$680.00
(2) 5 kg - 10 mg	12539	\$1,160.00	\$710.00
5 kg - 1 g	12535	\$785.00	\$490.00
(2) 5 kg - 1 g	12538	\$1,130.00	\$520.00
(3) 5 kg	12562	\$995.00	\$220.00

Weight Set Contents

5 kg - 1 mg	(2) 5 kg - 1 mg	5 kg - 10 mg	(2) 5 kg - 10 mg	5 kg - 1 g	(2) 5 kg - 1 g	(3) 5 kg
12537	12542	12536	12539	12535	12538	12562
(1) 5 kg (2) 2 kg (1) 1 kg (1) 500 g (2) 200 g (1) 100 g (1) 50 g (2) 20 g (1) 10 g (1) 5 g (2) 2 g (1) 1 g (1) 500 mg (2) 200 mg (1) 100 mg (1) 50 mg (2) 20 mg (1) 10 mg (1) 5 mg (2) 2 mg (1) 1 mg	(2) 5 kg (2) 2 kg (1) 1 kg (5) 500 g (2) 200 g (1) 100 g (1) 50 g (2) 20 g (1) 10 g (1) 5 g (2) 2 g (1) 1 g (1) 500 mg (2) 200 mg (1) 100 mg (1) 50 mg (2) 20 mg (1) 10 mg (1) 5 mg (2) 2 mg (1) 1 mg	(1) 5 kg (2) 2 kg (1) 1 kg (1) 500 g (2) 200 g (1) 100 g (1) 50 g (2) 20 g (1) 10 g (1) 5 g (2) 2 g (1) 1 g (1) 500 mg (2) 200 mg (1) 100 mg (1) 50 mg (2) 20 mg (1) 10 mg	(2) 5 kg (2) 2 kg (1) 1 kg (5) 500 g (2) 200 g (1) 100 g (1) 50 g (2) 20 g (1) 10 g (1) 5 g (2) 2 g (1) 1 g (1) 500 mg (2) 200 mg (1) 100 mg (1) 50 mg (2) 20 mg (1) 10 mg	(1) 5 kg (2) 2 kg (1) 1 kg (1) 500 g (2) 200 g (1) 100 g (1) 50 g (2) 20 g (1) 10 g (1) 5 g (2) 2 g (1) 1 g	(2) 5 kg (2) 2 kg (1) 1 kg (5) 500 g (2) 200 g (1) 100 g (1) 50 g (2) 20 g (1) 10 g (1) 5 g (2) 2 g (1) 1 g	(3) 5 kg
28 pcs. 11.11 kg set wt.	33 pcs. 18.11 kg set wt.	24 pcs. 11.1111 kg set wt.	29 pcs. 18.1111 kg set wt.	16 pcs. 11.11 kg set wt.	21 pcs. 18.110 kg set wt.	3 pcs. 15 kg set wt.



PN 12542 (2) 5 kg to 1 mg

Replacement Cases

Main Cases		
Class 5		
Set Range	Part #	Price
5 kg - 1 mg	11524	\$250.00
(2) 5 kg - 1 mg	11525	\$250.00
5 kg - 10 mg	11524	\$250.00
(2) 5 kg - 10 mg	11525	\$250.00
5 kg - 1 g	11524	\$250.00
(2) 5 kg - 1 g	11525	\$250.00
(3) 5 kg	11558	\$250.00

Secondary Leatherette Case		
Class 5		
Set Range	Part #	Price
100 g - 1 mg	11512	\$37.50
100 g - 10 mg	11512	\$37.50
100 g - 1 g	11512	\$37.50

Inserts		
Class 5 (leaf weight cover not included)		
Set Range	Part #	Price
100 g - 1 mg	11519	\$37.50
100 g - 10 mg	11519	\$37.50
100 g - 1 g	11518	\$37.50

Accessories

Description	Part #	Price
Statement of Accuracy	36092	\$47.50
Leaf weight cover	11758	\$43.00
Tweezer	65640	\$21.00
Serial number	25836	\$17.00
Premium tweezer	152414	\$43.00

100

An ISO 9001 Registered Company ©2022 Rice Lake Weighing Systems 7122
Prices and specifications subject to change without notice. Visit ricelake.com for current prices.

RANGE: 4 oz

ASTM

Class 5

Optional Certificate

Set Range	Part #	Price	Accredited
4 oz - 1/32 oz	12623	\$215.00	\$215.00
4 oz - 0.05 oz	12625	\$235.00	\$195.00
0.2 lb - 0.001lb	12576	\$225.00	\$260.00
0.3 lb - 0.001lb	12654	\$505.00	\$260.00

Weight Set Contents

4 oz - 1/32 oz	4 oz - 0.05 oz	0.2 lb - 0.001lb	0.3 lb - 0.001lb
12623	12625	12576	12654
(1) 4 oz	(1) 4 oz	-	(1) 0.3 lb
(1) 2 oz	(1) 2 oz	(2) 0.2 lb	(1) 0.2 lb
(1) 1 oz	(1) 1 oz	(1) 0.1 lb	(1) 0.1 lb
(1) 1/2 oz	(1) 0.5 oz	(1) 0.05 lb	(1) 0.05 lb
(1) 1/4 oz	(1) 0.2 oz	-	(1) 0.03 lb
(1) 1/8 oz	(1) 0.1 oz	(2) 0.02 lb	(1) 0.02 lb
(1) 1/16 oz	(1) 0.05 oz	(1) 0.01 lb	(1) 0.01 lb
(2) 1/32 oz		(1) 0.005 lb	(1) 0.005 lb
		-	(1) 0.003 lb
		(2) 0.002 lb	(1) 0.002 lb
		(1) 0.001 lb	(1) 0.001 lb
9 pcs. 1/2 lb set wt.	8 pcs. 1 lb 0.05 oz set wt.	11 pcs. 0.61 lb set wt.	11 pcs. 0.722 lb set wt.



PN 12623 4 oz to 1/32 oz

Replacement Cases

Main Cases		
Class 5		
Set Size	Part #	Price
4 oz - 1/32 oz	11510	\$37.50
4 oz - 0.05 oz	11510	\$37.50
0.2 lb - 0.001lb	11512	\$37.50
0.3 lb - 0.001lb	200180	\$40.00

Inserts		
Class 5		
Size	Part #	Price
4 oz - 1/32 oz	11552	\$26.50
4 oz - 0.05 oz	11553	\$26.50
0.2 oz - 0.001lb	200160	\$40.00

Accessories

Description	Part #	Price
Statement of Accuracy	36092	\$47.50
Serial number	25836	\$17.00

ASTM
PRECISION

OIML
PRECISION

BALANCE
CALIBRATION

STAINLESS
FIELD WEIGHTS

CAST IRON
FIELD WEIGHTS

ASTM
SPECIALTY

ACCESSORIES

ASTM
PRECISIONOIML
PRECISIONBALANCE
CALIBRATIONSTAINLESS
FIELD WEIGHTSCAST IRON
FIELD WEIGHTSASTM
SPECIALTY

ACCESSORIES

STAINLESS STEEL / AVOIRDUPOIS SET

RANGE: 1lb

ASTM

Class 5

Set Range	Part #	Price
1lb - 1/32 oz (fractional)	12591	\$345.00
1lb - 0.001lb (decimal)	12593	\$405.00
1lb - 0.05 oz (combination)	12595	\$370.00

Optional Certificate

Accredited
\$280.00
\$330.00
\$255.00

Weight Set Contents

1lb - 1/32 oz	1lb - 0.001lb	1lb - 0.05 oz
12591	12593	12595
(1) 1lb	(1) 1lb	(1) 1lb
(1) 8 oz	(1) 0.5 lb	(1) 8 oz
(1) 4 oz	(2) 0.2 lb	(1) 4 oz
(1) 2 oz	(1) 0.1lb	(1) 2 oz
(1) 1oz	(1) 0.05 lb	(1) 1oz
(1) 1/2 oz	(2) 0.02 lb	(1) 0.5 oz
(1) 1/4 oz	(1) 0.01lb	(2) 0.2 oz
(1) 1/8 oz	(1) 0.005 lb	(1) 0.1 oz
(1) 1/16 oz	(2) 0.002 lb	(1) 0.05 oz
(2) 1/32 oz	(1) 0.001lb	
11 pcs. 2 lb set wt.	13 pcs. 2.1110 lb set wt.	10 pcs. 1.990625 lb set wt.



PN 12591 1 lb to 1/32 oz

Replacement Cases

Main Cases		
Class 5		
Set Range	Part #	Price
1lb - 1/32 oz (fractional)	11544	\$79.00
1lb - 0.001lb (decimal)	11544	\$79.00
1lb - 0.05 oz (combination)	11544	\$79.00

Secondary Leatherette Cases		
Class 5		
Set Range	Part #	Price
1lb - 1/32 oz	11510	\$37.50
1lb - 0.001lb	11512	\$37.50
1lb - 0.05 oz	11510	\$37.50

Inserts		
Class 5		
Set Range	Part #	Price
1lb - 1/32 oz	11552	\$26.50
1lb - 0.001lb	11553	\$26.50
1lb - 0.05 oz	200160	\$40.00

Accessories

Description	Part #	Price
Statement of Accuracy	36092	\$47.50
Serial number	25836	\$17.00

RANGE: 2 lb

ASTM

Class 5

Set Size	Part #	Price
2 lb - 1/32 oz (fractional)	12597	\$455.00
(2) 2 lb - 1/32 oz (fractional)	12603	\$590.00
2 lb - 0.001 lb (decimal)	12599	\$470.00
(2) 2 lb - 0.001 lb (decimal)	12605	\$590.00
2 lb - 0.05 oz (decimal)	12601	\$500.00
(2) 2 lb - 0.05 oz (decimal)	12607	\$590.00

Optional Certificate

Accredited
\$325.00
\$365.00
\$365.00
\$415.00
\$270.00
\$310.00

Weight Set Contents

2 lb - 1/32 oz	(2) 2 lb - 1/32 oz	2 lb - 0.001 lb	(2) 2 lb - 0.001 lb	2 lb - 0.05 oz	(2) 2 lb - 0.05 oz
12597	12603	12599	12605	12601	12607
(1) 2 lb	(2) 2 lb	(1) 2 lb	(2) 2 lb	(1) 2 lb	(2) 2 lb
(1) 1 lb	(1) 1 lb	(1) 1 lb	(1) 1 lb	(1) 1 lb	(1) 1 lb
(1) 8 oz	(1) 8 oz	(1) 0.5 lb	(1) 0.5 lb	(1) 8 oz	(1) 8 oz
(1) 4 oz	(1) 4 oz	(2) 0.2 lb	(2) 0.2 lb	(1) 4 oz	(1) 4 oz
(1) 2 oz	(1) 2 oz	(1) 0.1 lb	(1) 0.1 lb	(1) 2 oz	(1) 2 oz
(1) 1 oz	(1) 1 oz	(1) 0.05 lb	(1) 0.05 lb	(1) 1 oz	(1) 1 oz
(1) 1/2 oz	(1) 1/2 oz	(2) 0.02 lb	(2) 0.02 lb	(1) 0.5 oz	(1) 0.5 oz
(1) 1/4 oz	(1) 1/4 oz	(1) 0.01 lb	(1) 0.01 lb	(2) 0.2 oz	(2) 0.2 oz
(1) 1/8 oz	(1) 1/8 oz	(1) 0.005 lb	(1) 0.005 lb	(1) 0.1 oz	(1) 0.1 oz
(1) 1/16 oz	(1) 1/16 oz	(2) 0.002 lb	(2) 0.002 lb	(1) 0.05 oz	(1) 0.05 oz
(2) 1/32 oz	(2) 1/32 oz	(1) 0.001 lb	(1) 0.001 lb		
12 pcs. 4 lb set wt.	13 pcs. 6 lb set wt.	14 pcs. 4.108 lb set wt.	15 pcs. 6.1100 lb set wt.	11 pcs. 4.7875 lb set wt.	12 pcs. 6 lb 0.05 oz set wt.



PN 12599 2 lb - 0.001 lb

Replacement Cases

Main Cases		
Class 5		
Set Size	Part #	Price
2 lb - 1/32 oz (fractional)	11547	\$79.00
(2) 2 lb - 1/32 oz (fractional)	11548	\$79.00
2 lb - 0.001 lb (decimal)	11547	\$79.00
(2) 2 lb - 0.001 lb (decimal)	11548	\$79.00
2 lb - 0.05 oz (decimal)	11547	\$79.00
(2) 2 lb - 0.05 oz (decimal)	11548	\$79.00

Secondary Leatherette Cases		
Class 5		
Size	Part #	Price
4 oz - 1/32 oz	11510	\$37.50
0.2 lb - 0.001 lb	11512	\$37.50
4 oz - 0.05 oz	11510	\$37.50

Inserts		
Class 5		
Size	Part #	Price
2 lb - 1/32 oz	11552	\$26.50
2 lb - 0.001 lb	11553	\$26.50
2 lb - 0.05 oz	200160	\$40.00

Accessories

Description	Part #	Price
Statement of Accuracy	36092	\$47.50
Serial number	25836	\$17.00

ASTM
PRECISION

OIML
PRECISION

BALANCE
CALIBRATION

STAINLESS
FIELD WEIGHTS

CAST IRON
FIELD WEIGHTS

ASTM
SPECIALTY

ACCESSORIES

RANGE: 5 lb

ASTM
PRECISION

OIML
PRECISION

BALANCE
CALIBRATION

STAINLESS
FIELD WEIGHTS

CAST IRON
FIELD WEIGHTS

ASTM
SPECIALTY

ACCESSORIES

ASTM

Class 5

Optional Certificate

Set Range	Part #	Price	Accredited
5 lb - 1/32 oz	12615	\$580.00	\$410.00
(5) 5 lb - 1/32 oz	12579	\$1,190.00	\$700.00
5 lb - 0.001 lb	12617	\$585.00	\$460.00
(5) 5 lb - 0.001 lb (combination)	12582	\$1,220.00	\$755.00
(5) 5 lb - 0.001 lb	12634	\$1,220.00	\$755.00
5 lb - 0.05 oz (combination)	12619	\$600.00	\$385.00
(5) 5 lb - 0.05 oz (combination)	12636	\$1,150.00	\$650.00
(3) 5 lb - 1 gr (21 lb fractional U.S. Postal Service)	12627	\$1,210.00	\$790.00
(5) 5 lb - 1 gr (31 lb 55 gr)	12661	\$1,390.00	\$920.00
5 lb x (6) (30 lb)	12640	\$1,070.00	\$470.00

Weight Set Contents

5 lb - 1/32 oz	(5) 5 lb - 1/32 oz	5 lb - 0.001 lb	(5) 5 lb - 0.001 lb	(5) 5 lb - 0.001 lb	5 lb - 0.05 oz	(5) 5 lb - 0.05 oz
12615	12579	12617	12582	12634	12619	12636
(1) 5 lb	(5) 5 lb	(1) 5 lb	(5) 5 lb	(5) 5 lb	(1) 5 lb	(5) 5 lb
(2) 2 lb	-	(2) 2 lb	-	-	(2) 2 lb	-
(1) 1 lb	(5) 1 lb	(1) 1 lb	(5) 1 lb	(5) 1 lb	(1) 1 lb	(5) 1 lb
(1) 8 oz	(1) 8 oz	(1) 0.5 lb	(1) 8 oz	(1) 0.5 lb	(1) 8 oz	(1) 8 oz
(1) 4 oz	(1) 4 oz	(2) 0.2 lb	(1) 4 oz	(2) 0.2 lb	(1) 4 oz	(1) 4 oz
(1) 2 oz	(1) 2 oz	(1) 0.1 lb	(2) 0.2 lb	(1) 0.1 lb	(1) 2 oz	(1) 2 oz
(1) 1 oz	(1) 1 oz	(1) 0.05 lb	(1) 2 oz	(1) 0.05 lb	(1) 1 oz	(1) 1 oz
(1) 1/2 oz	(1) 1/2 oz	(2) 0.02 lb	(1) 0.1 lb	(2) 0.02 lb	(1) 0.5 oz	(1) 0.5 oz
(1) 1/4 oz	(1) 1/4 oz	(1) 0.01 lb	(1) 1 oz	(1) 0.01 lb	(2) 0.2 oz	(2) 0.2 oz
(1) 1/8 oz	(1) 1/8 oz	(1) 0.005 lb	(1) 0.05 lb	(1) 0.005 lb	(1) 0.1 oz	(1) 0.05 oz
(1) 1/16 oz	(1) 1/16 oz	(2) 0.002 lb	(1) 1/2 oz	(2) 0.002 lb	(1) 0.05 oz	
(2) 1/32 oz	(2) 1/32 oz	(1) 0.001 lb	(2) 0.02 lb	(1) 0.001 lb		
			(1) 1/4 oz			
			(1) 0.01 lb			
			(1) 1/8 oz			
			(1) 0.005 lb			
			(1) 1/16 oz			
			(2) 0.002 lb			
			(2) 1/32 oz			
			(1) 0.001 lb			
14 pcs. 11 lb set wt.	20 pcs. 31 lb set wt.	16 pcs. 11.11 lb set wt.	31 pcs. 31.61 lb set wt.	22 pcs. 31.11 lb set wt.	13 pcs. 11 lb 0.05 oz set wt.	18 pcs. 31 lb 0.05 oz set wt.

Replacement Cases

Main Cases		
Class 5		
Set Range	Part #	Price
5 lb - 1/32 oz	11550	\$245.00
(5) 5 lb - 1/32 oz	11542	\$245.00
5 lb - 0.001 lb	11550	\$245.00
(5) 5 lb - 0.001 lb (combination)	11542	\$245.00
(5) 5 lb - 0.001 lb	11542	\$245.00
5 lb - 0.05 oz (combination)	11550	\$245.00
5 lb - 0.05 oz (combination)	11542	\$245.00
(3) 5 lb - 1 gr (21 lb fractional U.S. Postal Service)	11554	\$245.00

Main Cases		
Class 5		
Set Range	Part #	Price
(5) 5 lb - 1 gr (31 lb 55 gr)	11570	\$245.00
5 lb x (6) (30 lb)	11559	\$245.00

Secondary Leatherette Cases		
Class 5		
Set Range	Part #	Price
5 lb - 1/32 oz	11510	\$37.50
(5) 5 lb - 1/32 oz	11510	\$37.50
5 lb - 0.001 lb	11512	\$37.50

Secondary Leatherette Cases		
Class 5		
Set Range	Part #	Price
(5) 5 lb - 0.001 lb (combination)	11510 and 11512	\$37.50
(5) 5 lb - 0.001 lb	11512	\$37.50
5 lb - 0.05 oz	11510	\$37.50
(5) 5 lb - 0.05 oz	11510	\$37.50
(3) 5 lb - 1 gr	11510	\$37.50

(3) 5 lb - 1 gr	(5) 5 lb - 1 gr	(6) 5 lb
12627	12661	12640
(3) 5 lb	(5) 5 lb	(6) 5 lb
(5) 1 lb	(5) 1 lb	
(1) 8 oz	(1) 8 oz	
(1) 4 oz	(1) 4 oz	
(1) 2 oz	(1) 2 oz	
(1) 1 oz	(1) 1 oz	
(1) 1/2 oz	(1) 1/2 oz	
(1) 1/4 oz	(1) 1/4 oz	
(1) 1/8 oz	(1) 1/8 oz	
(1) 1/16 oz	(1) 1/16 oz	
(2) 1/32 oz	(2) 1/32 oz	
(2) 10 gr	(1) 20 gr	
(2) 5 gr	(2) 10 gr	
(2) 2 gr	(2) 5 gr	
(1) 1 gr	(2) 2 gr	
	(1) 1 gr	
25 pcs. 21lb 55gr set wt.	28 pcs. 31lb 55gr set wt.	6 pcs. 30 lb set wt.



PN 12582 5 lb to 0.001 lb

Accessories

Inserts		
Class 5		
Size	Part #	Price
5 lb - 1/32 oz	11552	\$26.50
(5) 5 lb - 1/32 oz	11552	\$26.50
5 lb - 0.001lb	200160	\$40.00
(5) 5 lb - 0.001lb (combination)	200160	\$40.00
(5) 5 lb - 0.001lb	200160	\$40.00
5 lb - 0.05 oz	11553	\$26.50
(5) 5 lb - 0.05 oz	11553	\$26.50
(3) 5 lb - 1 gr	11552	\$26.50

Description	Part #	Price
Statement of Accuracy	36092	\$47.50
Serial number	25836	\$17.00

STAINLESS STEEL / AVOIRDUPOIS SET

RANGE: 10 lb

ASTM
PRECISION

OIML
PRECISION

BALANCE
CALIBRATION

STAINLESS
FIELD WEIGHTS

CAST IRON
FIELD WEIGHTS

ASTM
SPECIALTY

ACCESSORIES

ASTM

Set Range	Part #	Price	Optional Certificate	
				Accredited
(3) 10 lb	12638	\$925.00		\$235.00
10 lb - 1/32 oz	12609	\$845.00		\$465.00
10 lb - 0.001lb	12611	\$830.00		\$510.00
10 lb - 0.05 oz (21lb x 0.05 oz)	12613	\$900.00		\$415.00
10 lb - 1/4 oz	12573	\$1,310.00		\$475.00
10 lb - 1/32 oz	12642	\$1,210.00		\$465.00
10 lb - 0.001lb	12588	\$1,450.00		\$780.00
10 lb - 0.001lb	12644	\$1,150.00		\$510.00
10 lb - 0.001lb (combination)	12648	\$1,370.00		\$555.00
10 lb - 0.05 oz (combination)	12646	\$1,300.00		\$415.00
10 lb - 1/32 oz	12628	\$1,570.00		\$755.00
10 lb - 0.001lb	12621	\$1,720.00		\$800.00
10 lb - 0.05 oz (combination)	12632	\$1,750.00		\$725.00
10 lb - 0.001lb (51.61lb combination)	12650	\$1,770.00		\$800.00

Weight Set Contents

(3) 10 lb	10 lb - 1/32 oz	10 lb - 0.001lb	10 lb - 0.05 oz	10 lb - 1/4 oz	10 lb - 1/32 oz	10 lb - 0.001lb	10 lb - 0.001lb	10 lb - 0.001lb
12638	12609	12611	12613	12573	12642	12588	12644	12648
(3) 10 lb	(1) 10 lb (1) 5 lb (2) 2 lb (1) 1 lb (1) 8 oz (1) 4 oz (1) 2 oz (1) 1 oz (1) 1/2 oz (1) 1/4 oz (1) 1/8 oz (1) 1/16 oz (2) 1/32 oz	(1) 10 lb (1) 5 lb (2) 2 lb (1) 1 lb (1) 0.5 lb (2) 0.2 lb (1) 0.1 lb (1) 0.05 lb (2) 0.02 lb (1) 0.01 lb (1) 0.005 lb (2) 0.002 lb (1) 0.001 lb	(1) 10 lb (1) 5 lb (2) 2 lb (1) 1 lb (1) 8 oz (1) 4 oz (1) 2 oz (1) 1 oz (1) 0.5 oz (1) 0.2 oz (1) 0.1 oz (1) 0.05 oz	(2) 10 lb (1) 5 lb (5) 1 lb (3) 4 oz (3) 1 oz (2) 1/2 oz (2) 1/4 oz	(2) 10 lb (1) 5 lb (2) 2 lb (1) 1 lb (1) 8 oz (1) 4 oz (1) 2 oz (1) 1 oz (1) 1/2 oz (1) 1/4 oz (1) 1/8 oz (1) 1/16 oz (2) 1/32 oz	(2) 10 lb (1) 5 lb (5) 1 lb (3) 4 oz (2) 0.2 lb (1) 0.1 lb (3) 1 oz (1) 0.05 lb (2) 1/2 oz (2) 0.02 lb (2) 1/4 oz (1) 0.01 lb (1) 0.005 lb (2) 0.002 lb (1) 0.001 lb	(2) 10 lb (1) 5 lb (2) 2 lb (1) 1 lb (1) 0.5 lb (2) 0.2 lb (1) 0.1 lb (1) 0.05 lb (2) 0.02 lb (1) 0.01 lb (1) 0.005 lb (2) 0.002 lb (1) 0.001 lb	(2) 10 lb (1) 5 lb (2) 2 lb (1) 1 lb (1) 8 oz (1) 4 oz (1) 2 oz (1) 1 oz (1) 1/2 oz (1) 1/4 oz (1) 1/8 oz (1) 1/16 oz (2) 1/32 oz (2) 0.2 lb (1) 0.1 lb (1) 0.05 lb (2) 0.02 lb (1) 0.01 lb (1) 0.005 lb (2) 0.002 lb (1) 0.001 lb
3 pcs. 30lb set wt.	15 pcs. 21lb set wt.	17 pcs. 21.11lb set wt.	13 pcs. 21lb 0.05oz set wt.	18 pcs. 31lb 1/2 oz set wt.	16 pcs. 31lb set wt.	29 pcs. 31lb 1/2 oz set wt.	18 pcs. 31.1100 lb set wt.	27 pcs. 31lb set wt.

Replacement Cases

Main Cases		
Class 5		
Set Range	Part #	Price
(3) 10 lb	11558	\$250.00
10 lb - 1/32 oz	11549	\$245.00
10 lb - 0.001lb	11549	\$245.00
10 lb - 0.05 oz (21lb x 0.05 oz)	11549	\$245.00
10 lb - 1/4 oz	11540	\$245.00
10 lb - 1/32 oz	11562	\$245.00
10 lb - 0.001lb	11543	\$245.00
10 lb - 0.001lb	11562	\$245.00

Main Cases		
Class 5		
Set Range	Part #	Price
10 lb - 0.001lb (combination)	11562	\$245.00
10 lb - 0.05 oz (combination)	11562	\$245.00
10 lb - 1/32 oz	11555	\$245.00
10 lb - 0.001lb	11555	\$245.00
10 lb - 0.05 oz (combination)	11555	\$245.00
10 lb - 0.001lb (combination)	11563	\$245.00

Secondary Leatherette Cases		
Class 5		
Size	Part #	Price
10 lb - 0.001lb	11512	\$37.50
10 lb - 1/32 oz	11510	\$37.50

Inserts		
Class 5		
Size	Part #	Price
10 lb - 0.001lb	200160	\$40.00
10 lb - 1/32 oz	11552	\$26.50
10 lb - 0.05 oz	11553	\$26.50

STAINLESS STEEL / AVOIRDUPOIS SET

RANGE: 10 lb



ASTM
PRECISION

OIML
PRECISION

BALANCE
CALIBRATION

STAINLESS
FIELD WEIGHTS

CAST IRON
FIELD WEIGHTS

ASTM
SPECIALTY

ACCESSORIES

10 lb - 0.05 oz	10 lb - 1/32 oz	10 lb - 0.001 lb	10 lb - 0.05 oz	10 lb - 0.001 lb
12646	12628	12621	12632	12650
(2) 10 lb	(3) 10 lb	(3) 10 lb	(3) 10 lb	(3) 10 lb
(1) 5 lb	(3) 5 lb	(3) 5 lb	(3) 5 lb	(3) 5 lb
(2) 2 lb	—	—	—	—
(1) 1 lb	(5) 1 lb	(5) 1 lb	(5) 1 lb	(5) 1 lb
(1) 8 oz	(1) 8 oz	(1) 0.5 lb	(1) 8 oz	(1) 8 oz
(1) 4 oz	(1) 4 oz	(2) 0.2 lb	(1) 4 oz	(1) 4 oz
(1) 2 oz	(1) 2 oz	(1) 0.1 lb	(1) 2 oz	(2) 0.2 lb
(1) 1 oz	(1) 1 oz	(1) 0.05 lb	(1) 1 oz	(1) 2 oz
(1) 0.5 oz	(1) 1/2 oz	(2) 0.02 lb	(1) 0.5 oz	(1) 0.1 lb
(2) 0.2 oz	(1) 1/4 oz	(1) 0.01 lb	(2) 0.20 oz	(1) 1 oz
(1) 0.1 oz	(1) 1/8 oz	(1) 0.005 lb	(1) 0.1 oz	(1) 0.05 lb
(1) 0.05 oz	(1) 1/16 oz	(2) 0.002 lb	(1) 0.05 oz	(1) 1/2 oz
	(2) 1/32 oz	(1) 0.001 lb		(2) 0.02 lb
				(1) 1/4 oz
				(1) 0.01 lb
				(1) 1/8 oz
				(1) 0.005 lb
				(1) 1/16 oz
				(2) 0.002 lb
				(2) 1/32 oz
				(1) 0.001 lb
15 pcs. 31lb 0.05oz set wt.	21 pcs. 51lb set wt.	23 pcs. 51.11lb set wt.	20 pcs. 51lb 0.05oz set wt.	32 pcs. 51.6100 lb set wt.

Accessories

Description	Part #	Price
Statement of Accuracy	36092	\$47.50
Leaf weight cover	11758	\$43.00
Tweezer	65640	\$21.00
Serial number	25836	\$17.00
Premium tweezer	152414	\$43.00

ASTM

Cast Iron Field Weights

Applications:

Field standards for testing industrial devices Class III, Class III L or Class III I

Testing for non-marked scales without class designation

Verifying scales are within specified accuracy and tolerances

Styles Available:

Grip-handle design for easy handling
Nesting slab weights for heavy-capacity weighing

Slotted weights and hangers for suspended weighing

Counterpoise weights for ratio weighing

Features:

Nominal value marked on weight

Weight capacities of 10 kg/20 lb and up meet NIST Handbook 105-1 and Handbook 44 specifications

Metric weights designated by gold paint

Avoirdupois (pound) weights designated by silver paint

Serial numbers may be stamped on weights (optional)



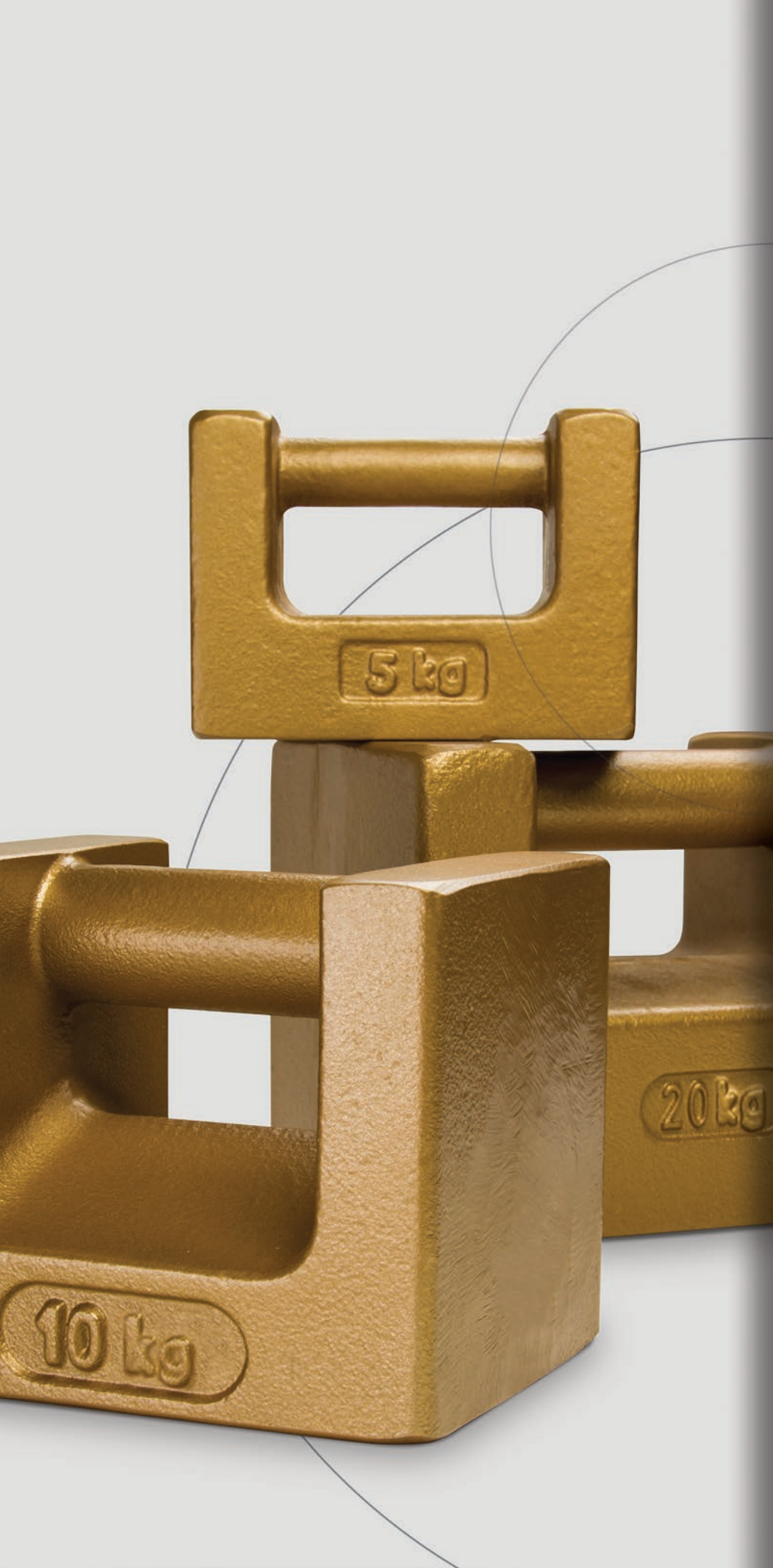

Grip-handle and Nesting Slab

110 Range: 3,000 lb – 1 lb

Grip-handle

111 Range: 1,000 kg – 500 g

Slotted Interlocking and Hanger

112 Range: 100 lb – 200 g

Counterpoise and Hanger Weights

113 Range: 200 kg – 7 oz

Avoirdupois Counterpoise and Hanger

114 Range: 500 lb – 7 oz

CAST IRON / GRIP-HANDLE AND NESTING SLAB

RANGE: 3,000 lb – 1 lb

ASTM

Class 6

Grip-handle

Weight	Part #	Length	Width	Height	Slot Width	Slot Depth*	Price	Optional Certificate	
								Accredited	
3,000 lb	12872	20-3/4 in (527 mm)	20-3/4 in (527 mm)	29 in (737 mm)	3-1/2 in (89 mm)	2-3/4 in (70 mm)	\$9,900.00		\$310.00
2,500 lb	12854	20-3/4 in (527 mm)	20-3/4 in (527 mm)	24-3/4 in (629 mm)	3-31/32 in (101 mm)	2-3/4 in (70 mm)	\$8,900.00		\$235.00
2,000 lb	12868	20-3/4 in (527 mm)	20-3/4 in (527 mm)	19-1/2 in (495 mm)	3-1/2 in (89 mm)	2-3/4 in (70 mm)	\$7,850.00		\$235.00
1,500 lb	12864	15-1/8 in (384 mm)	15-1/8 in (384 mm)	26-7/8 in (683 mm)	2-1/2 in (64 mm)	2-1/4 in (57 mm)	\$7,125.00		\$235.00
1,250 lb	12858	15 in (381 mm)	15 in (381 mm)	23-3/4 in (603 mm)	2-1/2 in (64 mm)	2-1/4 in (57 mm)	\$5,950.00		\$235.00
1,000 lb	12850	15-1/2 in (394 mm)	15 in (381 mm)	18-11/16 in (478 mm)	2-3/4 in (70 mm)	2-29/32 in (74 mm)	\$2,850.00		\$235.00
500 lb	12844	12 in (305 mm)	11-1/2 in (292 mm)	15-3/4 in (400 mm)	2-1/2 in (64 mm)	1-29/32 in (48 mm)	\$1,790.00		\$235.00
250 lb	12892	9-3/4 in (248 mm)	9-3/4 in (248 mm)	12 in (305 mm)	2-1/2 in (64 mm)	2 in (51 mm)	\$1,640.00		\$235.00
200 lb	12890	9-3/4 in (248 mm)	9-3/4 in (248 mm)	10 in (254 mm)	2-1/2 in (64 mm)	2 in (51 mm)	\$1,430.00		\$235.00
100 lb	12862	7 in (178 mm)	9-1/8 in (232 mm)	7-7/8 in (200 mm)	4-1/2 in (114 mm)	1-1/2 in (38 mm)	\$625.00		\$105.00
50 lb	12839	5-1/2 in (140 mm)	7-29/32 in (201 mm)	6-9/16 in (167 mm)	4-1/2 in (114 mm)	1-21/32 in (42 mm)	\$150.00		\$80.00
30 lb	12878	4-29/32 in (125 mm)	8-1/4 in (210 mm)	4-1/2 in (114 mm)	4-15/32 in (114 mm)	31/32 in (25 mm)	\$200.00		\$80.00
25 lb	12833	4-1/2 in (114 mm)	6-1/2 in (165 mm)	4-15/16 in (125 mm)	3-5/8 in (92 mm)	31/32 in (25 mm)	\$135.00		\$80.00
20 lb	12870	4-15/32 in (114 mm)	5-3/4 in (146 mm)	5-3/32 in (129 mm)	3-31/32 in (101 mm)	1-5/32 in (29 mm)	\$105.00		\$80.00

Class 7

Optional Certificate

Weight	Part #	Length	Width	Height	Price	Optional Certificate	
						Accredited	
10 lb	12828	3-1/4 in (83 mm)	5 in (127 mm)	4-1/32 in (102 mm)	\$82.00		\$80.00
5 lb	12823	2-9/16 in (65 mm)	4 in (102 mm)	3-7/32 in (82 mm)	\$63.00		\$80.00
2 lb	12874	2-1/8 in (54 mm)	3 in (76 mm)	1-3/4 in (45 mm)	\$60.00		\$65.00
1 lb	12876	1-11/16 in (43 mm)	2-1/2 in (64 mm)	1-13/32 in (38 mm)	\$55.00		\$65.00

Class 6

Nesting Slab

Weight	Part #	Length	Width	Height	Slot Width	Slot Depth*	Price	Optional Certificate	
								Accredited	
2,500 lb	12860	30 in (762 mm)	42 in (1067 mm)	8-1/4 in (210 mm)	2 in (51 mm)	2-1/4 in (57 mm)	\$8,900.00		\$235.00
1,000 lb	34563	19-1/2 in (495 mm)	29-1/2 in (749 mm)	7-1/4 in (184 mm)	2 in (51 mm)	2-1/4 in (57 mm)	\$4,500.00		\$235.00

* Slot depth refers to distance between lifting bars and castings.



PN 12860 Nesting Slab



PN 12839 Grip-handle

Accessories

Description	Part #	Price
Statement of Accuracy	36092	\$47.50
Serial number	25836	\$17.00

CAST IRON / GRIP-HANDLE

RANGE: 1,000 kg – 500 g

ASTM

Class 6

Weight	Part #	Length	Width	Height	Slot Width	Slot Depth*	Price	Optional Certificate	
								Accredited	
1,000 kg	12801	20-1/2 in (521mm)	20-1/2 in (521mm)	22 in (559 mm)	3-1/2 in (89 mm)	2-3/4 in (70 mm)	\$7,850.00	\$310.00	
500 kg	12797	15-1/8 in (384mm)	15-1/8 in (384mm)	20-3/4 in (527 mm)	2-1/2 in (64 mm)	2 in (51 mm)	\$2,900.00	\$235.00	
250 kg	12782	12-1/2 in (318mm)	11-1/2 in (292mm)	17-1/2 in (445 mm)	2-1/2 in (64 mm)	1-7/8 in (48 mm)	\$1,820.00	\$235.00	
200 kg	12793	12 in (305mm)	11-1/2 in (292mm)	14-1/4 in (362 mm)	2-1/2 in (64 mm)	1-7/8 in (48 mm)	\$1,570.00	\$235.00	
100 kg	12817	9-7/8 in (251mm)	9-7/8 in (251mm)	11 in (279 mm)	2-1/2 in (64 mm)	2 in (51 mm)	\$1,440.00	\$235.00	
50 kg	12803	7 in (178mm)	9-7/32 in (234 mm)	8-13/16 in (224 mm)	4-15/32 in (114 mm)	1-29/32 in (48 mm)	\$625.00	\$130.00	
35 kg	12805	5-1/2 in (140 mm)	7-7/8 in (200 mm)	9-15/32 in (252 mm)	4-15/32 in (114 mm)	1-1/16 in (27 mm)	\$450.00	\$130.00	
25 kg	12775	5-1/2 in (140 mm)	7-21/32 in (195 mm)	7-3/32 in (180 mm)	4-7/16 in (113 mm)	1-13/16 in (46 mm)	\$175.00	\$75.00	
20 kg	12771	5-19/32 in (142 mm)	7-5/8 in (194 mm)	5-29/32 in (150 mm)	4-5/8 in (118 mm)	1-19/32 in (41 mm)	\$145.00	\$75.00	
10 kg	12767	4-1/2 in (114 mm)	6 in (152 mm)	5 in (127 mm)	3-3/4 in (95 mm)	1-1/16 in (27 mm)	\$140.00	\$75.00	

Class 7

Weight	Part #	Length	Width	Height	Price	Optional Certificate	
						Accredited	
5 kg	12786	3-13/32 in (87 mm)	5-15/32 in (139 mm)	4-1/8 (105 mm)	\$83.00	\$75.00	
2 kg	12809	2-9/16 in (65 mm)	3-31/32 in (101 mm)	2-13/16 in (71 mm)	\$70.00	\$75.00	
1 kg	12813	2-1/8 in (54 mm)	3 in (76 mm)	1-27/32 in (47 mm)	\$60.00	\$55.00	
500 g	12815	1-5/8 in (41 mm)	2-1/2 in (64 mm)	1-17/32 in (39 mm)	\$55.00	\$55.00	

OIML

Class M1

Weight	Part #	Length	Width	Height	Slot Width	Slot Depth*	Price	Optional Certificate	
								Accredited	
500 kg	156304	15-1/8 in (384mm)	15-1/8 in (384mm)	20-3/4 in (527 mm)	2-1/2 in (64 mm)	2 in (51 mm)	\$3,050.00	\$235.00	
250 kg	156305	12 in (305mm)	11-1/2 in (292mm)	17-1/2 in (445 mm)	2-1/2 in (64 mm)	1-7/8 in (48 mm)	\$1,910.00	\$235.00	
100 kg	156306	9.87 in (251 mm)	9.87 in (251 mm)	11 in (279 mm)	2-1/2 in (64 mm)	2 in (51 mm)	\$1,510.00	\$235.00	
50 kg	105417	7 in (178mm)	9-7/32 in (234 mm)	8-13/16 in (224 mm)	4-15/32 in (114 mm)	1-29/32 in (48 mm)	\$655.00	\$130.00	
20 kg	105416	5-19/32 in (142 mm)	7-5/8 in (194 mm)	5-29/32 in (150 mm)	4-5/8 in (118 mm)	1-19/32 in (41 mm)	\$155.00	\$75.00	
10 kg	105415	4-1/2 in (114 mm)	6 in (152 mm)	5 in (127 mm)	3-3/4 in (95 mm)	1-1/16 in (27 mm)	\$150.00	\$75.00	
5 kg	105414	3-13/32 in (87 mm)	5-15/32 in (139 mm)	4-1/8 in (105 mm)	-	-	\$87.00	\$75.00	

* Slot depth refers to distance between lifting bars and castings.

Accessories

Description	Part #	Price
Statement of Accuracy	36092	\$47.50
Serial number	25836	\$17.00



PN 12767 and PN 12771 OIML Grip-handle

ASTM
PRECISION

OIML
PRECISION

BALANCE
CALIBRATION

STAINLESS
FIELD WEIGHTS

CAST IRON
FIELD WEIGHTS

ASTM
SPECIALTY

ACCESSORIES

CAST IRON / SLOTTED INTERLOCKING AND HANGER

RANGE: 100 lb – 200 g

ASTM

Class 6

Slotted

Weight	Part #	Slot Width	Diameter	Height	Price
100 lb	40828	1 in (25 mm)	17 in (432 mm)	1-15/16 in (49 mm)	\$645.00
50 lb	12856	3/4 in (9 mm)	10-5/8 in (270 mm)	2-11/16 in (68 mm)	\$255.00
20 lb	12831	13/16 in (21 mm)	8-1/8 in (206 mm)	1-31/32 in (50 mm)	\$110.00

Optional Certificate

Accredited	Price
	\$105.00
	\$80.00
	\$80.00

Class 7

Slotted

Weight	Part #	Slot Width	Diameter	Height	Price
10 lb	12826	13/16 in (21 mm)	6-1/8 in (156 mm)	1-11/16 in (43 mm)	\$93.00
5 lb	12852	11/16 in (18 mm)	5-1/8 in (130 mm)	1-5/16 in (33 mm)	\$75.00
2 lb	12848	9/16 in (14 mm)	5 in (127 mm)	23/32 in (18 mm)	\$65.00
1 lb	12842	9/16 in (14 mm)	5 in (127 mm)	15/32 in (12 mm)	\$65.00
1/2 lb	12837	9/16 in (14 mm)	3-3/4 in (95 mm)	7/16 in (11 mm)	\$49.50

Optional Certificate

Accredited	Price
	\$80.00
	\$80.00
	\$65.00
	\$65.00
	\$40.00

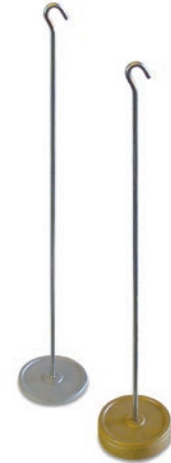

Class 7

Hanger

Weight	Part #	Capacity	Total Length	Operational Length	Diameter	Price
5 lb*	12846	500 lb	37-1/4 in (946 mm)	35 in (889 mm)	4 in (102 mm)	\$300.00
2 lb	12841	200 lb	21-13/32 in (544 mm)	19 in (483 mm)	3-3/4 in (95 mm)	\$150.00
2 lb	12835	200 lb	10-1/4 in (260 mm)	8 in (203 mm)	3-3/4 in (95 mm)	\$145.00
1 lb	12830	200 lb	21-29/32 in (556 mm)	20-7/32 in (514 mm)	3-3/4 in (95 mm)	\$130.00
1 lb	12825	200 lb	9-5/16 in (237 mm)	7-9/16 in (192 mm)	3-3/4 in (95 mm)	\$105.00

Optional Certificate

Accredited	Price
	\$80.00
	\$65.00
	\$65.00
	\$65.00
	\$65.00

* Stainless steel

Class 6

Slotted

Weight	Part #	Slot Width	Diameter	Height	Price
20 kg	12819	21/32 in (17 mm)	10-5/16 in (262 mm)	2-11/32 in (60 mm)	\$255.00
10 kg	12811	3/4 in (19 mm)	8-3/16 in (208 mm)	2-1/16 in (52 mm)	\$140.00

Optional Certificate

Accredited	Price
	\$75.00
	\$75.00

Class 7

Slotted

Weight	Part #	Slot Width	Diameter	Height	Price
5 kg	12807	13/16 in (21 mm)	6-3/16 in (157 mm)	1-13/16 in (46 mm)	\$130.00
2 kg	12799	9/16 in (14 mm)	5-1/8 in (130 mm)	1-3/16 in (30 mm)	\$75.00
1 kg	12795	9/16 in (14 mm)	5-1/16 in (129 mm)	3/4 in (19 mm)	\$66.00
500 g	12791	9/16 in (14 mm)	5 in (127 mm)	15/32 in (12 mm)	\$63.00
200 g	12780	5/8 in (16 mm)	3-21/32 in (93 mm)	7/16 in (11 mm)	\$51.00

Optional Certificate

Accredited	Price
	\$75.00
	\$75.00
	\$55.00
	\$55.00
	\$55.00

Class 7

Hanger

Weight	Part #	Capacity	Total Length	Operational Length	Diameter	Price
2 kg	12788	250 kg	37-1/4 in (946 mm)	35 in (889 mm)	4 in (102 mm)	\$300.00
1 kg	12784	100 kg	21-13/32 in (544 mm)	19 in (483 mm)	3-3/4 in (95 mm)	\$145.00
1 kg	12777	100 kg	10-1/4 in (260 mm)	8 in (203 mm)	3-3/4 in (95 mm)	\$145.00
500 g	12773	100 kg	21-29/32 in (556 mm)	20-7/32 in (514 mm)	3-3/4 in (95 mm)	\$130.00
500 g	12769	100 kg	9-5/16 in (237 mm)	7-9/16 in (192 mm)	3-3/4 in (95 mm)	\$115.00

Optional Certificate

Accredited	Price
	\$75.00
	\$55.00
	\$55.00
	\$55.00
	\$55.00

Accessories

Description	Part #	Price
Statement of Accuracy	36092	\$47.50
Serial number	25836	\$17.00



Avoirdupois

Metric

CAST IRON / COUNTERPOISE AND HANGER WEIGHTS

RANGE: 200 kg – 7 oz

ASTM

Class 7

Round

Weight	Part #	Ratio	Diameter	Fairbanks Part #	Price
50 lb x 1/2 lb	10154	1 lb - 100 lb	2-7/8 in (73 mm)	PA48	\$40.00
100 lb x 1 lb	10156	1 lb - 100 lb	4-1/16 in (103 mm)	PA32	\$45.50
200 lb x 2 lb	10158	1 lb - 100 lb	4-1/16 in (103 mm)	PA21	\$40.00
500 lb x 5 lb	10160	1 lb - 100 lb	3-3/4 in (95 mm)	Pb52	\$45.50
100 lb x 1/2 lb	10152	1/2 lb - 100 lb	2-7/8 in (73 mm)	PBC32	\$40.00
200 lb x 1 lb	10168	1/2 lb - 100 lb	3-17/32 in (90 mm)	PBC21	\$51.00
300 lb x 1 1/2 lb	10189	1/2 lb - 100 lb	3-1/2 in (89 mm)	-	\$40.00
500 lb x 2 1/2 lb	10170	1/2 lb - 100 lb	3-1/2 in (89 mm)	PBC52	\$58.00
1,000 lb x 5 lb	10196	1/2 lb - 100 lb	3-7/8 in (98 mm)	-	\$69.00

Class 7

Hexagon

Weight	Part #	Diameter	Price
10 kg x 100 g	10266	2 in (51 mm)	\$45.50
25 kg x 250 g	10268	2-13/16 in (71 mm)	\$45.50
50 kg x 500 g	10270	4 in (102 mm)	\$49.50
100 g x 1 kg	10272	4 in (102 mm)	\$55.00
200 kg x 2 kg	10274	4 in (102 mm)	\$60.00

Class 7

Square

Weight	Part #	Ratio	Diameter	Fairbanks Part #	Price
50 lb x 1/2 lb	10191	1 lb - 100 lb	2-5/16 in (59 mm)	1A2349	\$45.50
100 lb x 1 lb	10162	1 lb - 100 lb	3-1/2 in (89 mm)	1A1469	\$45.50
200 lb x 2 lb	10164	1 lb - 100 lb	3-1/2 in (89 mm)	1A1470	\$51.00
500 lb x 5 lb	10166	1 lb - 100 lb	3-1/2 in (89 mm)	1A1471	\$86.00

Round and Square

Hangers

Approx. Weight	Part #	Total Length	Operational Length	Diameter	Price
Round					
7 oz	10188	7-1/16 in (179 mm)	5-1/8 in (130 mm)	3-31/32 in (101 mm)	\$74.00
10 oz (Fairbanks® only)	10184	7-1/16 in (179 mm)	5-1/8 in (130 mm)	3-31/32 in (101 mm)	\$74.00
12 oz	10185	7-1/16 in (179 mm)	5-1/8 in (130 mm)	3-31/32 in (101 mm)	\$74.00
17 oz	10186	7-1/16 in (179 mm)	5-1/8 in (130 mm)	4 in (102 mm)	\$74.00
21 oz	10187	7-1/16 in (179 mm)	5-1/8 in (130 mm)	4 in (102 mm)	\$74.00
Square					
21 oz	10193	8-7/16 in (214 mm)	6-5/16 in (160 mm)	-	\$74.00



PN 10193 21 oz Square Hanger

PN 10185 12 oz Round Hanger

ASTM
PRECISION

OIML
PRECISION

BALANCE
CALIBRATION

STAINLESS
FIELD WEIGHTS

CAST IRON
FIELD WEIGHTS

ASTM
SPECIALTY

ACCESSORIES

CAST IRON / AVOIRDUPOIS COUNTERPOISE AND HANGER

RANGE: 500 lb – 7 oz

Class 7

Round

Weight	Part #	Diameter	Howe™ Part #	Price
50 lb x 1/2 lb	10367	3 in (76 mm)	42071831	\$51.00
100 lb x 1 lb	10369	2-7/8 in (73 mm)	42076188	\$51.00
200 lb x 2 lb	10371	2-31/32 in (75 mm)	42076189	\$51.00
300 lb x 3 lb	10373	2-31/32 in (75 mm)	42076190	\$51.00
500 lb x 5 lb	10385	3-1/8 in (79 mm)	42078947	\$51.00

Class 7 For Counting Scales

Round

Weight	Part #	Ratio	Diameter	Fairbanks Part #	Price
100 lb x 1 1/99 lb	10387	99 - 1	3 in (76 mm)	40810545	\$58.00
500 lb x 5 5/99 lb	10391	99 - 1	3-3/32 in (79 mm)	42111567	\$58.00
10 lb x 1 1/4 lb	10427	8 - 1	2-15/16 in (75 mm)	-	\$58.00
5 lb x 5/8 lb	10425	8 - 1	2-15/16 in (75 mm)	-	\$51.00
2 lb x 1/4 lb	10411	8 - 1	2-7/32 in (56 mm)	-	\$51.00
80 lb x 1 3/5 lb	10421	50 - 1	3 in (76 mm)	-	\$51.00
40 lb x 4/5 lb	10419	50 - 1	2-13/16 in (71 mm)	-	\$51.00
20 lb x 2/5 lb	10417	50 - 1	2-31/32 in (75 mm)	-	\$58.00
10 lb x 1/5 lb	10415	50 - 1	2 in (51 mm)	-	\$51.00
5 lb x 1/10 lb	10413	50 - 1	1-1/2 in (38 mm)	-	\$51.00
100 lb x 1 9/16 lb or 25 oz	10409	64 - 1	3 in (76 mm)	42111417	\$51.00
50 lb x 28/32 lb or 12 1/2 oz	10407	61 - 1	2-15/16 in (75 mm)	40807082	\$51.00
25 lb x 25/64 lb or 6 1/4 oz	10405	64 - 1	2-31/32 in (75 mm)	40807092	\$51.00
10 lb x 5/32 lb or 2 1/2 oz	10404	64 - 1	1-1/2 in (38 mm)	42111454	\$51.00

Round

Hangers

Approx. Weight	Part #	Total Length	Operational Length	Diameter	Price
7 oz	10382	8-1/4 in (210 mm)	6-3/16 in (157 mm)	2-31/32 in (75 mm)	\$69.00
10 oz	10379	8-1/4 in (210 mm)	6-3/16 in (157 mm)	2-31/32 in (75 mm)	\$69.00
12 oz	10380	8-1/4 in (210 mm)	6-3/16 in (157 mm)	2-31/32 in (75 mm)	\$115.00
16 oz	10381	8-1/4 in (210 mm)	6-3/16 in (157 mm)	2-31/32 in (75 mm)	\$115.00

Triangle

Approx. Weight	Part #	Toledo® Part #	Price
100 lb x 1 lb	11417	49868	\$40.00
200 lb x 2 lb	11419	49869	\$45.50
500 lb x 5 lb	11421	49870	\$69.00

Triangle

Hangers

Approx. Weight	Part #	Total Length	Operational Length	Toledo® Part #	Price
14 oz	11423	8-1/4 in (210 mm)	6-3/16 in (157 mm)	49857	\$69.00

Triangle Single
and Hanger

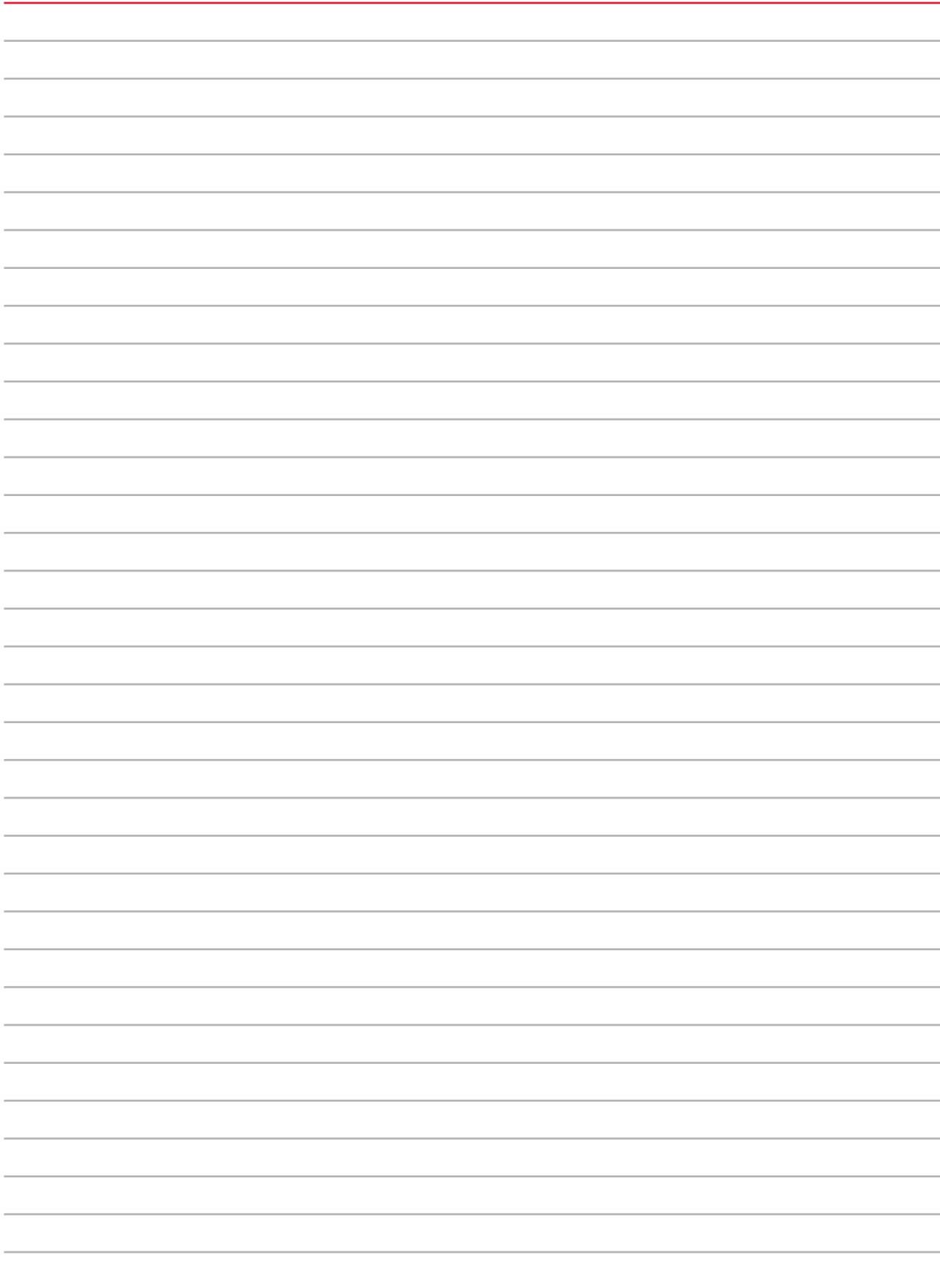

ASTM
PRECISION

OIML
PRECISION

BALANCE
CALIBRATION

STAINLESS
FIELD WEIGHTS

CAST IRON
FIELD WEIGHTS

ASTM
SPECIALTY

ACCESSORIES

ASTM Specialty Calibration Weights

Applications:

Tolerance test or checking

Equipment verification in
unique units of measurement

Slotted weights for suspended
verification of weight

Forklift weights for forklift scale calibration

Designs Available:

Cube

Ring

Lift truck weights

Hook weights

Stainless steel slotted weights

Unique Units of Measure:

Penny weight

Grain

Troy ounce

Features:

Nominal value marked on weights

Cavity for adjustment

Cube weight sets designed as sealer's kits
for calibration adjustments





*Metric Cube and Ring Weights;
Avoirdupois Ring Weights*

118 RANGE: 5 lb – 25 g

Troy Ounce Cylindrical/Leaf Weights

119 Range: 500 oz t – 0.005 oz t

*Pennyweight Cylindrical and Leaf,
and Grain Weights*

120 Range: 20 dwt – 20 gr

Specialty Weights/Cube Weights Sets

121 Range: 1kg – 1mg

*Avoirdupois and Metric
Single Hook Weights*

122 Range: 25 kg – 1/32 oz

*Avoirdupois/Metric Single
Hangers/Slotted Weights*

123 Range: 5 lb – 100 g

Lift Truck Weights and Clean Room Cart

124 Range: 50 kg - 2,000 lb

SPECIALTY CALIBRATION WEIGHTS / METRIC CUBE AND RING WEIGHTS; AVOIRDUPOIS RING WEIGHTS

RANGE: 5 lb – 25 g

Class 5

Cube

Weight	Part #	Length	Width	Height	Price	Accredited
2 lb	12649	1 in (25 mm)	2.4 in (61 mm)	3 in (76 mm)	\$165.00	\$65.00
1 lb	12651	1 in (25 mm)	1.2 in (31 mm)	3 in (76 mm)	\$150.00	\$65.00
8 oz	12653	1 in (25 mm)	1-9/10 in (48 mm)	1 in (25 mm)	\$130.00	\$55.00
2 oz	12658	0.60 in (15 mm)	0.70 in (18 mm)	1 in (25 mm)	\$93.00	\$55.00
4 oz	12655	1 in (25 mm)	73/100 in (19 mm)	309/1000 in (33 mm)	\$110.00	\$55.00
1 kg	12557	3-3/8 in (87 mm)	1 in (25 mm)	2-1/2 in (63 mm)	\$165.00	\$55.00
500 g	12552	3-13/32 in (87 mm)	1 in (25 mm)	1-1/4 in (32 mm)	\$130.00	\$55.00
300 g	12547	1-1/4 in (32 mm)	2-1/32 in (52 mm)	1 in (25 mm)	\$120.00	\$55.00
200 g	12544	1-3/8 in (35 mm)	1-1/4 in (31 mm)	1 in (25 mm)	\$110.00	\$55.00
100 g	12541	1-7/32 in (31 mm)	3/4 in (19 mm)	1 in (25 mm)	\$93.00	\$40.00

Optional Certificate

Class 5

Ring

Weight	Part #	Outside Dia.	Inside Dia.	Height	Price	Accredited
500 g	12566	3 in (76 mm)	25/64 in (10 mm)	37/64 in (15 mm)	\$140.00	\$55.00
200 g	12563	2 in (51 mm)	25/64 in (10 mm)	17/32 in (14 mm)	\$115.00	\$55.00
100 g	12561	1-1/2 in (38 mm)	25/64 in (10 mm)	1/2 in (13 mm)	\$93.00	\$40.00
50 g	12560	1-1/2 in (38 mm)	25/64 in (10 mm)	1/4 in (6 mm)	\$79.00	\$40.00
25 g	12559	1 in (25 mm)	25/64 in (10 mm)	5/16 in (8 mm)	\$62.00	\$40.00
5 lb	12672	4 in (102 mm)	25/64 in (10 mm)	1-7/16 in (37 mm)	\$125.00	\$80.00
3 lb	12671	3 in (76 mm)	25/64 in (10 mm)	1-35/64 in (36 mm)	\$100.00	\$80.00
2 lb	12670	3 in (76 mm)	25/64 in (10 mm)	1-1/32 in (26 mm)	\$79.00	\$65.00
1 lb	12669	3 in (76 mm)	25/64 in (10 mm)	33/64 in (13 mm)	\$79.00	\$65.00
8 oz	12668	2 in (51 mm)	25/64 in (10 mm)	39/64 in (16 mm)	\$38.50	\$40.00
4 oz	12667	1-1/2 in (38 mm)	25/64 in (10 mm)	9/16 in (14 mm)	\$38.50	\$40.00
2 oz	12666	1 1/2 in (38 mm)	25/64 in (10 mm)	9/32 in (7 mm)	\$38.50	\$40.00
1 oz	12665	1 in (25 mm)	25/64 in (10 mm)	11/32 in (9 mm)	\$38.50	\$40.00
1/2 oz	12664	1 in (25 mm)	25/64 in (10 mm)	11/64 in (4 mm)	\$73.00	\$40.00
1/4 oz	12663	1 in (25 mm)	25/64 in (10 mm)	3/32 in (2 mm)	\$100.00	\$40.00

Optional Certificate

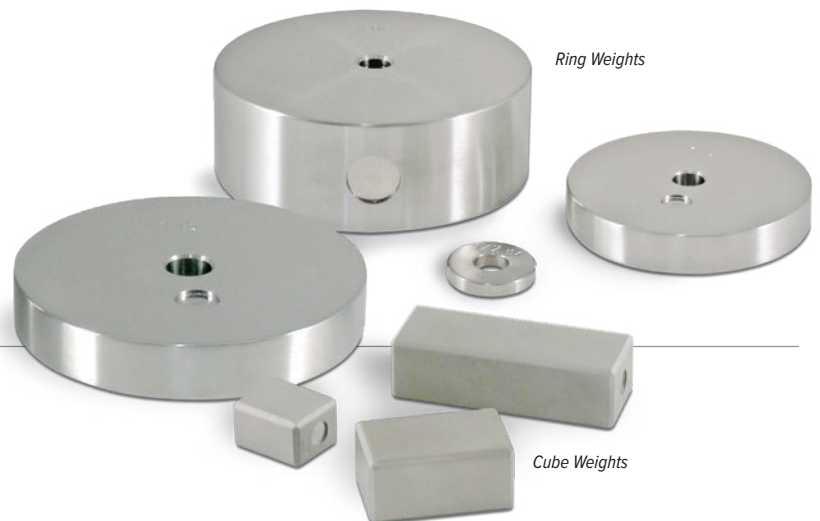

Ring Weights

Cube Weights

Accessories

Description	Part #	Price
Statement of Accuracy	36092	\$47.50
Serial number	25836	\$17.00

SPECIALTY CALIBRATION WEIGHTS / TROY OUNCE

RANGE: 500 oz t – 0.005 oz t

Class 5 Cylindrical

Weight	Part #	Height	Diameter	Price
500 oz t	12719	6-5/16 in (160 mm)	5 in (127 mm)	\$1,200.00
200 oz t	12718	3-3/4 in (95 mm)	4-25/32 in (121 mm)	\$525.00
100 oz t	12717	3-13/16 in (96 mm)	3 in (75 mm)	\$315.00
50 oz t	12716	2-5/8 in (67 mm)	2-21/32 in (68 mm)	\$185.00
20 oz t	12715	2-1/4 in (57 mm)	1-3/4 in (44 mm)	\$93.00
10 oz t	12714	1-3/8 in (35 mm)	1-29/32 in (48 mm)	\$74.00
5 oz t	12713	1-3/16 in (30 mm)	1-13/32 in (36 mm)	\$74.00
2 oz t	12712	7/8 in (22 mm)	31/32 in (25 mm)	\$43.00
1 oz t	12711	7/8 in (21 mm)	5/8 in (16 mm)	\$40.00
1/4 oz t	12709	11/16 in (17 mm)	3/8 in (9 mm)	\$48.50
1/8 oz t	12708	5/16 in (8 mm)	15/32 in (12 mm)	\$48.50
1/16 oz t	12707	3/8 in (9 mm)	1/4 in (6 mm)	\$48.50
1/32 oz t	12706	5/16 in (8 mm)	3/16 in (5 mm)	\$48.50
0.5 oz t	12705	1/2 in (13 mm)	23/32 in (18 mm)	\$48.50
0.2 oz t	12704	1/2 in (13 mm)	3/8 in (9 mm)	\$48.50
0.1 oz t	12703	5/16 in (8 mm)	13/32 in (10 mm)	\$48.50
0.05 oz t	12702	1/4 in (6 mm)	11/32 in (9 mm)	\$48.50

Optional Certificate

Accredited
\$80.00
\$80.00
\$80.00
\$80.00
\$65.00
\$40.00
\$40.00
\$40.00
\$40.00
\$40.00
\$40.00
\$40.00
\$40.00
\$40.00
\$40.00
\$40.00

Class 5 Leaf

Weight	Part #	Height	Diameter	Price
0.02 oz t	12701	W x L (0.375 in x 0.287 in)	-	\$37.50
0.01 oz t	12700	W x L (0.312 in x 0.270 in)	-	\$37.50
0.005 oz t	12699	W x L (0.25 in x 0.22 in)	-	\$37.50

Optional Certificate

Accredited
\$40.00
\$40.00
\$40.00



PN 12714 Cylindrical Weight

Accessories

Description	Part #	Price
Statement of Accuracy	36092	\$47.50
Serial number	25836	\$17.00

ASTM
PRECISION

OIML
PRECISION

BALANCE
CALIBRATION

STAINLESS
FIELD WEIGHTS

CAST IRON
FIELD WEIGHTS

ASTM
SPECIALTY

ACCESSORIES

SPECIALTY CALIBRATION WEIGHTS / PENNYWEIGHT CYLINDRICAL AND LEAF, AND GRAIN WEIGHTS

RANGE: 20 dwt – 20 gr

Class 5

Cylindrical

Optional Certificate

Weight	Part #	Price	Accredited
20 dwt	12698	\$79.00	\$40.00
10 dwt	12697	\$79.00	\$40.00
5 dwt	12696	\$79.00	\$40.00
2 dwt	12695	\$79.00	\$40.00
1 dwt	12694	\$79.00	\$40.00

Class 5

Leaf

Optional Certificate

Weight	Part #	Price	Accredited
0.5 dwt	12693	\$70.00	\$55.00
0.2 dwt	12692	\$70.00	\$55.00
0.1 dwt	12691	\$70.00	\$40.00

Class 5

Grain

Optional Certificate

Weight	Part #	Price	Accredited
1 gr	12726	\$26.50	\$55.00
2 gr	12727	\$30.00	\$55.00
10 gr	12733	\$30.00	\$40.00
20 gr	12736	\$37.50	\$40.00



PN 12693 Pennyweight Leaf Weight



PN 12695 Cylindrical

Accessories

Description	Part #	Price
Statement of Accuracy	36092	\$47.50
Serial number	25836	\$17.00

SPECIALTY CALIBRATION WEIGHTS / CUBE WEIGHTS SETS

RANGE: 1kg – 1mg

Class 5

Cube Avoirdupois

Optional Certificate

Set Size	Part #	Price	Accredited
8 oz - 1/16 oz	12630	\$340.00	\$230.00
(3) 2 lb - 1/16 oz	12652	\$1,000.00	\$379.00
(3) 2 lb - .001lb	12659	\$1,130.00	\$457.00
(14) 2 lb - 1/16 oz	12585	\$1,640.00	\$918.00

Class 5

Cube Metric

Optional Certificate

Set Size	Part #	Price	Accredited
300 g - 10 g	12545	\$345.00	\$280.00
(14) 1kg - 1mg	12553*	\$2,280.00	\$999.00
(3) 1kg - 1mg	12555*	\$1,420.00	\$645.00

Weight Set Contents

8 oz - 1/16 oz	2 lb - 1/16 oz	2 lb - 0.001lb	2 lb - 1/16 oz
12630	12652	12659	12585
1 - 8 oz*	3 - 2lb*	3 - 2lb*	14 - 2lb*
1 - 4 oz*	1 - 1lb*	1 - 1lb*	2 - 1lb*
1 - 2 oz*	1 - 8 oz*	1 - 0.3 lb	1 - 8 oz*
1 - 1oz	1 - 4 oz*	1 - 0.2 lb	1 - 4 oz*
1 - 1/2 oz	1 - 2 oz*	1 - 0.1lb	1 - 2 oz*
1 - 1/4 oz	1 - 1oz	1 - 0.05 lb	1 - 1oz
1 - 1/8 oz	1 - 1/2 oz	1 - 0.03 lb	1 - 1/2 oz
2 - 1/16 oz	1 - 1/4 oz	1 - 0.02 lb	1 - 1/4 oz
	1 - 1/8 oz	1 - 0.01lb	1 - 1/8 oz
	2 - 1/16 oz	1 - 0.005lb	2 - 1/16 oz
		1 - 0.003 lb	
		1 - 0.002 lb	
		2 - 001lb	
9 pcs. 1lb set wt.	13 pcs. 8lb set wt.	16 pcs. 7.72lb set wt.	25 pcs. 31lb set wt.

300 g - 10 g	1kg - 1mg	1kg - 1mg
12545	12553	12555
-	14 - 1kg*	3 - 1kg*
-	2 - 500 g*	1 - 500 g*
1 - 300 g*	1 - 300 g*	1 - 300 g*
1 - 200 g*	1 - 200 g*	1 - 200 g*
1 - 100 g*	1 - 100 g*	1 - 100 g*
1 - 50 g	1 - 50 g	1 - 50 g
1 - 30 g	1 - 30 g	1 - 30 g
1 - 20 g	1 - 20 g	1 - 20 g
1 - 10 g	1 - 10 g	1 - 10 g
1 - 5 g	1 - 5 g	1 - 5 g
1 - 3 g	1 - 3 g	1 - 3 g
1 - 2 g	1 - 2 g	1 - 2 g
1 - 1g	1 - 1g	1 - 1 g
1 - 500 mg	1 - 500 mg	1 - 500 mg
1 - 300 mg	1 - 300 mg	1 - 300 mg
1 - 200 mg	1 - 200 mg	1 - 200 mg
1 - 100 mg	1 - 100 mg	1 - 100 mg
1 - 50 mg	1 - 50 mg	1 - 50 mg
1 - 30 mg	1 - 30 mg	1 - 30 mg
1 - 20 mg	1 - 20 mg	1 - 20 mg
1 - 10 mg	1 - 10 mg	1 - 10 mg
	1 - 5 mg	1 - 5 mg
	1 - 3 mg	1 - 3 mg
	1 - 2 mg	1 - 2 mg
	1 - 1mg	1 - 1 mg
7 pcs. 710g set wt.	39 pcs 15,722.221g set wt.	27 pcs. 4,222.221g set wt.

*Cube Weight

Replacement Cases

Cube Avoirdupois Main Cases		
Class 5		
Set Size	Part #	Price
8 oz - 1/16 oz	11510	\$37.50
(3) 2 lb - 1/16 oz	11569	\$225.00
(3) 2 lb - .001lb	11569	\$225.00
(14) 2 lb - 1/16 oz	40783	\$360.00

Cube Metric Main Cases		
Class 5		
Size	Part #	Price
300 g - 10 g	11510	\$37.50
(14) 1kg - 1mg	40783	\$360.00
(3) 1kg - 1mg	11569	\$225.00

Inserts		
Class 5		
Size	Part #	Price
300 g - 10 g	11526	\$40.00
5 g - 1mg	11527	\$37.50
(2) 50 g - 1mg	11528	\$40.00
1kg - 1mg	11526	\$40.00
(3) 1kg - 1mg	11526	\$40.00

Accessories

Description	Part #	Price
Statement of Accuracy	36092	\$47.50
Leaf weight cover	11758	\$43.00
Tweezer	65640	\$21.00
Serial number	25836	\$17.00
Premium tweezer	152414	\$43.00

SPECIALTY CALIBRATION WEIGHTS / AVOIRDUPOIS AND METRIC SINGLE HOOK WEIGHTS

RANGE: 25 kg – 1/32 oz

Class 6

Hook Metric

Weight	Part #	Diameter	Hanging Height	Opening Diameter	Price
25 kg	12720	5-31/32 in (152 mm)	9-3/16 in (233 mm)	1/4 in (6 mm)	\$945.00
20 kg	12725	5-31/32 in (152 mm)	8-3/8 in (213 mm)	1/4 in (6 mm)	\$925.00
10 kg	12732	4 in (102 mm)	9-1/16 in (230 mm)	1/4 in (6 mm)	\$635.00
5 kg	12735	3-3/4 in (95 mm)	6-11/32 in (161 mm)	1/4 in (6 mm)	\$315.00
4 kg	161608	3-1/2 in (89 mm)	6.12 in (155 mm)	1/4 in (6 mm)	\$310.00
3 kg	96403	2-5/8 in (67 mm)	5-1/16 in (129 mm)	1/4 in (6 mm)	\$295.00
2 kg	12739	2-5/8 in (67 mm)	5-17/32 in (136 mm)	1/4 in (6 mm)	\$225.00
1 kg	12744	2 in (51 mm)	5-3/8 in (137 mm)	1/4 in (6 mm)	\$125.00
500 g	12747	1-5/8 in (41 mm)	4-1/2 in (114 mm)	5/32 in (4 mm)	\$105.00
300 g	96404	1-1/4 in (32 mm)	4-1/2 in (114 mm)	5/32 in (4 mm)	\$105.00
200 g	12748	1-1/8 in (29 mm)	3 in (76 mm)	3/32 in (2 mm)	\$105.00
100 g	12749	1 in (25 mm)	2-3/8 in (60 mm)	3/32 in (2 mm)	\$93.00
50 g	12750	3/4 in (19 mm)	2-1/4 in (57 mm)	3/32 in (2 mm)	\$93.00
30 g	96405	5/8 in (16 mm)	2-1/8 in (54 mm)	3/32 in (2 mm)	\$93.00
20 g	12751	5/8 in (16 mm)	2-1/8 in (54 mm)	3/32 in (2 mm)	\$93.00
10 g	12754	1/2 in (13 mm)	2 in (50.8 mm)	3/32 in (2 mm)	\$68.00

Optional Certificate

Accredited
\$75.00
\$75.00
\$75.00
\$75.00
\$75.00
\$75.00
\$75.00
\$55.00
\$55.00
\$55.00
\$40.00
\$40.00
\$40.00
\$40.00
\$40.00

Hook Only

Weight	Part #	Diameter	Hanging Height	Opening Diameter	Price
5 g	12757	1/8 in (3 mm)	2-5/32 in (55 mm)	3/16 in (5 mm)	\$62.00
3 g	96406	3/32 in (2 mm)	2.32 in (59 mm)	3/16 in (5 mm)	\$54.00
2 g	12762	3/32 in (2 mm)	1-7/32 in (31 mm)	3/16 in (5 mm)	\$54.00
1 g	12766	1/16 in (2 mm)	1-21/32 in (42 mm)	3/16 in (5 mm)	\$54.00

Optional Certificate

Accredited
\$40.00
\$40.00
\$40.00
\$40.00

Class 6

Hook Avoirdupois

Weight	Part #	Diameter	Hanging Height	Opening Diameter	Price
50 lb	12894	5-31/32 in (152 mm)	9-1/4 in (235 mm)	1/4 in (6 mm)	\$945.00
25 lb	96408	4-19/32 in (117 mm)	5-3/4 in (146 mm)	1/4 in (6 mm)	\$855.00
20 lb	12895	4 in (102 mm)	9-3/16 in (233 mm)	1/4 in (6 mm)	\$615.00
10 lb	12896	3-1/2 in (89 mm)	6-1/4 in (159 mm)	1/4 in (6 mm)	\$310.00
5 lb	12897	2-5/8 in (67 mm)	6-1/2 in (165 mm)	1/4 in (6 mm)	\$215.00
3 lb	96409	2-1/4 in (57 mm)	4-1/32 in (102 mm)	1/4 in (6 mm)	\$200.00
2 lb	12898	2 in (51 mm)	5 in (127 mm)	1/4 in (6 mm)	\$125.00
1 lb	12899	1-5/8 in (41 mm)	4-1/2 in (114 mm)	5/32 in (4 mm)	\$93.00
0.2 lb	96410	1 in (25 mm)	2-5/16 in (59 mm)	3/32 in (2 mm)	\$79.00
0.1 lb	96411	3/4 in (19 mm)	2-5/32 in (55 mm)	3/32 in (2 mm)	\$79.00
8 oz	12900	1-1/4 in (32 mm)	4 in (102 mm)	5/32 in (4 mm)	\$79.00
4 oz	12901	1 in (25 mm)	2-1/4 in (57 mm)	3/32 in (2 mm)	\$79.00
2 oz	12902	13/16 in (21 mm)	2-1/4 in (57 mm)	3/32 in (2 mm)	\$79.00
1 oz	12903	5/8 in (16 mm)	2-1/4 in (57 mm)	3/32 in (2 mm)	\$79.00
1/2 oz	12904	17/32 in (14 mm)	2-29/32 in (74 mm)	3/32 in (2 mm)	\$73.00

Optional Certificate

Accredited
\$80.00
\$80.00
\$80.00
\$80.00
\$80.00
\$80.00
\$65.00
\$65.00
\$40.00
\$40.00
\$40.00
\$40.00
\$40.00
\$40.00
\$40.00

Hook Only

Weight	Part #	Diameter	Hanging Height	Opening Diameter	Price
1/4 oz	12905	5/32 in (4 mm)	1-13/16 in (46 mm)	3/16 in (5 mm)	\$54.00
1/8 oz	12906	1/8 in (3 mm)	1-1/8 in (27 mm)	3/16 in (5 mm)	\$54.00
1/16 oz	12907	3/32 in (2 mm)	1-1/4 in (32 mm)	3/16 in (5 mm)	\$54.00
1/32 oz	12908	1/16 in (2 mm)	1-13/32 in (36 mm)	3/16 in (5 mm)	\$54.00

Optional Certificate

Accredited
\$40.00
\$40.00
\$40.00
\$40.00



Hook (only) Weight (5g - 1g and (1/4-1/32 oz)

Accessories

Description	Part #	Price
Statement of Accuracy	36092	\$47.50
Serial number	25836	\$17.00



Hook Weights

SPECIALTY CALIBRATION WEIGHTS / AVOIRDUPOIS/METRIC SINGLE HANGERS/SLOTTED WEIGHTS

RANGE: 5 lb – 100 g

Class 7

Stainless Steel Hanger

Weight	Part #	Length	Diameter	Total Cap	Price
5 lb	12846	37 1/4 in	4 in (102 mm)	500 lb	\$300.00
3 kg	156937	38 3/16 in	4 in (102 mm)	250 kg	\$310.00

Optional Certificate

Accredited
\$80.00
\$75.00

Class 5

Slotted Avoirdupois

Weight	Part #	Diameter	Height	Slot Width	Price
10 lb	12589	4 in (102 mm)	3-1/8 in (79 mm)	1/2 in (13 mm)	\$600.00
5 lb	12586	4 in (102 mm)	1-9/16 in (40 mm)	1/2 in (13 mm)	\$375.00
2 lb	12577	3 in (76 mm)	1-9/64 in (29 mm)	1/2 in (13 mm)	\$235.00
1 lb	12574	3 in (76 mm)	19/32 in (15 mm)	1/2 in (13 mm)	\$200.00
8 oz	12583	2 in (51 mm)	45/64 in (18 mm)	1/2 in (13 mm)	\$175.00
4 oz	12580	1-1/2 in (38 mm)	11/16 in (18 mm)	1/2 in (13 mm)	\$135.00

Optional Certificate

Accredited
\$80.00
\$80.00
\$65.00
\$65.00
\$40.00
\$40.00

Class 5

Slotted Metric

Weight	Part #	Diameter	Height	Slot Width	Price
5 kg	156931	4 in (102 mm)	3-1/8 in (79 mm)	1/2 in (13 mm)	\$555.00
2 kg	156932	4 in (102 mm)	1-9/16 in (40 mm)	1/2 in (13 mm)	\$385.00
1 kg	156933	3 in (76 mm)	1.27 in (32 mm)	1/2 in (13 mm)	\$225.00
500 g	156934	3 in (76 mm)	0.836 in (21 mm)	1/2 in (13 mm)	\$205.00
200 g	156935	1-1/2 in (38 mm)	0.801 in (20 mm)	1/2 in (13 mm)	\$170.00
100 g	156936	1-1/2 in (38 mm)	0.601 in (15 mm)	1/2 in (13 mm)	\$110.00

Optional Certificate

Accredited
\$75.00
\$75.00
\$55.00
\$55.00
\$55.00
\$40.00



Slotted

Accessories

Description	Part #	Price
Statement of Accuracy	36092	\$47.50
Serial number	25836	\$17.00

ASTM
PRECISION

OIML
PRECISION

BALANCE
CALIBRATION

STAINLESS
FIELD WEIGHTS

CAST IRON
FIELD WEIGHTS

ASTM
SPECIALTY

ACCESSORIES

SPECIALTY CALIBRATION WEIGHTS / LIFT TRUCK WEIGHTS AND CLEAN ROOM CART

RANGE: 50 kg – 2,000 lb

Painted Steel Lift Truck Weights

Class 6

Optional Certificate

Weight	Part #	Price	Accredited
1,000 lb	120160	\$2,650.00	\$235.00
2,000 lb	120162	\$7,875.00	\$235.00

Dimensions

PN 120160		PN 120162	
A	38.25 in	A	34.25 in
B	6.0 in	B	6.0 in
C	22.5 in	C	22.5 in
D	46.25 in	D	46.25 in

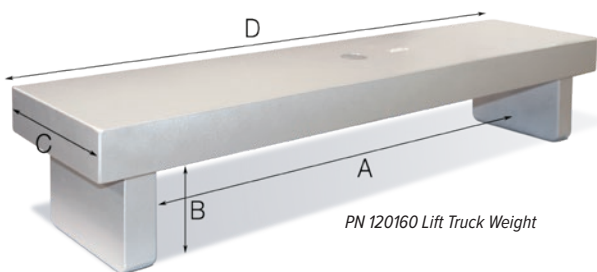

Stainless Steel Clean Room Weight Cart

Class 6

Optional Certificate

Weight	Part #	Description	Price	Accredited
50 kg	178045	16 x 16 in	\$5,025.00	\$235.00
100 kg	180033	16 x 16 in	\$5,650.00	\$235.00
200 kg	180624	16 x 16 in	\$7,025.00	\$235.00
250 kg	180625	18 x 18 in	\$8,900.00	\$235.00
500 kg	180034	18 x 18 in	\$15,850.00	\$235.00

Clean Room, Weigh Cart
(Calibration Optional)

Accessories & Cases

Guidelines for Selecting a Case:

Find the diameter, height,
and total mass of the weights
that will need a case

Review case dimensions
to determine best fit

Note weight limits of the case
and choose accordingly

Things to keep in mind:

Foam needs 0.5 inches between weights and
edge of case

Always select the smallest case best fitting your need

Weights should always be stored and transported
in the upright position

The shoulder edge of the weight should be level
with the foam insert

Some cases are recommended for storage only and
should not be used for shipping



Accessories & cases

- 124** Cases
- 126** Sealing Plugs
Canvas Dust Covers
Gloves
- 127** Transfer Equipment
Transfer Cart
Touch-Up Paint

CASES

Industrial-Quality Cases

These heavy-duty cases are designed to be used in place of large wooden cases when portability is desired. The recessed latches provide protection assurance for your weights.

Pelican Cases

- Pick N Pluck™ with convoluted lid foam
- Watertight, crushproof and dustproof
- Durable, lightweight container design
- Rubber over-molded handle
- Secure, integrated latches
- Stainless steel padlock protectors
- Custom inserts available upon request

Black Thermoformed Cases

- Excellent for transporting weights
- Recessed, heavy-duty latches confidently secure contents
- Ergonomic handles retain preferred treatment of weights
- Metal hardware resists natural wear and tear
- Special case cuttings are required for heavy duty cases at an additional charge

Black Injection-Molded Watertight Case

- Designed for custom weight sets
- Ergonomic top-mounted handle provides ideal weight positioning
- Interior is custom-molded to the weights to be stored

Medium-Duty Cases

Medium-duty cases are primarily used for manually transporting test weights as they effectively absorb shock and resist changes in environment.

ABS Plastic

- ABS plastic is considered superior for its strength, gloss, and electrical insulation properties—an excellent choice for encasing weights
- All metal hardware establishes the security of your weights
- Top-mounted handle makes transporting the weights effortless
- Custom-cut foam inserts are used for insulating between the weights
- Three sizes available

Wooden Cases

(Other cases and sizes available by custom order)

- Walnut-constructed and felt-lined
- Built-to-order and designed specifically for your weight sets
- Not available as an accessory purchase
- Available in 5 kg-20 kg capacities
- Secured by hinged latches
- Case keeps weights free of dust and contaminants
- Protects your weights in storage and during transportation
- Cases should be packed in an external box during shipping to protect them

PVC Cases

(Other cases and sizes available by custom order)

- Available in capacities from 100 g-1 mg for Precision Mass Reference Standards
- Also available for ASTM Class 0 weights in 100 g-1 mg capacities



Pelican Cases

Length	Width	Closed Height	Max Load	Part #	Price
17 in	22 in	8 in	75 lb	21230	\$420.00
11.75 in	17 in	6 in	50 lb	21229	\$285.00

Black Thermoformed Cases

Length	Width	Closed Height	Max Load	Part #	Price
22.4 in	16.3 in	10.5 in	95 lb	156989	\$845.00
16.4 in	11.4 in	9 in	55 lb	156285	\$570.00
9.9 in	9.9 in	11 in	60 lb	156284	\$455.00

Black Injection-Molded Watertight Case

Length	Width	Closed Height	Max Load	Part #	Price
12.63 in	9.5 in	4.75 in	20 lb	158121	\$325.00



ABS Plastic

Length	Width	Closed Height	Max Load	Part #	Price
7.625 in	13.5 in	6 in	40 lb	11531	\$250.00
9.375 in	14.375 in	7.625 in	55 lb	11534	\$260.00
6.5 in	8.375 in	7.125 in	25 lb	11572	\$190.00



ABS Plastic Case (Weights shown are not included with case)

CASES

Light-Duty/Single Weight Cases

Light-duty/single weight cases can be used for storage and shipping smaller capacity weights within additional materials.

Plastic

- Light-duty plastic cases are used for shipping lighter capacity weights—typically single weights not exceeding 5 lb
- Plastic hinges, latches, and side-mounted handle keep this case extremely lightweight and portable
- Uncut foam is included while custom-cut is available for an extra charge
- Custom-cut foam insert protects each weight from impact during transport

Leatherette

- Secure storage of single weights with snap lid
- Considered light-duty and used for storage and shipping
- Leatherette is a non-porous material—ideal for weight protection
- Two sizes of leatherette cases available

Clean Room

Acrylic

- Ideal for all clean room environments
- Tough, clear acrylic protects your valuable investment
- Provide compliance for stringent clean room requirements
- Not recommended for shipping, developed exclusively for storage
- Available as an accessory only
- Optional custom inserts available up request

Polycarbonate Cases

- Light-duty cases for single weights
- Suitable for clean room storage and shipping lighter capacity weights
- Three case sizes with different insert sizes
- Transparent lid for easy weight identification
- Secure-latch lid for weight protection



PN 34645



PN 11596

Wooden and PVC

Description	Part #	Price
PVC case for precision laboratory mass reference standards, 100 g-1 mg range (5-2-2-1 configuration)	11596	\$180.00
Wooden case built-to-order for field standards and balance calibration weights, 500 g-1 mg range	34645	\$330.00



PN 87982

PN 69229

Polycarbonate Case

Plastic

Length	Width	Closed Height	Max Load	Part #	Price
8 in	12 in	3.5 in	5 lb	87982	\$81.00

Leatherette

Length	Width	Closed Height	Max Load	Part #	Price
1.875 in	3.75 in	1.0625 in	3 lb	69429	\$37.50
2.5 in	3.4375 in	.875 in	1 lb	69229	\$37.50



PN 89180 and PN 89179
Shown with optional insert

Acrylic Clean Room

Length	Width	Closed Height	Part #	Price
3.04 in	6.04 in	1.8 in	89179	\$125.00
4.7 in	8.7 in	2.8 in	89180	\$230.00
5.25 in	12 in	4 in	89181	\$365.00
8.5 in	13.25 in	5.75 in	89182	\$575.00
PVC Insert			Consult	Consult

Polycarbonate

Length	Width	Closed Height	Part #	Price
4.25 in	4.25 in	4.875 in	Consult	\$32.00
3.12 in	3.12 in	3.61 in	Consult	\$32.00
2.25 in	2.25 in	2.45 in	Consult	\$35.00

Sealers Cube Wt - with precut foam insert

Length	Width	Closed Height	Part #	Price
9.375 in	14.375 in	7.625 in	40783	\$360.00

Protection Containers

Description	Part #	Price
Capsule	80420	\$5.00
Vial	50038	\$5.00

ASTM
PRECISION

OIML
PRECISION

BALANCE
CALIBRATION

STAINLESS
FIELD WEIGHTS

CAST IRON
FIELD WEIGHTS

ASTM
SPECIALTY

ACCESSORIES

SEALING PLUGS

Lead

Diameter	Part #	Price
2.75 in (69.8 mm)	11749	\$5.50
1.875 in (47.6 mm)	11750	\$5.00
1 in (25.4 mm)	11751	\$4.50
0.5 in (12.7 mm)	11752	\$4.50
1.25 in (31.7 mm)	11753	\$4.50
0.5626 in (14.3 mm)	11760	\$4.50
0.625 in (15.9 mm)	11761	\$4.50
0.75 in (19.1 mm)	11765	\$4.50
0.875 in (22.2 mm)	11785	\$4.50

Aluminum

Diameter	Part #	Price
0.375 in (9.5 mm)	11744	\$2.50
0.5 in (12.7 mm)	11745	\$2.50
0.625 in (15.9 mm)	11746	\$2.50
1 in (25.4 mm)	11762	\$2.50
0.5626 in (14.3 mm)	11767	\$4.50
0.875 in (22.2 mm)	11775	\$4.00
0.75 in (19.1 mm)	11776	\$2.50

Backup

Diameter	Part #	Price
2.75 in (69.8 mm)	11748	\$6.25
.75 in (19.1 mm)	11766	\$4.50
1 in (25.4 mm)	11710	\$2.50
1.875 in (47.6 mm)	11699	\$2.50

Backup Stainless Steel

Diameter	Part #	Price
1 in (25.4 mm)	44992	\$2.50
.625 in (15.9 mm)	44993	\$5.00
.325 in (9.5 mm)	44994	\$5.50

Stainless Steel

Diameter	Part #	Price
.9375 in (23.0 mm)	11709	\$4.50



CANVAS DUST COVERS

Canvas Dust Covers

Weight	Part #	Capacity	Cover Part #	Price
12890	200 lb	11720	\$220.00	
12844	500 lb	11722	\$220.00	
12880	750 lb	11723	\$220.00	
12850	1,000 lb	11724	\$220.00	
12858	1,250 lb	11727	\$220.00	
12866	2,000 lb	11729	\$220.00	

Weight	Part #	Capacity	Cover Part #	Price
12817	100 kg	11738	\$220.00	
12782	250 kg	11740	\$220.00	
12797	500 kg	11741	\$220.00	
12801	1,000 kg	11742	\$220.00	
12821	2,000 kg	11743	\$220.00	



GLOVES

Cotton 11714

- Essential tool for proper weight-handling
- Proper protection for preventing hand residue
- Residue can impact a weight's calibration and certification for accuracy
- Rice Lake recommends using cotton gloves to handle all precision weights



Vinyl 11773

- Vinyl gloves are an acceptable handling tool to keep dirt and residue off your weights
- Better than handling precision weights bare-handed
- Vinyl gloves are economical, disposable, convenient, and help maintain the integrity of your weights



Gloves

Description	Part #	Price
Cotton glove	11714	\$6.75
Vinyl glove	11773	\$3.25

TRANSFER EQUIPMENT

Transfer Equipment

Set Size	Part #	Price
Forceps, 3.625 in 100 g - 1 mg	11711	\$5.00
Forceps, 4.75 in	50035	\$43.00
Plastic bar 200 g - 3 kg, screw knob weights	11747	\$21.00
Metal handle 5 kg +, screw knob weights	11712	\$73.00
Metal forceps <i>Not recommended for use with polished weights.</i>	65640	\$21.00
Weight lifter, OIML 2 kg and 5 kg	50037	\$54.00
Tong assembly, 24 cm x 7.5 cm	50000	\$74.00
Tweezers, premium, 140 mm	152414	\$43.00
Tweezers, premium, 220 mm	157109	\$48.50



TRANSFER CART

Transfer Cart

Description	Part #	Price
36.5 x 74.5 x 29 in (927.1 x 1892.3 x 736.6 mm) <i>For use on smooth, level surfaces—especially for moving 500 or 1,000 lb heavy-capacity weights.</i>	11700	\$1,720.00
25 x 37.5 x 14.5 in (635 x 952.5 x 368.3 mm) <i>For use on smooth, level surfaces—for holding up to fifteen 50 lb grip-handle weights.</i>	11702	\$1,970.00

Hook Replacement Parts

Description	Part #	Price
Short hook for 1,000 lb weight	22643	\$45.50
Long hook for 500 lb weight	22644	\$45.50

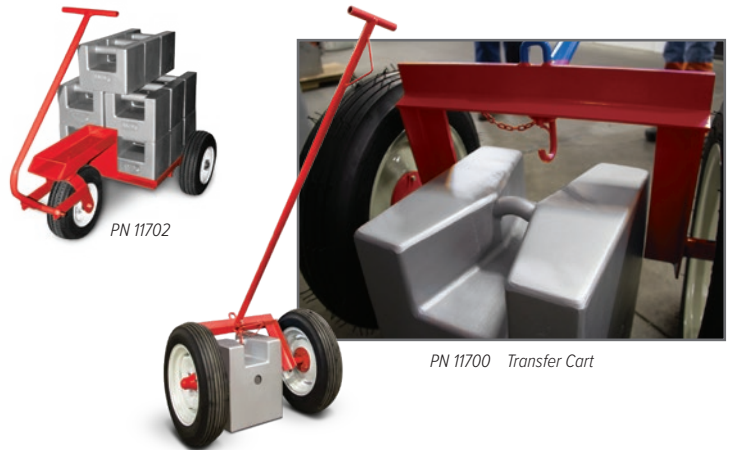

TOUCH-UP PAINT

Touch-up/Repair Paint

Ships UPS ground only

Description	Part #	Price
Aerosol spray (gold)	88561	\$32.00
Aerosol spray (silver)	88562	\$32.00
Aerosol spray (primer)	88563	\$32.00



ASTM
PRECISION

OIML
PRECISION

BALANCE
CALIBRATION

STAINLESS
FIELD WEIGHTS

CAST IRON
FIELD WEIGHTS

ASTM
SPECIALTY

ACCESSORIES



RICE LAKE

Analytical

130 TA Plus

Legal For Trade

131 TE Enhanced Series

Toploader

132 TS Series Washdown

133 TP Series

134 TC Series

135 Equipoise® Series

A&D WEIGHING

Mass Comparator

136 MC Series

Micro / Semi-Micro

137 Ion BM Series

138 Phoenix GH Series

139 Gemini GR Series

Analytical

140 Ion BM Series

141 Phoenix GH Series

142 Gemini GR Series

143 HR-AZ/A Series

144 Orion HR Series

145 AD-4212A Series

146 Apollo GF Series

147 Apollo GX Series

Legal For Trade

148 GF-P Series

149 FX-i Series

150 EK-i Series

151 EW-i Series

Precision

152 Apollo GX Series

153 Apollo GF Series

154 FX-iWP Series Washdown

155 FX-i Series

156 AD-4212A Series

Toploader

157 FX-i Series

158 Apollo GX Series

159 Apollo GF Series

160 FX-iWP Series Washdown

161 EJ Newton Series

162 EK-i Series

163 EW-i Series

High Capacity

164 GX-M Series

165 GF-M Series

166 GP Series

167 GP Series

Intrinsically Safe

168 EK-AEP Series

Moisture Analyzers

169 MS-70 / MX-50 / MF-50 / ML-50

Static Eliminator

170 AD-1683

OHAUS

Semi-Micro

171 Explorer® Series

Analytical

172 Pioneer® PX Series

173 Explorer® Series

174 Adventurer® Series

Legal For Trade

175 Scout® SJX Series

176 Valor® 7000 Series

177 Adventurer® Series

Precision

178 Adventurer® Series

179 Pioneer® PX Series

180 Explorer® Series

181 Scout® Series

Toploader

182 Pioneer® PX Series

183 Explorer® Series

184 Adventurer® Series

185 Navigator™ XT Series

186 Scout® Series

187 Scout® Series

188 Valor® 3000 Xtreme Series

189 Valor® 3000 Xtreme Series

Washdown

190 Valor® 2000 Series Washdown

191 Compass CX Series

192 Compass CR Series

193 HH Series

194 YA Series

195 Valor® 1000 Series

High Capacity

196 Explorer® Series

Mechanical

197 Triple Beam

198 Harvard Trip Balance

199 Dial-O-Gram® and
Cent-O-Gram®

200 Field Test Scale

200 Heavy Duty Solution

Moisture Analyzer

201 MB Series

SARTORIUS

Ultra-Micro / Micro

202 Cubis® II Series MCA

203 Cubis® II Series MCE

Semi-Micro

204 Cubis® II MCA Series

205 Cubis® II MCE Series

206 Quintix / Secura Series

Analytical

207 Practum / Quintix /
Secura Series

208 Cubis® II MCA Series

209 Cubis® II MCE Series

210 Entris II Series Basic Essential

211 Entris II Series Basic Advanced

Legal For Trade

212 Secura Series

213 Entris II Series Basic Essential

Precision

214 Cubis® II Series MCA

215 Cubis® II Series MCE

216 Entris II Series Basic Essential

217 Entris II Series Basic Advanced

218 Practum / Quintix / Secura
Series

219 Practum / Quintix / Secura
Series

Toploader

220 Cubis® II Series MCA

221 Cubis® II Series MCE

222 Entris II Series Basic Essential

223 Entris II Series Basic Advanced

Moisture Analyzer

224 MA35, MA37 and MA160 Series

ACCESSORIES

225 AbleCable®

226 Go-Between™

227 Kasota Stone Balance Slab

227 Kasota Stone Balance Table

227 Granite Clean Room Table

228 Anti-Vibration Pad

228 Scoops

229 Static Controlw

ANALYTICAL TA PLUS

Standard Features

- Internal calibration
- Anti-electrostatic 360° transparent windshield
- Eight-digit, 16.5 mm high liquid crystal display (LCD) with backlight
- Single-touch response setting for environment
- 40-step bar graph display
- RS-232 interface for connecting to printer or PC
- ISO/GLP/GMP compliant printing record
- Underweigh hook included
- Plastic housing

Specifications

Weighing Units

Carat, Pennyweight, Troy Ounce, Decimal Ounce, Decimal Pound (See technical manual for complete listing)

Operating Modes

Counting, Percentage, Limit Function (Checkweighing), Specific Gravity

Power

120 VAC adapter

RS232

Baud rate - 1200/2400/4800/9600/19200 bps, 8/7 data bits, Parity bit-None/Odd/Even

Calibration Weight

TA Plus-124: 120 g
TA Plus-224: 220 g

Operating Temperature

50° F to 86° F (10° C to 30° C) 80% RH or lower

Est. Weight

6.4 lb (2.9 kg)

Warranty

Five-year limited warranty

Return Policy

Rice Lake Standard Policy

Model	Capacity	Readability	Repeatability	Linearity	Pan Size	Weighing Chamber	Dimensions	Part #	List Price
TA Plus-124	120 g	0.0001 g	1 division	1 division	Ø 3.15 in (80 mm)	225 mm H × 213 mm W × 213 mm D	11 × 7.9 × 12 in (290 × 200 × 306 mm)	196569	\$2,035.00
TA Plus-224	220 g	0.0001 g	1 division	1 division	Ø 3.15 in (80 mm)	225 mm H × 213 mm W × 213 mm D	11 × 7.9 × 12 in (290 × 200 × 306 mm)	196570	\$2,055.00

Options/Accessories

Part #	Description	Price
108255	115 VAC adapter	\$52.00
108256	230 VAC adapter	\$79.00
108257	In-use cover	\$52.00
107398	Additional operating manual	\$16.00
75351	WinWedge® Tal software	\$345.00
66535	Null modem cable	\$46.00
119919	AbleCable, requires null modem cable PN 66535	\$190.00



Standard Features

- External weight calibration
- Seven-segment (main)/16-segment (sub) display
- Selectable modes: Weighing, Counting, Percentage, Coefficient, Specific Gravity, Statistics, Animal and Formulation
- Mono-metal tuning fork technology (MMTF) provides quick response and stability
- 30-step bar graph display
- AA dry-cell port, (150 hours continuous use with LCD backlight and communication signal ON)
- RS-232 interface for connecting to printer or PC
- Glass breeze break (TE-223 and TE-623 only)

Specifications

Weighing Units

Milligram, Gram, Ounce, Pound, Carat, Pennweight, Troy Ounce (See technical manual for complete listing)

Operating Modes

Weighing, Counting, Percentage, Coefficient, Specific Gravity, Statistics, Animal, Formulation

Power

100-240 VAC adapter, AA dry cell (batteries not included)

Operating Temperature

41° F to 95° F (5° C to 35° C)

Est. Weight

TE-223 / 322NC: 6.5 lb (3 kg)
TE-623 / 3202 / 6202 / 15001 / 1501NC / 8200NC: 6.0 lb (2.7 kg)

Warranty

Five-year limited warranty

Return Policy

Rice Lake Standard Policy

Approvals

NTEP Certified CC 17-104
Measurement Canada AM-6169



Model	Capacity	Resolution	NTEP Resolution	Pan Size	Weighing Chamber	Dimensions	Part #	List Price
NTEP Certified Only								
TE-223	220 g	0.001 g	0.01 g	4.6 in (118 mm)	226 mm H x 150 mm W x 150 mm D	10.6 x 8.1 x 11.8 in (270 x 208 x 301 mm)	187600	\$1,082.00
TE-623	620 g	0.001 g	0.01 g	4.6 in (118 mm)	N/A	10.6 x 8.1 x 11.8 in (270 x 208 x 301 mm)	186030	\$1,422.00
TE-3202	3,200 g	0.01 g	0.1 g	6.3 x 7.1 in (160 x 180 mm)	N/A	10.4 x 7.5 x 3.4 in (265 x 191.5 x 86 mm)	186035	\$1,180.00
TE-6202	6,200 g	0.01 g	0.1 g	6.3 x 7.1 in (160 x 180 mm)	N/A	10.4 x 7.5 x 3.4 in (265 x 191.5 x 86 mm)	186036	\$1,450.00
TE-15001	15,000 g	0.1 g	1.0 g	6.3 x 7.1 in (160 x 180 mm)	N/A	10.4 x 7.5 x 3.4 in (265 x 191.5 x 86 mm)	186037	\$1,135.00
NTEP Certified and Measurement Canada Approved								
TE-322NC	320 g	0.01 g	0.01 g	4.6 in (118 mm)	226 mm H x 150 mm W x 150 mm D	10.6 x 8.1 x 11.8 in (270 x 208 x 301 mm)	204688	\$1,050.00
TE-1501NC	1,500 g	0.1 g	0.1 g	6.3 x 7.1 in (160 x 180 mm)	N/A	10.4 x 7.5 x 3.4 in (265 x 191.5 x 86 mm)	204689	\$1,145.00
TE-8200NC	8,200 g	1 g	1 g	6.3 x 7.1 in (160 x 180 mm)	N/A	10.4 x 7.5 x 3.4 in (265 x 191.5 x 86 mm)	204690	\$1,150.00

Options/Accessories

Part#	Description	Price
186074	Power supply 100-240 VAC, 50-60 Hz	\$67.00
186075	In-use dust cover 623 g models and lower	\$27.00
186076	In-use dust cover 3,200 g models and higher	\$27.00
186077	Specific Density Measurement Kit	\$620.00
186079	Ethernet TCP/IP option card	\$620.00



TOPLOADER

TS Series Washdown

Standard Features

- Stainless steel, IP65 top housing
- Large, 18 mm liquid crystal display (LCD) with backlight
- Selectable modes
- 13 units of measurement
- Mono-metal tuning fork sensor (MMTS) provides quick response and stability
- Washdown with IP65 rating
- 115 VAC adapter included (230 VAC optional)
- Semi-automatic calibration, external weight
- RS-232 interface for connecting to printer or PC

OPTIONS:

- Battery holder
- Underweigh hook
- Waterproof RS-232 cable

Specifications**Weighing Units**

Carat, Pennyweight, Troy Ounce, Decimal Ounce, Decimal Pound (See technical manual for complete listing)

Operating Modes

Weight, Count, Percentage, Limit Function (Checkweighing)

Power

120 VAC (adapter included)

Battery Option

Nickel Cadmium battery, 12-hour run time, 24-hour charge time

RS-232 Baud Rate

1200/2400/2800/9600;
Data bits - 8, Connector - DIN 5-Pin

Calibration Weight

TP-620: 600 g
TP-6200: 6,000 g
TP-8200: 8,000 g

Operating Temperature

41° F to 95° F (5° C to 35° C)

Est. Weight

6.2 lb (2.8 kg)

Warranty

Five-year limited warranty

Return Policy

Rice Lake Standard Policy

Model	Capacity	Resolution	Calibration	Part #	List Price
TS-620	620 g	0.01 g	600 g	108156	\$1,365.00
TS-6200	6,200 g	0.1 g	6,000 g	108157	\$1,475.00
TS-8200	8,200 g	0.1 g	8,000 g	112182	\$1,550.00

Options/Accessories

Part#	Description	Price
108499	AC adapter, multi-range 110:230 VAC, 6 VDC	\$52.00
72440	9-pin D-sub F-25-Pin D-sub connector	\$67.00
22436	9-pin D-sub F to blunt end	\$67.00
66535	Null modem cable	\$46.00
119064	Slimline adapter, null modem gender changer	\$11.00
109236	Underweigh hook	\$27.00
109238	Waterproof RS-232 cable	\$360.00
109050	Additional operating manual	\$16.00
112611	Battery operator manual	\$6.00
112516	Battery holder option, requires Four AA batteries (not included)	\$105.00
119919	AbleCable, requires null modem cable PN 66535	\$190.00



PN 108499 Multi-range AC adapter and multi-plug



Standard Features

- External weight calibration
- Large, 16.5 mm-high backlit liquid crystal display (LCD)
- Mono-metal tuning fork sensor (MMTS) provides quick response and stability
- 20-step bar graph display
- One part in 620,000 resolution
- RS-232 interface for connecting to printer or PC
- Plastic housing on models <1,000 g
- Plastic top and die cast bottom on models >1,000 g

OPTIONS

- Rechargeable battery
- Under-hook weighing

Specifications

Weighing Units:

Carat, Pennyweight, Troy Ounce, Decimal Ounce, Decimal Pound (See technical manual for complete listing)

Operating Modes:

Weight, Count, Percentage, Limit Function (Check-weighing)

Power:

120 VAC (adapter included)

Battery Option:

Nickel Cadmium battery, 12-hour run time, 24-hour charge time

RS-232 Baud Rate:

1200/2400/2800/9600; Data bits - 8, Connector - DIN 5-Pin

Calibration Weight:

TP-220: 200 ?g
TP-820: 800 ?g
TP-3200: 3,000 ?g
TP-8200: 8,000 ?g
TP-12K: 12,000 ?g

Operating Temperature:

41° F to 95° F (5° C to 35° C)

Est. Weight:

6.2 lb (2.8 kg)

Warranty:

Five-year limited

Return Policy:

Rice Lake Standard Policy

Model	Capacity	Readability	Repeatability	Linearity	Pan Size	Weighing Chamber	Dimensions	Part #	List Price
TP-220	220 g	0.001 g	1 division	1 division	Ø 4.6 in (116.8 mm)	170mm W × 140 mm D × 95 mm H	9.2 × 7.1 × 6.6 in (including windshield) (235 × 182 × 170 mm)	107244	\$1,050.00
TP-820	820 g	0.01 g	1 division	1 division	6.6 in × 5.5 in (167.6 × 139.7 mm)	N/A	9.2 × 7.1 × 2.9 in (235 × 182 × 75 mm)	107245	\$1,050.00
TP-3200	3,200 g	0.01 g	1 division	1 division	7 in × 6.2 in (177.8 × 157.5 mm)	N/A	10.1 × 7.5 × 3.4 in (265 × 192 × 87 mm)	107246	\$1,190.00
TP-8200	8,200 g	0.1 g	1 division	1 division	7 in × 6.2 in (177.8 × 157.5 mm)	N/A	10.1 × 7.5 × 3.4 in (265 × 192 × 87 mm)	107247	\$1,050.00
TP-12K	12,000 g	0.1 g	1 division	1 division	7 in × 6.2 in (177.8 × 157.5 mm)	N/A	10.1 × 7.5 × 3.4 in (265 × 192 × 87 mm)	107248	\$1,210.00

Options/Accessories

Part #	Description	Price
107249	Rechargeable battery ≤TP-820	\$105.00
107237	Rechargeable battery ≥TP-3200	\$105.00
107250	In-use dust cover ≥TP-3200	\$27.00
107240	In-use dust cover ≤TP-820	\$27.00
109236	Underweigh hook ≤TP-820	\$27.00
109292	Underweigh hook ≥TP-3200	\$27.00
42566	115 VAC adapter/12 VDC	\$68.00
42168	230 VAC adapter	\$74.00
107251	Additional operating manual	\$16.00
75351	WinWedge® Tal software	\$345.00
115303	5-pin to 9-pin DB female RS-232 cable	\$98.00



TOPLOADER TC Series

Standard Features

- Large, 16.5 mm-high, backlit liquid crystal display (LCD)
- 12 units of measurement
- Mono-metal tuning fork sensor (MMTF) provides quick response and stability
- 20-step bar graph display
- Semi-automatic calibration, external weight
- Plastic housing on models <1000 g
- Plastic top and die cast bottom on models >1000 g

Specifications

Weighing Units:

Carat, Pennyweight, Troy Ounce, Decimal Ounce, Decimal Pound (See technical manual for complete listing)

Operating Modes:

Weight, Count, Percentage, Limit Function (Checkweighing)

Power:

115 VAC adapter included (230 VAC optional)

Operating Temperature :

41 °F to 95 °F (5 °C to 35 °C)

Calibration Weight:

TC-620: 600 g
TC-1200: 1,200 g
TC-4200: 4,000 g
TC-6200: 6,200 g

Est. Weight:

TC-620: 2.9 lb (1.3 kg)
TC-1200: 2.9 lb (1.3 kg)
TC-4200: 5.9 lb (2.7 kg)
TC-6200: 5.9 lb (2.7 kg)

Warranty:

Five-year limited

Return Policy:

Rice Lake Standard Policy

Model	Capacity	Readability	Repeatability	Linearity	Pan Size	Dimensions	Part #	List Price
TC-620	620 g	0.01 g	1 division	1 division	Ø 5.5 in (139.7 mm)	9.2 × 7.1 × 2.9 in (234 × 180 × 74 mm)	107232	\$737.00
TC-1200	1,200 g	0.1 g	1 division	1 division	6.7 × 5.6 in (170.2 × 142.2 mm)	10.4 × 7.5 × 3.4 in (264 × 191 × 86 mm)	107233	\$675.00
TC-4200	4,200 g	0.1 g	1 division	1 division	7 × 6.2 in (177.8 × 157.5 mm)	10.4 × 7.5 × 3.4 in (264 × 191 × 86 mm)	107234	\$737.00
TC-6200	6,200 g	0.1 g	1 division	1 division	7 × 6.2 in (177.8 × 157.5 mm)	10.4 × 7.5 × 3.4 in (264 × 191 × 86 mm)	107235	\$795.00

Options/Accessories

Part#	Description	Price
107236	Rechargeable battery TC-620, TC-1200, 32 hr	\$105.00
107237	Rechargeable battery TC-4200, TC-6200, 32 hr	\$105.00
107238	RS-232 option with DIN-5-Pin connector (not compatible with battery option) (TC-620, TC-1200)	\$130.00
107239	RS-232 option with DIN-5-Pin connection (not compatible with battery option) (TC-4200,TC-6200)	\$130.00
107240	In-use dust cover, 620 g to 1,200 g	\$27.00
107250	In-use dust cover, 4,200 g to 6,200 g	\$27.00
109236	Underweigh hook TC-620, TC-1200	\$27.00
109292	Underweigh hook TC-4200, TC-6200	\$27.00
42566	120 VAC adapter/12 VDC	\$68.00
42168	230 VAC adapter	\$74.00
107243	Additional operating manual	\$16.00
75351	WinWedge® software	\$345.00
115303	5-pin DIN to DB9F RS-232 cable	\$98.00
115148	RS-232 manual	\$6.00



Standard Features

- LCD display
- Quick response
- Accumulation, counting and percentage modes
- 13 different units of measure
- Detachable enclosed weighing chamber (in capacities =1 kg)
- Battery operation for up to 40 hours of continuous use (without backlight)
- RS-232 interface for connecting to printer or PC
- Plastic enclosure

Specifications

Weighing Units

Gram, Ounce, Pound, Carat, Pennweight, Troy Ounce, Grain (See technical manual for complete listing)

Operating Modes

Weighing, Percent Weighing, Parts Counting, Accumulation

Power

AC adapter (12 V/500 mA); internal rechargeable battery (6 V/1.2 Ah)

Stabilization Time

2 seconds

Operating Temperature

32° F to 104° F (0° C to 40° C)

Calibration Weight

EQ-300: 300 g, EQ-600: 600 g, EQ-1500: 1,500 g
EQ-3000: 3,000 g, EQ-6000: 6,000 g

Est. Weight

6.6 lb (3 kg)

Warranty

One-year limited warranty

Return Policy

Rice Lake Standard Policy

Battery Life

Up to 40 hours of continuous use (without backlight)

Approval

CE Marked



Model	Capacity	Readability	Repeatability	Linearity	Weighing Chamber	Pan Size	Part #	List Price
EQ-300	300 g	0.01g	0.01g	0.02 g	6.7 × 5.7 × 3.1in (170 × 145 × 80 mm)	Ø 4.7 in (Ø 120 mm)	165338	\$305.00
EQ-600	600 g	0.02 g	0.02 g	0.04 g	6.7 × 5.7 × 3.1in (170 × 145 × 80 mm)	Ø 4.7 in (Ø 120 mm)	165339	\$305.00
EQ-1500	1,500 g	0.05 g	0.05 g	0.1g	N/A	4.8 × 5.6 in (122 × 142 mm)	165340	\$305.00
EQ-3000	3,000 g	0.1g	0.1g	0.2 g	N/A	4.8 × 5.6 in (122 × 142 mm)	165341	\$305.00
EQ-6000	6,000 g	0.2 g	0.2 g	0.4 g	N/A	4.8 × 5.6 in (122 × 142 mm)	165342	\$305.00

Options/Accessories

Part#	Description	Price
41279	Printer cable, DB9M to 25-Pin M	\$70.00
103142	SP742 dot matrix printer, tear bar	\$520.00
119919	AbleCable RS-232/USB cable (requires 130789)	\$190.00
130789	Slim line null modem adapter	\$13.00
131135	Aluminum case	\$103.00
165183	AC adapter, 110-240 VAC, interchangeable plugs	\$46.00



PN 165183 Multi-range AC adapter and multi-plug



MASS COMPARATOR

MC Series

Standard Features

- Super hybrid sensor technology
- Bright VFD display
- Manage ASTM and OIML weights
- Underhook weighing
- Built-in calibration weight
- GLP/LIM/ISO compliant
- RS-232 interface for connecting to printer or PC

Specifications

Weighing Units

Gram, Ounce, Pound, Carat, Pennyweight, Troy Ounce, Pound/Ounce (See technical manual for complete listing)

Operating Modes

Weighing, Percentage, Comparator

Power

120/240 AC adapter

Stabilization Time

5 seconds

Sensitivity Drift (10° C to 30° C)

MC-1000S, MC-6100, MC-10K - ±2 ppm/° C
MC-30K - ±3 ppm/0° C

Operating Temperature

41° F to 104° F (5° C to 40° C) 85% RH or less (no condensation)

Calibration Weight

MC-1000S: 1,000 g
MC-6100: 6,000 g
MC-10K: 10 kg
MC-30K: 30 kg

Est. Weight

MC-1000S - 4.6 kg
MC-6100 - 5.1 kg
MC-10K and MC-30K - 9.3 kg

Warranty

Five-year limited warranty

Return Policy

A&D Weighing Standard Policy - restock fee may apply

Model	Capacity	Readability	Repeatability	Linearity	Pan Size	Dimensions	Part #	List Price
MC-1000S	1,100 g	0.1 mg	0.0005 g / 1 kg / 0.0004 g / 500 g	±0.002 g	5.04 × 5.04in 128 × 128 mm	8.27 × 12.48 × 3.39in 210 × 317 × 86 mm	151262	\$6,470.00
MC-6100	6,100 g	0.001 g	0.004 g / 5 kg / 0.0015 g / 2 kg	±0.02 g	5.79 × 5.79in 147 × 147 mm	10.63 × 8.27in 270 × 210 mm	151263	\$6,475.00
MC-10K	10.1 kg	0.001 g	0.005 g / 10 kg / 0.004 g / 5 kg	±0.03 g	10.63 × 8.27in 270 × 210 mm	11.81 × 13.80 × 4.37in 300 × 355 × 111 mm	151264	\$7,750.00
MC-30K	31 kg	0.01 g	0.015 g / 20 kg	±0.2 g	10.63 × 8.27in 270 × 210 mm	10.63 × 10.63in 270 × 210 mm	151265	\$7,750.00

Options/Accessories

Part#	Model #	Description	Price
151266	AX-MC1000PAN	Auto center pan, MC-1000S	\$1,205.00
151267	AX-MC6100PAN	Auto center pan, MC-6100	\$1,205.00
151268	AX-MC10K-30KPAN	Auto center pan, MC-10/30K	\$1,540.00
151247	AD-1688	Data logger	\$320.00
97649	TB:648	AC adapter (120 V/220 V)	\$45.00
97695*	GX-04	Comparator output, factory installed	\$274.00
97696*	GX-06	Analog output, factory installed	\$866.00
97699	GX-12	Animal weigh pan	\$191.00
97700	GX-13	Density determination for MC-1000S	\$660.00
97607	AD-1682	External rechargeable battery pack	\$710.00
97612	SW-128	Foot switch	\$85.00
196128	AD-8127	Impact dot matrix, statistical printer, includes cable	\$890.00

* Only one option may be installed and requires factory installation



Standard Features

- Built-in fanless static eliminator
- Underhook weighing
- Anti-static glass
- Weighing chamber
- Built-in motorized calibration weight
- One touch environmental filters
- GLP/LIM/ISO compliant
- RS-232C and WinCT© software standard
- AD-1688 Weighing Data Logger included

Specifications

Weighing Units

Carat, Pennyweight, Troy Ounce (See technical manual for complete listing)

Operating Modes

Percentage, Counting

Power

120/240 AC Adapter

Stabilization Time

BM-20: 10 seconds (typically)
 BM-22: 8 to 10 seconds
 BM-252: 8 seconds

Sensitivity Drift (10° C to 30° C)

±2 ppm/° C (when automatic self-calibration is not used)

Calibration Weight

BM-20 and BM-22: 20 g
 BM-252: 200 g

Operating Temperature

41° F to 104° F (5° C to 40° C), 85% RH or less (no condensation)

Est. Weight

10 kg (ships by motor freight)

Warranty

Five-year limited warranty

Return Policy

A&D Weighing Standard Policy - restock fee may apply

Model	Capacity	Readability	Repeatability	Linearity	Pan Size	Dimensions	Part #	List Price
BM-20	22 g	0.000001 g	0.0025 mg	±0.010 mg	25 mm (Ø 0.98 in)	259 × 466 × 326 mm (10.2 × 18.3 × 12.8 in)	150762	\$17,025.00
BM-22	22 g / 5.1 g	0.00001 g / 0.000001 g	0.004 mg / 0.01 mg	±0.010 mg / 0.02 mg	25 mm (Ø 0.98 in)	259 × 466 × 326 mm (10.2 × 18.3 × 12.8 in)	150763	\$16,165.00
BM-252	250 g	0.00001 g	0.03 mg	±0.010 mg	90 mm (Ø 3.6 in)	259 × 466 × 326 mm (10.2 × 18.3 × 12.8 in)	150765	\$8,610.00

Options/Accessories

Part#	Model#	Description	Price
150769	BM-08	Balance OPT, Ethernet BM	\$299.00
97606	AD-1653	Density determination kit (BM-252/200/300/500 only)	\$579.00
97609	AD-8922A	Remote controller	\$650.00
97608	AD-8920A	Universal remote display	\$275.00
97612	SW:128	Foot switch	\$85.00
97649	TB:648	AC adapter (120 V/220 V)	\$45.00
196128	AD-8127	Impact dot matrix, statistical printer, includes cable	\$890.00



MICRO / SEMI-MICRO

PHOENIX GH Series

Standard Features

- Simple and easy to operate, adapts to your environment
- GLP/GMP/GCP/ISO compliant which outputs the calibration data and ID number of the balance for calibration confirmation to the AD-8121B printer
- Internal calibration mass; full digital calibration
- System diagnostic to alert operator of abnormal weighing conditions
- Weighing chamber
- Underhook weighing
- RS-232 interface for connecting to printer or PC
- Data memory function
- Time and date function
- WinCT©; communication tools software
- Liquid crystal display (LCD)

Specifications

Weighing Units

Carat, Pennyweight, Troy Ounce, Decimal Ounce
(See technical manual for complete listing)

Operating Modes

Percentage, Counting

Power

120 V AC (AC Adapter) 50 Hz/60 Hz, 11 VA (110, 220, 240 available by special order)

Stabilization Time

Approx. 3.5 sec (0.1 mg)/8 sec (0.01 mg)

Sensitivity Drift (10° C to 30° C)

±2 ppm/° C (when automatic self-calibration is not used)

Calibration Weight

20 g/50 g/100 g/200 g

Operating Temperature

41° F to 104° F (5° C to 40 C) 85% RH or less
(no condensation)

Est. Weight

Approx. 18 lb (8.2 kg)

Warranty

Five-year limited warranty

Return Policy

A&D Weighing Standard Policy -
restock fee may apply

Model	Capacity	Readability	Repeatability	Linearity	Weighing Chamber	Pan Size	Dimensions	Part #	List Price
GH-202	220 g / 51 g	0.0001 / 0.00001 g	±0.2 mg / ±0.03 mg	0.1 mg / 0.02 mg	164 × 149 × 251 mm (6.45 × 4.87 × 9.88 in)	90 mm (Ø 3.6 in)	217 × 442 × 316 mm (8.54 × 17.4 × 12.24 in)	97601	\$5,350.00
GH-252	250 g / 101 g	0.0001 / 0.00001 g	±0.2 mg / ±0.10 mg	0.1 mg / 0.03 mg	164 × 149 × 251 mm (6.45 × 4.87 × 9.88 in)	90 mm (Ø 3.6 in)	217 × 442 × 316 mm (8.54 × 17.4 × 12.24 in)	97602	\$5,895.00

Options/Accessories

Part #	Model #	Description	Price
97604	GH-08	Ethernet option for GH	\$299.00
97605	AD-100-2	Anti-theft device	\$77.00
97606	AD-1653	Density determination kit	\$579.00
97607	AD-1682	Rechargeable battery pack, external	\$710.00
97608	AD-8920A	Universal remote display	\$275.00
97609	AD-8922A	Remote controller	\$650.00
97610	AD-1683	Static eliminator	\$1,275.00
151247	AD-1688	Data logger	\$320.00
97612	SW:128	Foot switch	\$85.00
97649	TB:648	AC adapter (120 V/220 V)	\$45.00



MICRO / SEMI-MICRO
GEMINI GR Series

Standard Features

- GLP/GMP/GCP/ISO compliant software outputs the calibration data and ID number of the balance for calibration confirmation to the AD-8121B printer
- Easy access door system
- Automatic self-calibration
- Data memory function
- Weighing chamber
- Underhook weighing
- Internal calibration
- Liquid Crystal Display (LCD)
- RS-232 interface for connecting to printer or PC
- WinCT© communication tools software

Specifications

Weighing Units

Carat, Pennyweight, Troy Ounce, Decimal Ounce
 (See technical manual for complete listing)

Operating Modes

Percentage, Counting

Power

120 V AC (AC Adapter) 50Hz/60 Hz, 11 VA (110, 220, 240 VAC adapter by special order)

Stabilization Time

Approx. 3.5 sec (0.1 mg)/8 sec (0.01 mg)

Sensitivity Drift (10° C to 30° C)

±2 ppm/° C (when automatic self-calibration is not used)

Calibration Weight

100 g/200 g

Operating Temperature

41° F to 104° F (5° C to 40° C) 85% RH or less
 (no condensation)

Est. Weight

Approx. 13.2 lb (6.0 kg)

Warranty

Five-year limited warranty

Return Policy

A&D Weighing Standard Policy -
 restock fee may apply

Model	Capacity	Readability	Repeatability	Linearity	Weighing Chamber	Pan Size	Dimensions	Part #	List Price
GR-202	210 / 42 g	0.0001 / 0.00001 g	0.0001 / 0.00002 g	±0.0002 / ±0.00003 g	7.01 × 6.5 × 9.17 in (178 × 160 × 233 mm)	85 mm (Ø 3.3 in)	249 × 330 × 327 mm (9.8 × 12.99 × 12.87 in)	97628	\$4,950.00

Options/Accessories

Part #	A&D Model #	Description	Price
97605	AD-100-2	Anti-theft device	\$77.00
97606	AD-1653	Density determination kit	\$579.00
97607	AD-1682	Rechargeable battery pack	\$710.00
97608	AD-8920A	Universal remote display	\$275.00
97609	AD-8922A	Remote controller	\$650.00
97610	AD-1683	Static eliminator	\$1,275.00
97612	SW:128	Foot switch	\$85.00
97649	TB:648	AC adapter (120 V/220 V)	\$45.00
151247	AD-1688	Data logger	\$320.00
196128	AD-8127	Impact dot matrix, statistical printer, includes cable	\$890.00



ANALYTICAL ION BM Series

Standard Features

- Built-in fanless static eliminator
- Underhook weighing
- Anti-static glass
- Weighing chamber
- Built-in motorized calibration weight
- One touch environmental filters
- GLP/LIM/ISO compliant
- RS-232C and WinCT[®] software standard
- AD-1688 Weighing Data Logger included

Specifications

Weighing Units

Carat, Pennyweight, Troy Ounce (See technical manual for complete listing)

Operating Modes

Percentage, Counting

Power

120/240 AC Adapter

Stabilization Time

BM-200, BM-300, BM-500: Approx. 3.5 seconds

Sensitivity Drift (10° C to 30° C)

±2 ppm/° C (when automatic self-calibration is not used)

Calibration Weight

BM-200: 200 g
BM-300: 300 g
BM-500: 500 g

Operating Temperature

41° F to 104° F (5° C to 40° C), 85% RH or less (no condensation)

Est. Weight

10 kg (ships by motor freight)

Warranty

Five-year limited warranty

Return Policy

A&D Weighing Standard Policy - restock fee may apply

Model	Capacity	Readability	Repeatability	Linearity	Pan Size	Dimensions	Part #	List Price
BM-200	220 g	0.0001 g	0.1 mg	±0.2 mg	90 mm (Ø 3.6 in)	259 × 466 × 326 mm (10.2 × 18.3 × 12.8 in)	150766	\$6,750.00
BM-300	320 g	0.0001 g	0.2 mg	±0.3 mg	90 mm (Ø 3.6 in)	259 × 466 × 326 mm (10.2 × 18.3 × 12.8 in)	150767	\$7,105.00
BM-500	520 g	0.0001 g	0.2 mg	±0.5 mg	90 mm (Ø 3.6 in)	259 × 466 × 326 mm (10.2 × 18.3 × 12.8 in)	150768	\$7,500.00

Options/Accessories

Part #	Model #	Description	Price
150769	BM-08	Balance OPT, Ethernet BM	\$299.00
97606	AD-1653	Density determination kit	\$579.00
97609	AD-8922A	Remote controller	\$650.00
97608	AD-8920A	Universal remote display	\$275.00
97612	SW:128	Foot switch	\$85.00
97649	TB:648	AC adapter (120 V/220 V)	\$45.00
196128	AD-8127	Impact dot matrix, statistical printer, includes cable	\$890.00



Standard Features

- Simple and easy to operate, adapts to your environment
- GLP/GMP/GCP/ISO compliant which outputs the calibration data and ID number of the balance for calibration confirmation to the AD-8121B printer
- Internal calibration mass; full digital calibration
- System diagnostic to alert operator of abnormal weighing conditions
- Weighing chamber
- Underhook weighing
- RS-232 interface for connecting to printer or PC
- Data memory function
- Time and date function
- WinCT©; communication tools software
- Liquid crystal display (LCD)

Specifications

Weighing Units

Carat, Pennyweight, Troy Ounce, Decimal Ounce
(See technical manual for complete listing)

Operating Modes

Percentage, Counting

Power

120 V AC (AC Adapter) 50 Hz/60 Hz, 11 VA
(110, 220, 240 available by special order)

Stabilization Time

Approx. 3.5 sec (0.1 mg)/8 sec (0.01 mg)

Sensitivity Drift (10° C to 30° C)

±2 ppm/° C (when automatic self-calibration is not used)

Calibration Weight

GH-120: 50 g/100 g
GH-200: 100 g/200 g
GH-300: 100 g/200 g/300 g

Operating Temperature

41° F to 104° F (5° C to 40 C) 85% RH or less
(no condensation)

Est. Weight

Approx. 18 lb (8.2 kg)

Warranty

Five-year limited warranty

Return Policy

A&D Weighing Standard Policy - restock fee may apply

Model	Capacity	Readability	Repeatability	Linearity	Weighing Chamber	Pan Size	Dimensions	Part #	List Price
GH-120	120 g	0.0001 g	±0.2 mg	0.1 mg	164 × 149 × 251 mm (6.45 × 4.87 × 9.88 in)	90 mm (Ø 3.6 in)	217 × 442 × 316 mm (8.54 × 17.4 × 12.24 in)	97597	\$3,540.00
GH-200	220 g	0.0001 g	±0.2 mg	0.1 mg	164 × 149 × 251 mm (6.45 × 4.87 × 9.88 in)	90 mm (Ø 3.6 in)	217 × 442 × 316 mm (8.54 × 17.4 × 12.24 in)	97599	\$4,010.00
GH-300	320 g	0.0001 g	±0.3 mg	0.2 mg	164 × 149 × 251 mm (6.45 × 4.87 × 9.88 in)	90 mm (Ø 3.6 in)	217 × 442 × 316 mm (8.54 × 17.4 × 12.24 in)	97600	\$4,765.00

Options/Accessories

Part#	Model#	Description	Price
97604	GH-08	Ethernet option for GH	\$299.00
97605	AD-100-2	Anti-theft device	\$77.00
97606	AD-1653	Density determination kit	\$579.00
97607	AD-1682	Rechargeable battery pack, external	\$710.00
97608	AD-8920A	Universal remote display	\$275.00
97609	AD-8922A	Remote controller	\$650.00
97610	AD-1683	Static eliminator	\$1,275.00
151247	AD-1688	Data logger	\$320.00
97612	SW:128	Foot switch	\$85.00
97649	TB:648	AC adapter (120 V/220 V)	\$45.00



ANALYTICAL GEMINI GR Series

Standard Features

- GLP/GMP/GCP/ISO compliant software outputs the calibration data and ID number of the balance for calibration confirmation to the AD-8121B printer
- Easy access door system
- Automatic self-calibration
- Data memory function
- Weighing chamber
- Underhook weighing
- Internal calibration
- Liquid Crystal Display (LCD)
- RS-232 interface for connecting to printer or PC
- WinCT[©] communication tools software

Specifications

Weighing Units

Carat, Pennyweight, Troy Ounce, Decimal Ounce
(See technical manual for complete listing)

Operating Modes

Percentage, Counting

Power

120 V AC (AC Adapter) 50Hz/60 Hz, 11 VA
(110, 220, 240 VAC adapter by special order)

Stabilization Time

Approx. 3.5 sec (0.1 mg)/8 sec (0.01 mg)

Sensitivity Drift (10° C to 30° C)

±2 ppm/° C (when automatic self-calibration is not used)

Calibration Weight

GR-120: 50 g/100 g
GR-200: 100 g/200 g
GR-300: 200 g/300 g

Operating Temperature

41° F to 104° F (5° C to 40° C) 85% RH or less
(no condensation)

Est. Weight

13.2 lb (6.0 kg)

Warranty

Five-year limited warranty

Return Policy

A&D Weighing Standard Policy -
restock fee may apply

Model	Capacity	Readability	Repeatability	Linearity	Weighing Chamber	Pan Size	Dimensions	Part #	List Price
GR-120	120 g	0.0001 g	0.0001 g	±0.0002 g	7.01 × 6.5 × 9.17 in (178 × 160 × 233 mm)	85 mm (Ø 3.3 in)	249 × 330 × 327 mm (9.8 × 12.99 × 12.87 in)	97625	\$3,075.00
GR-200	210 g	0.0001 g	0.0001 g	±0.0002 g	7.01 × 6.5 × 9.17 in (178 × 160 × 233 mm)	85 mm (Ø 3.3 in)	249 × 330 × 327 mm (9.8 × 12.99 × 12.87 in)	97626	\$3,495.00
GR-300	310 g	0.0001 g	0.0001 g	±0.0002 g	7.01 × 6.5 × 9.17 in (178 × 160 × 233 mm)	85 mm (Ø 3.3 in)	249 × 330 × 327 mm (9.8 × 12.99 × 12.87 in)	97627	\$4,350.00

Options/Accessories

Part #	A&D Model #	Description	Price
97605	AD-100-2	Anti-theft device	\$77.00
97606	AD-1653	Density determination kit	\$579.00
97607	AD-1682	Rechargeable battery pack	\$710.00
97608	AD-8920A	Universal remote display	\$275.00
97609	AD-8922A	Remote controller	\$650.00
97610	AD-1683	Static eliminator	\$1,275.00
97612	SW:128	Foot switch	\$85.00
97649	TB:648	AC adapter (120 V/220 V)	\$45.00
151247	AD-1688	Data logger	\$320.00
196128	AD-8127	Impact dot matrix, statistical printer, includes cable	\$890.00



Standard Features

- Fast stabilization time
- One-touch calibration in HR-AZ models
- Compact size
- Weighing chamber
- Rotary sliding doors
- Removable breeze break with anti-static coating
- GLP/GMP/GCP/ISO compliant

Specifications

Weighing Units

Carat, Pennyweight, Troy Ounce, Decimal Ounce
(See technical manual for complete listing)

Operating Modes

Weighing, Percent Weighing, Parts Counting, Density

Power

120/240 AC adapter

Stabilization Time

3 seconds

Operating Temperature

41° F to 104° F (5° C to 40° C), 85% RH or less
(no condensation)

Calibration Weight

HR-100A and HR100AZ: 200g
HR-150A and HR-150AZ: 150g
HR-250A and HR-250AZ: 100g

Est. Weight

8.6 lb (3.9 kg)

Warranty

Five-year limited warranty

Return Policy

A&D Weighing Standard Policy -
restock fee may apply

Model	Capacity	Readability	Repeatability	Linearity	Pan Size	Dimensions	Part #	List Price
HR-100A	102 g	0.0001 g	0.1 mg	± 0.2 mg	90 mm (Ø 3.6 inches)	198 × 294 × 313 mm (7.8 × 11.6 × 12.3 in)	150777	\$1,835.00
HR-100AZ	102 g	0.0001 g	0.1 mg	± 0.2 mg	90 mm (Ø 3.6 inches)	198 × 294 × 313 mm (7.8 × 11.6 × 12.3 in)	150779	\$2,295.00
HR-150A	152 g	0.0001 g	0.1 mg	± 0.2 mg	90 mm (Ø 3.6 inches)	198 × 294 × 313 mm (7.8 × 11.6 × 12.3 in)	150780	\$1,960.00
HR-150AZ	152 g	0.0001 g	0.1 mg	± 0.2 mg	90 mm (Ø 3.6 inches)	198 × 294 × 313 mm (7.8 × 11.6 × 12.3 in)	150781	\$2,410.00
HR-250A	252 g	0.0001 g	<200 mg 0.1 mg / >200 mg 0.2 mg	± 0.3 mg	90 mm (Ø 3.6 inches)	198 × 294 × 313 mm (7.8 × 11.6 × 12.3 in)	150782	\$2,130.00
HR-250AZ	252 g	0.0001 g	<200 mg 0.1 mg / >200 mg 0.2 mg	± 0.3 mg	90 mm (Ø 3.6 inches)	198 × 294 × 313 mm (7.8 × 11.6 × 12.3 in)	150783	\$2,555.00

Options/Accessories

Part #	A&D Model #	Description	Price
151247	AD-1688	Data logger	\$320.00
98027*	FXi-02	Quick USB interface with cable	\$91.00
98028*	FXi-08	Ethernet interface with WIN-CT Plus	\$299.00
98029*	FXi-09	Rechargeable battery	\$335.00
97649	TB:648	AC adapter (120 V/220 V)	\$45.00

*Only one option may be installed and factory installation required



ANALYTICAL ORION HR Series

Standard Features

- GLP/GMP/GCP/ISO compliant software outputs the calibration data and ID number of the balance for calibration confirmation to the AD-8121B printer
 - System diagnostics to alert the operator of abnormal weighing conditions
 - RS-232C bidirectional interface (option for HR-60, HR-120 and HR-200; standard for HR-300i and HR-202i)
 - Weighing chamber
 - Underhook capability for density measurement and weighing magnetic materials
 - Liquid Crystal Display (LCD)
 - WinCT[®] communication tools software
- Note: Orion HR series does have internal calibration*

Specifications

Weighing Units

Carat, Pennyweight, Troy Ounce, Decimal Ounce
(See technical manual for complete listing)

Operating Modes

Percentage, Counting

Power

120 V AC (AC adapter) 50 Hz/60 Hz (110, 220, 240 V
AC adapter available by special order)

Stabilization Time

Approx. 3.5 seconds

Sensitivity Drift (10° C to 30° C)

±2 ppm/° C (when automatic self-calibration
is not used)

Calibration Weight

300 g/200 g/100 g

Operating Temperature

41° F to 104° F (5° C to 40° C) 85% RH or less
(no condensation)

Est. Weight

Approx. 17.6 lb (8.0 kg)

Warranty

Five-year limited warranty

Return Policy

A&D Weighing Standard Policy -
restock fee may apply

Model	Capacity	Readability	Repeatability	Linearity	Weighing Chamber	Pan Size	Dimensions	Part #	List Price
HR-300i	320 g	0.0001 g	±0.0003 mg	0.0002 mg	164 × 149 × 251 mm (6.45 × 5.84 × 9.88 in)	90 mm (Ø 3.6 in)	8.54 × 17.4 × 12.24 in (217 × 442 × 316 mm)	97642	\$4,185.00

Options/Accessories

Part#	A&D Model #	Description	Price
97605	AD-100-2	Anti-theft device	\$77.00
97606	AD-1653	Density determination kit	\$579.00
97607	AD-1682	Rechargeable battery pack	\$710.00
97608	AD-8920A	Universal remote display	\$275.00
97610	AD-1683	Static eliminator	\$1,275.00
97609	AD-8922A	Remote controller	\$650.00
97649	TB:648	AC adapter (120 V/220 V)	\$45.00
151247	AD-1688	Data logger	\$320.00
196128	AD-8127	Impact dot matrix, statistical printer, includes cable	\$890.00



ANALYTICAL AD-4212A Series

Standard Features

- Comparator output (Hi/OK/Lo) feature for manual or automatic operation as well as buzzer function
- GLP/GMP compliant software output
- Breeze break for maximum accuracy and fastest response
- Standard calibration weight
- Simple operator reference card provided
- Multi-weighing units
- Time and date clock function
- Data memory function for weighing, calibration, counting and Hi/OK/Lo values
- Super Hybrid Sensor Technology (SHS)
- WinCT[®] communication tools software
- RS-232 interface for connecting to printer or PC

Specifications

Weighing Units

Milligram, Ounce, Carat, Pennyweight, Troy Ounce, Grain (See technical manual for complete listings)

Operating Modes

Counting, Percentage

Power Supply

120 V AC Adapter, 11 VA

Stabilization Time (typical)

AD-4212A-100, AD-4212B-102:
0-30 g approx. 1.3 seconds
30 g-110 g approx. 1.3 seconds

I/O Interface Comparator Output

3 level output with buzzer

I/O Interface External Contact Input

Re-zero and print

Calibration Weight

AD-4212A-100, AD-4212B-102: 50 g

Connection Cable

Approx. 2 m (between weighing unit and display unit)

Operating Temperature

41° F to 104° F (5° C to 40° C) 85% RH or less (no condensation)

Est. Weight

8.5 lb (4 kg)

Warranty

Five-year limited warranty

Return Policy

A&D Weighing Standard Policy - restock fee may apply

Model	Capacity	Readability	Repeatability	Linearity	Pan Size	Dimensions	Part #	List Price
AD-4212A-100	110 g	0.1 mg	0.15 g	±0.3 mg	2 × 2 in (50 × 50 mm)	3.2 × 9.1 × 3.5 in (80 × 230 × 90 mm)	97654	\$5,660.00
AD-4212B-102	110 g	0.01 mg	0.15 g	±0.3 mg	2 × 2 in (50 × 50 mm)	3.2 × 9.1 × 3.5 in (80 × 230 × 90 mm)	102925	\$8,750.00
AD-4212B-201	210 g	0.1 mg	1 mg	±2 mg	2 × 2 in (50 × 50 mm)	3.2 × 9.1 × 3.5 in (80 × 230 × 90 mm)	102926	\$6,695.00
AD-4212B-301	310 g	0.1 mg	1 mg	±2 mg	2 × 2 in (50 × 50 mm)	3.2 × 9.1 × 3.5 in (80 × 230 × 90 mm)	102927	\$7,450.00

Options/Accessories

Part #	A&D Model #	Description	Price
97672	AD-4212A-01	BCD output (factory installed, four month lead time)	\$581.00
97674	AD-4212A-07	Extension cable, 3 m	\$171.00
97675	AD-4212A-08	Ethernet Interface with WinCT [®]	\$299.00
97676	AD-4212A-19	Stainless steel breeze break (200 g only)	\$110.00



ANALYTICAL APOLLO GF Series

Standard Features

- Electronically controlled load (ECL) self-diagnostic before internal repeatability test without an external weight in less than 1.5 minutes
- External calibration
- Impact shock detection
- Flow rate display
- RS-232 interface for connecting to printer or PC
- Password protection and anti-theft security slot
- GLP/GMP/ISO compliant to either AD-8127 printer or computer
- Transmits date, time, ID number, serial number, model, manufacturer and calibration data
- Rechargeable battery option for portability
- Super Hybrid Sensor Technology (SHS)
- Reverse backlit LCD display
- Optional glass breeze break
- Underhook weighing

Specifications

Weighing Units

Gram, Ounce, Pound, Pound/Ounce, Troy Ounce, Grain (See technical manual for complete listing)

Operating Modes

Weigh, Count and Percent

Power

110/220V VAC adapter

Stabilization Time

Approx. 1 second (typical in FAST mode)

Calibration Weight

GF-124A: 100 g
GF-224A: 200 g
GF-324A: 300 g

Operating Temperature

41° F to 104° F (5° C to 40° C)

Est. Weight

11 lb (5.2 kg)

Warranty

Five-year limited warranty

Return Policy

A&D Weighing Standard Policy - restock fee may apply

Model	Capacity	Readability	Repeatability	Linearity	Weighing Chamber	Pan Size	Dimensions	Part #	List Price
GF-124A	120 g	0.0001 g	0.0001 g	±0.0002 g	8.78 in H (223 mm H)	Ø90 mm	259 × 358 × 332 mm (10.2 × 14.1 × 13.1 in) <i>Includes Large Glass Breeze Break</i>	200327	\$2,475.00
GF-224A	220 g	0.0001 g	0.0001 g	±0.0002 g	8.78 in H (223 mm H)	Ø90 mm	259 × 358 × 332 mm (10.2 × 14.1 × 13.1 in) <i>Includes Large Glass Breeze Break</i>	200328	\$2,700.00
GF-324A	320 g	0.0001 g	0.0002 g (300 g) 0.0001 g (200 g)	±0.0003 g	8.78 in H (223 mm H)	Ø90 mm	259 × 358 × 332 mm (10.2 × 14.1 × 13.1 in) <i>Includes Large Glass Breeze Break</i>	200329	\$3,200.00

Options/Accessories

Part #	A&D Model #	Description	Price
192662	GXA-03	RS-232C Interface (D-sub 9P male)	\$235.00
192663	GXA-04	Comparator output (requires 192667)	\$225.00
192667	AX-K05692	MiniDIN 8 pin male for GXA-04	\$45.00
192671	GXA-06	Analog output (includes 192673)	\$225.00
192674	GXA-09	Internal rechargeable battery (must be factory installed)	\$470.00
192675	GXA-10	Large glass breeze break	\$330.00
192676	GXA-12	Animal weighing pan (for models of 320 g capacity or higher)	\$145.00
192677	GXA-13	Density determination kit (for 1 mg models only)	\$515.00
192678	GXA-17	Large breeze break with built-in fanless ionizer (static eliminator)	\$925.00
192679	GXA-23-PRINT	External key input interface for SW:137-PRINT foot switch	\$215.00
192680	GXA-23-RZERO	External key input interface for SW:137-REZERo foot switch	\$210.00
192681	GXA-23-PLUG	External key input interface for AX-T-314A-S plug	\$210.00
192682	GXA-24	USB host interface (USB A type)	\$110.00
192683	GXA-25	External fanless ionizer (static eliminator)	\$830.00
192684	GXA-26	External IR switch (MiniDIN 4 pin male)	\$175.00



Apollo GF-324A

Standard Features

- Electronically controlled load (ECL) self-diagnostic before internal repeatability test without an external weight in less than 1.5 minutes
- Internal calibration weight
- Impact shock detection
- Flow rate display
- RS-232 interface for connecting to printer or PC
- Password protection and anti-theft security slot
- GLP/GMP/ISO compliant to either AD-8127 printer or computer
- Transmits date, time, ID number, serial number, model, manufacturer and calibration data
- Rechargeable battery option for portability
- Super Hybrid Sensor Technology (SHS)
- Reverse backlit LCD display
- Optional glass breeze break
- Underhook weighing

Specifications

Weighing Units

Gram, Ounce, Pound, Carat, Pennyweight, Troy Ounce, Grain (See technical manual for complete listing)

Operating Modes

Animal Weighing, Comparator Function, ACAI Counting Function, Percentage, Density Determination, Statistical Calculation

Power

120 VAC adapter, Approx. 30 VA

Stabilization Time

GX-124A: Approx. 1.5 seconds
 GX-124AE: Approx. 2 seconds
 GX-224A, GX-224AE: Approx. 1 second
 GX-324A, GX-324AE: Approx. 2 seconds

Display Refresh Rate

5 times/second, 10 times/second, 20 times/second

Calibration Weight

GX-124A, GX-124AE: 100g
 GX-224A, GX-224AE, GX-324A, GX-324AE: 200g

Ionizer (fanless)

AE versions come standard with built-in fanless ionizer with external touchless sensor

Operating Temperature

41° F to 104° F (5° C to 40° C) RH less than 85% (no condensation)

Est. Weight

18 lb (8 kg)

Warranty

Five-year limited warranty

Return Policy

A&D Weighing Standard Policy - restock fee may apply

Model	Capacity	Readability	Repeatability	Linearity	Weighing Chamber	Pan Size	Dimensions	Part #	List Price
GX-124A	120 g	0.0001 g	0.0001 g	±0.0002 g	8.78 in H (223 mm H)	Ø90 mm	10.2 × 14.1 × 13.1 in (259 × 358 × 332 mm) <i>Includes Large Glass Breeze Break</i>	200330	\$2,950.00
GX-124AE	120 g	0.0001 g	0.0001 g	±0.0002 g	8.78 in H (223 mm H)	Ø90 mm	259 × 358 × 332 mm (10.2 × 14.1 × 13.1 in) <i>Includes Large Glass Breeze Break</i>	200334	\$4,395.00
GX-224A	220 g	0.0001 g	0.0001 g	±0.0002 g	8.78 in H (223 mm H)	Ø90 mm	259 × 358 × 332 mm (10.2 × 14.1 × 13.1 in) <i>Includes Large Glass Breeze Break</i>	200332	\$3,175.00
GX-224AE	220 g	0.0001 g	0.0001 g	±0.0002 g	8.78 in H (223 mm H)	Ø90 mm	259 × 358 × 332 mm (10.2 × 14.1 × 13.1 in) <i>Includes Large Glass Breeze Break</i>	200335	\$4,585.00
GX-324A	320 g	0.0001 g	0.0002 g (300 g) 0.0001 g (200 g)	±0.0003 g	8.78 in H (223 mm H)	Ø90 mm	259 × 358 × 332 mm (10.2 × 14.1 × 13.1 in) <i>Includes Large Glass Breeze Break</i>	200333	\$3,550.00
GX-324AE	320 g	0.0001 g	0.0002 g (300 g) 0.0001 g (200 g)	±0.0003 g	8.78 in H (223 mm H)	Ø90 mm	259 × 358 × 332 mm (10.2 × 14.1 × 13.1 in) <i>Includes Large Glass Breeze Break</i>	200336	\$4,925.00

Options/Accessories

Part #	A&D Model #	Description	Price
192662	GXA-03	RS-232C Interface (D-sub 9P male)	\$235.00
192663	GXA-04	Comparator output (requires 192667)	\$225.00
192667	AX-K05692	MiniDIN 8 pin male for GXA-04	\$45.00
192671	GXA-06	Analog output (includes 192673)	\$225.00
192674	GXA-09	Internal rechargeable battery (must be factory installed)	\$470.00
192675	GXA-10	Large glass breeze break	\$330.00
192676	GXA-12	Animal weighing pan (for models of 320 g capacity or higher)	\$145.00
192677	GXA-13	Density determination kit (for 1 mg models only)	\$515.00
192679	GXA-23-PRINT	External key input interface for SW:137-PRINT foot switch	\$215.00
192680	GXA-23-RZERO	External key input interface for SW:137-REZERo foot switch	\$210.00
192681	GXA-23-PLUG	External key input interface for AX-T-314A-S plug	\$210.00
192682	GXA-24	USB host interface (USB A type)	\$110.00
192683	GXA-25	External fanless ionizer (static eliminator)	\$830.00
192684	GXA-26	External IR switch (MiniDIN 4 pin male)	\$175.00



LEGAL FOR TRADE

GF-P Series

Standard Features

- Pill-counting feature also complies with Handbook 44 requirements
- Fast, Super Hybrid Sensor (SHS) gives you the ultimate in response speed; just one second
- GLP/GMP/ISO compliance
- WinCT[®] communication tools software included
- Weighing chamber
- Tough die-cast aluminum housing
- Removable stainless steel pan 5 in x 5 in (127 mm x 127 mm)
- NTEP Certified and Pharmacopoeia approved
- IP54 splash proof operator keyboard protects against dust and spills, stainless steel weigh pan
- Data memory function
- Vacuum Fluorescent Display (VFD)
- RS-232 interface for connecting to printer or PC

Specifications

Weighing Units

Gram, Ounce, Pound, Pound/Ounce, Troy Ounce, Grain, Pound/Ounce (See technical manual for complete listing)

Operating Modes

Weigh, Count and Percent

Power

110/220V VAC adapter

Stabilization Time

Approx. 1 second (typical in FAST mode)

Decimal Ounce

GF-200P: 7.40755 × 0.00005 oz
GF-300P: 10.93493 × 0.00005 oz

Calibration Weight

GF-200P, GF-300P: 200 g

Operating Temperature

41° F to 104° F (5° C to 40° C)

Est. Weight

11 lb (5.2 kg)

Warranty

Five-year limited warranty

Return Policy

A&D Weighing Standard Policy - restock fee may apply

Approvals

NTEP CC 04-077 e=0.01g



Model	Capacity	Readability	Repeatability	Linearity	Weighing Chamber	Pan Size	Dimensions	Part #	List Price
GF-200P	210 g	0.001 g	0.001 g	±0.002 g	92 mm (3.6 in H)	127 mm (5 × 5 in)	210 × 317 × 86 mm (8.27 × 12.48 × 3.39 in)	97799	\$1,385.00
GF-300P	310 g	0.001 g	0.001 g	±0.002 g	92 mm (3.6 in H)	127 mm (5 × 5 in)	210 × 317 × 86 mm (8.27 × 12.48 × 3.39 in)	97800	\$1,650.00

Options/Accessories

Part#	A&D Model #	Description	Price
102891	GX-02	USB option	\$155.00
97697	GX-10	Glass breeze break for GF-200 and 300	\$284.00
97703	AX:073003691-S	Protective in-use cover for GF-200/300 (each)	\$21.00
97649	TB:648	AC adapter (120 V/220 V) standard with unit	\$45.00



Standard Features

- Compact Super Hybrid Sensor Technology (SHS)
- Vacuum Fluorescent Display (VFD)
- GLP/GMP/ISO compliant to either AD-8121 printer or computer. Transmits date, time, ID number, serial number and calibration data
- RS-232 interface for connecting to printer or PC
- Response indicator function
- Weighing chamber
- Underhook weighing

OPTIONS

- Built-in rechargeable battery
- Quick USB interface (FXi-02) option
- LAN-Ethernet interface
- WinCT[®] communication tools software

Specifications

Weighing Units

Pound, Carat, Pennyweight, Troy Ounce, Grain, Pound/Ounce (See technical manual for complete listings)

Operating Modes

Weigh, Count, Percent, Animal Weighing, Statistical, Hold and Comparator

Power Consumption

120/240 V AC adapter, approx. 11 VA

Stabilization Time

Approx. 1 second

Sensitivity Drift (10° C to 30° C)

±2 ppm/° C (when automatic self-calibration is not used)

Display Refresh Rate

5 times/second, 10 times/second or 20 times/second

Operating Temperature

41° F to 104° F (5° C to 40° C) 85% RH or less (no condensation)

Calibration Weight

FX-300i: 300 g
FX-1200i: 1,000 g

Est. Weight

8 lb (3.5 kg)

Warranty

Five-year limited warranty

Return Policy

A&D Weighing Standard Policy - restock fee may apply

Approvals

NTEP CC 08-045
Measurement Canada AM-5692



Model	Capacity	Readability	Repeatability	Linearity	Pan Size	Dimensions	Part #	List Price
NTEP Certified								
FX-1200iN	1,220 g	0.01 g	0.01 g	±0.02 g	5.90 in (150 mm)	7.6 × 10.3 × 3.3 in (193 × 262.5 × 84.5 mm)	163641	\$1,175.00
Measurement Canada Approved								
FX-300iNC	320 g	0.001 g	0.001 g	±0.002 g	130 mm (5.12 in)	7.6 × 10.3 × 3.3 in (193 × 263 × 84.5 mm)	168077	\$1,245.00
FX-1200iNC	1,220 g	0.01 g	0.01 g	±0.02 g	5.90 in (150 mm)	7.6 × 10.3 × 3.3 in (193 × 262.5 × 84.5 mm)	168076	\$1,185.00

Options/Accessories

Part #	A&D Model #	Description	Price
98027*	FXi-02	Quick USB interface	\$91.00
98028*	FXi-08	Ethernet interface with WinCT [®] Plus software	\$299.00
98029*	FXi-09	Built-in rechargeable battery	\$335.00
98030	FXi-10	Small breeze break	\$81.00
98031	FXi-11	Large breeze break	\$135.00
97649	TB:648	AC adapter (120 V/220 V)	\$45.00
151247	AD-1688	Data logger	\$320.00
196128	AD-8127	Impact dot matrix, statistical printer, includes cable	\$890.00

*Options FXi-02/FXi-08 and FXi-09 cannot be combined and are factory installed only.



LEGAL FOR TRADE
EK-i Series

Standard Features

- Backlit weight display
- Remote zeroing
- Easy to install NiCad battery option
- RS-232 interface for connecting to printer or PC

Specifications

Weighing Units

Carat, Pennyweight, Troy Ounce, Newton, Decimal Ounce, Decimal Pound

Operating Modes

Counting, Percentage

Power

120 VAC adapter (Optional Ni-MH battery pack)

Stabilization Time

< 2 seconds

Sensitivity Drift (10° C to 30° C)

±20 ppm/° C (when automatic self-calibration is not used)

Display Type

7 segment LCD with backlight
(character height 16 mm)

Operating Temperature

14° F to 104° F (-10° C to 40° C) less than 85% R.H.
(non-condensing)

Calibration Weight

EK-600i: 400 g
EK-1200i: 1,200 g
EK-6000i: 6,000 g
EK-12i: 12 kg

Est. Weight

3.5 lb (1.5 kg)

Warranty

Five-year limited warranty

Return Policy

A&D Weighing Standard Policy - restock fee may apply

Approvals

NTEP CC-04-019



Model	Capacity	Readability	Repeatability	Linearity	Pan Size	Dimensions	Part #	List Price
NTEP Certified								
EK-600i	600 g	0.1 g	0.1 g	±0.1 g	133 × 170 mm (5.2 × 6.7 in)	190 × 218 × 55 mm (7.5 × 8.6 × 2.2 in)	97752	\$545.00
EK-1200i	1,200 g	0.1 g	0.1 g	±0.1 g	133 × 170 mm (5.2 × 6.7 in)	190 × 218 × 55 mm (7.5 × 8.6 × 2.2 in)	97753	\$540.00
EK-6000i	6,000 g	1 g	1 g	±1 g	133 × 170 mm (5.2 × 6.7 in)	190 × 218 × 55 mm (7.5 × 8.6 × 2.2 in)	97758	\$580.00
EK-12i	12,000 g	1 g	1 g	±1 g	133 × 170 mm (5.2 × 6.7 in)	190 × 218 × 55 mm (7.5 × 8.6 × 2.2 in)	97759	\$735.00

Options/Accessories

Part #	A&D Model #	Description	Price
97760	EKW-04i	Comparator/relay outputs/buzzer	\$170.00
97761	EKW-07i	Underhook for EK-4100i/6100i/6000i/12Ki/EW-12Ki	\$55.00
97762	EKW-09i	NiCad battery pack	\$220.00
97764	AX:3005824-5S	Protective dust cover (not in use)	\$15.00
97605	AD-100-2	Anti-theft device	\$77.00
97766	TB:662	AC adapter (120 V)	\$44.00
97767	TB:164	AC adapter (240 V)	\$55.00
151247	AD-1688	Data logger	\$320.00



Standard Features

- Backlit weight display
- Remote zeroing
- Easy-to-install NiCad battery option
- RS-232 interface for connecting to printer or PC
- Triple range

Specifications

Weighing Units

Carat, Pennyweight, Troy Ounce, Decimal Ounce, Decimal Pound

Operating Mode

Counting, Percentage, Comparator

Power

AC adapter or Ni-MH battery pack (option)

Stabilization Time

< 2 seconds

Sensitivity Drift (10° C to 30° C)

±20 ppm/° C (when automatic self-calibration is not used)

Operating Temperature

14° F to 104° F (-10° C to 40° C) less than 85% R.H. (non-condensing)

Calibration Weight

EW-1500i: 1,500 g
EW-12Ki: 12 kg

Est. Weight

3.5 lb (1.5 kg)

Warranty

Five-year limited warranty

Return Policy

A&D Weighing Standard Policy - restock fee may apply

Approvals

NTEP CC 04-019



Model	Capacity	Readability	Repeatability	Linearity	Pan Size	Dimensions	Part #	List Price
NTEP Certified								
EW-1500i	300 g / 600 g / 1,500 g	0.1 g / 0.2 g / 0.5 g	0.1 g / 0.2 g / 0.5 g	±0.1 g / ±0.2 g / ±0.5 g	133 × 170 mm (5.2 × 6.7 in)	190 × 218 × 55 mm (7.5 × 8.6 × 2.2 in)	97769	\$435.00
EW-12Ki	3,000 g / 6,000 g / 12,000 g	1 g / 2 g / 5 g	1 g / 2 g / 5 g	±1 g / ±2 g / ±5 g	133 × 170 mm (5.2 × 6.7 in)	190 × 218 × 55 mm (7.5 × 8.6 × 2.2 in)	97771	\$435.00

Options/Accessories

Part #	A&D Model #	Description	Price
97760	EKW-04i	Comparator/relay outputs/buzzer	\$170.00
97761	EKW-07i	Underhook for EK-4100i/6100i/6000i/12Ki/EW-12Ki	\$55.00
97762	EKW-09i	NiCad battery pack	\$220.00
97764	AX:3005824-5S	Protective dust cover (not in use)	\$15.00
97605	AD-100-2	Anti-theft device	\$77.00
97766	TB:662	AC adapter (120 V)	\$44.00
97767	TB:164	AC adapter (240 V)	\$55.00
151247	AD-1688	Data logger	\$320.00



EW-1500i square pan

PRECISION

APOLLO GX Series

Standard Features

- Electronically controlled load (ECL) self-diagnostic before internal repeatability test without an external weight in less than 1.5 minutes
- Internal calibration weight
- Impact shock detection
- Flow rate display
- RS-232 interface for connecting to printer or PC
- Password protection and anti-theft security slot
- GLP/GMP/ISO compliant to either AD-8127 printer or computer
- Transmits date, time, ID number, serial number, model, manufacturer and calibration data
- Rechargeable battery option for portability
- Super Hybrid Sensor Technology (SHS)
- Reverse backlit LCD display
- Optional glass breeze break
- Underhook weighing

Specifications

Weighing Units

Gram, Ounce, Pound, Carat, Pennyweight, Troy Ounce, Grain (See technical manual for complete listing)

Operating Modes

Animal Weighing, Comparator Function, ACAI Counting Function, Percentage, Density Determination, Statistical Calculation

Power

120 VAC adapter, Approx. 30 VA

Stabilization Time

Approx. 1 second

Display Refresh Rate

5 times/second, 10 times/second or 20 times/second

Ionizer (fanless)

AE versions come standard with built-in fanless ionizer with external touchless sensor

Calibration Weight

GX-203A, GX-303A: 200g
GX-403A: 400g
GX-603A: 600g
GX-1003A, GX-1603A: 1000g

Est. Weight

18 lb (8 kg)

Operating Temperature

41° F to 104° F (5° C to 40° C) RH less than 85% (no condensation)

Warranty

Five-year limited warranty

Return Policy

A&D Weighing Standard Policy - restock fee may apply

Model	Capacity	Readability	Repeatability	Linearity	Weighing Chamber	Pan Size	Dimensions	Part #	List Price
GX-203A	220 g	0.001 g	0.001 g	±0.002 g	3 in (85 mm)	5 × 5 in (128 × 128 mm)	8.3 × 12.5 × 3.7 in (212 × 317 × 93 mm)	191691	\$1,675.00
GX-303A	320 g	0.001 g	0.001 g	±0.002 g	3 in (85 mm)	5 × 5 in (128 × 128 mm)	8.3 × 12.5 × 3.7 in (212 × 317 × 93 mm)	191692	\$1,875.00
GX-403A	420 g	0.001 g	0.001 g	±0.002 g	3 in (85 mm)	5 × 5 in (128 × 128 mm)	8.3 × 12.5 × 3.7 in (212 × 317 × 93 mm)	191693	\$1,990.00
GX-603A	620 g	0.001 g	0.001 g	±0.002 g	3 in (85 mm)	5 × 5 in (128 × 128 mm)	8.3 × 12.5 × 3.7 in (212 × 317 × 93 mm)	191694	\$2,595.00
GX-1003A	1,100 g	0.001 g	0.001 g	±0.003 g	3 in (85 mm)	5 × 5 in (128 × 128 mm)	8.3 × 12.5 × 3.7 in (212 × 317 × 93 mm)	191695	\$2,995.00
GX-1603A	1,620 g	0.001g	0.001g	±0.003 g	3 in (85 mm)	5 × 5 in (128 × 128 mm)	8.3 × 12.5 × 3.7 in (212 × 317 × 93 mm)	191696	\$3,405.00

Options/Accessories

Part #	A&D Model #	Description	Price
192662	GXA-03	RS-232C Interface (D-sub 9P male)	\$235.00
192663	GXA-04	Comparator output (requires 192667)	\$225.00
192667	AX-K05692	MiniDIN 8 pin male for GXA-04	\$45.00
192671	GXA-06	Analog output (includes 192673)	\$225.00
192674	GXA-09	Internal rechargeable battery (must be factory installed)	\$470.00
192675	GXA-10	Large glass breeze break	\$330.00
192676	GXA-12	Animal weighing pan (for models of 320 g capacity or higher)	\$145.00
192677	GXA-13	Density determination kit (for 1 mg models only)	\$515.00
192678	GXA-17	Large breeze break with built-in fanless ionizer (static eliminator)	\$925.00
192679	GXA-23-PRINT	External key input interface for SW:137-PRINT foot switch	\$215.00
192680	GXA-23-RZERO	External key input interface for SW:137-REZERo foot switch	\$210.00
192681	GXA-23-PLUG	External key input interface for AX-T-314A-S plug	\$210.00
192682	GXA-24	USB host interface (USB A type)	\$110.00
192683	GXA-25	External fanless ionizer (static eliminator)	\$830.00
192684	GXA-26	External IR switch (MiniDIN 4 pin male)	\$175.00



PRECISION APOLLO GF Series

Standard Features

- Electronically controlled load (ECL) self-diagnostic before internal repeatability test without an external weight in less than 1.5 minutes
- External calibration
- Impact shock detection
- Flow rate display
- RS-232 interface for connecting to printer or PC
- Password protection and anti-theft security slot
- GLP/GMP/ISO compliant to either AD-8127 printer or computer
- Transmits date, time, ID number, serial number, model, manufacturer and calibration data
- Rechargeable battery option for portability
- Super Hybrid Sensor Technology (SHS)
- Reverse backlit LCD display
- Optional glass breeze break
- Underhook weighing

Specifications

Weighing Units

Pound, Carat, Pennyweight, Troy Ounce, Grain, Decimal Ounce, Pound/Ounce

Operating Modes

Counting, Percentage

Power

120/240 V AC adapter

Stabilization Time

Approx. 1.5 seconds (typical in FAST mode)

Display Refresh Rate

5 times/second or 10 times/second

Calibration Weight

GF-203A: 200 g
GF-303A: 300 g
GF-403A: 400 g
GF-603A: 600 g
GF-1003A: 1000 g
GF-1603A: 1500 g

Operating Temperature

41° F to 104° F (5° C to 40° C) RH less than 85% (no condensation)

Est. Weight

18.3 lb (8.3 kg)

Warranty

Five-year limited warranty

Model	Capacity	Readability	Repeatability	Linearity	Weighing Chamber	Pan Size	Dimensions	Part #	List Price
GF-203A	220 g	0.001 g	0.001 g	±0.002 g	3 in H (85 mm H)	128 × 128 mm (5 × 5 in)	212 × 317 × 93 mm (8.3 × 12.5 × 3.7 in)	191707	\$1,375.00
GF-303A	320 g	0.001 g	0.001 g	±0.002 g	3 in H (85 mm H)	128 × 128 mm (5 × 5 in)	212 × 317 × 93 mm (8.3 × 12.5 × 3.7 in)	191708	\$1,550.00
GF-403A	420 g	0.001 g	0.001 g	±0.003 g	3 in H (85 mm H)	128 × 128 mm (5 × 5 in)	212 × 317 × 93 mm (8.3 × 12.5 × 3.7 in)	191709	\$1,675.00
GF-603A	620 g	0.001 g	0.001 g	±0.03 g	3 in H (85 mm H)	128 × 128 mm (5 × 5 in)	212 × 317 × 93 mm (8.3 × 12.5 × 3.7 in)	191710	\$1,975.00
GF-1003A	1,100 g	0.001 g	0.001 g	±0.03 g	3 in H (85 mm H)	128 × 128 mm (5 × 5 in)	212 × 317 × 93 mm (8.3 × 12.5 × 3.7 in)	191711	\$2,375.00
GF-1603A	1,620 g	0.001 g	0.002 g	±0.03 g	3 in H (85 mm H)	128 × 128 mm (5 × 5 in)	212 × 317 × 93 mm (8.3 × 12.5 × 3.7 in)	191712	\$3,055.00

Options/Accessories

Part #	A&D Model #	Description	Price
192662	GXA-03	RS-232C Interface (D-sub 9P male)	\$235.00
192663	GXA-04	Comparator output (requires 192667)	\$225.00
192667	AX-K05692	MiniDIN 8 pin male for GXA-04	\$45.00
192671	GXA-06	Analog output (includes 192673)	\$225.00
192674	GXA-09	Internal rechargeable battery (must be factory installed)	\$470.00
192675	GXA-10	Large glass breeze break	\$330.00
192676	GXA-12	Animal weighing pan (for models of 320 g capacity or higher)	\$145.00
192677	GXA-13	Density determination kit (for 1 mg models only)	\$515.00
192678	GXA-17	Large breeze break with built-in fanless ionizer (static eliminator)	\$925.00
192679	GXA-23-PRINT	External key input interface for SW:137-PRINT foot switch	\$215.00
192680	GXA-23-RZERO	External key input interface for SW:137-REZERo foot switch	\$210.00
192681	GXA-23-PLUG	External key input interface for AX-T-314A-S plug	\$210.00
192682	GXA-24	USB host interface (USB A type)	\$110.00
192683	GXA-25	External fanless ionizer (static eliminator)	\$830.00
192684	GXA-26	External IR switch (MiniDIN 4 pin male)	\$175.00



Apollo GF-1003A

PRECISION FX-iWP Series Washdown

Standard Features

- Washdown IP65 rating
- Compact Super Hybrid Sensor Technology (SHS)
- Vacuum Fluorescent Display (VFD)
- GLP/GMP/ISO compliant to either AD-8121 printer or computer. Transmits date, time, ID number, serial number and calibration data
- RS-232 interface for connecting to printer or PC
- Response indicator function
- Underhook weighing

Specifications

Weighing Units

Pound, Carat, Pennyweight, Troy Ounce, Grain, Pound/Ounce

Operating Modes

Weigh, Count, Percent, Animal Weighing, Statistical, Hold and Comparator

Power

120/240 VAC adapter, approx. 11 VA

Stabilization Time

Approx. 1 second

Sensitivity Drift (10° C to 30° C)

±2 ppm/° C

Display Refresh Rate

5 times/second, 10 times/second or 20 times/second

Calibration Weight

FX-120iWP: 100 g
FX-200iWP: 200 g
FX-300iWP: 300g

Operating Temperature

41° F to 104° F (5° C to 40° C) 85% RH or less (no condensation)

Est. Weight

8 lb (3.5 kg)

Warranty

Five-year limited warranty

Return Policy

A&D Weighing Standard Policy - restock fee may apply

Model	Capacity	Readability	Repeatability	Linearity	Pan Size	Dimensions	Part #	List Price
FX-120iWP	122 g	0.001 g	0.001 g	±0.002 g	Ø 5.12 in (130 mm)	6 × 10.3 × 3.3 in (193 × 263 × 85 mm)	102905	\$1,525.00
FX-200iWP	220 g	0.001 g	0.001 g	±0.002 g	Ø 5.12 in (130 mm)	6 × 10.3 × 3.3 in (193 × 263 × 85 mm)	102906	\$1,605.00
FX-300iWP	320 g	0.001 g	0.001 g	±0.002 g	Ø 5.12 in (130 mm)	6 × 10.3 × 3.3 in (193 × 263 × 85 mm)	102907	\$1,710.00

Options/Accessories

Part #	A&D Model #	Description	Price
98027*	FXi-02	Quick USB interface	\$91.00
98028*	FXi-08	Ethernet interface with WinCT [®] Plus software	\$299.00
98029*	FXi-09	Built-in rechargeable battery	\$335.00
98030	FXi-10	Small breeze break	\$81.00
98031	FXi-11	Large breeze break	\$135.00
97649	TB:648	AC adapter (120 V/220 V)	\$45.00

*Options FXi-02/FXi-08 and FXi-09 cannot be combined and are factory installed only.



Standard Features

- Compact Super Hybrid Sensor Technology (SHS)
- Vacuum Fluorescent Display (VFD)
- GLP/GMP/ISO compliant to either AD-8121 printer or computer. Transmits date, time, ID number, serial number and calibration data
- RS-232 interface for connecting to printer or PC
- Response indicator function
- Weighing chamber
- Underhook weighing

OPTIONS:

- Built-in rechargeable battery
 - Quick USB interface (FXi-02) option
 - LAN-Ethernet interface
 - WinCT[®] communication tools software
- Note: FXi NTEP and FXi models available by special order (internal calibration)*

Specifications

Weighing Units

Pound, Carat, Pennyweight, Troy Ounce, Grain, Pound/Ounce (See technical manual for complete listings)

Operating Modes

Weigh, Count, Percent, Animal Weighing, Statistical, Hold and Comparator

Power Consumption

120/240 V AC adapter, approx. 11 VA

Stabilization Time

Approx. 1 second

Sensitivity Drift (10° C to 30° C)

±2 ppm/° C

Display Refresh Rate

5 times/second, 10 times/second or 20 times/second

Calibration Weight

FX-120i: 100 g
FX-200i: 200 g
FX-300i: 300 g

Operating Temperature

41° F to 104° F (5° C to 40° C) 85% RH or less (no condensation)

Est. Weight

8 lb (3.5 kg)

Warranty

Five-year limited warranty

Return Policy

A&D Weighing Standard Policy - restock fee may apply

Model	Capacity	Readability	Repeatability	Linearity	Pan Size	Dimensions	Part #	List Price
FX-120i	122 g	0.001 g	0.001 g	±0.002 g	130 mm (5.12 in)	7.6 × 10.3 × 3.3 in (193 × 263 × 84.5 mm)	98021	\$1,085.00
FX-200i	220 g	0.001 g	0.001 g	±0.002 g	130 mm (5.12 in)	7.6 × 10.3 × 3.3 in (193 × 263 × 84.5 mm)	98022	\$1,145.00
FX-300i	320 g	0.001 g	0.001 g	±0.002 g	130 mm (5.12 in)	7.6 × 10.3 × 3.3 in (193 × 263 × 84.5 mm)	98023	\$1,195.00

Options/Accessories

Part #	A&D Model #	Description	Price
98027*	FXi-02	Quick USB interface	\$91.00
98028*	FXi-08	Ethernet interface with WinCT [®] Plus software	\$299.00
98029*	FXi-09	Built-in rechargeable battery	\$335.00
98030	FXi-10	Small breeze break	\$81.00
98031	FXi-11	Large breeze break	\$135.00
97649	TB-648	AC adapter (120 V/220 V)	\$45.00
151247	AD-1688	Data logger	\$320.00
196128	AD-8127	Impact dot matrix, statistical printer, includes cable	\$890.00

*Options FXi-02/FXi-08 and FXi-09 cannot be combined and are factory installed only.



PRECISION

AD-4212A Series

Standard Features

- Comparator output (Hi/OK/Lo) feature for manual or automatic operation as well as buzzer function
- GLP/GMP compliant software output
- Breeze break for maximum accuracy and fastest response
- Standard calibration weight
- Simple operator reference card provided
- Multi-weighing units
- Time and date clock function
- Data memory function for weighing, calibration, counting and Hi/OK/Lo values
- Super Hybrid Sensor Technology (SHS)
- WinCT[®] communication tools software
- RS-232 interface for connecting to printer or PC

Specifications

Weighing Units

Milligram, Ounce, Carat, Pennyweight, Troy Ounce, Grain (See technical manual for complete listings)

Operating Modes

Counting, Percentage

Power Supply

120 V AC Adapter, 11 VA

Stabilization Time (typical)

AD-4212A-200, AD-4212B-201: 30 g- 210 g

Approx. 1.0 second

AD-4212B-301: 30 g-210 g Approx. 1.0 second

AD-4212A-600: 30-610 g Approx. 1.1 seconds

AD-4212A-1000: 30-1100 g Approx. 1.1 seconds

I/O Interface Comparator Output

3 level output with buzzer

I/O Interface External Contact Input

Re-zero and print

Calibration Weight (OIML F1) (OPT)

AD-4212A-200, AD-4212B-201, AD-4212B-301: 100 g
AD-4212A-600, AD-4212A-1000: 200 g

Connection Cable

Approx. 2 m (between weighing unit and display unit)

Operating Temperature

41° F to 104° F (5° C to 40° C) 85% RH or less (no condensation)

Est. Weight

8.5lb (4 kg)

Warranty

Five-year limited warranty

Return Policy

A&D Weighing Standard Policy - restock fee may apply

Model	Capacity	Readability	Repeatability	Linearity	Pan Size	Dimensions	Part #	List Price
AD-4212A-200	210 g	1 mg	1 mg	±2 mg	2 × 2 in (50 × 50 mm)	3.2 × 9.1 × 3.5 in (80 × 230 × 90 mm)	97655	\$4,975.00
AD-4212A-600	610 g	1 mg	1 mg	±3 mg	2.8 × 2.8 in (70 × 70 mm)	3.2 × 9.1 × 3.5 in (80 × 230 × 90 mm)	97656	\$5,495.00
AD-4212A-1000	1,100 g	1 mg	1 mg	±3 mg	2.8 × 2.8 in (70 × 70 mm)	3.2 × 9.1 × 3.5 in (80 × 230 × 90 mm)	97657	\$5,695.00

Options/Accessories

Part #	A&D Model #	Description	Price
97672	AD-4212A-01	BCD output (factory installed, four month lead time)	\$581.00
97674	AD-4212A-07	Extension cable, 3 m	\$171.00
97675	AD-4212A-08	Ethernet Interface with WinCT [®]	\$299.00
97676	AD-4212A-19	Stainless steel breeze break (200 g only)	\$110.00



Standard Features

- Compact Super Hybrid Sensor Technology (SHS)
- Vacuum Fluorescent Display (VFD)
- GLP/GMP/ISO compliant to either AD-8121 printer or computer. Transmits date, time, ID number, serial number and calibration data
- RS-232 interface for connecting to printer or PC
- Response indicator function
- Weighing chamber
- Underhook weighing

OPTIONS

- Built-in rechargeable battery
- Quick USB interface (FXi-02) option
- LAN-Ethernet interface
- WinCT[®] communication tools software

Specifications

Weighing Units

Pound, Carat, Pennyweight, Troy Ounce, Grain, Pound/Ounce, (See technical manual for complete listings)

Operating Modes

Weigh, Count, Percent, Animal Weighing, Statistical, Hold and Comparator

Power Consumption

120/240 V AC adapter, approx. 11 VA

Stabilization Time

Approx. 1 second

Sensitivity Drift (10° C to 30° C)

±2 ppm/° C

Display Refresh Rate

5 times/second, 10 times/second or 20 times/second

Calibration Weight

FX-1200i: 1,000 g
FX-2000i: 2,000 g
FX-3000i: 3,000g

Operating Temperature

41° F to 104° F (5° C to 40° C) 85% RH or less (no condensation)

Est. Weight

8 lb (3.5 kg)

Warranty

Five-year limited warranty

Return Policy

A&D Weighing Standard Policy - restock fee may apply

Model	Capacity	Readability	Repeatability	Linearity	Pan Size	Dimensions	Part #	List Price
FX-1200i	1,220 g	0.01 g	0.01 g	±0.02 g	5.90 in (150 mm)	7.6 × 10.3 × 3.3 in (193 × 262.5 × 84.5 mm)	98024	\$1,125.00
FX-2000i	2,200 g	0.01 g	0.01 g	±0.02 g	5.90 in (150 mm)	7.6 × 10.3 × 3.3 in (193 × 262.5 × 84.5 mm)	98025	\$1,185.00
FX-3000i	3,200 g	0.01 g	0.01 g	±0.02 g	5.90 in (150 mm)	7.6 × 10.3 × 3.3 in (193 × 262.5 × 84.5 mm)	98026	\$1,235.00

Options/Accessories

Part#	A&D Model#	Description	Price
98027*	FXi-02	Quick USB interface	\$91.00
98028*	FXi-08	Ethernet interface with WinCT [®] Plus software	\$299.00
98029*	FXi-09	Built-in rechargeable battery	\$335.00
98030	FXi-10	Small breeze break	\$81.00
98031	FXi-11	Large breeze break	\$135.00
97649	TB:648	AC adapter (120 V/220 V)	\$45.00
151247	AD-1688	Data logger	\$320.00
196128	AD-8127	Impact dot matrix, statistical printer, includes cable	\$890.00

*Options FXi-02/FXi-08 and FXi-09 cannot be combined and are factory installed only.



TOPLOADER APOLLO GX Series

Standard Features

- Electronically controlled load (ECL) self-diagnostic before internal repeatability test without an external weight in less than 1.5 minutes
- Internal calibration weight
- Impact shock detection
- Flow rate display
- RS-232 interface for connecting to printer or PC
- Password protection and anti-theft security slot
- GLP/GMP/ISO compliant to either AD-8127 printer or computer
- Transmits date, time, ID number, serial number, model, manufacturer and calibration data
- Rechargeable battery option for portability
- Super Hybrid Sensor Technology (SHS)
- Reverse backlit LCD display
- Optional glass breeze break
- Underhook weighing

Specifications

Weighing Units

Gram, Ounce, Pound, Carat, Pennyweight, Troy Ounce, Grain (See technical manual for complete listing)

Operating Modes

Animal Weighing, Comparator Function, ACAI Counting Function, Percentage, Density Determination, Statistical Calculation

Power

120 VAC adapter, Approx. 30 VA

Stabilization Time

Approx. 1 sec.

Display Refresh Rate

5 times/second, 10 times/second or 20 times/second

Calibration Weight

GX-2002A, GX-3002A: 2,000 g
GX-4002A: 4000 g
GX-6001A, GX-6002A: 5,000 g
GX-10001A, GX-10002A: 10,000 g

Est. Weight

18 lb (8 kg)

Operating Temperature

41° F to 104° F (5° C to 40° C) RH less than 85% (no condensation)

Warranty

Five-year limited warranty

Return Policy

A&D Weighing Standard Policy - restock fee may apply

Model	Capacity	Readability	Repeatability	Linearity	Pan Size	Dimensions	Part #	List Price
GX-2002A	2,200 g	0.01 g	0.01 g	±0.02 g	5 × 5 in (128 × 128 mm)	8.3 × 12.5 × 3.7 in (212 × 317 × 93 mm)	191697	\$1,950.00
GX-3002A	3,200 g	0.01 g	0.01 g	±0.02 g	5 × 5 in (128 × 128 mm)	8.3 × 12.5 × 3.7 in (212 × 317 × 93 mm)	191700	\$2,230.00
GX-4002A	4,200 g	0.01 g	0.01 g	±0.02 g	5 × 5 in (128 × 128 mm)	8.3 × 12.5 × 3.7 in (212 × 317 × 93 mm)	191701	\$2,335.00
GX-6001A	6,200 g	0.1 g	0.1 g	±0.01 g	5 × 5 in (128 × 128 mm)	8.3 × 12.5 × 3.7 in (212 × 317 × 93 mm)	191705	\$2,075.00
GX-6002A	6,200 g	0.01 g	0.01 g	±0.03 g	5 × 5 in (128 × 128 mm)	8.3 × 12.5 × 3.7 in (212 × 317 × 93 mm)	191702	\$2,735.00
GX-10001A	10,200 g	0.1 g	0.1 g	±0.01 g	5 × 5 in (128 × 128 mm)	8.3 × 12.5 × 3.7 in (212 × 317 × 93 mm)	191706	\$3,055.00
GX-10002A	10,200 g	0.01 g	0.02 g	±0.03 g	5 × 5 in (128 × 128 mm)	8.3 × 12.5 × 3.7 in (212 × 317 × 93 mm)	191704	\$3,675.00

Options/Accessories

Part#	A&D Model #	Description	Price
192662	GXA-03	RS-232C Interface (D-sub 9P male)	\$235.00
192663	GXA-04	Comparator output (requires 192667)	\$225.00
192667	AX-K05692	MiniDIN 8 pin male for GXA-04	\$45.00
192671	GXA-06	Analog output (includes 192673)	\$225.00
192674	GXA-09	Internal rechargeable battery (must be factory installed)	\$470.00
192676	GXA-12	Animal weighing pan (for models of 320 g capacity or higher)	\$145.00
192677	GXA-13	Density determination kit (for 1 mg models only)	\$515.00
192678	GXA-17	Large breeze break with built-in fanless ionizer (static eliminator)	\$925.00
192679	GXA-23-PRINT	External key input interface for SW:137-PRINT foot switch	\$215.00
192680	GXA-23-RZERO	External key input interface for SW:137-REZERo foot switch	\$210.00
192681	GXA-23-PLUG	External key input interface for AX-T-314A-S plug	\$210.00
192682	GXA-24	USB host interface (USB A type)	\$110.00
192683	GXA-25	External fanless ionizer (static eliminator)	\$830.00
192684	GXA-26	External IR switch (MiniDIN 4 pin male)	\$175.00



Apollo GX-3002A

TOPLOADER APOLLO GF Series

Standard Features

- Electronically controlled load (ECL) self-diagnostic before internal repeatability test without an external weight in less than 1.5 minutes
- External calibration
- Impact shock detection
- Flow rate display
- RS-232 interface for connecting to printer or PC
- Password protection and anti-theft security slot
- GLP/GMP/ISO compliant to either AD-8127 printer or computer
- Transmits date, time, ID number, serial number, model, manufacturer and calibration data
- Rechargeable battery option for portability
- Super Hybrid Sensor Technology (SHS)
- Reverse backlit LCD display
- Optional glass breeze break
- Underhook weighing

Specifications

Weighing Units

Pound, Carat, Pennyweight, Troy Ounce, Grain, Decimal Ounce, Pound/Ounce

Operating Modes

Counting, Percentage

Power

120/240 V AC adapter

Stabilization Time

Approx. 1.5 seconds (typical in FAST mode)

Display Refresh Rate

5 times/second or 10 times/second

Calibration Weight

GF-1202A: 1 kg
GF-2002A: 2 kg
GF-3002A: 3 kg
GF-4002A: 4 kg
GF-6002A: 6 kg
GF-6001A: 6 kg
GF-10001A: 10 kg
GF-10002A: 10 kg

Operating Temperature

41° F to 104° F (5° C to 40° C) RH less than 85% (no condensation)

Est. Weight

18.3 lb (8.3 kg)

Warranty

Five-year limited warranty

Model	Capacity	Readability	Repeatability	Linearity	Pan Size	Dimensions	Part #	List Price
GF-1202A	1,220 g	0.01 g	0.01 g	±0.02 g	165 × 165 mm (6.5 × 6.5 in)	212 × 317 × 93 mm (8.3 × 12.5 × 3.7 in)	191713	\$1,385.00
GF-2002A	2,200 g	0.01 g	0.01 g	±0.02 g	128 × 128 mm (5 × 5 in)	212 × 317 × 93 mm (8.3 × 12.5 × 3.7 in)	191714	\$1,425.00
GF-3002A	3,200 g	0.01 g	0.01 g	±0.02 g	128 × 128 mm (5 × 5 in)	212 × 317 × 93 mm (8.3 × 12.5 × 3.7 in)	191715	\$1,475.00
GF-4002A	4,200 g	0.01 g	0.01 g	±0.02 g	128 × 128 mm (5 × 5 in)	212 × 317 × 93 mm (8.3 × 12.5 × 3.7 in)	191716	\$1,890.00
GF-6002A	6,200 g	0.01 g	0.01 g	±0.03 g	128 × 128 mm (5 × 5 in)	212 × 317 × 93 mm (8.3 × 12.5 × 3.7 in)	191717	\$2,310.00
GF-6001A	6,200 g	0.1 g	0.1 g	±0.1 g	128 × 128 mm (5 × 5 in)	212 × 317 × 93 mm (8.3 × 12.5 × 3.7 in)	192486	\$1,575.00
GF-10001A	10,200 g	0.1 g	0.1 g	±0.1 g	128 × 128 mm (5 × 5 in)	212 × 317 × 93 mm (8.3 × 12.5 × 3.7 in)	192487	\$1,645.00
GF-10002A	10,200 g	0.01 g	0.1 g	±0.03 g	165 × 165 mm (6.5 × 6.5 in)	212 × 317 × 93 mm (8.3 × 12.5 × 3.7 in)	191718	\$2,850.00

Options/Accessories

Part #	A&D Model #	Description	Price
192662	GXA-03	RS-232C Interface (D-sub 9P male)	\$235.00
192663	GXA-04	Comparator output (requires 192667)	\$225.00
192667	AX-K05692	MiniDIN 8 pin male for GXA-04	\$45.00
192671	GXA-06	Analog output (includes 192673)	\$225.00
192674	GXA-09	Internal rechargeable battery (must be factory installed)	\$470.00
192675	GXA-10	Large glass breeze break	\$330.00
192676	GXA-12	Animal weighing pan (for models of 320 g capacity or higher)	\$145.00
192677	GXA-13	Density determination kit (for 1 mg models only)	\$515.00
192678	GXA-17	Large breeze break with built-in fanless ionizer (static eliminator)	\$925.00
192679	GXA-23-PRINT	External key input interface for SW:137-PRINT foot switch	\$215.00
192680	GXA-23-RZERO	External key input interface for SW:137-REZERo foot switch	\$210.00
192681	GXA-23-PLUG	External key input interface for AX-T-314A-S plug	\$210.00
192682	GXA-24	USB host interface (USB A type)	\$110.00
192683	GXA-25	External fanless ionizer (static eliminator)	\$830.00
192684	GXA-26	External IR switch (MiniDIN 4 pin male)	\$175.00



Apollo GF-3002A

TOPLOADER FX-iWP Series Washdown

Standard Features

- Washdown IP65 rating
- Compact Super Hybrid Sensor Technology (SHS)
- Vacuum Fluorescent Display (VFD)
- GLP/GMP/ISO compliant to either AD-8121 printer or computer. Transmits date, time, ID number, serial number and calibration data
- RS-232 interface for connecting to printer or PC
- Response indicator function
- Underhook weighing

Specifications

Weighing Units

Pound, Carat, Pennyweight, Troy Ounce, Grain, Pound/Ounce

Operating Modes

Weigh, Count, Percent, Animal Weighing, Statistical, Hold and Comparator

Power

120/240 VAC adapter, approx. 11 VA

Stabilization Time

Approx. 1 second

Sensitivity Drift (10° C to 30° C)

±2 ppm/° C

Display Refresh Rate

5 times/second, 10 times/second or 20 times/second

Calibration Weight

FX1200iWP: 1,000 g
FX-2000iWP: 2,000 g
FX-3000iWP: 3,000 g

Operating Temperature

41° F to 104° F (5° C to 40° C) 85% RH or less (no condensation)

Est. Weight

8 lb (3.5 kg)

Warranty

Five-year limited warranty

Return Policy

A&D Weighing Standard Policy - restock fee may apply

Model	Capacity	Readability	Repeatability	Linearity	Pan Size	Dimensions	Part #	List Price
FX-1200iWP	1,220 g	0.01 g	0.01 g	±0.02 g	Ø 5.90 in (150 mm)	6 × 10.3 × 3.3 in (193 × 263 × 85 mm)	102908	\$1,515.00
FX-2000iWP	2,200 g	0.01 g	0.01 g	±0.02 g	Ø 5.90 in (150 mm)	6 × 10.3 × 3.3 in (193 × 263 × 85 mm)	102909	\$1,605.00
FX-3000iWP	3,200 g	0.01 g	0.01 g	±0.02 g	Ø 5.90 in (150 mm)	6 × 10.3 × 3.3 in (193 × 263 × 85 mm)	102910	\$1,705.00

Options/Accessories

Part #	A&D Model #	Description	Price
98027*	FXi-02	Quick USB interface	\$91.00
98028*	FXi-08	Ethernet interface with WinCT [®] Plus software	\$299.00
98029*	FXi-09	Built-in rechargeable battery	\$335.00
98030	FXi-10	Small breeze break	\$81.00
98031	FXi-11	Large breeze break	\$135.00
97649	TB:648	AC adapter (120 V/220 V)	\$45.00

*Options FXi-02/FXi-08 and FXi-09 cannot be combined and are factory installed only.



TOPLOADER EJ NEWTON Series

Standard Features

- Easy-to-read seven segment LCD display with backlight
- 10 units of measurement
- Battery operated (Four AA not included)
- Selectable modes: weight, count, percentage and specific gravity
- 120 VAC adaptor included (230VAC optional)



EJ-200

Specifications

Weighing Units

Carat, Pennyweight, Troy Ounce, Decimal Ounce, Decimal Pound (See technical manual for complete listing)

Operating Modes

Specific Gravity, Counting, Percentage, Checkweighing

Power

120 VAC adapter
Four AA size dry-cell batteries (not included) 70 hours operation

Stabilization Time

< 2 seconds

Sensitivity Drift (10° C to 30° C)

±20 ppm/° C

Display Type

7 segment LCD with backlight
(character height 16 mm)

Operating Temperature

14° F to 104° F (-10° C to 40° C) less than 85% R.H.
(no condensation)

Calibration Weight

EJ-123, EJ-120: 100 g
EJ-200: 200 g
EJ-300: 300 g
EJ-410: 400 g
EJ-610: 600 g
EJ-1500: 1,500 g
EJ-2000: 2,000 g
EJ-3000: 3,000 g
EJ-4100: 4,000 g
EJ-6100: 6,000 g

Est. Weight

EJ-123, EJ-120, EJ-200, EJ-300, EJ-410, EJ-610: 850 g
EJ-1500, EJ-2000, EJ-3000, EJ-4100, EJ-6100: 1,100g

Warranty

Five-year limited warranty

Return Policy

A&D Weighing Standard Policy - restock fee may apply

Model	Capacity	Readability	Repeatability	Linearity	Pan Size	Dimensions	Part #	List Price
EJ-123	120 g	0.001 g	0.003 g	0.003 g	Ø 4.3 in (110 mm)	7.5 × 8.6 × 2.2 in (190 × 218 × 55 mm)	163274	\$545.00
EJ-120	120 g	0.01 g	0.01 g	±0.01 g	Ø 4.3 in (110 mm)	7.5 × 8.6 × 2.2 in (190 × 218 × 55 mm)	112410	\$280.00
EJ-200	210 g	0.01 g	0.01 g	±0.01 g	Ø 4.3 in (110 mm)	7.5 × 8.6 × 2.2 in (190 × 218 × 55 mm)	112411	\$350.00
EJ-300	310 g	0.01 g	0.01 g	±0.02 g	Ø 4.3 in (110 mm)	7.5 × 8.6 × 2.2 in (190 × 218 × 55 mm)	112412	\$405.00
EJ-410	410 g	0.01 g	0.01 g	±0.02 g	Ø 4.3 in (110 mm)	7.5 × 8.6 × 2.2 in (190 × 218 × 55 mm)	112413	\$445.00
EJ-610	610 g	0.01 g	0.01 g	±0.02 g	Ø 4.3 in (110 mm)	7.5 × 8.6 × 2.2 in (190 × 218 × 55 mm)	112414	\$575.00
EJ-1500	1,500 g	0.1 g	0.1 g	±0.1 g	5 × 5.5 in (127 × 140 mm)	7.5 × 8.6 × 2.2 in (190 × 218 × 55 mm)	112415	\$281.00
EJ-2000	2,100 g	0.1 g	0.1 g	±0.1 g	5 × 5.5 in (127 × 140 mm)	7.5 × 8.6 × 2.2 in (190 × 218 × 55 mm)	112416	\$340.00
EJ-3000	3,100 g	0.1 g	0.1 g	±0.2 g	5 × 5.5 in (127 × 140 mm)	7.5 × 8.6 × 2.2 in (190 × 218 × 55 mm)	112417	\$410.00
EJ-4100	4,100 g	0.1 g	0.1 g	±0.2 g	5 × 5.5 in (127 × 140 mm)	7.5 × 8.6 × 2.2 in (190 × 218 × 55 mm)	112418	\$475.00
EJ-6100	6100 g	0.1 g	0.1 g	±0.2 g	5 × 5.5 in (127 × 140 mm)	7.5 × 8.6 × 2.2 in (190 × 218 × 55 mm)	112419	\$530.00

Options/Accessories

Part#	A&D Model #	Description	Price
112426	EJ-02	USB interface with cable	\$89.00
112427	EJ-03	RS-232 interface with cable	\$79.00
112428	EJ-07	Underhook for EJ-3000, EJ-4100 and EJ-6100	\$71.00
112429	EJ-08	Underhook for EJ-1500 and EJ-2000	\$71.00
112430	EJ-11	Breeze break	\$71.00
112431	EJ-12	Carrying case	\$71.00
112432	EJ-13	Density determination kit	\$81.00
97766	TB:662	AC adapter, 120 V	\$44.00
97767	TB:164	AC adapter, 220 V	\$55.00
151247	AD-1688	Data logger	\$320.00



EJ-2000

TOPLOADER EK-i Series

Standard Features

- Backlit weight display
- Remote zeroing
- Easy to install NiCad battery option
- RS-232 interface for connecting to printer or PC

Specifications

Weighing Units

Carat, Pennyweight, Troy Ounce, Newton, Decimal Ounce, Decimal Pound

Operating Modes

Counting, Percentage

Power

120 VAC adapter (Optional Ni-MH battery pack)

Stabilization Time

< 2 seconds

Sensitivity Drift (10° C to 30° C)

±20 ppm/° C

Display Type

7 segment LCD with backlight
(character height 16 mm)

Operating Temperature

14° F to 104° F (-10° C to 40° C) less than 85% R.H.
(no condensation)

Calibration Weight

EK-120i: 120 g
EK-200i: 200 g
EK-300i: 300 g
EK-410i: 400 g
EK-610i: 400 g
EK-2000i: 2,000 g
EK-3000i: 3,000 g
EK-4100i: 4,000 g
EK-6100i: 6,000 g

Est. Weight

3.5 lb (1.5 kg)

Warranty

Five-year limited warranty

Return Policy

A&D Weighing Standard Policy - restock fee may apply

Model	Capacity	Readability	Repeatability	Linearity	Pan Size	Dimensions	Part #	List Price
EK-120i	120 g	0.01 g	0.01 g	±0.01 g	110 mm (Ø 4.3 in)	190 × 218 × 55 mm (7.5 × 8.6 × 2.2 in)	97747	\$525.00
EK-200i	200 g	0.01 g	0.01 g	±0.01 g	110 mm (Ø 4.3 in)	190 × 218 × 55 mm (7.5 × 8.6 × 2.2 in)	97748	\$560.00
EK-300i	300 g	0.01 g	0.01 g	±0.02 g	110 mm (Ø 4.3 in)	190 × 218 × 55 mm (7.5 × 8.6 × 2.2 in)	97749	\$580.00
EK-410i	400 g	0.01 g	0.01 g	±0.02 g	110 mm (Ø 4.3 in)	190 × 218 × 55 mm (7.5 × 8.6 × 2.2 in)	97750	\$655.00
EK-610i	600 g	0.01 g	0.01 g	±0.02 g	110 mm (Ø 4.3 in)	190 × 218 × 55 mm (7.5 × 8.6 × 2.2 in)	97751	\$770.00
EK-2000i	2,000 g	0.1 g	0.1 g	±0.1 g	133 × 170 mm (5.2 × 6.7 in)	190 × 218 × 55 mm (7.5 × 8.6 × 2.2 in)	97754	\$565.00
EK-3000i	3,000 g	0.1 g	0.1 g	±0.2 g	133 × 170 mm (5.2 × 6.7 in)	190 × 218 × 55 mm (7.5 × 8.6 × 2.2 in)	97755	\$615.00
EK-4100i	4,000 g	0.1 g	0.1 g	±0.2 g	133 × 170 mm (5.2 × 6.7 in)	190 × 218 × 55 mm (7.5 × 8.6 × 2.2 in)	97756	\$730.00
EK-6100i	6,000 g	0.1 g	0.1 g	±0.2 g	133 × 170 mm (5.2 × 6.7 in)	190 × 218 × 55 mm (7.5 × 8.6 × 2.2 in)	97757	\$910.00

Options/Accessories

Part #	A&D Model #	Description	Price
97760	EKW-04i	Comparator/relay outputs/buzzer	\$170.00
97761	EKW-07i	Underhook for EK-4100i/6100i/6000i/12Ki/EW-12Ki	\$55.00
97762	EKW-09i	NiCad battery pack	\$220.00
97764	AX:3005824-5S	Protective dust cover (not in use)	\$15.00
97605	AD-100-2	Anti-theft device	\$77.00
97766	TB:662	AC adapter (120 V)	\$44.00
97767	TB:164	AC adapter (240 V)	\$55.00
151247	AD-1688	Data logger	\$320.00



Standard Features

- Backlit weight display
- Remote zeroing
- Easy-to-install NiCad battery option
- RS-232 in terface for connecting to printer or PC
- Triple range

Specifications

Weighing Units

Carat, Pennyweight, Troy Ounce, Decimal Ounce, Decimal Pound

Operating Mode

Counting, Percentage, Comparator

Power

AC adapter or Ni-MH battery pack (option)

Stabilization Time

< 2 seconds

Sensitivity Drift (10° C to 30° C)

±20 ppm/° C

Operating Temperature

14° F to 104° F (-10° C to 40° C) less than 85% R.H. (no condensation)

Calibration Weight

EW-150i: 150 g

Est. Weight

3.5 lb (1.5 kg)

Warranty

Five-year limited warranty

Return Policy

A&D Weighing Standard Policy - restock fee may apply

Model	Capacity	Readability	Repeatability	Linearity	Pan Size	Dimensions	Part #	List Price
EW-150i	30 g / 60 g / 150 g	0.01 g / 0.02 g / 0.1 g	0.01 g / 0.02 g / 0.05 g	±0.01 g / ±0.02 g / ±0.05 g	Ø 4.3 in (110 mm)	190 × 218 × 55 mm (7.5 × 8.6 × 2.2 in)	97768	\$435.00

Options/Accessories

Part #	A&D Model #	Description	Price
97760	EKW-04i	Comparator/relay outputs/buzzer	\$170.00
97761	EKW-07i	Underhook for EK-4100i/6100i/6000i/12Ki/EW-12Ki	\$55.00
97762	EKW-09i	NiCad battery pack	\$220.00
97764	AX:3005824-5S	Protective dust cover (not in use)	\$15.00
97605	AD-100-2	Anti-theft device	\$77.00
97766	TB:662	AC adapter (120 V)	\$44.00
97767	TB:164	AC adapter (240 V)	\$55.00
151247	AD-1688	Data logger	\$320.00



HIGH CAPACITY GX-M Series

Standard Features

- Internal calibration
- Auto environmental compensation
- IP65/NEMA Type 4
- RS-232 interface for connecting to printer or PC
- Data memory function
- Quick reference operation card
- Time and date
- Vacuum Fluorescent Display (VFD)
- Underhook weighing

Specifications

Weighing Units

Pound, Carat, Pennyweight, Troy Ounce, Grain, Decimal Ounce, Pound/Ounce

Operating Modes

Counting, Percentage

Power

120 /240 V AC adapter

Stabilization time

Approx. 1.5 seconds

Sensitivity Drift (10° C to 30° C / 50° F to 86° F)

GX-8202M: ±2 ppm/°C
 GX-8202MD: ±3 ppm/°C
 GX-10202M: ±2 ppm/°C
 GX-12001M, GX-22001M, GX-32001M: ±3 ppm/°C
 GX-32001MD: ±5 ppm/°C

Calibration Weight

GX-8202M/MD: 2kg to 8kg
 GX-10202M: 2kg to 10kg
 GX-12001M: 5kg, 10kg
 GX-22001M: 5kg, 10kg, 20kg
 GX-32001M/MD: 5kg, 10kg, 20kg, 30kg

Operating Temperature

41° F to 104° F (-5° C to 40° C)

Est. Weight

18.3 lb (8.3 kg)

Warranty

Five-year limited warranty

Return Policy

A&D Weighing Standard Policy - restock fee may apply

Model	Capacity	Readability	Repeatability	Linearity	Pan Size	Dimensions	Part #	List Price
GX-8202M	8.2 kg	0.01 g	0.01 g	±0.03 g	10.62 × 8.26 in (270 × 210 mm)	11.81 × 13.98 × 4.37 in (300 × 355 × 111 mm)	207408	\$3,715.00
GX-8202MD	2.2 kg / 8.2 kg	0.01 g / 0.1 g	0.01 g / 0.05 g	±0.02 g / ±0.1 g	10.62 × 8.26 in (270 × 210 mm)	11.81 × 13.98 × 4.37 in (300 × 355 × 111 mm)	207409	\$3,245.00
GX-10202M	10.2 kg	0.01 g	0.01 g	±0.03 g	10.62 × 8.26 in (270 × 210 mm)	11.81 × 13.98 × 4.37 in (300 × 355 × 111 mm)	207410	\$3,995.00
GX-12001M	12.2 kg	0.1 g	0.1 g	±0.2 g	10.62 × 8.26 in (270 × 210 mm)	11.81 × 13.98 × 4.37 in (300 × 355 × 111 mm)	207411	\$3,375.00
GX-22001M	22.2 kg	0.1 g	0.1 g	±0.2 g	10.62 × 8.26 in (270 × 210 mm)	11.81 × 13.98 × 4.37 in (300 × 355 × 111 mm)	207412	\$3,656.00
GX-32001M	32.2 kg	0.1 g	0.1 g	±0.2 g	10.62 × 8.26 in (270 × 210 mm)	11.81 × 13.98 × 4.37 in (300 × 355 × 111 mm)	207413	\$4,215.00
GX-32001MD	6.2 kg / 32.2 kg	0.1 g/1 g	0.1 g / 0.5 g	±0.2 g / ±1 g	10.62 × 8.26 in (270 × 210 mm)	11.81 × 13.98 × 4.37 in (300 × 355 × 111 mm)	207414	\$3,270.00

Options/Accessories

Part#	A&D Model#	Description	Price
207431	GX-04K*	Comparator/output and RS-232C/20 mA interface	\$450.00
207432	GX-06K*	Analog output/20 mA interface	\$525.00
97784	GX-07K**	Waterproof cable for standard RS-232C	\$321.00
102899	GXK-12	Animal weighing pan	\$861.00
102898	GXK-31	Draft shield	\$120.00
97605	AD-100-2	Anti-theft device	\$77.00
97785	AX:073007197A	Protective in-use cover	\$22.00
97649	TB:648	AC adapter (120 V/220 V)	\$45.00
151247	AD-1688	Data logger	\$320.00
196128	AD-8127	Impact dot matrix, statistical printer, includes cable	\$890.00

*GX-04K, GX-06K, replace standard RS-232C and cannot be used at the same time.

IP65 rating does not apply when the GX-04K or the GX-06K is installed.

**Use the GX-07K optional waterproof RS-232C cable, in order to use the standard RS-232 interface for water and dust proof (IP65).



HIGH CAPACITY GF-M Series

Standard Features

- IP65/NEMA Type 4
- RS-232 interface for connecting to printer or PC
- Quick reference operation card
- Time and date
- Vacuum fluorescent display (VFD)
- Interval time setting
- Underhook weighing

Specifications

Weighting Units

Pound, Carat, Pennyweight, Troy Ounce, Grain, Decimal Ounce, Pound/Ounce

Operating Modes

Counting, Percentage

Power

120/240 V AC adapter

Stabilization Time

Approx. 1.5 seconds (typical in FAST mode)

Sensitivity Drift (10° C to 30° C / 50° F to 86° F)

GF-8202M: ±2 ppm/°C
 GF-8202MD: ±3 ppm/°C
 GF-10202M: ±2 ppm/°C
 GF-12001M, GX-22001M, GX-32001M: ±3 ppm/°C
 GF-32001MD: ±5 ppm/°C

Calibration Weight

GF-8202M/MD: 2kg to 8kg
 GF-10202M: 2kg to 10kg
 GF-12001M: 5kg, 10kg
 GF-22001M: 5kg, 10kg, 20kg
 GF-32001M/MD: 5kg, 10kg, 20kg, 30kg

Display Refresh Rate

5 times/second or 10 times/second

Operating Temperature

41° F to 104° F (5° C to 40° C) RH less than 85% (no condensation)

Est. Weight

18.3 lb (8.3 kg)

Warranty

Five-year limited warranty

Model	Capacity	Readability	Repeatability	Linearity	Pan Size	Dimensions	Part #	List Price
GF-8202M	8.2 kg	0.01 g	0.01 g	±0.03 g	10.62 × 8.26 in (270 × 210 mm)	300 × 355 × 111 mm (11.81 × 13.98 × 4.37 in)	207415	\$3,540.00
GF-8202MD	2.2 kg/8.2 kg	0.01 g/0.1 g	0.01 g/0.05 g	±0.02 g/±0.1 g	10.62 × 8.26 in (270 × 210 mm)	300 × 355 × 111 mm (11.81 × 13.98 × 4.37 in)	207416	\$2,990.00
GF-10202M	10.2 kg	0.01 g	0.01 g	±0.03 g	10.62 × 8.26 in (270 × 210 mm)	300 × 355 × 111 mm (11.81 × 13.98 × 4.37 in)	207417	\$3,800.00
GF-12001M	12.2 kg	0.1 g	0.1 g	±0.2 g	10.62 × 8.26 in (270 × 210 mm)	300 × 355 × 111 mm (11.81 × 13.98 × 4.37 in)	207418	\$3,205.00
GF-22001M	22.2 kg	0.1 g	±0.2 g	0.1 g	10.62 × 8.26 in (270 × 210 mm)	300 × 355 × 111 mm (11.81 × 13.98 × 4.37 in)	207419	\$3,400.00
GF-32001M	32.2 kg	0.1 g	±0.2 g	0.1 g	10.62 × 8.26 in (270 × 210 mm)	300 × 355 × 111 mm (11.81 × 13.98 × 4.37 in)	207420	\$3,985.00
GF-32001MD	6.2/32.2 kg	0.1/1 g	±0.5 g/0.1 g	0.2 g/1 g	10.62 × 8.26 in (270 × 210 mm)	300 × 355 × 111 mm (11.81 × 13.98 × 4.37 in)	207422	\$2,999.00

Options/Accessories

Part #	A&D Model #	Description	Price
207431	GX-04K*	Comparator/output and RS-232C/20 mA interface	\$450.00
207432	GX-06K*	Analog output/20 mA interface	\$525.00
97784	GX-07K**	Waterproof cable for standard RS-232C	\$321.00
102899	GXK-12	Animal weighing pan	\$861.00
102898	GXK-31	Draft shield	\$120.00
97605	AD-100-2	Anti-theft device	\$77.00
97785	AX:073007197A	Protective in-use cover	\$22.00
97649	TB:648	AC adapter (120 V/220 V)	\$45.00
151247	AD-1688	Data logger	\$320.00
196128	AD-8127	Impact dot matrix, statistical printer, includes cable	\$890.00

*GX-04K, GX-06K, replace standard RS-232C and cannot be used at the same time. IP65 rating does not apply when the GX-04K or the GX-06K is installed.

**Use the GX-07K optional waterproof RS-232C cable, in order to use the standard RS-232 interface for water and dust proof (IP65).



HIGH CAPACITY GP Series

Standard Features

- IP65/NEMA Type 4
- Internal calibration weight with manual, interval or auto-environmental compensation
- RS-232 interface for connecting to printer or PC
- Data-collection software
- Auto re-zero function
- Time and date
- Bright blue fluorescent display
- Adjustable swing arm display
- Die cast aluminum body with stainless weighing pan
- Detached digital weight indicator (KS models only)

Specifications

Weighing Units:

Carat, Pennyweight, Troy Ounce, Grain, Decimal Ounce, Decimal Pound, Pound/Ounce

Operating Modes:

Counting, Percentage

Power:

Approx. 30 VA (supplied to the AC adapter)

Stabilization Time:

Approx. 1.5 seconds (typical in FAST mode)

Sensitivity Drift (-10 °C to 30 °C):

GP-12K, GP-20K, GP-30K, GP-30KS: ±3 ppm/° C
 GP-32K, GP-32KS, GP-40K: ±5 ppm/° C
 GP-60K, GP-60KS, GP-61K, GP-61KS, GP-100K, GP-100KS: ±6 ppm/° C
 GP102K: ±10 ppm/° C

Height with Column

652 mm

Calibration Weight:

GP-12K: 5 kg/10 kg
 GP-20K: 10 kg/20 kg
 GP-30K, GP-30KS, GP-32KS: 20 kg/30 kg
 GP-40K: 20/30/40 kg
 GP-60K, GP-60KS: 30/40/50/60 kg
 GP-61K, GP-61KS: 20/30/40/50/60 kg
 GP-100K, GP-100KS, GP-102K: 60/80/100 kg

Operating Temperature:

41° F to 104° F (5° C to 40° C) RH less than 85% (no condensation)

Est. Weight:

Approx. 39.7 lb (18 kg)

Warranty:

Five-year limited

Return Policy:

A&D Weighing Standard Policy - restock fee may apply

Model	Capacity	Readability	Repeatability	Linearity	Pan Size	Dimensions	Part #	List Price
GP-12K	12 kg	0.1 g	0.1 g	±0.2 g	384 × 344 mm (15 × 13 in)	372 × 615 × 130 mm (14.6 × 24.2 × 5.1 in)	97802	\$3,500.00
GP-20K	21 kg	0.1 g	0.1 g	±0.2 g	384 × 344 mm (15 × 13 in)	372 × 615 × 130 mm (14.6 × 24.2 × 5.1 in)	97803	\$3,850.00
GP-30K	31 kg	0.1 g	0.1 g	±0.2 g	384 × 344 mm (15 × 13 in)	344 × 442 × 139 mm (13.5 × 17.4 × 5.5 in)	97805	\$4,650.00
GP-30KS	31 kg	0.1 g	-	-	384 × 344 mm (15 × 13 in)	344 × 442 × 139 mm (13.5 × 17.4 × 5.5 in)	97810	\$4,895.00
GP-32K	31 kg / 6 kg	1/0.1 g	0.5 g / 0.1 g	±1 / ±2 g	384 × 344 mm (15 × 13 in)	372 × 615 × 130 mm (14.6 × 24.2 × 5.1 in)	97804	\$3,185.00
GP-32KS	31 kg / 6 kg	1 / 0.1 g	-	-	384 × 344 mm (15 × 13 in)	372 × 615 × 130 mm (14.6 × 24.2 × 5.1 in)	102901	\$3,550.00
GP-40K	41 kg	0.5 g	0.5 g	±1 g	384 × 344 mm (15 × 13 in)	372 × 615 × 130 mm (14.6 × 24.2 × 5.1 in)	97806	\$4,250.00
GP-60K	61 kg	1 g	0.7 g	±1 g	384 × 344 mm (15 × 13 in)	372 × 615 × 130 mm (14.6 × 24.2 × 5.1 in)	97807	\$5,225.00
GP-60KS	61 kg	1 g	-	-	384 × 344 mm (15 × 13 in)	372 × 615 × 130 mm (14.6 × 24.2 × 5.1 in)	102902	\$5,450.00
GP-61K	61 kg	0.1 g	0.2 g	±0.5 g	384 × 344 mm (15 × 13 in)	372 × 615 × 130 mm (14.6 × 24.2 × 5.1 in)	102900	\$5,995.00
GP-61KS	61 kg	0.1 g	-	-	384 × 344 mm (15 × 13 in)	372 × 615 × 130 mm (14.6 × 24.2 × 5.1 in)	102903	\$5,825.00
GP-100K	100 kg	1 g	1 g	±2 g	384 × 344 mm (15 × 13 in)	372 × 615 × 130 mm (14.6 × 24.2 × 5.1 in)	97808	\$5,500.00
GP-100KS	101 kg	1 g	-	-	384 × 344 mm (15 × 13 in)	372 × 615 × 130 mm (14.6 × 24.2 × 5.1 in)	97811	\$5,925.00
GP-102K	101 kg / 61 kg	10 / 1 g	5 / 1 g	±10 / ±2 g	384 × 344 mm (15 × 13 in)	372 × 615 × 130 mm (14.6 × 24.2 × 5.1 in)	97809	\$4,995.00

Options/Accessories

Part#	A&D Model#	Description	Price
97607	AD-1682	Rechargeable battery pack	\$710.00
97608	AD-8920	Universal remote display	\$275.00
97813	GP-04	Comparator output with buzzer	\$264.00
97814	GP-06	Analog output (replaces standard RS-232C)	\$865.00
97815	GP-07	GP extension cable (factory installed 120 day lead time)	\$319.00
97816	GP-20	Underhook GP-12 kg thru 40 kg	\$189.00
97817	GP-21	Underhook GP-60 kg thru 102 kg	\$189.00
97605	AD-100-2	Anti-theft device	\$77.00
97820	07:3004753	Protective in-use cover	\$25.00
97613	TB:136	AC adapter (120 V) standard with unit	\$44.00
97614	TB:137	AC adapter (220 V)	\$55.00
97609	AD-8922	Remote controller	\$650.00
102904	GP-12	Animal weighing pan	\$1,709.00
151247	AD-1688	Data logger	\$320.00
97612	SW:128	Foot switch	\$85.00
196128	AD-8127	Impact dot matrix, statistical printer, includes cable	\$890.00



INTRINSICALLY SAFE EK-AEP Series

Standard Features

- LCD display
- ATEX and FM approved (Class I, Division 1, groups C and D)
- Optical data output
- 200 hours of battery operation*
- Auto power off
- Counting/Percentage/Specific Gravity modes
- Optical data output



EK-300AEP

Specifications

Weighing Units:

Carat, Pennyweight, Troy Ounce, Newton, Decimal Ounce, Decimal Pound

Operating Modes:

Counting, Percentage, Specific Gravity

Power:

Four AA batteries
(Battery life determined with backlight off with four AA batteries. The EK-EAP must be used with any of the following to maintain FM integrity: Duracell AA alkaline MN 1500 LR6, Energizer AA E91 alkaline LR6 AM3, Panasonic AA alkaline LR6 (XJ). Do not mix type or new/used batteries.)

Stabilization Time:

< 2 seconds

Sensitivity Drift (10 °C to 30 °C):

±20 ppm/°C

Calibration Weight:

EK-300AEP: 300 g
EK-3000AEP: 3,000 g
EK-12KAEP: 10 kg

Est. Weight:

3.5 lb (1.5 kg)

Operating Temperature:

32 °F to 104 °F (0 °C to 40 °C)

Warranty:

Two-year limited

Return Policy:

A&D Weighing Standard Policy - restock fee may apply

Approvals:

FM/FMc
ATEX



Model	Capacity	Readability	Repeatability	Linearity	Pan Size	Dimensions	Part #	List Price
EK-300AEP	300 g	0.01 g	0.01 g	±0.02 g	110 mm (Ø4.33 in)	190 × 218 × 55 mm (7.5 × 8.6 × 2.2 in)	199565	\$1,650.00
EK-3000AEP	3,000 g	0.1 g	0.1 g	±0.2 g	133 mm × 170 mm (5.24 in × 6.69 in)	190 × 218 × 55 mm (7.5 × 8.6 × 2.2 in)	199566	\$1,750.00
EK-12KAEP	12,000 g	1 g	1 g	±1 g	133 mm × 170 mm (5.24 in × 6.69 in)	190 × 218 × 55 mm (7.5 × 8.6 × 2.2 in)	199567	\$1,950.00

Options/Accessories

Part #	A&D Model #	Description	Price
177696	EJ-12	Carrying case	\$69.00
202077	AD-1611	Safe area serial output module (requires a fiber optic cable)	\$459.00
202074	AX-KS5456-010	Fiber Optic Cable (10m)	\$328.00
202075	AX-KS5456-030	Fiber Optic Cable (30m)	\$590.00
202076	AX-KS5456-060	Fiber Optic Cable (60m)	\$850.00

*Battery life determined with backlight off with four AA batteries. The EK-EAP must be used with any of the following to maintain FM integrity: Duracell AA alkaline MN 1500 LR6, Energizer AA E91 alkaline LR6 AM3, Panasonic AA alkaline LR6 (XJ). Do not mix type or new/used batteries.



EK-3000AEP

MS-70 / MX-50 / MF-50 / ML-50

Standard Features

- Fast and uniform heating with halogen lamp and uniquely designed (secondary radiation assist) SRA filter
- WinCT[®] communication tools software
- Sodium tartrate dihydrate is provided as a stable moisture content for accuracy checks of the analyzer
- Vacuum fluorescent display (VFD)
- Glass window for heating check and easy cleaning
- Self-check function
- Quick reference card
- RS-232 interface for connecting to printer or PC
- GLP/ GMP/GCP/ISO compliant with time and date, ID, calibration data and check record outputs

Specifications

Operating Modes:

Wet base, Dry base, Solid content, Ratio

Measurement Programs:

Standard, Automatic, Timer, Manual

Power:

120 VAC

Drying Temperature:

MS-70: 30° C to 200° C
 MX-50, MF-50, ML-50: 50° C to 200° C (1° increment)

Measurement Program Memories:

MS-70, MX50: 20 sets
 MF-50: 10 sets
 ML-50: 5 sets

Data Memory:

MS-70, MX-50: 100
 MF-50: 50
 ML-50: 30

Moisture Content Display:

MS-70: 0.001%/0.01%/0.1%
 MX-50: 0.01%/0.1%
 MF-50: 0.05%/0.1%/1%
 ML-50: 0.1%/1%

Moisture Content Accuracy Over 1 g:

MS-70: 0.05%
 MX-50: 0.10%
 MF-50: 0.20%
 ML-50: 0.50%

Over 5 g:

MS-70: 0.01%
 MX-50: 0.02%
 MF-50: 0.05%
 ML-50: 0.10%

Operating Temperature:

40° F to 104° F (5° C to 40° C)

Heating Technology:

Halogen lamp (straight type, 400-Watt max, 5,000 hours)

Est. Weight:

13 lb (5.9 kg)

Warranty:

Five-year limited

Return Policy:

A&D Weighing Standard Policy - restock fee may apply

Model	Capacity	Readability	Pan Size	Dimensions	Part #	List Price
MS-70	71 g	0.0001 g	85 mm (Ø 2.16 in)	215 × 320 × 173 mm (8.46 × 12.6 × 6.8 in)	97821	\$5,875.00
MX-50	51 g	0.001 g	85 mm (Ø 2.16 in)	215 × 320 × 173 mm (8.46 × 12.6 × 6.8 in)	97822	\$3,650.00
MF-50	51 g	0.002 g	85 mm (Ø 2.16 in)	215 × 320 × 173 mm (8.46 × 12.6 × 6.8 in)	97823	\$2,950.00
ML-50	51 g	0.005 g	85 mm (Ø 2.16 in)	215 × 320 × 173 mm (8.46 × 12.6 × 6.8 in)	112408	\$2,552.00

Options/Accessories

Part #	A&D Model #	Description	Price
97824	AX-31	Sample pans (washable, 100 each)	\$100.00
97825	AX-32-2	Glass fiber sheets (100 each)	\$55.00
97826	AX-33	Sodium tartrate dehydrate test samples (30 × 12 g)	\$88.00
97827	AX-34	Halogen lamp (replacement)	\$67.00
97828	AX-35	Pan handles (2 each)	\$29.00
97829	AX-36	Tweezers (2 each)	\$19.00
97830	AX-37	Spoons (2 each)	\$23.00
97831	AX-38	Protective in-use covers (5 each)	\$45.00
97832	AX-39	Dust cover	\$19.00
97833	AX-42	WinCT [®] Moisture (standard for MS-70 and MX-50, option for MF-50)	\$245.00
97834	AD-1700-20G	Calibration mass (20 g)	\$110.00
97837	AX-43	Temperature calibrator (MS-70 and MX-50 only)	\$465.00
151247	AD-1688	Data logger	\$320.00
196128	AD-8127	Impact dot matrix, statistical printer, includes cable	\$890.00



STATIC ELIMINATOR AD-1683

Standard Features

- Can be easily and safely installed; requires no high-voltage wiring
- Eliminates static charges from quickly running or highly electrified work pieces
- Little or no reverse charge is induced by irradiated ions because of its excellent ion polarity or the potential of the charged object
- Achieves static elimination with a huge degree of efficiency regardless of the polarity or the potential of the charged object
- Suited for static elimination in narrow and remote places because of its lengthy ion irradiation distance
- Produces only a little amount of ozone thanks to its high ion generation efficiency
- A current limiting circuit is incorporated in the ion generating electrode to reduce the possibility of electric shock
- No swing in surface potential of the charged object

Specifications

Power:

100 to 240 V AC, 50/60 Hz, 1.5 V AC

Elimination Range:

Distance: 10 to 30 cm from the electrode area: 30 × 30 cm

Static Elimination Method:

DC corona discharge DUAL-DC

Static Eliminating Electrode:

Tungsten emitter

Environmental Conditions:

-5 °C to 40 °C, 35% to 85%RH (non-condensing)

Est. Weight:

300 g

Power:

100 to 240 V AC, 50/60 Hz, 1.5 V AC

Warranty:

One-year limited

Model	Elimination Range	Static Elimination Method	Static Eliminating Electrode	Environmental Conditions	Weight	Part #	List Price
AD-1683	Distance: 10 cm to 30 cm from the electrode area: 30 cm × 30 cm	DC corona discharge DUAL-DC	Tungsten emitter	-5° C to 40° C, 35% to 85%RH (no condensation)	300 g	97610	\$1,275.00

(Below) Example of AD-1683 installation showing static elimination area and an example of ion generation.

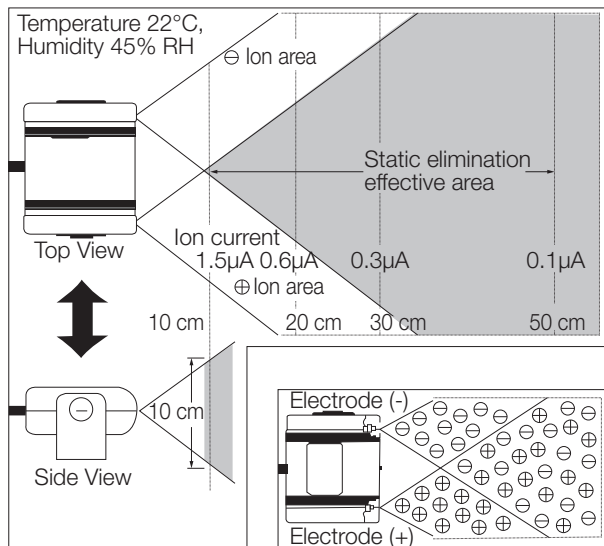

SEMI-MICRO EXPLORER® Series

Standard Features

- Intuitive SmartText™ software
- 4 programmable touchless sensors
- Weighing chamber
- Color touchscreen display
- Memory for up to 99 items
- Real-time clock for GLP/GMP data collection
- Audible stability alert
- Autocal automatic calibration
- EX225D/AD and EX225/AD
- Includes ionizer and auto doors

Specifications

Weighing Units:

Gram, Kilogram, Ounce, Pound, Carat, Pennyweight, Grain, Newton (See technical manual for complete listing)

Operating Modes:

Weighing, Percent Weighing, Parts Counting, Checkweighing, Dynamic/Animal Weighing, Filling, Totalization, Formulation, Differential Weighing, Density Determination, Peak Hold, Pipette Adjustment, SQC

Power Requirements:

AC adapter input: 100 to 240 VAC
0.6A 50 to 60 Hz

Stabilization Time:

0.1 mg = 0.3 seconds; 0.01 mg = 8 second

Min-Weight:

20.0 mg fine range (USP, u=0.10%, k=2)

Calibration:

AutoCal™ on 1.5° C temperature change, 11 hours, and external calibration

Operating Temperature Range:

14° F to 86 °F (-10° C to 30° C)

Est. Weight:

25 lb (12.5 kg)

Warranty:

Two-year limited

Return Policy:

OHAUS Standard Policy - restock fee may apply

Model	Capacity	Readability	Repeatability (20 g) std	Repeatability (100 g) std	Linearity	Pan Size	Dimensions	Part #	List Price
EX125D	52 g/120 g	0.01 mg/ 0.1 mg	±0.015 mg	0.1 mg	±0.1 mg	80 mm	9 × 15.4 × 13.8 in (230 × 393 × 350 mm)	171347	\$6,636.00
EX125	120 g	0.01 mg	±0.015 mg	0.02 mg	±0.1 mg	80 mm	9 × 15.4 × 13.8 in (230 × 393 × 350 mm)	171348	\$8,273.00
EX225D	120 g/220 g	0.01 mg/ 0.1 mg	±0.015 mg	0.02 mg/0.1 mg	±0.1 mg	80 mm	9 × 15.4 × 13.8 in (230 × 393 × 350 mm)	171349	\$8,464.00
EX225D/AD	120 g/220 g	0.01 mg/ 0.1 mg	±0.015 mg	0.02 mg/0.1 mg	±0.1 mg	80 mm	9 × 15.4 × 13.8 in (230 × 393 × 350 mm)	171350	\$8,745.00
EX225/AD	220 g	0.01 mg	±0.015 mg	0.03 mg	±0.1 mg	80 mm	9 × 15.4 × 13.8 in (230 × 393 × 350 mm)	171351	\$10,558.00

Options/Accessories

Part #	Model #	Description	Price
70406	80500525	RS-232 Cable, PC 9-Pin to EX	\$232.00
156234	46001724	Multi-range AC adapter	\$60.00
156235	46001780	International plug set	\$26.00



ANALYTICAL PIONEER® PX Series

Standard Features

- Easy-to-clean analytical draft shield
- Up-front level indicator
- Selectable environment settings
- Flexibility of available options
- Removable doors for easy cleaning and access
- Up-front level bubble for easy reference
- Selectable environmental settings
- Integral underweigh hook
- Standard security bracket
- RS-232 interface for connecting to printer or PC
- Security menu lock
- Backlight display

Specifications

Weighing Units:

Milligram, Gram, Carat, Ounce, Troy Ounce, Grain, Pennyweight, Momme, Ticals, Tola, Baht, Mesghal, Newton, Custom Unit

Operating Modes:

Weighing, Parts Counting, Percent, Density Determination, Dynamic Weighing

Power:

120 VAC adapter (220 to 240 VAC adapter by special order), 50/60 Hz

Stabilization Time Approx:

4 seconds
Calibration Weight
PX84/E: 50/80
PX124/E: 50/100
PX224/E: 100/200

Operating Temperature:

50 °F to 86 °F (10 °C to 30 °C)

Est. Weight:

10 lb (4.5kg)

Warranty:

Two-year limited

Return Policy:

OHAUS Standard Policy - restock fee may apply

Model	Capacity	Readability	Repeatability	Linearity	Weighing Chamber	Pan Size	Dimensions	Part #	List Price
PX84/E	82 g	0.1 mg	0.1 mg	0.2 mg	7.32 × 6.30 × 9.05 in (186 × 160 × 230 mm)	3.54 in (90 mm)	8.2 × 12.6 × 12.2 in (209 × 321 × 309 mm)	191850	\$1,994.00
PX124/E	120 g	0.1 mg	0.1 mg	0.2 mg	7.32 × 6.30 × 9.05 in (186 × 160 × 230 mm)	3.54 in (90 mm)	8.2 × 12.6 × 12.2 in (209 × 321 × 309 mm)	191851	\$2,300.00
PX224/E	220 g	0.1 mg	0.1 mg	0.2 mg	7.32 × 6.30 × 9.05 in (186 × 160 × 230 mm)	3.54 in (90 mm)	8.2 × 12.6 × 12.2 in (209 × 321 × 309 mm)	191852	\$2,553.00

Options/Accessories

Part #	A&D Model #	Description	Price
67413	80850080	TAL software WinWedge®	\$575.00
191875	80850043	Security device for Pioneer	\$279.00
102799	80780009	Forceps, 2.75 in (70 mm)	\$31.00
102800	80780010	Forceps, 3.5 in (89 mm)	\$31.00
33455	80850364	Aluminum scoop, 1.5 in × 2 in (3.8 cm × 5.1 cm), weight 4g	\$44.00
33454	80250048	Black scoop, aluminum 4 in × 3.5 in (10.2 cm × 8.9 cm), weight 24 g	\$45.00
33451	80850359	Polypropylene Maxi-Scoop™ 10 in dia. × 2.5 in deep (25.4 cm dia. × 6.4 cm deep) with pouring spout, weight 145 g	\$44.00
97250	80250400	Stainless steel scoop 11.9 in × 7.38 in × 1.69 in	\$89.00
100292	80250954	Stainless steel scoop 17.2 in × 11 in × 3.4 in (44 cm × 28 cm × 8.5 cm)	\$105.00
156234	46001724	AC adapter (requires 156235 plug set)	\$60.00
156235	46001780	Universal plug set	\$26.00
191876	30472064	Auxiliary display AD7-RS	\$87.00
191877	80253384	Density kit	\$936.00
191878	83034024	Sinker glass for density determination	\$786.00
191879	83021085	USB interface cable	\$232.00
191880	30093334	Dust cover	\$61.00
191881	30372546	In-use cover	\$56.00



Standard Features

- Automatic calibration via AutoCal™
- Communication RS-232C
- On-screen prompts
- Spill channel
- Applications library to store and quickly recall past procedures
- Brilliant backlit, high-resolution dot matrix display with simple navigation windows and menus to guide you through balance functions
- User-selectable GLP outputs via RS-232 to meet traceability requirements
- User-selectable filter, stability indicator and auto-zero tracking for use in difficult environments
- Five-language operation display text
- Standard underweigh capability
- Protective in-use cover and security bracket

OPTIONS:

- NTEP Certified, Legal for Trade models by special order

Specifications

Weighing Units

Milligram, Gram, Kilogram, Ounce, Carat, Pennyweight, Troy Ounce, Grain, Newton (See technical manual for complete listing)

Operating Modes

Weighing, Percent Weighing, Parts Counting, Checkweighing, Dynamic/Animal Weighing, Filling, Totalization, Formulation, Differential Weighing, Density Determination, Peak Hold, Ingredient Costing, Pipette Adjustment, SQC

Power Requirements

AC adapter input: 100-240 VAC 0.6A 50-60 Hz

Stabilization Time

EX124: ≤2 seconds
EX224: ≤2 seconds
EX324: ≤3 seconds

Calibration

AutoCal™ on Δ1.5° C temperature change, 11 hours, and external calibration

Operating Temperature Range

50° F to 86° F (10° C to 30° C)

Est. Weight

21.1 lb (9.6 kg)

Warranty

Two-year limited warranty

Return Policy

OHAUS Standard Policy - restock fee may apply

Model	Capacity	Readability	Repeatability	Linearity	Weighing Chamber	Pan Size	Dimensions	Part #	List Price
EX124	120 g	0.0001 g	±0.0001 g	±0.0002 g	9.5 × 7.5 × 6.5 in (241 × 190 × 165 mm)	Ø 3.5 in (90 mm)	9.1 × 15.5 × 13.8 in (230 × 393 × 350 mm)	121192	\$4,927.00
EX224	220 g	0.0001 g	±0.0001 g	±0.0002 g	9.5 × 7.5 × 6.5 in (241 × 190 × 165 mm)	Ø 3.5 in (90 mm)	9.1 × 15.5 × 13.8 in (230 × 393 × 350 mm)	121193	\$5,475.00
EX324	320 g	0.0001 g	±0.0001 g	±0.0002 g	9.5 × 7.5 × 6.5 in (241 × 190 × 165 mm)	Ø 3.5 in (90 mm)	9.1 × 15.5 × 13.8 in (230 × 393 × 350 mm)	121194	\$6,430.00

Options/Accessories

Part #	Model #	Description	Price
35263	80850043	Security device for EX	\$107.00
77712	80500524	RS-232 cable, PC 25-Pin to EX	\$232.00
70406	80500525	RS-232 Cable, PC 9-Pin to EX	\$232.00
156234	46001724	Multi-range AC adapter	\$60.00
156235	46001780	International plug set	\$26.00



ANALYTICAL ADVENTURER® Series

Standard Features

- Stable, accurate and fast operation, ensuring optimal weighing results
- Color touchscreen with 4.3 in (109 mm) display size
- Dual USB ports and RS-232 provide connectivity options
- Space-saving, top-mounted draft shield on analytical models
- Real time clock with GLP/GMP data
- Below minimum sample weight indication with minimum weight feature
- AutoCal™ automatic calibration

Specifications

Weighing Units:

Milligram, Gram, Kilogram, Ounce, Pound, Carat, Pennyweight, Troy Ounce, Grain, Newton (See technical manual for complete listing)

Operating Modes:

Counting, Weighing, Dynamic Weighing, Check-weighing, Percent Weighing, Totalization, Display Hold, Density Determination, Formulation

Power:

100 to 240 VAC, 0.3A, 50 to 60 HZ AC adapter

Calibration Weight:

AX124: 100 g
AX224: 224 g
AX324: 300 g

Operating Temperature:

50 °F to 86 °F (10 °C to 30 °C)

Est. Weight:

17.2 lb (7.8 kg)

Warranty:

Two-year limited

Model	Capacity	Readability	Repeatability	Linearity	Pan Size	Weighing Chamber	Dimensions	Part #	List Price
AX124	120 g	0.0001 g	1 mg	0.2 mg	3.5 in (90 mm)	9.05 × 13.92 × 13.39 in (230 × 354 × 340 mm)	13.93 × 13.39 × 9.05 in (354 × 340 × 230 mm)	164622	\$3,598.00
AX224	220 g	0.0001 g	1 mg	0.2 mg	3.5 in (90 mm)	9.05 × 13.92 × 13.39 in (230 × 354 × 340 mm)	13.93 × 13.39 × 9.05 in (354 × 340 × 230 mm)	164623	\$3,972.00
AX324	320 g	0.0001 g	1 mg	0.2 mg	3.5 in (90 mm)	9.05 × 13.92 × 13.39 in (230 × 354 × 340 mm)	13.93 × 13.39 × 9.05 in (354 × 340 × 230 mm)	164625	\$4,341.00

Options/Accessories

Part #	Model #	Description	Price
191879	83021085	USB cable, Type A to B	\$232.00
191875	80850043	Security device (laptop lock)	\$279.00
77712	80500524	25-pin RS-232 cable (PC)	\$232.00
70406	80500525	9-pin RS-232 cable (PC)	\$232.00



Standard Features

- Automatic Zero Tracking (AZT)
- Integral LCD display
- Auto-off feature
- Programmable tare
- Transportation lock
- Menu/calibration lockout switch

Specifications

Weighing Units

Gram, Kilogram, Ounce, Pound, Carat, Pennyweight, Troy Ounce, Grain, Pound/Ounce

Operating Modes

Weighing, Parts Counting, Percent Weighing, Checkweighing, Totalization, Density Determination, Display Hold

Power

AC adapter (included) or four AA batteries (not included)

Typical Battery Life

80 hours

Verification Interval

SJX323N/E – 0.01 g
 SJX622N/E and SJX1502N/E – 0.1 g
 SJX6201N/E – 1 g

Draft shield

SJX323N/E – Yes
 SJX622N/E, SJX1502N/E, SJX6201N/E – No

Class

SJX323N/E and SJX1502N/E – II
 SJX622N/E and SJX6201N/E – III

Calibration Weight

SJX323N/E: 50 g
 SJX622N/E: 300 g
 SJX1502M/E: 1.5 kg
 SJX6201N/E: 5 kg

Operating Temperature

Class II: 10° C to 30° C (0° F to 86° F) at 10% to 80% relative humidity, no condensation
 Class III: 10° C to 40° C (50° F to 104° F) at 10% to 80% relative humidity, no condensation

Est. Weight

3.3 lb (1.5 kg)

Warranty

Two-year limited warranty

Approvals

NTEP CC: 16-015
 Measurement Canada: AM-6008



Model	Capacity	Readability	Repeatability	Pan Size	Dimensions	Part #	List Price
SJX323N/E	64 g	0.001 g	0.002 g	Ø 3.7 in (Ø 93 mm)	8 × 8.7 × 4.1 in (202 × 222 × 103 mm)	196652	\$812.00
SJX622N/E	620 g	0.1 g	0.01 g	Ø 4.7 in (Ø 120 mm)	8 × 8.7 × 4.1 in (202 × 222 × 103 mm)	196653	\$1,018.00
SJX1502N/E	1,500 g	0.01 g	0.02 g	6.7 × 5.5 in (170 × 140 mm)	8 × 8.7 × 4.1 in (202 × 222 × 103 mm)	196654	\$1,182.00
SJX6201N/E	6,200 g	1 g	0.1 g	6.7 × 5.5 in (170 × 140 mm)	8 × 8.7 × 4.1 in (202 × 222 × 103 mm)	196655	\$1,044.00



SJX323N/E



SJX622N/E



SJX1502N/E and SJX6201N/E

LEGAL FOR TRADE

VALOR[®] 7000 Series

Standard Features

- Touchless sensors
- Backlit dual LCD display
- Illuminated up-front level indicator
- Internal rechargeable battery
- ABS plastic housing
- Skid-resistant leveling feet
- Menu lock switch
- Multiple application modes
- RS-232 interface for connecting to printer or PC
- Fast stabilizing time

Specifications

Weighing Units:

Pound, Ounce, Kilogram, Gram

Operating Modes:

Weighing, Percent, Checkweighing, Accumulation

Power:

100 to 240 V, internal rechargeable battery 210 hour operation with 12 hour full charge

Stabilization Time:

= 1 second

NTEP Resolution:

V71P1502T: 3 × 0.001 lb

V71P3T: 6 × 0.002 lb

V71P6T: 15 × 0.005 lb

V71P15T: 30 × 0.01 lb

V71P30T: 60 × 0.02 lb

Operating Temperature:

14 °F to 104 °F (-10 °C to 40 °C)

Calibration Weight:

1502T: 1.5kg / 3lb

3T: 3kg / 6lb

6T: 6kg / 15lb

15T: 15kg / 30lb

30T: 30kg / 60lb

Est. Weight:

9.2 lb (4.2 kg)

Warranty:

One-year limited

Return Policy:

OHAUS standard policy - restock fee may apply

Approvals:

NTEP: CC 13-022

Measurement Canada: AM-5907C

OIML: R76/2006-NL1-12-46

NSF



Model	Capacity	Readability	Pan Size	Dimensions	Part #	List Price
V71P1502T	1.5 kg	0.00005 kg	11.8 × 8.9 in (300 × 225 mm)	12.2 × 12.9 × 4.6 in (311 × 327 × 117 mm)	157316	\$821.00
V71P3T	3 kg	0.0001 kg	11.8 × 8.9 in (300 × 225 mm)	12.2 × 12.9 × 4.6 in (311 × 327 × 117 mm)	157317	\$821.00
V71P6T	6 kg	0.0002 kg	11.8 × 8.9 in (300 × 225 mm)	12.2 × 12.9 × 4.6 in (311 × 327 × 117 mm)	157318	\$821.00
V71P15T	15 kg	0.0005 kg	11.8 × 8.9 in (300 × 225 mm)	12.2 × 12.9 × 4.6 in (311 × 327 × 117 mm)	157319	\$821.00
V71P30T	30 kg	0.001 kg	11.8 × 8.9 in (300 × 225 mm)	12.2 × 12.9 × 4.6 in (311 × 327 × 117 mm)	157320	\$821.00

Options/Accessories

Part #	Model #	Description	Price
154638	30037447	Ethernet kit	\$168.00



Standard Features

- Stable, accurate and fast operation, ensuring optimal weighing results
- Color touchscreen with 4.3 in (109 mm) display size
- Dual USB ports and RS-232 provide connectivity options
- Space-saving, top-mounted draft shield on analytical models
- Real time clock with GLP/GMP data
- Below minimum sample weight indication with minimum weight feature
- AutoCal™

Specifications

Weighing Units

Milligram, Gram, Kilogram, Ounce, Pound, Carat, Pennyweight, Troy Ounce, Grain, Newton, Hong Kong Tael, Singapore Tael, Taiwan Tael, Momme, Tical, Baht, Mesghal, Tola, Custom

Operating Modes

Counting, Weighing, Dynamic Weighing, Check-weighing, Percent Weighing, Totalization, Display Hold, Density Determination, Formulation

Power

100 - 240 VAC, 0.3A, 50-60 HZ AC adapter

Class

AX224N: I (0.001 g)
 AX223N/E: II (0.01g)
 AX423N/E and AX523N/E: II (0.01 g)
 AX622N/E, AX1502N/E, AX2202N/E,
 AX4202N/E: II (0.1 g)
 AX8201N/E: II (1 g)

Operating Temperature

10° C to 30° C (50° F to 86° F)

Calibration Weight

224N , AX223 and AX223N/E: 200 g
 AX423: 400 g
 AX523: 500 g
 AX622: 600 g
 1502N/E: 1500g
 2202N/E: 2000g
 4202N/E: 4000g
 8201N/E: 8000g

Est. Weight

AX224N: 17.2 lb (7.8 kg)
 AX223N/E: 12.8 lb (5.8 kg)
 AX423N/E and AX523N/E: 12.8 lb (5.8 kg)
 AX622N/E, AX1502N/E, AX2202N/E,
 AX4202N/E: 14.4 lb (6.5 kg)
 AX8201N/E: 12.6 lb (5.7 kg)

Warranty

Two-year limited warranty

Return Policy

OHAUS Standard Policy - restock fee may apply

Approvals

NTEP CC: 14-082
 Measurement Canada: AM-5957



Model	Capacity	Readability	Repeatability	Linearity	Pan Size	Dimensions	Part #	List Price
NTEP Certified and Measurement Canada Approved								
AX224N	220 g	0.0001 g	2 mg	0.2 mg	3.5 in (90 mm)	13.93 × 13.39 × 9.05 in (354 × 340 × 230 mm)	164624	\$4,215.00
AX223N/E	220 g	0.001 g	0.001 g	0.2 mg	5.1 in (130 mm)	13.93 × 13.39 × 9.05 in (354 × 340 × 230 mm)	164627	\$1,915.00
AX423N/E	420 g	0.001 g	0.001 g	0.002 mg	5.1 in (130 mm)	13.93 × 13.39 × 9.05 in (354 × 340 × 230 mm)	164629	\$2,284.00
AX523N/E	520 g	0.001 g	0.001 g	0.002 mg	5.1 in (130 mm)	13.93 × 13.39 × 9.05 in (354 × 340 × 230 mm)	164632	\$2,537.00
AX622N/E	620 g	0.01 g	0.001 g	0.002 mg	6.9 × 7.7 in (175 × 195 mm)	13.93 × 3.94 × 9.05 in (354 × 100 × 230 mm)	164634	\$1,482.00
AX1502N/E	1,520 g	0.01 g	0.001 g	0.002 mg	6.9 × 7.7 in (175 × 195 mm)	13.93 × 3.94 × 9.05 in (354 × 100 × 230 mm)	164636	\$1,672.00
AX2202N/E	2,200 g	0.01 g	0.01 g	0.002 mg	6.9 × 7.7 in (175 × 195 mm)	13.93 × 3.94 × 9.05 in (354 × 100 × 230 mm)	164638	\$1,857.00
AX4202N/E	4,200 g	0.01 g	0.01 g	0.002 mg	6.9 × 7.7 in (175 × 195 mm)	13.93 × 3.94 × 9.05 in (354 × 100 × 230 mm)	164640	\$2,353.00
AX8201N/E	8,200 g	0.1 g	0.1 g	0.02 mg	6.9 × 7.7 in (175 × 195 mm)	13.93 × 3.94 × 9.05 in (354 × 100 × 230 mm)	164644	\$1,857.00

Options/Accessories

Part #	Model #	Description	Price
191879	83021085	USB cable, Type A to B	\$232.00
191875	80850043	Security device (laptop lock)	\$279.00
77712	80500524	25-pin RS-232 cable (PC)	\$232.00
70406	80500525	9-pin RS-232 cable (PC)	\$232.00



PRECISION

ADVENTURER® Series

Standard Features

- Stable, accurate and fast operation, ensuring optimal weighing results
- Color touchscreen with 4.3 in (109 mm) display size
- Dual USB ports and RS-232 provide connectivity options
- Space-saving, top-mounted draft shield on analytical models
- Real time clock with GLP/GMP data
- Below minimum sample weight indication with minimum weight feature
- AutoCal™ automatic internal calibration for optimized weighing performance

Specifications

Weighing Units:

Milligram, Gram, Kilogram, Ounce, Pound, Carat, Pennyweight, Troy Ounce, Grain, Newton, Hong Kong Tael, Singapore Tael, Taiwan Tael, Momme, Tical, Baht, Mesghal, Tola, Custom

Operating Modes:

Counting, Weighing, Dynamic Weighing, Check-weighing, Percent Weighing, Totalization, Display Hold, Density Determination, Formulation

Power:

100 to 240 VAC, 0.3A, 50 to 60 HZ AC adapter

Stabilization Time:

= 1 second

Calibration Weight:

AX223: 200 g
AX423: 400 g
AX523: 500 g
AX622: 600 g

Operating Temperature:

10 °C to 30 °C (50 °F to 86 °F)

Est. Weight:

AX223, AX423, AX523: 12.8 lb (5.8 kg)

Warranty:

Two-year limited

Return Policy:

OHAUS standard policy - restock fee may apply

Model	Capacity	Readability	Repeatability	Linearity	Pan Size	Dimensions	Part #	List Price
AX223	220 g	0.001 g	0.001 g	0.2 mg	5.1 in (130 mm)	13.93 × 13.39 × 9.05 in (354 × 340 × 230 mm)	164626	\$2,179.00
AX423	420 g	0.001 g	0.001 g	0.002 mg	5.1 in (130 mm)	13.93 × 13.39 × 9.05 in (354 × 340 × 230 mm)	164628	\$2,627.00
AX523	520 g	0.001 g	0.001 g	0.002 mg	5.1 in (130 mm)	13.93 × 13.39 × 9.05 in (354 × 340 × 230 mm)	164630	\$2,870.00
AX622	620 g	0.01 g	0.001 g	0.002 mg	6.9 x 7.7 in (175 × 195 mm)	13.93 × 3.94 × 9.05 in (354 × 100 × 230 mm)	164633	\$1,651.00

Options/Accessories

Part #	Model #	Description	Price
191879	83021085	USB cable, Type A to B	\$232.00
191875	80850043	Security device (laptop lock)	\$279.00
77712	80500524	25-pin RS-232 cable (PC)	\$232.00
70406	80500525	9-pin RS-232 cable (PC)	\$232.00



PRECISION
PIONEER® PX Series

Standard Features

- Easy-to-clean analytical draft shield (select models)
- Up-front level indicator
- Selectable environment settings
- Flexibility of available options
- Removable doors for easy cleaning and access
- Up-front level bubble for easy reference
- Selectable environmental settings
- Integral underweigh hook
- Standard security bracket
- RS-232 interface for connecting to printer or PC
- Security menu lock
- Backlight display

Specifications

Weighing Units:

Milligram, Gram, Carat, Ounce, Troy Ounce, Grain, Pennyweight, Momme, Tael, Tola, Baht, Mesghal, Newton, Custom Unit

Operating Modes:

Weighing, Parts Counting, Percent, Density, Determination, Dynamic Weighing

Power:

120 VAC adapter (220 to 240 VAC adapter by special order), 50/60 Hz

Stabilization Time:

Approx. 4 seconds

Calibration Weight:

PX163/E: 100/150 g
 PX323/E: 200/300 g
 PX523/E: 200/500 g

Operating Temperature:

10°C to 30°C (50°F to 86°F)

Est. Weight:

10 lb (4.5kg)

Warranty:

Two-year limited

Return Policy:

OHAUS Standard Policy - restock fee may apply

Model	Capacity	Readability	Repeatability	Linearity	Pan Size	Dimensions	Part #	List Price
PX163/E	160 g	0.001 g	1 mg	2 mg	4.72 in (120 mm)	8.2 × 12.6 × 12.2 in (209 × 321 × 309 mm)	191853	\$1,161.00
PX323/E	320 g	0.001 g	1 mg	2 mg	4.72 in (120 mm)	8.2 × 12.6 × 12.2 in (209 × 321 × 309 mm)	191854	\$1,350.00
PX523/E	520 g	0.001 g	1 mg	2 mg	4.72 in (120 mm)	8.2 × 12.6 × 12.2 in (209 × 321 × 309 mm)	191855	\$1,709.00

Options/Accessories

Part #	A&D Model #	Description	Price
67413	80850080	TAL software WinWedge®	\$575.00
191875	80850043	Security device for Pioneer	\$279.00
102799	80780009	Forceps, 2.75 in (70 mm)	\$31.00
102800	80780010	Forceps, 3.5 in (89 mm)	\$31.00
33455	80850364	Aluminum scoop, 1.5 in × 2 in (3.8 cm × 5.1 cm), weight 4g	\$44.00
33454	80250048	Black scoop, aluminum 4 in × 3.5 ft (10.2 cm × 8.9 cm), weight 24g	\$45.00
33451	80850359	Polypropylene Maxi-Scoop™ 10 in dia. × 2.5 in deep (25.4 cm dia. × 6.4 cm deep) with pouring spout, weight 145 g	\$44.00
97250	80250400	Stainless steel scoop 11.9 in × 7.38 in × 1.69 in	\$89.00
100292	80250954	Stainless steel scoop 17.2 in × 11 in × 3.4 in (44 cm × 28 cm × 8.5 cm)	\$105.00
156234	46001724	AC adapter (requires 156235 plug set)	\$60.00
156235	46001780	Universal plug set	\$26.00
191876	30472064	Auxiliary display AD7-RS	\$87.00
191877	80253384	Density kit	\$936.00
191878	83034024	Sinker glass for density determination	\$786.00
191879	83021085	USB interface cable	\$232.00
191880	30093334	Dust cover	\$61.00
191881	30372546	In-use cover	\$56.00



PRECISION

EXPLORER® Series

Standard Features

- Capacities from 220 g to 10.2 kg with Readability to 0.001 g
- Large, 5.7 full-color touchscreen display with intuitive setup and application software
- AutoCal™ automatic internal calibration for optimized weighing performance
- 14 application modes, 11 weighing units and 5 display languages for a wide variety of applications
- Four programmable touchless sensors for hands-free operation
- 0.001 g models feature frameless draftshield with anti-static glass, flip-top and large side entry doors on top-mounted bearings

OPTIONS

- External calibration models available upon request

Specifications

Weighing Units:

Milligram, Gram, Kilogram, Ounce, Carat, Pennyweight, Troy Ounce, Grain, Newton (See technical manual for complete listing)

Operating Modes:

Weighing, Percent Weighing, Parts Counting, Checkweighing, Dynamic/Animal Weighing, Filling, Totalization, Formulation, Differential Weighing, Density Determination, Peak Hold, Ingredient Costing, Pipette Adjustment, SQC

Power Requirements:

AC adapter input: 100 to 240 VAC 0.6A 50 to 60 Hz

Stabilization Time:

= 1.5 second

Calibration:

AutoCal™ on $\pm 1.5^\circ\text{C}$ temperature change, 11 hours, and external calibration

Operating Temperature:

10°C to 30°C (50°F to 86°F)

Est. Weight:

21.1 lb (9.6 kg)

Warranty:

Two-year limited

Return Policy:

OHAUS standard policy - restock fee may apply

Model	Capacity	Readability	Repeatability	Linearity	Weighing Chamber	Pan Size	Dimensions	Part #	List Price
EX223	220 g	0.001 g	± 0.001 g	± 0.002 g	9.5 × 7.5 × 6.5 in	Ø 5.1 in (130 mm)	9.1 × 15.5 × 13.8 in (230 × 393 × 350 mm)	121195	\$3,234.00
EX423	420 g	0.001 g	± 0.001 g	± 0.002 g	9.5 × 7.5 × 6.5 in	Ø 5.1 in (130 mm)	9.1 × 15.5 × 13.8 in (230 × 393 × 350 mm)	121196	\$3,782.00
EX623	620 g	0.001 g	± 0.001 g	± 0.002 g	9.5 × 7.5 × 6.5 in	Ø 5.1 in (130 mm)	9.1 × 15.5 × 13.8 in (230 × 393 × 350 mm)	121197	\$4,621.00
EX1103	1,100 g	0.001 g	± 0.001 g	± 0.002 g	9.5 × 7.5 × 6.5 in	Ø 5.1 in (130 mm)	9.1 × 15.5 × 13.8 in (230 × 393 × 350 mm)	121198	\$5,417.00

Options/Accessories

Part #	Model #	Description	Price
35263	80850043	Security device for EX	\$107.00
77712	80500524	RS-232 cable, PC 25-Pin to EX	\$232.00
70406	80500525	RS-232 Cable, PC 9-Pin to EX	\$232.00
156234	46001724	Multi-range AC adapter	\$60.00
156235	46001780	International plug set	\$26.00



Standard Features

- ABS housing and stainless steel pan
- Display type (SPX): backlit LCD, six-digit, seven-segment with white LED backlight
- Display type (STX): full-color touchscreen WQVGA graphic LCD

Specifications

Weighing Units

Gram, Kilogram, Ounce, Pound, Carat, Pennyweight, Troy Ounce, Grain, Newton, Pound/Ounce (See technical manual for complete listing)

Operating Modes

Weighing, Parts Counting, Percent Weighing, Checkweighing, Totalization, Display Hold, Only available on STX models: Animal/Dynamic Weighing, Density Determination, Mole Weighing

Power

Multi-range, multi-plug AC power or battery (uses 4-AA batteries not included)

Stabilization Time

1 second

Typical Battery Life

SPX123, SPX223, SPX422, SPX622, SPX1202, SPX2202, SPX6201: 80 hours
SPX222, SPX421, SPX621, SPX2201, SPX8200: 120 hours

Calibration Weight

SPX123 and STX123: 100 g
SPX223, STX223: 200 g

Operating Temperature

10° C to 40° C (50° F to 104° F);
10% to 85% at 31° C, decreasing linearly to 50% at 40° C (no condensation)

Est. Weight

2.8 lb (1.24 kg)

Warranty

One-year limited warranty

Return Policy

OHAUS standard policy - restock fee may apply

Model	Capacity	Readability	Repeatability	Linearity	Pan Size	Dimensions	Part #	List Price
LCD Model								
SPX123	120 g	0.001 g	2d	0.003 g	Ø 3.7 in (93 mm)	8 × 8.7 × 4.1 in (202 × 222 × 103 mm)	171984	\$812.00
SPX223	220 g	0.001 g	2d	0.001 g	Ø 3.7 in (93 mm)	8 × 8.7 × 4.1 in (202 × 222 × 103 mm)	171985	\$907.00
Touchscreen Model								
STX123	120 g	0.001 g	2d	0.003 g	Ø 3.7 in (93 mm)	8 × 8.7 × 4.1 in (202 × 222 × 103 mm)	171996	\$923.00
STX223	220 g	0.001 g	2d	0.001 g	Ø 3.7 in (93 mm)	8 × 8.7 × 4.1 in (202 × 222 × 103 mm)	171998	\$1,034.00

Options/Accessories

Part #	Model #	Description	Price
67413	80850080	WinWedge® TAL Software	\$575.00
181878	30330714	Power supply, US plug, 110/220 VAC	\$31.00



SPX Round Pan



STX Rectangular Pan

TOPLOADER

PIONEER® PX Series

Standard Features

- Up-front level indicator
- Selectable environment settings
- Flexibility of available options
- Up-front level bubble for easy reference
- Selectable environmental settings
- Integral underweigh hook
- Standard security bracket
- RS-232 interface for connecting to printer or PC
- Security menu lock
- Backlight display

Specifications

Weighing Units

Milligram, Gram, Carat, Ounce, Troy Ounce, Grain, Pennyweight, Momme, Taels, Tical, Tola, Baht, Mesghal, Newton, Custom Unit

Operating Modes

Weighing, Parts Counting, Percent, Density Determination, Dynamic Weighing

Power

120 VAC adapter (220-240 VAC adapter by special order), 50/60 Hz

Stabilization Time

160 g - 520 g: 2 seconds
1,600 g - 4,200 g: One second

Operating Temperature

50°F to 86°F (10°C to 30°C)

Calibration Weight

PX1602/E: 1,000/1,500 g
PX2202/E: 1,000/2,000 g
PX3202/E: 2,000/3,000 g
PX4202/E: 2,000/4,000 g
PX2201/E: 1,000/2,000 g
PX4201/E: 2,000/4,000 g

Est. Weight

160 g - 520 g: 10 lb (4.5 kg)
1,600 g - 4,200 g: 7.7 lb (3.5 kg)

Warranty

Two-year limited warranty

Return Policy

OHAUS Standard Policy - restock fee may apply

Model	Capacity	Readability	Repeatability	Linearity	Pan Size	Dimensions	Part #	List Price
PX1602/E	1,600 g	0.01 g	10 mg	20 mg	7.1 in (180 mm)	8.2 × 12.6 × 3.9 in (209 × 321 × 98 mm)	191856	\$1,118.00
PX2202/E	2,200 g	0.01 g	10 mg	20 mg	7.1 in (180 mm)	8.2 × 12.6 × 3.9 in (209 × 321 × 98 mm)	191857	\$1,224.00
PX3202/E	3,200 g	0.01 g	10 mg	20 mg	7.1 in (180 mm)	8.2 × 12.6 × 3.9 in (209 × 321 × 98 mm)	191858	\$1,472.00
PX4202/E	4,200 g	0.01 g	10 mg	20 mg	7.1 in (180 mm)	8.2 × 12.6 × 3.9 in (209 × 321 × 98 mm)	191859	\$1,672.00
PX2201/E	2,200 g	0.1 g	100 mg	200 mg	7.1 in (180 mm)	8.2 × 12.6 × 3.9 in (209 × 321 × 98 mm)	191860	\$1,039.00
PX4201/E	4,200 g	0.1 g	100 mg	200 mg	7.1 in (180 mm)	8.2 × 12.6 × 3.9 in (209 × 321 × 98 mm)	191861	\$1,197.00

Options/Accessories

Part #	Model #	Description	Price
67413	80850080	TAL software WinWedge®	\$575.00
191875	80850043	Security device for Pioneer	\$279.00
102799	80780009	Forceps, 2.75 in (70 mm)	\$31.00
102800	80780010	Forceps, 3.5 in (89 mm)	\$31.00
33455	80850364	Aluminum scoop, 1.5 in × 2 in (3.8 cm × 5.1 cm), weight 4 g	\$44.00
33454	80250048	Black scoop, aluminum 4 in × 3.5 in (10.2 cm × 8.9 cm), weight 24 g	\$45.00
33451	80850359	Polypropylene Maxi-Scoop™ 10 in dia. × 2.5 in deep (25.4 cm dia. × 6.4 cm deep) with pouring spout, weight 145 g	\$44.00
97250	80250400	Stainless steel scoop 11.9 in × 7.38 in × 1.69 in	\$89.00
100292	80250954	Stainless steel scoop 17.2 in × 11 in × 3.4 in (44 cm × 28 cm × 8.5 cm)	\$105.00
156234	46001724	AC adapter (requires 156235 plug set)	\$60.00
156235	46001780	Universal plug set	\$26.00
191876	30472064	Auxiliary display AD7-RS	\$87.00
191877	80253384	Density kit	\$936.00
191878	83034024	Sinker glass for density determination	\$786.00
191879	83021085	USB interface cable	\$232.00
191880	30093334	Dust cover	\$61.00
191881	30372546	In-use cover	\$56.00



TOPLOADER EXPLORER® Series

Standard Features

- Large, 5.7 full-color touchscreen display with intuitive set up and application software
- AutoCal™ automatic internal calibration for optimized weighing performance
- 14 application modes, 11 weighing units and 5 display languages for a wide variety of applications
- Four programmable touchless sensors for hands-free operation

OPTIONS

- External calibration models available upon request

Specifications

Weighing Units

Milligram, Gram, Kilogram, Ounce, Carat, Pennyweight, Troy Ounce, Grain, Newton (See technical manual for complete listing)

Operating Modes

Weighing, Percent Weighing, Parts Counting, Checkweighing, Dynamic/Animal Weighing, Filling, Totalization, Formulation, Differential Weighing, Density Determination, Peak Hold, Ingredient Costing, Pipette Adjustment, SQC

Power Requirements

AC adapter input: 100-240 VAC 0.6A 50-60 Hz

Stabilization Time

EX2202, EX4202, EX6202, EX10202, EX6201, EX10201: ≤1 seconds

Calibration

AutoCal™ on Δ1.5° C temperature change, 11 hours, and external calibration

Operating Temperature Range

10° C to 30° C (50° F to 86° F)

Est. Weight

EX2202, EX4202: 15 lb (6.8 kg)
EX6202, EX10202, EX6201, EX10201: 16.3 lb (7.4 kg)

Warranty

Two-year limited warranty

Return Policy

OHAUS Standard Policy - restock fee may apply

Model	Capacity	Readability	Repeatability	Linearity	Pan Size	Dimensions	Part #	List Price
EX2202	2,200 g	0.01 g	±0.01 g	±0.02 g	7.5 × 7.9 in (190 × 200 mm)	9.1 × 15.5 × 3.9 in (230 × 393 × 98 mm)	121199	\$3,497.00
EX4202	4,200 g	0.01 g	±0.01 g	±0.02 g	7.5 × 7.9 in (190 × 200 mm)	9.1 × 15.5 × 3.9 in (230 × 393 × 98 mm)	121200	\$4,020.00
EX6202	6,200 g	0.01 g	±0.01 g	±0.02 g	7.5 × 7.9 in (190 × 200 mm)	9.1 × 15.5 × 3.9 in (230 × 393 × 98 mm)	121201	\$4,563.00
EX10202	10,200 g	0.01 g	±0.01 g	±0.02 g	7.5 × 7.9 in (190 × 200 mm)	9.1 × 15.5 × 3.9 in (230 × 393 × 98 mm)	121202	\$5,412.00
EX6201	6,200 g	0.1 g	±0.1 g	±0.1 g	7.5 × 7.9 in (190 × 200 mm)	9.1 × 15.5 × 3.9 in (230 × 393 × 98 mm)	121203	\$3,793.00
EX10201	10,200 g	0.1 g	±0.1 g	±0.1 g	7.5 × 7.9 in (190 × 200 mm)	9.1 × 15.5 × 3.9 in (230 × 393 × 98 mm)	121204	\$4,157.00

Options/Accessories

Part #	Model #	Description	Price
35263	80850043	Security device for EX	\$107.00
77712	80500524	RS-232 cable, PC 25-Pin to EX	\$232.00
70406	80500525	RS-232 Cable, PC 9-Pin to EX	\$232.00
156234	46001724	Multi-range AC adapter	\$60.00
156235	46001780	International plug set	\$26.00



TOPLOADER

ADVENTURER® Series

Standard Features

- AutoCal™ automatic internal calibration for optimized weighing performance
- Stable, accurate and fast operation, ensuring optimal weighing results
- Color touchscreen with 4.3 in (109 mm) display size
- Dual USB ports and RS-232 provide connectivity options
- Real time clock with GLP/GMP data
- Below minimum sample weight indication with minimum weight feature

Specifications

Weighing Units

Milligram, Gram, Kilogram, Ounce, Pound, Carat, Pennyweight, Troy Ounce, Grain, Newton (See technical manual for complete listing)

Operating Modes

Counting, Weighing, Dynamic Weighing, Check-weighing, Percent Weighing, Totalization, Display Hold, Density Determination, Formulation

Power

100 - 240 VAC, 0.3A, 50-60 HZ AC adapter

Est. Weight

AX1502, AX2202, AX4202: 14.4 lb (6.5 kg)
AX8201, AX5202: 12.6 lb (5.7 kg)

Operating Temperature

10° C to 30° C (50° F to 86° F)

Warranty

Two-year limited warranty

Return Policy

OHAUS Standard Policy - restock fee may apply

Model	Capacity	Readability	Repeatability	Linearity	Pan Size	Dimensions	Part #	List Price
AX1502	1,520 g	0.01 g	0.001 g	0.002 mg	6.9 × 7.7 in (175 × 195 mm)	13.93 × 3.94 × 9.05 in (354 × 100 × 230 mm)	164635	\$2,015.00
AX2202	2,200 g	0.01 g	0.01 g	0.002 mg	6.9 × 7.7 in (175 × 195 mm)	13.93 × 3.94 × 9.05 in (354 × 100 × 230 mm)	164637	\$2,147.00
AX4202	4,200 g	0.01 g	0.01 g	0.002 mg	6.9 × 7.7 in (175 × 195 mm)	13.93 × 3.94 × 9.05 in (354 × 100 × 230 mm)	164639	\$2,696.00
AX5202	5,200 g	0.01 g	0.01 g	0.002 mg	6.9 × 7.7 in (175 × 195 mm)	13.93 × 3.94 × 9.05 in (354 × 100 × 230 mm)	164641	\$3,054.00
AX4201	4,200 g	0.1 g	0.1 g	0.02 mg	6.9 × 7.7 in (175 × 195 mm)	13.93 × 3.94 × 9.05 in (354 × 100 × 230 mm)	164642	\$1,778.00
AX8201	8,200 g	0.1 g	0.1 g	0.02 mg	6.9 × 7.7 in (175 × 195 mm)	13.93 × 3.94 × 9.05 in (354 × 100 × 230 mm)	164643	\$2,078.00

Options/Accessories

Part #	Model #	Description	Price
191879	83021085	USB cable, Type A to B	\$232.00
191875	80850043	Security device (laptop lock)	\$279.00
77712	80500524	25-pin RS-232 cable (PC)	\$232.00
70406	80500525	9-pin RS-232 cable (PC)	\$232.00



TOPLOADER NAVIGATOR™ XT Series

Standard Features

- Touchless IR (infrared) sensors minimize keypad use
- Program IR sensor to control zero, print tare, backlight and power functions
- Backlit 0.8 in LCD display for high visibility
- Illuminated level indicator at start-up
- Integrated transportation and calibration lock switch
- Hygienic design for easy cleanup in food, laboratory and industrial applications
- Impact-resistant ABS plastic housing with polished stainless steel spill-resistant pan
- Non-skid leveling feet

Specifications

Weighing Units

Gram, Carat, Ounce, Pound, Carat, Pennyweight, Troy Ounce, Grain, Pound/Ounce, (See technical manual for complete listing)

Operating Modes

Weighing, Percent, Parts Counting, Checkweighing, Display Hold, Accumulation/Totalization

Power

12 VDC 0.42 A AC adapter, 100-240 V, four C-batteries (not included)

Stabilization Time

1 second (NVT4201=1.5 seconds)

Ext. Cal. Mass (optional)

NVT2201: 2 lb (1 kg)
NVT4201: 5 lb (2 kg)
NVT6200: 10 lb (5 kg)
NVT12000: 10 lb (5 kg)
NVT2200: 20 lb (10 kg)

Operating Temperature

10° C to 40° C (50° F to 104° F) at 20%-85% RH

Est. Weight

5.1 lb (2.3 kg)

Warranty

One-year limited warranty

Return Policy

OHAUS Standard Policy - restock fee may apply

Model	Capacity	Readability	Linearity	Pan Size	Dimensions	Part #	List Price
NVT2201	2,200 g	0.1 g	0.1 g/±0.2 g	9.1 × 6.9 in (230 × 174 mm)	9.5 × 9.8 × 2.9 in (240 × 250 × 74 mm)	194607	\$460.00
NVT4201	4,200 g	0.1 g	0.1 g/±0.2 g	9.1 × 6.9 in (230 × 174 mm)	9.5 × 9.8 × 2.9 in (240 × 250 × 74 mm)	194608	\$575.00
NVT6200	6,200 g	1 g	1 g/±2 g	9.1 × 6.9 in (230 × 174 mm)	9.5 × 9.8 × 2.9 in (240 × 250 × 74 mm)	194609	\$575.00
NVT12000	12,000 g	1 g	1 g/±2 g	9.1 × 6.9 in (230 × 174 mm)	9.5 × 9.8 × 2.9 in (240 × 250 × 74 mm)	194610	\$622.00
NVT22000	22,000 g	1 g	1 g/±2 g	9.1 × 6.9 in (230 × 174 mm)	9.5 × 9.8 × 2.9 in (240 × 250 × 74 mm)	194611	\$744.00

Options/Accessories

Part #	Model #	Description	Price
118779	83032107	RS-232 interface kit, Navigator series	\$201.00
118780	83032108	USB interface kit	\$201.00
118781	83032109	Ethernet interface kit	\$201.00
194616	30467963	Carrying case	\$132.00
194615	30467987	Universal AC adapter	\$47.00



TOPLOADER SCOUT® Series

Standard Features

- ABS housing and stainless steel pan
- Display type (SPX): backlit LCD, six-digit, seven-segment with white LED backlight
- Display type (STX): full-color touchscreen WQVGA graphic LCD

Specifications

Weighing Units

Gram, Kilogram, Ounce, Pound, Carat, Pennyweight, Troy Ounce, Grain, Newton, Pound/Ounce (See technical manual for complete listing)

Operating Modes

Weighing, Parts Counting, Percent Weighing, Checkweighing, Totalization, Display Hold, Only available on STX models: Animal/Dynamic Weighing, Density Determination, Mole Weighing

Power

Multi-range, multi-plug AC power or battery (uses four-AA batteries not included)

Stabilization Time

1 second

Typical Battery Life

SPX422, SPX622, SPX1202, SPX2202, SPX6201: 80 hours
SPX222, SPX421, SPX621, SPX2201, SPX8200: 120 hours

Calibration Weight

SPX222, STX222: 200 g
SPX422, SPX421, STX422, SPT421: 400 g
SPX622, SPX621, STX622, STX621: 600 g
SPX1202 and STX1202: 1,000 g
SPX2202, SPX2201, STX2202, STX2201: 2,000 g
SPX6201: 6,000 g
SPX8200: 8,000 g

Operating Temperature

10° C to 40° C (50° F to 104° F);
10% to 85% at 31° C, decreasing linearly to 50% at 40° C (no condensation)

Est. Weight

2.8 lb (1.24 kg)

Warranty

One-year limited warranty

Return Policy

OHAUS standard policy - restock fee may apply

Model	Capacity	Readability	Repeatability	Linearity	Pan Size	Dimensions	Part #	List Price
LCD Model								
SPX222	220 g	0.01 g	1d	0.01 g	Ø 4.7 in (120 mm)	8 × 8.8 × 2.1 in (202 × 224 × 54 mm)	171986	\$591.00
SPX422	420 g	0.01 g	1d	0.01 g	Ø 4.7 in (120 mm)	8 × 8.8 × 2.1 in (202 × 224 × 54 mm)	171987	\$828.00
SPX622	620 g	0.01 g	1d	0.01 g	Ø 4.7 in (120 mm)	8 × 8.8 × 2.1 in (202 × 224 × 54 mm)	171988	\$971.00
SPX1202	1,200 g	0.01 g	2d	0.01 g	6.7 × 5.5 in (170 × 140 mm)	8 × 8.8 × 2.1 in (202 × 224 × 54 mm)	171989	\$1,108.00
SPX2202	2,200 g	0.01 g	2d	0.01 g	6.7 × 5.5 in (170 × 140 mm)	8 × 8.8 × 2.1 in (202 × 224 × 54 mm)	171990	\$1,245.00
SPX421	420 g	0.1 g	1d	0.1 g	Ø 4.7 in (120 mm)	8 × 8.8 × 2.1 in (202 × 224 × 54 mm)	171991	\$326.00
SPX621	620 g	0.1 g	1d	0.1 g	6.7 × 5.5 in (170 × 140 mm)	8 × 8.8 × 2.1 in (202 × 224 × 54 mm)	171992	\$482.00
SPX2201	2,200 g	0.1 g	1d	0.1 g	6.7 × 5.5 in (170 × 140 mm)	8 × 8.8 × 2.1 in (202 × 224 × 54 mm)	171993	\$617.00
SPX6201	6,200 g	0.1 g	1d	0.2 g	6.7 × 5.5 in (170 × 140 mm)	8 × 8.8 × 2.1 in (202 × 224 × 54 mm)	171994	\$1,008.00
SPX8200	8,200 g	1 g	1d	1 g	6.7 × 5.5 in (170 × 140 mm)	8 × 8.8 × 2.1 in (202 × 224 × 54 mm)	171995	\$504.00



SPX Round Pan

TOPLOADER SCOUT® Series

Model	Capacity	Readability	Repeatability	Linearity	Pan Size	Dimensions	Part #	List Price
Touchscreen Model								
STX222	220 g	0.01 g	1d	0.01 g	Ø 4.7 in (120 mm)	8 × 8.8 × 2.1 in (202 × 224 × 54 mm)	171999	\$680.00
STX422	420 g	0.01 g	1d	0.01 g	Ø 4.7 in (120 mm)	8 × 8.8 × 2.1 in (202 × 224 × 54 mm)	172000	\$950.00
STX622	620 g	0.01 g	1d	0.01 g	Ø 4.7 in (120 mm)	8 × 8.8 × 2.1 in (202 × 224 × 54 mm)	172001	\$1,113.00
STX1202	1,200 g	0.01 g	2d	0.01 g	6.7 × 5.5 in (170 × 140 mm)	8 × 8.8 × 2.1 in (202 × 224 × 54 mm)	172002	\$1,271.00
STX2202	2,200 g	0.01 g	2d	0.01 g	6.7 × 5.5 in (170 × 140mm)	8 × 8.8 × 2.1 in (202 × 224 × 54mm)	172003	\$1,419.00
STX421	420 g	0.01 g	1d	0.01 g	Ø 4.7 in (120mm)	8 × 8.8 × 2.1 in (202 × 224 × 54mm)	172004	\$384.00
STX621	620 g	0.1 g	1d	0.01 g	6.7 × 5.5 in (170 × 140mm)	8 × 8.8 × 2.1 in (202 × 224 × 54mm)	172005	\$575.00
STX2201	2,200 g	0.1 g	1d	0.01 g	6.7 × 5.5 in (170 × 140mm)	8 × 8.8 × 2.1 in (202 × 224 × 54mm)	172006	\$728.00
STX6201	6,200 g	0.1 g	1d	0.02 g	6.7 × 5.5 in (170 × 140mm)	8 × 8.8 × 2.1 in (202 × 224 × 54mm)	172007	\$1,150.00
STX8200	8,200 g	1 g	1d	0.01 g	6.7 × 5.5 in (170 × 140mm)	8 × 8.8 × 2.1 in (202 × 224 × 54mm)	172008	\$596.00

Options/Accessories

Part #	Model #	Description	Price
67413	80850080	WinWedge® TAL Software	\$575.00
181878	30330714	Power supply, US plug, 110/220 VAC	\$31.00



STX Rectangular Pan

TOPLOADER

VALOR® 3000 XTREME Series

Standard Features

- Full 304 stainless steel housing with chemical resistant keypad
- Removable stainless steel weighing pan
- USDA approved
- Supports HACCP
- Resolutions up to 20,000d
- SmarText™ user interface
- Bright backlit LCD display
- Convenient up-front level device
- NSF listed
- NTEP CC 08-008 models available by special order

Specifications

Weighing Units

Gram, Kilogram, Ounce, Pound, Decimal, Pound/Ounce, Fractional Ounces (See technical manual for complete listing)

Operating Modes

Weighing, Percent Weighing, Combined Zero/Tare, Specific Gravity

Power

120 V AC adapter (9 V DC, 0.5 A), four 1.5 Volt C batteries (not included)

Stabilization Time

<3 seconds

Battery life

V31XH202, V31XH402, V31X501: 50 hours with alkaline cells
V31XH2, V31X3, V31XH4, V31X6: 120 hours with alkaline cells

Protection Rating

IP44 (non-washdown)

Calibration

Digital external calibration

Operating Temperature

0° C to 40° C (32° F to 104° F)

Est. Weight

10 lb (4.8 kg)

Warranty

One-year limited warranty

Return Policy

OHAUS Standard Policy - restock fee may apply

Approvals

NSF



Model	Capacity	Readability	Pan Size	Dimensions	Part #	List Price
V31XH202	200 g	0.01 g	4.7 in (120 mm)	8.5 × 7.3 × 3 in (218 × 186 × 72 mm)	100283	\$923.00
V31XH402	400 g	0.01 g	4.7 in (120 mm)	8.5 × 7.3 × 3 in (218 × 186 × 72 mm)	117790	\$1,261.00
V31X501	500 g	0.1 g	4.7 in (120 mm)	8.5 × 7.3 × 3 in (218 × 186 × 72 mm)	117789	\$680.00
V31XH2	2 kg	0.1 g	5.8 × 6.2 in (146 × 158 mm)	8.5 × 7.3 × 3 in (218 × 186 × 72 mm)	100284	\$923.00
V31X3	3 kg	1 g	5.8 × 6.2 in (146 × 158 mm)	8.5 × 7.3 × 3 in (218 × 186 × 72 mm)	100285	\$612.00
V31XH4	4 kg	0.1 g	5.8 × 6.2 in (146 × 158 mm)	8.5 × 7.3 × 3 in (218 × 186 × 72 mm)	117792	\$1,261.00
V31X6	6 kg	1 g	5.8 × 6.2 in (146 × 158 mm)	8.5 × 7.3 × 3 in (218 × 186 × 72 mm)	100286	\$612.00

Options/Accessories

Part #	Model #	Description	Price
103119	80251216	Hardshell carrying case for FD and Valor	\$159.00
102756	80251147	Sandwich pan, 11 in × 5.9 in (280 × 150 mm) for Valor Xtreme	\$104.00
102757	80251148	French fries holder pan for Valor 3000 Xtreme	\$104.00
102758	80251149	Ice cream cone holder for Valor 3000 Xtreme	\$104.00
33451	80850359	Polypropylene Maxi-Scoop™ 10 dia × 2.5 in deep (25.4 dia × 6.4 cm deep) with pouring spout, weight 145 g	\$44.00
100292	80250954	Stainless steel scoop 17.2 × 11 × 3.4 in (44 × 28 × 8.5 cm)	\$105.00
97250	80250400	Stainless steel scoop 11.9 × 7.4 × 1.7 in (30 × 18.7 × 4.3 cm)	\$89.00



Standard Features

- Full 304 stainless steel housing with chemical resistant keypad
- Removable stainless steel weighing pan
- USDA approved
- Supports HACCP
- NTEP CC 08-008 models available

Specifications

Weighing Units

Gram, Kilogram, Decimal Ounce, Fractional Ounces, Pound/Ounces (See technical manual for complete listing)

Operating Modes

Weighing, Percent Weighing, Combined Zero/Tare, Specific Gravity

Power

120 V AC adapter (9 V DC, 0.5 A), four 1.5 Volt C batteries (not included)

Stabilization Time

<3 seconds

Battery Life

V31XW301 and V31XW3: 50 hours with alkaline cells
V31XW6: 120 hours with alkaline cells

Protection Rating

IP65

Calibration

Digital external calibration

Operating Temperature

0° C to 40° C (32° F to 104° F)

Est. Weight

10 lb (4.8 kg)

Warranty

One-year limited warranty

Return Policy

OHAUS Standard Policy - restock fee may apply

Approvals

NTEP: CC 08-008



Model	Capacity	Resolution	Pan Size	Dimensions	Part #	List Price
V31XW301	300 g	0.1 g	5.8 × 6.2 in (146 × 158 mm)	8.5 × 7.3 × 3 in (218 × 186 × 72 mm)	100287	\$717.00
NTEP Certified						
V31XW3	3 kg	1 g	5.8 × 6.2 in (146 × 158 mm)	8.5 × 7.3 × 3 in (218 × 186 × 72 mm)	100288	\$702.00
V31XW6	6 kg	2 g	5.8 × 6.2 in (146 × 158 mm)	8.5 × 7.3 × 3 in (218 × 186 × 72 mm)	100289	\$702.00

Options/Accessories

Part#	Model#	Description	Price
103119	80251216	Hardshell carrying case for FD and Valor	\$159.00
102756	80251147	Sandwich pan, 11 in × 5.9 in (280 × 150 mm) for Valor Xtreme	\$104.00
102757	80251148	French fries holder pan for Valor 3000 Xtreme	\$104.00
102758	80251149	Ice cream cone holder for Valor 3000 Xtreme	\$104.00
33451	80850359	Polypropylene Maxi-Scoop™ 10 dia × 2.5 in deep (25.4 dia × 6.4 cm deep) with pouring spout, weight 145 g	\$44.00
100292	80250954	Stainless steel scoop 17.2 × 11 × 3.4 in (44 × 28 × 8.5 cm)	\$105.00
97250	80250400	Stainless steel scoop 11.9 × 7.4 × 1.7 in (30 × 18.7 × 4.3 cm)	\$89.00



TOPLOADER VALOR[®] 2000 Series Washdown

Standard Features

- Front and rear dual display, 0.8 in (20.5 mm)
- Removable stainless steel platform cover
- Fast 0.5 second stabilization time
- SmarText™ interface
- Knife-proof keypad

Specifications

Weighing Units

Grams, Kilograms, Pounds, Ounces, Pound/Ounce

Operating Modes

Weigh, Checkweigh

Power

Universal AC adapter, 12 VDC 0.7 A internal rechargeable lead acid battery

Stabilization Time

<1 second

Battery Life

50 hours with 1 hour recharge time

Protection Rating

IPX8

Safe Overload

150% of capacity

Calibration

Digital external calibration

Operating Temperature

-10° C to 40° C (14° F to 104° F)

Est. Weight

8.6 lb (3.9 kg)

Warranty

One-year limited warranty

Return Policy

OHAUS Standard Policy - restock fee may apply

Model	Capacity	Readability	Pan Size	Dimensions	Part #	List Price
V22XWE3T	3 kg	0.5 g	7.5x 9.5 in (242 x 190 mm)	10.1 x 11.3 x 4.9 in (256 x 288 x 124 mm)	102771	\$642.00
V22XWE6T	6 kg	1 g	7.5x 9.5 in (242 x 190 mm)	10.1 x 11.3 x 4.9 in (256 x 288 x 124 mm)	102772	\$642.00
V22XWE15T	15 kg	2 g	7.5x 9.5 in (242 x 190 mm)	10.1 x 11.3 x 4.9 in (256 x 288 x 124 mm)	102773	\$642.00

Options/Accessories

Part #	Model #	Description	Price
33451	80850359	Polypropylene Maxi-Scoop™ 10 dia x 2.5 in deep (25.4 dia x 6.4 cm deep) with pouring spout, weight 145 g	\$44.00
97250	80250400	Stainless steel scoop 11.9 x 7.4 x 1.7 in (30 x 18.7 x 4.3 cm)	\$89.00
100292	80250954	Stainless steel scoop 17.2 x 11 x 3.4 in (44 x 28 x 8.5 cm)	\$105.00



TOPLOADER COMPASS CX Series

Standard Features

- Superior RF protection
- Reliable, stable results
- CE listed and FCC Class B Part 15 operation
- Large, removable stainless steel weighing platform
- Low-profile design
- Easy operation
- Low-battery indicator
- Automatic shutoff
- Overload protection
- Push-button calibration

Specifications

Weighing Units

Grams, Pound/Ounce and Newton

Operating Modes

Weighing

Power

3 AA alkaline batteries (included) or AC adapter (not included)

Battery Life

1,000 hours

Stabilization Time

CX221, CX621: 1.5 seconds
 CX1201: 2 seconds
 CX2200, CX5200, CX221P, CX2200P, CX5200P: 1.5 seconds

Operating Temperature

18° C to 25° C (64° F to 77° F)

Calibration Weight

CX221: 200 g
 CX621: 500 g
 CX1201, CX2200: 1 kg
 CX5200: 2 kg

Est. Weight

0.91 lb (0.47 kg)

Warranty

One-year limited warranty

Return Policy

OHAUS Standard Policy - restock fee may apply

Approvals

CE Listed



Model	Capacity	Readability	Repeatability	Linearity	Pan Size	Dimensions	Part #	List Price
CX221	220 g	0.1 g	0.1 g	±0.1 g	5 × 5.6 in (12.7 × 14.2 cm)	5.3 × 7.9 × 1.6 in (13.5 × 20.1 × 4.1 cm)	195245	\$192.00
CX621	620 g	0.1 g	0.1 g	±0.1 g	5 × 5.6 in (12.7 × 14.2 cm)	5.3 × 7.9 × 1.6 in (13.5 × 20.1 × 4.1 cm)	195246	\$198.00
CX1201	1,200 g	0.1 g	0.1 g	±0.1 g	5 × 5.6 in (12.7 × 14.2 cm)	5.3 × 7.9 × 1.6 in (13.5 × 20.1 × 4.1 cm)	195247	\$210.00
CX2200	2,200 g	1 g	1 g	±1 g	5 × 5.6 in (12.7 × 14.2 cm)	5.3 × 7.9 × 1.6 in (13.5 × 20.1 × 4.1 cm)	195248	\$192.00
CX5200	5,200 g	1 g	1 g	±1 g	5 × 5.6 in (12.7 × 14.2 cm)	5.3 × 7.9 × 1.6 in (13.5 × 20.1 × 4.1 cm)	195249	\$226.00
CX221P	220 g	0.1 g	0.1 g	±0.1 g	5 × 5.6 in (12.7 × 14.2 cm)	5.3 × 7.9 × 1.6 in (13.5 × 20.1 × 4.1 cm)	195250	\$206.00
CX2200P	2,200 g	1 g	1 g	±1 g	5 × 5.6 in (12.7 × 14.2 cm)	5.3 × 7.9 × 1.6 in (13.5 × 20.1 × 4.1 cm)	195251	\$207.00
CX5200P	5,200 g	1 g	1 g	±1 g	5 × 5.6 in (12.7 × 14.2 cm)	5.3 × 7.9 × 1.6 in (13.5 × 20.1 × 4.1 cm)	195252	\$226.00

Options/Accessories

Part #	Model #	Description	Price
195254	30467763	Carrying case	\$79.00
181878	30330714	US power adapter	\$31.00
195256	30333865	AU power adapter	\$32.00
195257	30333866	EU power adapter	\$32.00
195258	30333867	UK power adapter	\$32.00
70434	80850075	Bowl, 1,050 mL	\$66.00



TOPLOADER

COMPASS CR Series

Standard Features

- Basic weighing with simple 2-button keypad
- Superior RF protection
- Large weighing platform
- Stackable design with integrated shipping lock
- Low-battery indicator
- Auto shut-off feature
- Mechanical and software overload protection
- External push-button calibration

Specifications

Weighing Units

Grams, Pound/Ounces, Pennyweight, Troy Ounces

Operating Modes

Weighing

Power

3 AA batteries (included) (AC adapter is optional)

Stabilization Time

3 seconds

Battery Life

300 hours

Operating Temperature

18° C to 25° C (65° F to 77° F)

Calibration Weight

CR221: 200 g

CR621: 500 g

CR2200: 1 kg

CR5200: 2 kg

Est. Weight

0.875 lb (0.4 kg)

Warranty

One-year limited warranty

Return Policy

OHAUS Standard Policy - restock fee may apply

Model	Capacity	Readability	Repeatability	Linearity	Pan Size	Dimensions	Part #	List Price
CR221	220 g	0.1 g	0.1 g	± 0.1 g	5 × 5.2 in (12.7 × 13.2 cm)	5.5 × 8.1 × 1.6 in (14 × 20.6 × 4.1 cm)	195265	\$137.00
CR621	620 g	0.1 g	0.1 g	± 0.1 g	5 × 5.2 in (12.7 × 13.2 cm)	5.5 × 8.1 × 1.6 in (14 × 20.6 × 4.1 cm)	195266	\$142.00
CR2200	2,200 g	1 g	1 g	± 1 g	5 × 5.2 in (12.7 × 13.2 cm)	5.5 × 8.1 × 1.6 in (14 × 20.6 × 4.1 cm)	195267	\$137.00
CR5200	5,200 g	1 g	1 g	± 1 g	5 × 5.2 in (12.7 × 13.2 cm)	5.5 × 8.1 × 1.6 in (14 × 20.6 × 4.1 cm)	195268	\$189.00

Options/Accessories

Part #	Model #	Description	Price
194615	30467987	Power adapter	\$47.00
195254	30467763	Carrying case	\$79.00
70434	80850075	Bowl, 1,050 mL	\$66.00



TOPLOADER
HH Series

Standard Features

- Large, 0.4 in (10.16 mm), high-contrast backlit liquid crystal display (LCD)
- Low-battery indicator
- Overload and underload indicators
- Automatic shut-off
- Protective snap-on cover
- Rugged plastic construction

Specifications

Weighing Units

Grams, Ounces, Pennyweight, Troy Ounces

Operating Modes

Weighing

Stabilization Time

3 seconds

Power

Battery operated

Maximum overload

150% of capacity

Calibration

HH1200: Factory set

HH120, HH320: Calibration with keypad

Est. Weight

0.34 lb (0.16 kg)

Warranty

One-year limited warranty

Return Policy

OHAUS Standard Policy - restock fee may apply

Model	Capacity	Readability	Linearity	Pan Size	Dimensions	Part #	List Price
HH120D	60 g/120 g	0.1 g/0.2 g	±0.1 g/±0.2 g	3.25 × 3.2 in (83 × 81 mm)	5.35 × 3.25 × 0.8 in (136 × 83 × 20 mm)	52541	\$223.00
HH120	120 g	0.1 g	±0.1 g	3.25 × 3.2 in (83 × 81 mm)	5.35 × 3.25 × 0.8 in (136 × 83 × 20 mm)	64055	\$266.00
HH320	320 g	0.1 g	±0.2 g	3.25 × 3.2 in (83 × 81 mm)	5.35 × 3.25 × 0.8 in (136 × 83 × 20 mm)	52540	\$330.00



TOPLOADER

YA Series

Standard Features

- Smaller size than most pocket scales allows for a comfortable fit in your pocket
- Clamshell case design protects scale during transport
- Bright blue backlit LCD display
- Automatic shutoff

Specifications**Weighing Units**

Grams, Ounces, Carats, Grains

Operating Modes

Weighing

Power

Two AAA batteries

Est. Weight

0.3 lb

Calibration

External

Warranty

One-year limited warranty

Return Policy

OHAUS Standard Policy - restock fee may apply

Model	Capacity	Readability	Repeatability	Part #	List Price
YA102	100 g	0.01 g	0.01 g	103106	\$133.00
YA302	300 g	0.05 g	0.05 g	103107	\$115.00

Options/Accessories

Part#	Model#	Description	Price
33455	5076-00	Aluminum scoop, 1.5 × 2 in (3.8 × 5.1 cm), weight 4 g	\$44.00
33454	4590-30	Black scoop, aluminum 4 × 3.5 in (10.2 × 8.9 cm), weight 24 g	\$45.00



TOPLOADER VALOR® 1000 Series

Standard Features

- Removable stainless steel platform cover
- Mid-profile ABS plastic housing
- Front-mounted leveling device
- Compact footprint
- Fast response time
- Easy to clean

Specifications

Weighing Units

Gram, Kilogram, Ounce, Pound, Pound/Ounce

Operating Modes

Weigh, Accumulate, Checkweigh

Power

Universal AC adapter included (9 V DC 500 mA)
Four D Cell Alkaline batteries (not included)

Stabilization Time

≤1.5 seconds

Scale Overload

120% of capacity

Decimal Ounce

V12P3: 105 oz × 0.02 oz
V12P6: 210 oz × 0.05 oz
V12P15: 520 oz × 0.1 oz
V12P30: 1058 oz × 0.5 oz

Decimal Pound

V12P3: 6.6 lb × 0.001 lb
V12P6: 13 lb × 0.002 lb
V12P15: 33 lb × 0.01 lb
V12P30: 66 lb × 0.02 lb

Grams

V12P3: 3,000 g × 0.5 g
V12P6: 6,000 g × 1 g
V12P15: 15,000 g × 2 g
V12P30: 30,000 g × 5 g

Operating Temperature

32° F to 104° F (0° C to 40° C) at 10% to 95% relative humidity non-condensing, up to 2.5 miles/4,000 m above sea level

Est. Weight

8.8 lb (4.0 kg)

Battery life

1,500 hours (with/without backlight on)

Warranty

One-year limited warranty

Return Policy

OHAUS Standard Policy - restock fee may apply

Approvals

NSF



Model	Capacity	Readability	Pan Size	Dimensions	Part #	List Price
V12P3	3 kg	0.5 g	7.5 × 9.8 in (190 × 250 mm)	10.1 × 11 × 4.8 in (256 × 280 × 121 mm)	205019	\$245.00
V12P6	6 kg	1 g	7.5 × 9.8 in (190 × 250 mm)	10.1 × 11 × 4.8 in (256 × 280 × 121 mm)	205020	\$245.00
V12P15	15 kg	2 g	7.5 × 9.8 in (190 × 250 mm)	10.1 × 11 × 4.8 in (256 × 280 × 121 mm)	205021	\$245.00
V12P30	30 kg	5 g	7.5 × 9.8 in (190 × 250 mm)	10.1 × 11 × 4.8 in (256 × 280 × 121 mm)	205023	\$245.00

Options/Accessories

Part #	Model #	Description	Price
33451	80850359	Polypropylene Maxi-Scoop™ 10 dia × 2.5 in deep (25.4 dia × 6.4 cm deep) with pouring spout, weight 145 g	\$44.00
97250	80250400	Stainless steel scoop 11.9 × 7.4 × 1.7 in (30 × 18.7 × 4.3 cm)	\$89.00
100292	80250954	Stainless steel scoop 17.2 × 11 × 3.4 in (44 × 28 × 8.5 cm)	\$105.00



HIGH CAPACITY EXPLORER® Series

Standard Features

- AutoCal™ automatic internal calibration for optimized weighing performance
- Touchless IR (infrared) sensors minimize keypad use
- Program IR sensor to control operations including print, tare and other selectable functions
- Color VGA, 5.7-in display with icons for simple menu navigation
- Multiple application modes designed for versatility
- Robust IP 54 die-cast metal bottom housing with stainless steel pan
- Integral weigh below hook
- ENERGY STAR qualified adapter

Specifications

Weighing Units

Gram, Kilogram, Ounce, Pound, Carat, Pennyweight, Grain (See technical manual for complete listing)

Operating Modes

Weighing, Counting, Animal/Dynamic Weighing, Checkweighing, Percent Weighing, Filling, Parts Counting, Totalization, Formulation, Differential Weighing, Density Determination, Peak Hold, Ingredient Costing, SQC

Power

AC adapter input: 100-240 VAC 0.6A 50-60 Hz

Stabilization Time

1 second

Calibration

AutoCal™ on $\Delta 1.5^\circ\text{C}$ temperature change, 11 hours, and external calibration

Operating Temperature

-10°C to 60°C (14°F to 140°F)

Est. Weight

25 lb (12.5 kg)

Warranty

Two-year limited warranty

Return Policy

OHAUS Standard Policy - restock fee may apply

Model	Capacity	Readability	Repeatability	Linearity	Pan Size	Dimensions	Part #	List Price
Ex12001	12,000 g	0.1 g	± 0.1 g	± 0.2 g	14.84 × 12.24 in (377 × 311 mm)	14.84 × 4.72 × 17.44 in (377 × 120 × 443 mm)	157235	\$4,595.00
Ex24001	24,000 g	0.1 g	± 0.1 g	± 0.2 g	14.84 × 12.24 in (377 × 311 mm)	14.84 × 4.72 × 17.44 in (377 × 120 × 443 mm)	157236	\$5,597.00
Ex35001	35,000 g	0.1 g	± 0.1 g	± 0.2 g	14.84 × 12.24 in (377 × 311 mm)	14.84 × 4.72 × 17.44 in (377 × 120 × 443 mm)	157237	\$6,573.00

Options/Accessories

Part#	Model #	Description	Price
157238	30078082	Tower mount display	\$184.00
77712	80500524	RS-232 cable, PC 25-pin to EX	\$232.00
70406	80500525	RS-232 cable, PC 9-pin to EX	\$232.00
156234	46001724	Multi-range AC adapter	\$60.00
156235	46001780	International plug set	\$26.00



MECHANICAL TRIPLE BEAM

Standard Features

- Notched and tiered beams for easy reading
- Positive poise positioning for repeatability
- Magnetically damped
- Zero adjust compensator
- Optional tare beam vernier dial

Specifications

Tare Range

710-T0: 225 g
760-00: 225 g

Pan Design

710-00: Stainless steel pan
710-T0: Stainless steel pan with tare
720-00: Polypropylene scoop
750-S0: Stainless steel plate
760-00: Stainless steel plate with tare
720-S0: Stainless steel scoop

Calibration

Front beam: 10 × 0.1 g
Middle beam: 500 × 100 g
Rear beam: 100 × 10 g

Est. Weight

8 lb

Warranty

Five-year limited warranty

Return Policy

OHAUS Standard Policy - restock fee may apply

Model	Capacity	Readability	Pan Size	Dimensions	Part #	List Price
710-00	610 g	0.1 g	Ø 6 in (152 mm)	18 × 12 × 9 in (457 × 305 × 229 mm)	33350	\$339.00
710-T0	610 g	0.1 g	Ø 6 in (152 mm)	18 × 12 × 9 in (457 × 305 × 229 mm)	33351	\$413.00
720-00	610 g	0.1 g	-	18 × 12 × 9 in (457 × 305 × 229 mm)	33352	\$397.00
750-S0	610 g	0.1 g	Ø 6 in (152 mm)	18 × 12 × 9 in (457 × 305 × 229 mm)	33355	\$187.00
760-00	610 g	0.1 g	Ø 6 in (152 mm)	18 × 12 × 9 in (457 × 305 × 229 mm)	33357	\$349.00
720-S0	610 g	0.1 g	-	18 × 12 × 9 in (457 × 305 × 229 mm)	33353	\$461.00
730-00	610 g	0.1 g	-	18 × 12 × 9 in (457 × 305 × 229 mm)	33354	\$498.00
1650-00*	610 g	0.1 g	6 in (152 mm)	18 × 12 × 9 in (457 × 305 × 229 mm)	33361	\$436.00
1650-W0*	2,610 g	0.1 g	6 in (152 mm)	18 × 12 × 9 in (457 × 305 × 229 mm)	33362	\$503.00
1610-00*	610 g	0.1 g	6 in (152 mm)	18 × 12 × 9 in (457 × 305 × 229 mm)	33360	\$503.00
TP2611	2,610 g	0.1 g	5.8 × 5.8 in (147 × 147 mm)	18 × 12 × 9 in (457 × 305 × 229 mm)	103109	\$268.00

*Dial-O-Gram models

Options/Accessories

Part #	Model #	Description	Price
33417	80780011	Rod and clamp assembly	\$89.00
33446	80780014	Polypropylene scoop, 12 × 6 × 2.75 in (304 × 152 × 70 mm) footed and counterweighted for balance without tare	\$89.00
33447	80780015	Stainless steel scoop, 12 × 6 × 2.75 in (304 × 152 × 70 mm) footed and counterweighted for balance without tare	\$157.00
33448	80780016	Polypropylene Maxi-Scoop®, 10 in (254 mm) dia. × 2.5 in (70 mm) deep with pouring spout and counterweight	\$142.00
33463	80780017	Vinyl dust cover	\$48.00
33414	80780108	Attachment weight set, metric	\$87.00



MECHANICAL

HARVARD TRIP BALANCE

Standard Features

- Highly versatile, rugged, and accurate
- Two-pan design ideal for comparative weighing
- Built-in sliding masses
- Roberval principle
- Magnetic damping
- Comparative weighing

Specifications

Pan Design

Two pan design; stainless steel plate

Calibration

Top beam 10 lb × 0.1 lb; Bottom beam 200 g × 10 g

Warranty

Five-year limited warranty

Return Policy

OHAUS Standard Policy - restock fee may apply

Model	Capacity	Readability	Pan Size	Dimensions	Part #	List Price
1450-SD	2,000 g	0.1 g	6 in (152 mm)	25 × 18 × 22 in (160 × 240 × 140 mm)	33364	\$453.00
1550-SD	2,000 g	0.1 g	6 in (152 mm)	25 × 18 × 22 in (160 × 240 × 140 mm)	33367	\$485.00
1560-SD	2,000 g	0.1 g	6 in (152 mm)	25 × 18 × 22 in (160 × 240 × 140 mm)	33368	\$507.00

Options/Accessories

Part#	Model#	Description	Price
33461	80850262	Vinyl dust cover for Harvard Trip Balances	\$48.00
33417	80780011	Rod and clamp assembly for Triple Beam or Harvard Trip	\$89.00



DIAL-O-GRAM[®] AND CENT-O-GRAM[®]

Standard Features

- 0.01 g or 0.1 g sensitivity
- Equipped for specific gravity weighing
- Four-tiered notched beams
- Easy-to-read vernier dial on model 310
- See-through poise on model 311
- High precision and remarkable value
- Three-point beam eliminates need for level adjustment
- Quick-zeroing with zero adjust knob

Specifications

Operating Mode

310-00: Dial
311-00: Poise

Platform

Stainless steel (removable) 3.5 × 0.5 in (89 × 13 mm)

Est. Weight

5 lb (2.3 kg)

Calibration

Front beam: 225 g tare
Middle beam: 500 g × 100 g
Rear beam: 100 g × 10 g
Dial: 10 g × 0.1 g

Warranty

Five-year limited warranty

Return Policy

OHAUS Standard Policy - restock fee may apply

Model	Capacity	Readability	Pan Size	Part #	List Price
310-00	310 g	0.01 g	6 in (152 mm)	33371	\$491.00
311-00	311 g	0.01 g	6 in (152 mm)	33370	\$406.00

Options/Accessories

Part #	Model #	Description	Price
33420	80780018	Test tube kit	\$48.00
33462	80780005	Vinyl dust cover	\$48.00
Additional OHAUS Mechanical Balance Accessories			
33414	80780108	Metric attachment mass set	\$87.00
33450	80780006	Polypropylene scoop, 12 in × 6 in 2.75 in (304 × 152 × 70 mm) footed, tare 125 g	\$43.00
33451	80850359	Polypropylene Maxi-Scoop [®] , 10 in (254 mm) dia. × 2.5 in (63 mm) D with pouring spout	\$44.00
33454	80250048	Black scoop, aluminum, 4 in × 3.5 in (102 × 89 mm)	\$45.00
33455	80850364	Aluminum scoop, 1.5 in × 2 in (38 × 51 mm)	\$44.00



MECHANICAL FIELD TEST SCALE

Standard Features

- Affordable compact industrial scale
- Large, stabilized pan can hold oversized samples without tipping
- Readings up to 500 g are taken from a single sliding-weight beam, while a set of slotted weights, stored in the base, can extend the capacity up to 36 lb

Specifications

Operating Mode

Poise

Platform

11 in (279 mm)

Calibration

Bottom beam: 500 g × 5 g
Top beam: 1 lb × 0.01 lb

Est. Weight

12 lb (5.4 kg)

Warranty

Five-year limited warranty

Return Policy

OHAUS Standard Policy - restock fee may apply

Model	Capacity	Readability	Pan Size	Part #	List Price
2400-11	16 kg	5 g	11 in (279 mm)	33379	\$1,804.00
2400-12	36 lb	0.01 lb	11 in (279 mm)	33380	\$1,867.00



MECHANICAL HEAVY DUTY SOLUTION

Standard Features

- Sets an industry standard for precision in high-capacity weighing
- Durable enough to resist corrosion
- Sensitive enough to weigh with a feather's touch
- Large stainless steel platform
- Lockable tare for containers up to 2,270 g
- Self-aligning bearings assure a long, maintenance-free life

Specifications

Operating Mode

Poise

Platform

11 in (279 mm)

Calibrations

Front beam: 100 g × 1 g
Rear beam: 1000 g × 100 g

Est. Weight

42 lb

Warranty

Five-year limited warranty

Return Policy

OHAUS Standard Policy - restock fee may apply

Model	Capacity	Readability	Pan Size	Part #	List Price
1119-DO	20 kg	1 g	11 in (279 mm)	33378	\$2,912.00

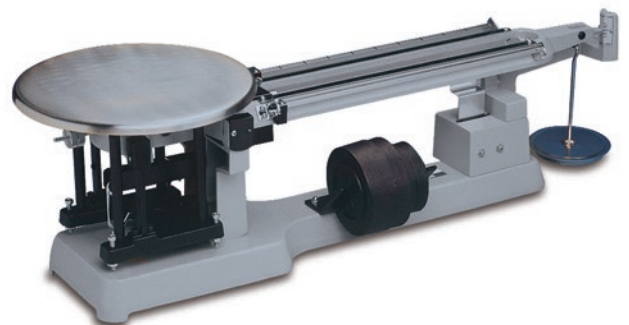

Standard Features

- Fast halogen heating element provides uniform infrared heating and durability for extended use
- Superior weighing performance with readability up to 0.001 g, 0.01% moisture
- Powerful software for simple operation
- Large, backlit liquid crystal display (LCD) for easy viewing (MB23, MB27)
- Bright, easy-to-read touchscreen display (MB90, MB120)
- GLP/GMP compliant format when printed results are required
- RS-232 port for easy communication with printer or PC
- Multi-language display text (English, Spanish, French)

Specifications

Moisture Range

- 110 g: 0.1% to 100%
- 90 g: 0.05% to 100%
- 90 g: 0.01% to 100%
- 120 g: 0.01% to 100% (0.01% to 100% for regain mode)

Power

120 V AC Adapter

Heater Type

- 110 g: Infrared (no glass)
- 90 g - 120 g: Halogen

Timer

- 110 g - 90 g: 1-99 minutes, 30 second increments to 60 minutes
- 90 g: 1-120 minutes in 30 seconds to 60 minute increments, 1 minute increments from 60-120 minutes
- 120 g: 1-120 minutes in 10 second increments

Operating Temperature

- 110 g - 90 g: 5° C to 40° C (41° F to 104° F)
- 90g - 120g: 10° C to 40° C (50° F to 104° F)

Temperature Settings

- 110 g - 90 g: 50° C to 160° C × 5° C (increments)
- 90 g: 40° C to 200° C × 1° C
- 120 g: 40° C to 230° C × 1° C

Est. Weight

14 lb (6.3 kg)

Warranty

Two-year limited warranty

Return Policy

OHAUS Standard Policy - restock fee may apply

Model	Capacity	Readability	Repeatability	Pan Size	Dimensions	Part #	List Price
83999801	110 g	0.01 g	3 g sample-0.3% 10 g sample-0.1%	Ø 9 cm (3.5 in)	7.5 × 6.0 × 14 in (191 × 152 × 356 mm)	109522	\$3,476.00
30251683	90 g	0.001 g	3 g sample-0.2% 10 g sample-0.05%	Ø 9 cm (3.5 in)	6.5 × 5 × 11 in (165 × 127 × 279 mm)	178254	\$3,476.00
30241164	90 g	0.001 g	3 g sample-0.18% 10 g sample-0.02%	Ø 9 cm (3.5 in)	8.3 × 7.7 × 14 in (211 × 196 × 356 mm)	178255	\$4,658.00
30241165	120 g	0.001 g	3 g sample-0.05% 10 g sample-0.015%	Ø 9 cm (3.5 in)	8.3 × 7.7 × 14 in (211 × 196 × 356 mm)	178256	\$5,913.00

Options/Accessories

Part #	Model #	Description	Price
70401	11113857	Temperature calibration kit	\$695.00
70402	80850087	Pads, glass fiber, 200/box	\$124.00
70403	80850086	Sample pans, 80/box, 90 mm diameter	\$79.00
70404	80850088	Reusable sample pans, 3/box	\$243.00
70406	80500525	Cable, 9-pin serial extension	\$232.00
191875	80850043	Security device	\$279.00
67413	80850080	WinWedge® TAL Software	\$575.00



ULTRA-MICRO / MICRO CUBIS® II Series MCA

Standard Features

- Large, high-end, 7in color touchscreen TFT display in 16:9 format
- Modular design
- User configurable and custom designed to meet changing applications
- Meets advanced Pharma compliance including user/password management for security, audit trail function logs and integrated alibi memory
- RS-232 interface for connecting to printer or PC
- M/DH: Automatic glass draft shield
- F: Manual stainless steel draft shield

Specifications

Weighing Units

Milligram, Gram, Kilogram, Ounce, Pound, Carat, Pennyweight, Troy Ounce, Grain, Newton Pound/Ounce, Micrograms (See technical manual for complete listing)

Operating Modes

Mass Unit Conversion, SQ Min Function, ISO-Cal Function, Density Determination (Buoyancy method only with MSE), Calculation, Averaging, Formulation, Percent Weighing, Totalizing, Counting, Customized Identification, Statistics, Time Control Function, Second Tare Memory, Over/Under Checkweighing

Power

120 V AC adapter auto ranging

Stabilization Time

2.7S-2S00-M/F: 7 seconds
6.6S-2S00-M/F, 3.6P-2S00-M: 5 seconds
66S-000-DH, 66P-000-DH, 36S-000-DH, 36P-000-DH: 3.5 seconds

Calibration Weight

2.7S-2S00-M/F: 2 g
6.6S-2S00-M/F: 5 g
3.6P-2S00-M: 3 g
66S-000-DH, 66P-000-DH: 50 g (E2)
36S-000-DH, 36P-000-DH: 20 g (E2)

Weighing Chamber (W × D × H)

8 × 8 × 10.2 in (205 × 205 × 261 mm)

Operating Temperature

5° C to 40° C (41° F to 104° F)

Est. Weight

30 lb

Warranty

Two-year limited warranty

Return Policy

Sartorius Standard Policy - restock fee may apply

Model	Capacity	Readability	Repeatability	Linearity	Pan Size	Dimensions	Part #	List Price
Cubis II								
MCA2.7S- 2S00-M	2.1 g	0.0001 mg	0.25 µg	0.9 µg	Ø 0.8 in (20 mm)	7.55 × 12.72 × 3.46 in 192 mm × 323 mm × 88 mm Chamber Height: 2.75 in (70 mm)	195682	\$39,965.00
MCA2.7S- 2S00-F	2.1 g	0.0001 mg	0.25 µg	0.9 µg	Ø 1.9 in (50 mm)	7.55 × 12.72 × 3.46 in 192 mm × 323 mm × 88 mm Chamber Height: 0.6 in (15 mm) H	195685	\$41,030.00
MCA6.6S- 2S00-M	6.1 g	0.001 mg	0.001 mg	4 µg	Ø 1.2 in (30 mm)	7.55 × 12.72 × 3.46 in 192 mm × 323 mm × 88 mm Chamber Height: 2.75 in (70 mm)	195687	\$31,425.00
MCA6.6S- 2S00-F	6.1 g	0.001 mg	0.001 mg	4 µg	Ø 1.9 in (50 mm)	7.55 × 12.72 × 3.46 in 192 mm × 323 mm × 88 mm Chamber Height: 0.6 in (15 mm)	195690	\$32,495.00
MCA3.6P- 2S00-M	1.1 g / 2.1 g / 3.1 g	0.001 mg / 0.002 mg / 0.005 mg	0.003 /0.004 / 0.005 mg	4 µg	Ø 1.2 in (30 mm)	7.55 × 12.72 × 3.46 in 192 mm × 323 mm × 88 mm Chamber Height: 2.75 in (70 mm)	195692	\$24,235.00
Cubis I								
MSA66S-000-DH	61 g	0.001 mg	0.0015 mg/ 0.004 mg	0.020 mg	1.18 in/1.97 in (30 mm/50 mm)	7.55 × 12.72 × 3.46 in 192 mm × 323 mm × 88 mm Chamber Height: 7.13 in (181 mm)	186390	\$40,165.00
MSA66P-000-DH	12 g/61 g	0.001 mg/ 0.01 mg	0.002 mg/ 0.010 mg	0.020 mg	1.18 in/1.97 in (30 mm/50 mm)	7.55 × 12.72 × 3.46 in 192 mm × 323 mm × 88 mm Chamber Height: 7.13 in (181 mm)	186391	\$36,815.00
MSA36S-000-DH	31 g	0.001 mg	0.0015 mg/ 0.002 mg	0.015 mg	1.18 in (30 mm)	7.55 × 12.72 × 3.46 in 192 mm × 323 mm × 88 mm Chamber Height: 7.13 in (181 mm)	186392	\$34,800.00
MSA36P-000-DH	6 g/31 g	0.001/0.01 mg	0.0015 mg/ 0.008 mg	0.015 mg	1.18 in (30 mm)	7.55 × 12.72 × 3.46 in 192 mm × 323 mm × 88 mm Chamber Height: 7.13 in (181 mm)	186394	\$30,085.00

Options/Accessories

Part #	Model #	Description	Price
Consult	IB	Bluetooth® wireless interface (factory installed)	Consult
Consult	IP	Additional RS-232, 9-Pin connection with PS2 port (factory installed)	Consult
156906	6971987	Power supply, 100-240 V	\$210.00
156908	6900900	Cord, power 220V EU	\$43.00



Standard Features

- State-of-the-art, TFT touchscreen operation
- Fast stabilization time
- Modular design
- User configurable and custom designed to meet changing applications
- Meets advanced Pharma compliance including user/password management for security, audit trail function logs and integrated alibi memory
- RS-232 and USB communication
- Underweigh hook included

OPTIONS

- Bluetooth® wireless technology

Specifications

Weighing Units

Milligram, Gram, Kilogram, Ounce, Pound, Carat, Pennyweight, Troy Ounce, Grain, Newton Pound/Ounce, Micrograms (See technical manual for complete listing)

Operating Modes

Mass Unit Conversion, SQ Min Function, ISO-Cal Function, Density Determination (Buoyancy method only with MSE), Calculation, Averaging, Formulation, Percent Weighing, Totalizing, Counting, Customized Identification, Statistics, Time Control Function, Second Tare Memory, Over/Under Checkweighing

Power

120 V AC adapter auto ranging

Stabilization Time

2.7S-2S00-M/F: 7 seconds
 6.6S-2S00-M/F, 3.6P-2S00-M: 5 seconds

Calibration Weight

2.7S-2S00-M/F: 2 g
 6.6S-2S00-M/F: 5 g
 3.6P-2S00-M: 3 g

Weighing Chamber (W × D × H)

8 × 8 × 10.2 in (205 × 205 × 261 mm)

Operating Temperature

5° C to 40° C (41° F to 104° F)

Est. Weight

30 lb

Warranty

Two-year limited warranty

Return Policy

Sartorius Standard Policy - restock fee may apply

Model	Capacity	Readability	Repeatability	Linearity	Pan Size	Dimensions	Part #	List Price
MCE2.7S- 2S00-M	2.1 g	0.0001 mg	0.25 µg	0.9 µg	Ø 0.8 in (20 mm)	7.55 × 12.72 × 3.46 in 192 mm × 323 mm × 88 mm Chamber Height: 2.75 in (70 mm)	195680	\$39,135.00
MCE2.7S- 2S00-F	2.1 g	0.0001 mg	0.25 µg	0.9 µg	Ø 1.9 in (50 mm)	7.55 × 12.72 × 3.46 in 192 mm × 323 mm × 88 mm Chamber Height: 0.6 in (15 mm) H	195683	\$40,200.00
MCE6.6S- 2S00-M	6.1 g	0.001 mg	0.001 mg	4 µg	Ø 1.2 in (30 mm)	7.55 × 12.72 × 3.46 in 192 mm × 323 mm × 88 mm Chamber Height: 2.75 in (70 mm)	195686	\$30,595.00
MCE6.6S- 2S00-F	6.1 g	0.001 mg	0.001 mg	4 µg	Ø 1.9 in (50 mm)	7.55 × 12.72 × 3.46 in 192 mm × 323 mm × 88 mm Chamber Height: 0.6 in (15 mm)	195689	\$31,660.00
MCE3.6P- 2S00-M	1.1 g / 2.1 g / 3.1 g	0.001 mg / 0.002 mg / 0.005 mg	0.003/0.004/ 0.005 mg	4 µg	Ø 1.2 in (30 mm)	7.55 × 12.72 × 3.46 in 192 mm × 323 mm × 88 mm Chamber Height: 2.75 in (70 mm)	195693	\$23,400.00

Options/Accessories

Part #	Model #	Description	Price
Consult	IB	Bluetooth® wireless interface (factory installed)	Consult
Consult	IP	Additional RS-232, 9-Pin connection with PS2 port (factory installed)	Consult
156906	6971987	Power supply, 100-240V	\$210.00
156908	6900900	Cord, power 220V EU	\$43.00



SEMI-MICRO CUBIS® II MCA Series

Standard Features

- Large, high-end, 7in color touchscreen TFT display in 16:9 format
- Modular design
- User configurable and custom designed to meet changing applications
- Meets advanced Pharma compliance including user/password management for security, audit trail function logs and integrated alibi memory
- RS-232 and USB communication
- Easy cleaning by removing glass doors
- Underweigh hook included
- Manual glass draft shield

Specifications

Weighing Units

Milligram, Gram, Kilogram, Ounce, Pound, Carat, Pennyweight, Troy Ounce, Grain, Newton Pound/Ounce, Micrograms (See technical manual for complete listing)

Operating Modes

Mass Unit Conversion, SQ Min Function, ISO-Cal Function, Density Determination (Buoyancy method only with MSE), Calculation, Averaging, Formulation, Percent Weighing, Totalizing, Counting, Customized Identification, Statistics, Time Control Function, Second Tare Memory, Over/Under Checkweighing

Power

120 V AC adapter auto ranging

Calibration Weight

225S, 225P: 200 g
125P: 100 g

Stabilization Time

225S, 225P, 125P: 2 seconds

Operating Temperature

5° C to 40° C (41° F to 104° F)

Est. Weight

30 lb

Warranty

Two-year limited warranty

Return Policy

Sartorius Standard Policy - restock fee may apply

Model	Capacity	Readability	Repeatability	Linearity	Pan Size	Weighing Chamber	Dimensions	Part #	List Price
MCA225S	220 g	0.01 mg	0.025 mg	0.1 mg	3.3 × 3.3 in (85 × 85 mm)	8 × 8 × 10.2 in (205 × 205 × 261 mm)	16 × 9.8 × 14.6 in (410 × 249 × 370.4 mm)	195698	\$14,790.00
MCA225P	60/120/220 g	0.01/0.02/ 0.05 mg	0.015/0.04 mg	0.15 mg	3.3 × 3.3 in (85 × 85 mm)	8 × 8 × 10.2 in (205 × 205 × 261 mm)	16 × 9.8 × 14.6 in (410 × 249 × 370.4 mm)	195802	\$12,875.00
MCA125P	60/120 g	0.01/0.1 mg	0.015/0.06 mg	0.15 mg	3.3 × 3.3 in (85 × 85 mm)	8 × 8 × 10.2 in (205 × 205 × 261 mm)	16 × 9.8 × 14.6 in (410 × 249 × 370.4 mm)	195803	\$9,595.00

Options/Accessories

Part#	Model #	Description	Price
Consult	DA	Automatic motorized draft shield for analytical balances (factory installed)	Consult
Consult	DI	Automatic motorized draft shield for analytical balances, with integrated ionizer (factory installed)	Consult
Consult	TR	Certificate of compliance and full factory test report (factory installed)	Consult
Consult	IR	Additional RS-232, 25-pin connection (factory installed)	Consult
156906	6971987	Power supply, 100-240 V	\$210.00
156908	6900900	Cord, power 220 V EU	\$43.00
Consult	IB	Bluetooth® wireless interface	Consult
Consult	IP	Additional RS-232, 9-pin connection with PS2 port	Consult



SEMI-MICRO CUBIS® II MCE Series

Standard Features

- State-of-the-art, TFT touchscreen operation
- Modular design
- User configurable and custom designed to meet changing applications
- Meets advanced Pharma compliance including user/password management for security, audit trail function logs and integrated alibi memory
- RS-232 and USB communication
- Easy cleaning by removing glass doors
- Underweigh hook included
- Manual glass draft shield

Specifications

Weighing Units

Milligram, Gram, Kilogram, Ounce, Pound, Carat, Pennyweight, Troy Ounce, Grain, Newton Pound/Ounce, Micrograms (See technical manual for complete listing)

Operating Modes

Mass Unit Conversion, SQ Min Function, ISO-Cal Function, Density Determination (Buoyancy method only with MSE), Calculation, Averaging, Formulation, Percent Weighing, Totalizing, Counting, Customized Identification, Statistics, Time Control Function, Second Tare Memory, Over/Under Checkweighing

Power

120 V AC adapter auto ranging

Calibration Weight

225S, 225P: 200 g
125P: 100 g

Stabilization Time

225S, 225P, 125P: 2 seconds

Operating Temperature

5° C to 40° C (41° F to 104° F)

Est. Weight

30 lb

Warranty

Two-year limited warranty

Return Policy

Sartorius Standard Policy - restock fee may apply

Model	Capacity	Readability	Repeatability	Linearity	Pan Size	Weighing Chamber	Dimensions	Part #	List Price
MCE225S	220 g	0.01 mg	0.025 mg	0.1 mg	3.3 × 3.3 in (85 × 85 mm)	8 × 8 × 10.2 in (205 × 205 × 261 mm)	16 × 9.8 × 14.6 in 410 × 249 × 370.4 mm)	195694	\$13,965.00
MCE225P	60/120/220 g	0.01/0.02/ 0.05 mg	0.015/0.04 mg	0.15 mg	3.3 × 3.3 in (85 × 85 mm)	8 × 8 × 10.2 in (205 × 205 × 261 mm)	16 × 9.8 × 14.6 in 410 × 249 × 370.4 mm)	195797	\$12,045.00
MCE125P	60/120 g	0.01/0.1 mg	0.015/0.06 mg	0.15 mg	3.3 × 3.3 in (85 × 85 mm)	8 × 8 × 10.2 in (205 × 205 × 261 mm)	16 × 9.8 × 14.6 in 410 × 249 × 370.4 mm)	195798	\$8,765.00

Options/Accessories

Part#	Model #	Description	Price
Consult	DA	Automatic motorized draft shield for analytical balances (factory installed)	Consult
Consult	DI	Automatic motorized draft shield for analytical balances, with integrated ionizer (factory installed)	Consult
Consult	TR	Certificate of compliance and full factory test report (factory installed)	Consult
Consult	IR	Additional RS-232, 25-pin connection (factory installed)	Consult
156906	6971987	Power supply, 100-240 V	\$210.00
156908	6900900	Cord, power 220 V EU	\$43.00
Consult	IB	Bluetooth® wireless interface	Consult
Consult	IP	Additional RS-232, 9-pin connection with PS2 port	Consult



SEMI-MICRO

QUINTIX / SECURA Series

Standard Features

- Color capacitive touch with swipe technology
- Simple touch technology
- Monolithic and strain gauge technology
- Aluminum die-cast base, ABS housing
- Integrated level-control
- Mini-USB
- Weigh below hook
- GLP conformance with built-in time and date
- Time and Date

SECURA OPTIONS

- Internal calibration
- Opto-electronic leveling system
- Sqmin safety program
- Analytical draft support ring

Specifications

Operating Modes

Mass Unit Conversion, Counting, Percent Weighing, Averaging

Units of Measure

Gram, Kilogram, Carat, Pound, Ounce, Troy Ounce, Hong Kong Tael, Singapore Tael, Taiwan Tael, Grain, Pennyweights, Milligram, Parts per Pound, China Teal, Mommies, Austrian Carat, Tola, Baht, Mesghal and Newton

Display Type

LCD

Power

12-15 V DC, 4.5 W
AC adapter, 115 V-240 V

Frequency

50-60 Hz

Minimum Weight per USP

Secura 125-1S, Secura 225D-1: 25 mg
Secura 324-1S: 160 mg

External Calibration Weight

Quintix 65-1S: 50 g
Quintix 125D-1S: 100 g
Secura 125-1S: 100 g
Secura 225D-1S: 200 g

Stabilization Time (typical)

Quintix 65-1S: 6 seconds
Quintix 125D-1S: 6/2 seconds
Secura 125-1S: 6 seconds
Secura 225D-1S: 6/2 seconds
Secura 324-1S: 2 seconds

Operating Humidity

Less than 95% RH

Operating Temperature

5° C to 45° C (41° F to 113° F)

Est. Weight

18 lb (7.8 kg)

Warranty

Two-year manufacturer warranty

Return Policy

Sartorius Standard Policy - restock fee may apply

Model	Capacity	Readability	Repeatability	Linearity	Weighing Chamber	Pan Size	Dimensions	Part #	List Price
Quintix									
QUINTIX165-1S	60 g	0.01 mg	0.04 mg	0.1 mg	8.5 in (218 mm)	3.5 in (80 mm)	14.8 × 8.4 × 12.4 in (376 × 214 × 316 mm)	170634	\$6,165.00
QUINTIX125D-1S	60 g/120 g	0.01/0.1 mg	0.04/0.07 mg	0.1/0.2 mg	8.5 in (218 mm)	3.5 in (80 mm)	14.8 × 8.4 × 12.4 in (376 × 214 × 316 mm)	170635	\$6,425.00
Secura									
SECURA125-1S	60 g/120 g	0.01/0.1 mg	0.001 g	0.1 mg	8.5 in (218 mm)	3.15 in (80 mm)	14.8 × 8.4 × 12.4 in (376 × 214 × 316 mm)	170636	\$7,075.00
SECURA225D-1S	120 g/220 g	0.01/0.1 mg	0.001 g	0.1/0.2 mg	8.5 in (218 mm)	3.15 in (80 mm)	14.8 × 8.4 × 12.4 in (376 × 214 × 316 mm)	170380	\$7,430.00

Options/Accessories

Part #	Model #	Description	Price
155847	YCC03-D09	Adapter cable, USB to RS-232	\$64.00



Standard Features

- Simple, color capacitive touch with swipe technology
- Monolithic and strain gauge technology
- Aluminum die-cast base, ABS housing
- Front level bubble
- Mini-USB
- Weigh below hook

QUINTIX AND SECURA OPTIONS

- isoCAL/fully automatic, external calibration
- GLP conformance with built-in time and date

SECURA OPTIONS

- Internal calibration
- Opto-electronic leveling system
- Sqmin safety program
- Analytical draft support ring

Specifications**Operating Modes**

Mass unit conversion, Counting, Percent Weighing, Averaging

Units

Gram, Kilogram, Carat, Pound, Ounce, Troy Ounce, Hong Kong Tael, Singapore Tael, Taiwan Tael, Grain, Pennyweights, Milligram, Parts per Pound, China Teal, Mommies, Austrian Carat, Tola, Baht, Mesghal and Newton

Display Type

LCD

Power Requirements

10-20 V, AC adapter, 115 V-240 V

Frequency

50-60 Hz

Calibration Weight

124-1S: 100 g
224-1S, 213-1S, 313-1S: 200 g
513-1S: 500 g
324-1S: 300 g

Stabilization Time (typical)

3 seconds

Operating Humidity

Less than 95% RH

Operating Temperature

10° C to 30° C (50° F to 86° F)

Est. Weight

11 lb (4.5 kg)

Warranty

Two-year manufacturer warranty

Return Policy

Sartorius Standard Policy - restock fee may apply

Model	Capacity	Readability	Repeatability	Linearity	Weighing Chamber	Pan Size	Dimensions	Part #	List Price
Practum									
PRACTUM124-1S	120 g	0.1 mg	±0.1 mg	±0.3 mg	7.9 in (209 mm)	3.5 in (90 mm)	14.1 × 8.5 × 12.6 in (360 × 216 × 320 mm)	153983	\$2,790.00
PRACTUM224-1S	220 g	0.1 mg	±0.1 mg	±0.3 mg	7.9 in (209 mm)	3.5 in (90 mm)	14.1 × 8.5 × 12.6 in (360 × 216 × 320 mm)	153984	\$3,065.00
Quintix									
QUINTIX124-1S	120 g	0.1 mg	±0.1 mg	0.2 mg	7.9 in (209 mm)	3.5 in (90 mm)	14.1 × 8.5 × 12.6 in (360 × 216 × 320 mm)	153992	\$3,895.00
QUINTIX224-1S	220 g	0.1 mg	±0.1 mg	0.2 mg	7.9 in (209 mm)	3.5 in (90 mm)	14.1 × 8.5 × 12.6 in (360 × 216 × 320 mm)	153993	\$4,410.00
Secura									
SECURA124-1S	120 g	0.1 mg	±0.1 mg	0.2 mg	7.9 in (209 mm)	3.5 in (90 mm)	14.1 × 8.5 × 12.6 in (360 × 216 × 320 mm)	154005	\$4,320.00
SECURA224-1S	220 g	0.1 mg	±0.1 mg	0.2 mg	7.9 in (209 mm)	3.5 in (90 mm)	14.1 × 8.5 × 12.6 in (360 × 216 × 320 mm)	154006	\$4,790.00
SECURA324-1S	320 g	0.1 mg	0.001 g	0.3 mg	8.5 in (218 mm)	3.54 in (90 mm)	14.8 × 8.4 × 12.4 in (376 × 214 × 316 mm)	170637	\$5,640.00

Options/Accessories

Part #	Model #	Description	Price
191429	6971790	AC adapter, 110-240 V, six power plugs	\$61.00
155847	YCC03-D09	Adapter cable, USB to RS-232	\$64.00



ANALYTICAL CUBIS® II MCA Series

Standard Features

- 7 in color touchscreen TFT display in 16:9 format
- Modular design
- User-configurable and custom designed to meet changing applications
- Meets advanced Pharma compliance including user/password management for security, audit trail function logs and integrated alibi memory
- RS-232 and USB communication
- Easy cleaning by removing glass doors
- Underweigh hook included
- Manual glass draft shield

Specifications

Weighing Units

Milligram, Gram, Kilogram, Ounce, Pound, Carat, Pennyweight, Troy Ounce, Grain, Newton Pound/Ounce, Micrograms. (See technical manual for complete listing)

Operating Modes

Mass Unit Conversion, SQ Min Function, ISO-Cal Function, Density Determination (Buoyancy method only with MSE), Calculation, Averaging, Formulation, Percent Weighing, Totalizing, Counting, Customized Identification, Statistics, Time Control Function, Second Tare Memory, Over/Under Checkweighing

Power

120 V AC adapter auto ranging

Stabilization Time

1 second

Calibration Weight

124S: 100 g
224S: 200 g
324S / P: 300 g
524S / P: 500 g

Operating Temperature

5° C to 40° C (41° F to 104° F)

Est. Weight

30 lb

Warranty

Two-year Limited Warranty

Return Policy

Sartorius Standard Policy - restock fee may apply

Model	Capacity	Readability	Repeatability	Linearity	Weighing Chamber	Pan Size	Dimensions	Part #	List Price
MCA with TFT Color Touchscreen									
MCA324P	80/160/320 g	0.1/0.2/0.5 mg	0.1/0.2/0.4 mg	0.5 mg	8 × 8 × 10.2 in (205 × 205 × 261mm)	3.3 × 3.3 in (85 × 85 mm)	16 × 9.8 × 14.6 in (410 × 249 × 370.4 mm)	195805	\$8,745.00
MCA524P	120/240/520 g	0.1/0.2/0.5 mg	0.1/0.2/0.5 mg	0.5 mg	8 × 8 × 10.2 in (205 × 205 × 261mm)	3.3 × 3.3 in (85 × 85 mm)	16 × 9.8 × 14.6 in (410 × 249 × 370.4 mm)	195804	\$9,595.00
MCA124S	120 g	0.1 mg	0.1 mg	0.2 mg	8 × 8 × 10.2 in (205 × 205 × 261mm)	3.3 × 3.3 in (85 × 85 mm)	16 × 9.8 × 14.6 in (410 × 249 × 370.4 mm)	195702	\$7,450.00
MCA224S	220 g	0.1 mg	0.07 mg	0.2 mg	8 × 8 × 10.2 in (205 × 205 × 261mm)	3.3 × 3.3 in (85 × 85 mm)	16 × 9.8 × 14.6 in (410 × 249 × 370.4 mm)	195701	\$8,810.00
MCA324S	320 g	0.1 mg	0.1 mg	0.3 mg	8 × 8 × 10.2 in (205 × 205 × 261mm)	3.3 × 3.3 in (85 × 85 mm)	16 × 9.8 × 14.6 in (410 × 249 × 370.4 mm)	195700	\$9,740.00
MCA524S	520 g	0.1 mg	0.1 mg	0.4 mg	8 × 8 × 10.2 in (205 × 205 × 261mm)	3.3 × 3.3 in (85 × 85 mm)	16 × 9.8 × 14.6 in (410 × 249 × 370.4 mm)	195699	\$11,545.00

Options/Accessories

Part #	Model #	Description	Price
Consult	DA	Automatic motorized draft shield for analytical balances (factory installed)	Consult
Consult	DI	Automatic motorized draft shield for analytical balances, with integrated ionizer (factory installed)	Consult
Consult	TR	Certificate of compliance and full factory test report (factory installed)	Consult
Consult	IR	Additional RS-232, 25-pin connection (factory installed)	Consult
156906	6971987	Power supply, 100-240 V	\$210.00
156908	6900900	Cord, power 220 V EU	\$43.00
Consult	IB	Bluetooth® wireless interface	Consult
Consult	IP	Additional RS-232, 9-pin connection with PS2 port	Consult

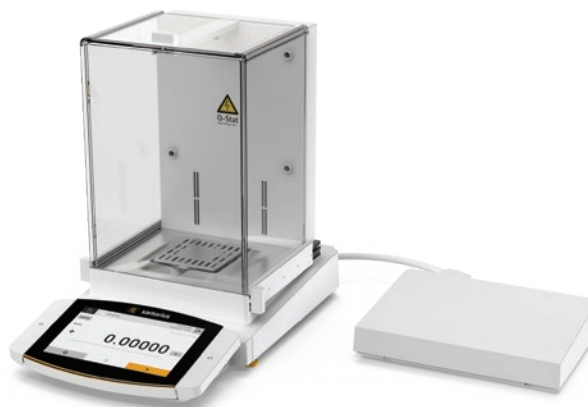

Standard Features

- State-of-the-art TFT touchscreen operation
- Modular design
- User-configurable and custom designed to meet changing applications
- Meets advanced Pharma compliance including user/password management for security, audit trail function logs and integrated alibi memory
- RS-232 and USB communication
- Easy cleaning by removing glass doors
- Underweigh hook included
- Manual glass draft shield

Specifications

Weighing Units

Milligram, Gram, Kilogram, Ounce, Pound, Carat, Pennyweight, Troy Ounce, Grain, Newton Pound/Ounce, Micrograms. (See technical manual for complete listing)

Operating Modes

Mass Unit Conversion, SQ Min Function, ISO-Cal Function, Density Determination (Buoyancy method only with MSE), Calculation, Averaging, Formulation, Percent Weighing, Totalizing, Counting, Customized Identification, Statistics, Time Control Function, Second Tare Memory, Over/Under Checkweighing

Power

120 V AC adapter auto ranging

Stabilization Time

1 second

Calibration Weight

124S: 100 g
224S: 200 g
324S/P: 300 g
524S/P: 500 g

Operating Temperature

5° C to 40° C (41° F to 104° F)

Est. Weight

30 lb

Warranty

Two-year Limited Warranty

Return Policy

Sartorius Standard Policy - restock fee may apply

Model	Capacity	Readability	Repeatability	Linearity	Weighing Chamber	Pan Size	Dimensions	Part #	List Price
MCE with TFT Touchscreen									
MCE324P	80/160/320 g	0.1/0.2/0.5 mg	0.1/0.2/0.4 mg	0.5 mg	8 × 8 × 10.2 in (205 × 205 × 261mm)	3.3 × 3.3 in (85 × 85 mm)	16 × 9.8 × 14.6 in (410 × 249 × 370.4 mm)	195801	\$7,910.00
MCE524P	120/240/520 g	0.1/0.2/0.5 mg	0.1/0.2/0.5 mg	0.5 mg	8 × 8 × 10.2 in (205 × 205 × 261mm)	3.3 × 3.3 in (85 × 85 mm)	16 × 9.8 × 14.6 in (410 × 249 × 370.4 mm)	195800	\$8,765.00
MCE124S	120 g	0.1 mg	0.1 mg	0.2 mg	8 × 8 × 10.2 in (205 × 205 × 261mm)	3.3 × 3.3 in (85 × 85 mm)	16 × 9.8 × 14.6 in (410 × 249 × 370.4 mm)	195697	\$6,620.00
MCE224S	220 g	0.1 mg	0.07 mg	0.2 mg	8 × 8 × 10.2 in (205 × 205 × 261mm)	3.3 × 3.3 in (85 × 85 mm)	16 × 9.8 × 14.6 in (410 × 249 × 370.4 mm)	195696	\$7,975.00
MCE324S	320 g	0.1 mg	0.1 mg	0.3 mg	8 × 8 × 10.2 in (205 × 205 × 261mm)	3.3 × 3.3 in (85 × 85 mm)	16 × 9.8 × 14.6 in (410 × 249 × 370.4 mm)	195695	\$8,905.00
MCE524S	520 g	0.1 mg	0.1 mg	0.4 mg	8 × 8 × 10.2 in (205 × 205 × 261mm)	3.3 × 3.3 in (85 × 85 mm)	16 × 9.8 × 14.6 in (410 × 249 × 370.4 mm)	195799	\$10,720.00

Options/Accessories

Part #	Model #	Description	Price
Consult	DA	Automatic motorized draft shield for analytical balances (factory installed)	Consult
Consult	DI	Automatic motorized draft shield for analytical balances, with integrated ionizer (factory installed)	Consult
Consult	TR	Certificate of compliance and full factory test report (factory installed)	Consult
Consult	IR	Additional RS-232, 25-pin connection (factory installed)	Consult
156906	6971987	Power supply, 100-240 V	\$210.00
156908	6900900	Cord, power 220 V EU	\$43.00
Consult	IB	Bluetooth® wireless interface	Consult
Consult	IP	Additional RS-232, 9-pin connection with PS2 port	Consult



ANALYTICAL ENTRIS II Series Basic Essential

Standard Features

- Backlit LED Touchscreen
- User-friendly operation
- Basic applications
- Monolithic weighing systems
- Aluminum die-cast base, ABS housing
- Front level bubble
- RS-232 standard
- Below balance weighing

Specifications

Weighing Units

Gram, Kilogram, Ounce, Pound, Carat, Pennyweight, Troy Ounce, Grain, Newton (See technical manual for complete listing)

Operating Modes

Weighing, Density, Percentage, Counting, Mass Unit Conversion

Power

AC adapter, 115 V-240 V, US plug

Stabilization Time

2.5 seconds

Operating Humidity

15% to 80% for temperatures up to 31° C

Calibration Weight

BCE64I-1S: 50 g
BCE124I-1S: 100 g
BCE224I-1S: 200 g

Operating Temperature

5° C to 40° C (41° F to 104° F)

Est. Weight

13.7 lb (6.2 kg)

Warranty

Two-year limited warranty

Model	Capacity	Readability	Repeatability	Linearity	Pan Size	Dimensions	Part #	List Price
BCE64I-1S	60 g	0.1 mg	±0.1 mg	±0.2 mg	3.5 in (90 mm)	9.1 × 11.9 × 13 in (230 × 303 × 330 mm)	197392	\$2,465.00
BCE124I-1S	120 g	0.1 mg	±0.1 mg	±0.2 mg	3.5 in (90 mm)	9.1 × 11.9 × 13 in (230 × 303 × 330 mm)	197393	\$2,795.00
BCE224I-1S	220 g	0.1 mg	±0.1 mg	±0.2 mg	3.5 in (90 mm)	9.1 × 11.9 × 13 in (230 × 303 × 330 mm)	197394	\$3,135.00

Options/Accessories

Part#	Model#	Description	Price
112261	YDP20-OCE	Data printer (printer requires power supply part number 191429)	\$1,330.00
31103	6906937	Paper rolls, one roll	\$38.00
31106	6906918	Ink ribbon cassette	\$43.00
201911	YCC-D09MF	Data Cable RS-232, DB-9M to DB-9F (For YDP20 Printer)	\$71.00
204042	YEPS01-PS8	Replacement AC adapter with interchangeable plugs (for use with Entris II)	\$55.00
191429	YEPS01-PS4	AC adapter with interchangeable plugs (for use with YDP20-OCE printer)	\$61.00



ANALYTICAL ENTRIS II Series Basic Advanced

Standard Features

- Graphical Touchscreen
- User-friendly operation
- Basic applications
- Monolithic weighing systems
- Aluminum die-cast base, ABS housing
- Front level bubble
- RS-232 standard
- Below balance weighing

Specifications

Weighing Units

Gram, Kilogram, Carat, Pound, Ounce, Troy Ounce, Hong Kong Tael, Singapore Tael, Taiwan Tael, Grain, Pennyweights, Milligram, Parts per Pound, China Teal, Mommies, Austrian Carat, Tola, Baht, Mesghal, Tons, Pounds, Ounces, Newton

Operating Modes

Weighing, Density, Percentage, Counting, Mass Unit Conversion, Mixing, Statistics, Components, Animal Weighing, Checkweighing, Peak Hold and Pipette Test

Power

AC adapter, 115 V-240 V, US plug

Stabilization Time

BCA64I-1S, BCA124I-1S: 2.5 seconds
BCA224I-1S: 1.3 seconds
BCA324I-1S: 1.0 seconds

Calibration Weight

BCA64I-1S: 50 g
BCA124I-1S: 100 g
BCA224I-1S, BCA324I-1S: 200 g

Operating Temperature

5° C to 40° C (41° F to 104° F)

Operating Humidity

15% to 80% for temperatures up to 31° C

Est. Weight

13.7 lb (6.2 kg)

Warranty

Two-year limited warranty

Model	Capacity	Readability	Repeatability	Linearity	Pan Size	Dimensions	Part #	List Price
BCA64I-1S	60 g	0.1 mg	±0.1 mg	±0.2 mg	3.5 in (90 mm)	20.67 × 19.49 × 15.75 in (52.5 × 49.5 × 40 cm)	202468	\$3,585.00
BCA124I-1S	120 g	0.1 mg	±0.1 mg	±0.2 mg	3.5 in (90 mm)	20.67 × 19.49 × 15.75 in (52.5 × 49.5 × 40 cm)	202469	\$3,915.00
BCA224I-1S	220 g	0.1 mg	±1 mg	±2 mg	4.7 in (120 mm)	20.67 × 19.49 × 15.75 in (52.5 × 49.5 × 40 cm)	202471	\$4,345.00
BCA324I-1S	320 g	0.1 mg	±1 mg	±2 mg	4.7 in (120 mm)	20.67 × 19.49 × 15.75 in (52.5 × 49.5 × 40 cm)	202473	\$4,780.00

Options/Accessories

Part #	Model #	Description	Price
112261	YDP20-OCE	Data printer (printer requires power supply part number 191429)	\$1,330.00
31103	6906937	Paper rolls, one roll	\$38.00
31106	6906918	Ink ribbon cassette	\$43.00
201911	YCC-D09MF	Data Cable RS-232, DB-9M to DB-9F (For YDP20 Printer)	\$71.00
204042	YEPS01-PS8	Replacement AC adapter with interchangeable plugs (for use with Entris II)	\$55.00
191429	YEPS01-PS4	AC adapter with interchangeable plugs (for use with YDP20-OCE printer)	\$61.00



LEGAL FOR TRADE SECURA Series

NEW
NOW NTEP Certified

Standard Features

- Simple, color capacitive touch with swipe technology
- Monolithic and strain gauge technology
- Aluminum die-cast base, ABS housing
- Front level bubble
- Mini-USB
- Weigh below hook

OPTIONS

- isoCAL/fully automatic, external calibration
- Internal calibration
- Opto-electronic leveling system
- GLP conformance with built-in time and date
- Sqmin safety program
- Analytical draft support ring

Specifications

Weighing Units

Mass Unit Conversion, Counting, Percent Weighing, Averaging

Units of Measure

Gram, Kilogram, Carat, Pound, Ounce, Troy Ounce, Hong Kong Tael, Singapore Tael, Taiwan Tael, Grain, Pennyweights, Milligram, Parts per Pound, China Teal, Mommies, Austrian Carat, Tola, Baht, Mesghal and Newton

Display Type

LCD

AC Power Requirements

AC adapter, 115 V-240 V

Frequency

50-60 Hz

Stabilization Time (typical)

3 seconds

Operating Humidity

Less than 95% RH

External Calibration Weight

224-1NUS, 313-1NUS: 200 g
613-1NUS: 500 g
1102-1NUS, 1103-1NUS: 1,000 g
3102-1NUS: 3000g
6101-1NUS, 6102-1NUS: 6000g

Operating Temperature

50° F to 86° F (10° C to 30° C)

Est Weight

9 lb (4.5 kg)

Warranty

Two-year limited warranty

Approvals

NTEP CC: 21-013



Model	Capacity	Readability	Repeatability	Linearity	Pan Size	Dimensions	Part #	List Price
SECURA224-1NUS	220 g	0.1 g	0.5 mg	1 mg	4.73 in (120 mm)	14.1 × 8.5 × 12.6 in (360 × 216 × 320 mm)	207602	\$4,790.00
SECURA313-1NUS	310 g	0.001 g	0.5 mg	2 mg	4.73 in (120 mm)	14.1 × 8.5 × 12.6 in (360 × 216 × 320 mm)	207603	\$2,875.00
SECURA613-1NUS	610 g	0.001 g	0.5 mg	2 mg	4.73 in (120 mm)	14.1 × 8.5 × 12.6 in (360 × 216 × 320 mm)	207604	\$3,835.00
SECURA1102-1NUS	1,100 g	0.01 g	5 mg	0.02 g	7.01 in (180 mm)	14.1 × 8.5 × 12.6 in (360 × 216 × 320 mm)	207605	\$2,515.00
SECURA1103-1NUS	1,100 g	0.001 g	0.5 mg	2 mg	4.73 in (120 mm)	14.1 × 8.5 × 12.6 in (360 × 216 × 320 mm)	207606	\$5,585.00
SECURA3102-1NUS	3,100 g	0.01 g	5 mg	0.02 g	7.01 in (180 mm)	14.1 × 8.5 × 12.6 in (360 × 216 × 320 mm)	207607	\$3,240.00
SECURA6101-1NUS	6,100 g	0.1 g	50 mg	0.1 g	7.01 in (180 mm)	14.1 × 8.5 × 12.6 in (360 × 216 × 320 mm)	207608	\$2,765.00
SECURA6102-1NUS	6,100 g	0.01 g	5 mg	0.02 g	7.01 in (180 mm)	14.1 × 8.5 × 12.6 in (360 × 216 × 320 mm)	207609	\$3,955.00

Options/Accessories

Part #	Model #	Description	Price
191429	6971790	AC adapter, 110-240 V, six power plugs	\$61.00
155847	YCC03-D09	Adapter cable, USB to RS-232	\$64.00





Standard Features

- Backlit LED Touchscreen
- User-friendly operation
- Basic applications
- Monolithic weighing systems
- Aluminum die-cast base, ABS housing
- Front level bubble
- RS-232
- Weigh below hook
- NTEP Certified

Specifications

Weighing Units

Gram, Kilogram, Carat, Pound, Ounce, Troy Ounce, Hong Kong Tael, Singapore Tael, Taiwan Tael, Grain, Pennyweights, Milligram, Parts per Pound, China Teal, Mommies, Austrian Carat, Tola, Baht, Mesghal, Tons, Pounds, Ounces, Newton

Applications

Weighing, Density, Percentage, Counting, Mass Unit Conversion

Display Type

Backlit LCD, 15 mm digits

Operating Humidity

15% to 80% for temperatures up to 31° C

Operating Temperature

41° F to 104° F (5° C to 40° C)

External Calibration Weight

BCE124-1NUS: 100 g
 BCE224-1NUS, BCE324-1NUS: 200 g
 BCE623-1NUS, BCE653-1NUS, BCE622-1NUS, BCE1202-1NUS: 500 g
 BCE3202-1NUS, BCE4202-1NUS, BCE5201-1NUS, BCE6202-1NUS: 5,000 g

Stabilization Time (Typical)

2.5 seconds

Est. Weight

13.7 lb (6.2 kg)

Pan Type

Stainless steel

AC Power Requirements

AC adapter, 115 V-240 V, US plug

Warranty

Two-year limited warranty



Model	Capacity	Readability	NTEP Repeatability	Pan Size	Dimensions	Part #	List Price
BCE124-1NUS	120 g	0.1 mg	1 mg	3.5 in (90 mm)	20.67 × 19.49 × 15.75 in (52.5 × 49.5 × 40 cm)	208212	\$2,465.00
BCE224-1NUS	220 g	0.1 mg	1 mg	3.5 in (90 mm)	20.67 × 19.49 × 15.75 in (52.5 × 49.5 × 40 cm)	208213	\$2,795.00
BCE324-1NUS	320 g	1 mg	10 mg	4.7 in (120 mm)	20.67 × 19.49 × 15.75 in (52.5 × 49.5 × 40 cm)	208214	\$1,450.00
BCE623-1NUS	620 g	1 mg	10 mg	4.7 in (120 mm)	20.67 × 19.49 × 15.75 in (52.5 × 49.5 × 40 cm)	208215	\$2,125.00
BCE653-1NUS	650 g	1 mg	10 mg	4.7 in (120 mm)	20.67 × 19.49 × 15.75 in (52.5 × 49.5 × 40 cm)	208216	\$2,355.00
BCE622-1NUS	620 g	10 mg	0.1 g	4.7 in (120 mm)	20.67 × 19.49 × 15.75 in (52.5 × 49.5 × 40 cm)	208217	\$1,120.00
BCE1202-1NUS	1200 g	10 mg	0.1 g	4.7 in (120 mm)	20.67 × 19.49 × 15.75 in (52.5 × 49.5 × 40 cm)	208218	\$1,345.00
BCE3202-1NUS	3200 g	10 mg	0.1 g	4.7 in (120 mm)	20.67 × 19.49 × 15.75 in (52.5 × 49.5 × 40 cm)	208219	\$1,565.00
BCE4202-1NUS	4200 g	10 mg	0.1 g	4.7 in (120 mm)	20.67 × 19.49 × 15.75 in (52.5 × 49.5 × 40 cm)	208220	\$1,795.00
BCE5201-1NUS	5200 g	0.1 g	0.1 g	4.7 in (120 mm)	20.67 × 19.49 × 15.75 in (52.5 × 49.5 × 40 cm)	208221	\$2,355.00
BCE6202-1NUS	6200 g	10 mg	0.1 g	4.7 in (120 mm)	20.67 × 19.49 × 15.75 in (52.5 × 49.5 × 40 cm)	208222	\$1,345.00

Options/Accessories

Part #	Model #	Description	Price
112261	YDP20-OCE	Data printer (printer requires power supply part number 191429)	\$1,330.00
31103	6906937	Paper rolls, one roll	\$38.00
31106	6906918	Ink ribbon cassette	\$43.00
201911	YCC-D09MF	Data Cable RS-232, DB-9M to DB-9F (For YDP20 Printer)	\$71.00
204042	YEPS01-PS8	Replacement AC adapter with interchangeable plugs (for use with Entris II)	\$55.00
191429	YEPS01-PS4	AC adapter with interchangeable plugs (for use with YDP20-OCE printer)	\$61.00



PRECISION CUBIS® II Series MCA

Standard Features

- Modular design
- User configurable and custom designed to meet changing applications
- Meets advanced Pharma compliance including user/password management for security, audit trail function logs and integrated alibi memory
- RS-232 and USB communication
- Easy cleaning by removing glass doors
- Underweigh hook included
- Manual glass draft shield
- Choice of display
- MCA - Large, high-end, 7 in color touch-screen TFT display in 16:9 format

OPTIONS

- Bluetooth® wireless technology

Specifications

Weighing Units

Milligram, Gram, Kilogram, Ounce, Pound, Carat, Pennyweight, Troy Ounce, Grain, Newton Pound/Ounce, Micrograms (See technical manual for complete listing)

Operating Modes

Mass Unit Conversion, SQ Min Function, ISO-Cal Function, Density Determination (Buoyancy method only with MSE), Calculation, Averaging, Formulation, Percent Weighing, Totalizing, Counting, Customized Identification, Statistics, Time Control Function, Second Tare Memory, Over/Under Checkweighing

Power

120 V AC adapter (auto ranging)

Stabilization Time

3203S, 2203S, 2203P, 1203S, 5203S, 5203P: 1 second
623S, 623P, 323S: 0.8 seconds

Calibration Weight

3203S, 2203S: 2,000 g
2203P, 1203S: 1,000 g
5203S, 5203P: 500 g
623S, 623P: 500 g
323S: 200 g

Operating Temperature

5° C to 40° C (41° F to 104° F)

Est. Weight

17 lb

Warranty

Two-year limited warranty

Return Policy

Sartorius Standard Policy - restock fee may apply

Model	Capacity	Readability	Repeatability	Linearity	Pan Size	Dimensions	Part #	List Price
MCA623P	150/300/620 g	1, 2, 5 mg	1/2/4 mg	5 mg	5.5 × 5.5 in (140 × 140 mm)	16 × 9.8 × 11 in (410 × 249 × 281.4 mm)	195811	\$6,485.00
MCA323S	320 g	1 mg	0.7 mg	2 mg	5.5 × 5.5 in (140 × 140 mm)	16 × 9.8 × 11 in (410 × 249 × 281.4 mm)	195716	\$6,365.00
MCA623S	620 g	1 mg	0.7 mg	2 mg	5.5 × 5.5 in (140 × 140 mm)	16 × 9.8 × 11 in (410 × 249 × 281.4 mm)	195715	\$7,250.00
MCA1203S	1,200 g	1 mg	0.7 mg	2 mg	5.5 × 5.5 in (140 × 140 mm)	16 × 9.8 × 11 in (410 × 249 × 281.4 mm)	195713	\$9,010.00
MCA2203P	1,010/2,200 g	1/10 mg	1/6 mg	5 mg	5.5 × 5.5 in (140 × 140 mm)	16 × 9.8 × 11 in (410 × 249 × 281.4 mm)	195809	\$9,840.00
MCA2203S	2,200 g	1 mg	1 mg	3 mg	5.5 × 5.5 in (140 × 140 mm)	16 × 9.8 × 11 in (410 × 249 × 281.4 mm)	195712	\$10,145.00
MCA3203S	3,200 g	1 mg	1/6 mg	5 mg	5.5 × 5.5 in (140 × 140 mm)	16 × 9.8 × 11 in (410 × 249 × 281.4 mm)	195711	\$9,630.00
MCA5203S	5,200 g	1 mg	1 mg	5 mg	5.5 × 5.5 in (140 × 140 mm)	16 × 9.8 × 11 in (410 × 249 × 281.4 mm)	195714	\$11,925.00
MCA5203P	5,200/2,400/ 1,200 g	5/2/1 mg	1 mg	5 mg	5.5 × 5.5 in (140 × 140 mm)	16 × 9.8 × 11 in (410 × 249 × 281.4 mm)	195810	\$11,410.00

Options/Accessories

Part#	Model#	Description	Price
Consult	TR	Certificate of compliance and full factory test report (factory installed)	Consult
Consult	IR	Additional RS-232, 25-pin connection (factory installed)	Consult
156906	6971987	Power supply, 100-240 V	\$210.00
156908	6900900	Cord, power 220 V EU	\$43.00
Consult	IB	Bluetooth® wireless interface (factory installed)	Consult
Consult	IP	Additional RS-232, 9-pin connection with PS2 port (factory installed)	Consult
Consult	DA, DR, DI or DU	Other draft shields available	Consult



PRECISION
CUBIS® II Series MCE

Standard Features

- Modular design
- User configurable and custom designed to meet changing applications
- Meets advanced Pharma compliance including user/password management for security, audit trail function logs and integrated alibi memory
- RS-232 and USB communication
- Easy cleaning by removing glass doors
- Underweigh hook included
- Manual glass draft shield
- Choice of display
- MCE - State-of-the-art, TFT touchscreen operation

OPTIONS

- Bluetooth® wireless technology

Specifications

Weighing Units

Milligram, Gram, Kilogram, Ounce, Pound, Carat, Pennyweight, Troy Ounce, Grain, Newton Pound/Ounce, Micrograms (See technical manual for complete listing)

Operating Modes

Mass Unit Conversion, SQ Min Function, ISO-Cal Function, Density Determination (Buoyancy method only with MSE), Calculation, Averaging, Formulation, Percent Weighing, Totalizing, Counting, Customized Identification, Statistics, Time Control Function, Second Tare Memory, Over/Under Checkweighing

Power

120 V AC adapter (auto ranging)

Stabilization Time

3203S, 2203S, 2203P, 1203S, 5203S, 5203P: 1 second
 623S, 623P, 323S: 0.8 seconds

Calibration Weight

3203S, 2203S: 2,000 g
 2203P, 1203S: 1,000 g
 5203S, 5203P: 500 g
 623S, 623P: 500 g
 323S: 200 g

Operating Temperature

5° C to 40° C (41° F to 104° F)

Est. Weight

17 lb

Warranty

Two-year limited warranty

Return Policy

Sartorius Standard Policy - restock fee may apply

Model	Capacity	Readability	Repeatability	Linearity	Pan Size	Dimensions	Part #	List Price
MCE323S	320 g	1 mg	0.7 mg	2 mg	5.5 × 5.5 in (140 × 140 mm)	16 × 9.8 × 11 in (410 × 249 × 281.4 mm)	195709	\$5,540.00
MCE623P	150/300/ 620 g	1, 2, 5 mg	1/2/4 mg	5 mg	5.5 × 5.5 in (140 × 140 mm)	16 × 9.8 × 11 in (410 × 249 × 281.4 mm)	195808	\$5,655.00
MCE623S	620 g	1 mg	0.7 mg	2 mg	5.5 × 5.5 in (140 × 140 mm)	16 × 9.8 × 11 in (410 × 249 × 281.4 mm)	195707	\$6,415.00
MCE5203P	5,200/2,400/ 1,200 g	5/2/1 mg	1 mg	5 mg	5.5 × 5.5 in (140 × 140 mm)	16 × 9.8 × 11 in (410 × 249 × 281.4 mm)	195807	\$10,575.00
MCE5203S	5,200 g	1 mg	1 mg	5 mg	5.5 × 5.5 in (140 × 140 mm)	16 × 9.8 × 11 in (410 × 249 × 281.4 mm)	195706	\$11,095.00
MCE1203S	1,200 g	1 mg	0.7 mg	2 mg	5.5 × 5.5 in (140 × 140 mm)	16 × 9.8 × 11 in (410 × 249 × 281.4 mm)	195705	\$8,175.00
MCE2203P	1,010/2,200 g	1/10 mg	1/6 mg	5 mg	5.5 × 5.5 in (140 × 140 mm)	16 × 9.8 × 11 in (410 × 249 × 281.4 mm)	195806	\$9,010.00
MCE2203S	2,200 g	1 mg	1 mg	3 mg	5.5 × 5.5 in (140 × 140 mm)	16 × 9.8 × 11 in (410 × 249 × 281.4 mm)	195704	\$9,315.00
MCE3203S	3,200 g	1 mg	1/6 mg	5 mg	5.5 × 5.5 in (140 × 140 mm)	16 × 9.8 × 11 in (410 × 249 × 281.4 mm)	195703	\$9,630.00

Options/Accessories

Part #	Model #	Description	Price
Consult	TR	Certificate of compliance and full factory test report (factory installed)	Consult
Consult	IR	Additional RS-232, 25-pin connection (factory installed)	Consult
156906	6971987	Power supply, 100-240 V	\$210.00
156908	6900900	Cord, power 220 V EU	\$43.00
Consult	IB	Bluetooth® wireless interface (factory installed)	Consult
Consult	IP	Additional RS-232, 9-pin connection with PS2 port (factory installed)	Consult
Consult	DA, DR, DI or DU	Other draft shields available	Consult

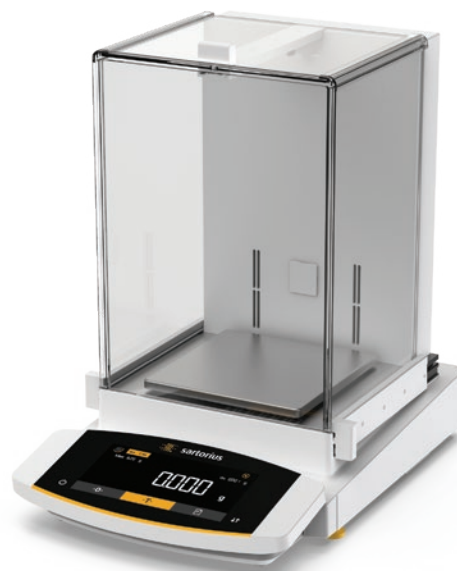

PRECISION

ENTRIS II Series Basic Essential

Standard Features

- Backlit LED Touchscreen
- User-friendly operation
- Basic applications
- Monolithic weighing systems
- Aluminum die-cast base, ABS housing
- Front level bubble
- RS-232
- Weigh below hook

Specifications

Weighing Units

Gram, Kilogram, Ounce, Pound, Carat, Pennyweight, Troy Ounce, Grain, Newton (See technical manual for complete listing)

Operating Modes

Weighing, Density, Percentage, Counting, Mass Unit Conversion

Power

AC adapter, 115 V-240 V, US plug

Stabilization Time

BCE223I-1S: 1.3 seconds
 BCE323I-1S: 1.1 seconds
 BCE423I-1S, BCE623I-1S, BCE622I-1S: 1.0 seconds
 BCE653I-1S: 1.5 seconds

Operating Humidity

15% to 80% for temperatures up to 31° C

Calibration Weight

BCE223I-1S, BCE323I-1S, BCE423I-1S: 200 g
 BCE623I-1S, BCE653I-1S: 500 g

Operating Temperature

5° C to 40° C (41° F to 104° F)

Est. Weight

13.7 lb (6.2 kg)

Warranty

Two-year limited warranty

Model	Capacity	Readability	Repeatability	Linearity	Pan Size	Dimensions	Part #	List Price
BCE223I-1S	220 g	0.001 g	±1mg	±2mg	4.7 in (120mm)	9.1 × 11.9 × 5.4 in (230 × 303 × 136mm)	197395	\$1,565.00
BCE323I-1S	320 g	0.001 g	±1mg	±2mg	4.7 in (120mm)	9.1 × 11.9 × 5.4 in (230 × 303 × 136mm)	197396	\$1,795.00
BCE423I-1S	420 g	0.001 g	±1mg	±2mg	4.7 in (120mm)	9.1 × 11.9 × 5.4 in (230 × 303 × 136mm)	197397	\$2,235.00
BCE623I-1S	620 g	0.001 g	±1mg	±2mg	4.7 in (120mm)	9.1 × 11.9 × 5.4 in (230 × 303 × 136mm)	197398	\$2,465.00
BCE653I-1S	650 g	0.001 g	±1mg	±2mg	4.7 in (120mm)	9.1 × 11.9 × 3.4 in (230 × 303 × 87mm)	197400	\$2,685.00

Options/Accessories

Part #	Model #	Description	Price
112261	YDP20-OCE	Data printer (printer requires power supply part number 191429)	\$1,330.00
31103	6906937	Paper rolls, one roll	\$38.00
31106	6906918	Ink ribbon cassette	\$43.00
201911	YCC-D09MF	Data Cable RS-232, DB-9M to DB-9F (For YDP20 Printer)	\$71.00
204042	YEPS01-PS8	Replacement AC adapter with interchangeable plugs (for use with Entris II)	\$55.00
191429	YEPS01-PS4	AC adapter with interchangeable plugs (for use with YDP20-OCE printer)	\$61.00



PRECISION
ENTRIS II Series Basic Advanced

Standard Features

- User-friendly operation
- Basic applications
- Monolithic weighing systems
- Aluminum die-cast base, ABS housing
- Front level bubble
- RS-232 standard
- Below balance weighing

Specifications

Weighing Units

Gram, Kilogram, Ounce, Pound, Carat, Pennyweight, Troy Ounce, Grain, Newton (See technical manual for complete listing)

Operating Modes

Weighing, Density, Percentage, Counting, Mass Unit Conversion, Mixing, Statistics, Components, Animal Weighing, Checkweighing, Peak Hold and Pipette Test

Power

AC adapter, 115 V-240 V, US plug

Stabilization Time

BCA223I-1S: 2.5 seconds
 BCA323I-1S: 1.1 seconds
 BCA423I-1S, BCA623I-1S: 1.0 seconds
 BCA1203I-1S: 1.5 seconds

Operating Humidity

15% to 80% for temperatures up to 31° C

Calibration Weight

BCA223I-1S, BCA323I-1S: 200 g
 BCA423I-1S, BCA623I-1S, BCA1203I-1S: 500 g

Operating Temperature

5° C to 40° C (41° F to 104° F)

Est. Weight

BCA223I-1S, BCA323I-1S, BCA423I-1S: 13.7 lb (6.2 kg)
 BCA623I-1S: 13.9 lb (6.3 kg)
 BCA1203I-1S: 12 lb (5.4 kg)

Warranty

Two-year limited warranty

Model	Capacity	Readability	Repeatability	Linearity	Pan Size	Dimensions	Part #	List Price
BCA223I-1S	220 g	1 mg	±0.1 mg	±0.2 mg	3.5 in (90 mm)	20.67 × 19.49 × 15.75 in (52.5 × 49.5 × 40 cm)	202470	\$2,285.00
BCA323I-1S	320 g	1 mg	±1 mg	±2 mg	4.7 in (120 mm)	20.67 × 19.49 × 15.75 in (52.5 × 49.5 × 40 cm)	202472	\$2,500.00
BCA423I-1S	420 g	1 mg	±1 mg	±2 mg	4.7 in (120 mm)	20.67 × 19.49 × 15.75 in (52.5 × 49.5 × 40 cm)	202474	\$2,715.00
BCA623I-1S	620 g	1 mg	±1 mg	±2 mg	4.7 in (120 mm)	20.67 × 19.49 × 15.75 in (52.5 × 49.5 × 40 cm)	202475	\$3,260.00
BCA1203I-1S	1,200 g	1 mg	±1 mg	±2 mg	4.7 in (120 mm)	20.67 × 19.49 × 15.75 in (52.5 × 49.5 × 40 cm)	202478	\$4,345.00

Options/Accessories

Part #	Model #	Description	Price
112261	YDP20-OCE	Data printer (printer requires power supply part number 191429)	\$1,330.00
31103	6906937	Paper rolls, one roll	\$38.00
31106	6906918	Ink ribbon cassette	\$43.00
201911	YCC-D09MF	Data Cable RS-232, DB-9M to DB-9F (For YDP20 Printer)	\$71.00
204042	YEPS01-PS8	Replacement AC adapter with interchangeable plugs (for use with Entris II)	\$55.00
191429	YEPS01-PS4	AC adapter with interchangeable plugs (for use with YDP20-OCE printer)	\$61.00



PRECISION

PRACTUM / QUINTIX / SECURA Series

Standard Features

- Simple, color capacitive touch with swipe technology
- Monolithic and strain gauge technology
- Aluminum die-cast base, ABS housing
- Front level bubble
- Mini-USB
- Weigh below hook

QUINTIX AND SECURA OPTIONS

- isoCAL/fully automatic, external calibration
- GLP conformance with built-in time and date

SECURA OPTIONS

- Internal calibration
- Opto-electronic leveling system
- Sqmin safety program
- RS-232 interface cable

Specifications**Operating Modes**

Mass Unit Conversion, Counting,
Percent Weighing, Averaging

Weighing Units

Gram, Kilogram, Carat, Pound, Ounce, Troy Ounce,
Hong Kong Tael, Singapore Tael, Taiwan Tael, Grain,
Pennyweights, Milligram, Parts per Pound, China
Teal, Mommies, Austrian Carat, Tola, Baht, Mesghal
and Newton

Power Requirements

AC adapter, 115-240 VAC

Frequency

50-60 Hz

Display Type

LCD

External Calibration Weight

PRACTUM/ QUINTIX/ SECURA213-1S: 200 g
PRACTUM/ QUINTIX/ SECURA313-1S: 200 g
QUINTIX/ SECURA513-1S: 500 g

Operating Temperature

10° C to 30° C (50° F to 86° F)

Stabilization Time (typical)

3 seconds

Operating Humidity

Less than 95% RH

Est.Weight

4.5 kg (11 lb)

Model	Capacity	Readability	Repeatability	Linearity	Pan Size	Weighing Chamber	Dimensions	Part #	List Price
Practum									
PRACTUM213-1S	210 g	0.001 g	0.001 g	3 mg	120 mm (4.75 in)	209 mm (7.9 in)	360 × 216 × 320 mm (14.1 × 8.5 × 12.6 in)	153985	\$1,590.00
PRACTUM313-1S	310 g	0.001 g	0.001 g	3 mg	120 mm (4.75 in)	209 mm (7.9 in)	360 × 216 × 320 mm (14.1 × 8.5 × 12.6 in)	153986	\$1,710.00
Quintix									
QUINTIX213-1S	210 g	0.001 g	0.001 g	2 mg	120 mm (4.75 in)	209 mm (7.9 in)	360 × 216 × 320 mm (14.1 × 8.5 × 12.6 in)	153994	\$2,305.00
QUINTIX313-1S	310 g	0.001 g	0.001 g	2 mg	120 mm (4.75 in)	209 mm (7.9 in)	360 × 216 × 320 mm (14.1 × 8.5 × 12.6 in)	153995	\$2,465.00
QUINTIX513-1S	510 g	0.001 g	0.001 g	2 mg	120 mm (4.75 in)	209 mm (7.9 in)	360 × 216 × 320 mm (14.1 × 8.5 × 12.6 in)	153996	\$3,335.00
Secura									
SECURA213-1S	210 g	0.001 g	0.001 g	2 mg	120 mm (4.75 in)	209 mm (7.9 in)	360 × 216 × 320 mm (14.1 × 8.5 × 12.6 in)	154007	\$2,645.00
SECURA313-1S	310 g	0.001 g	0.001 g	2 mg	120 mm (4.75 in)	209 mm (7.9 in)	360 × 216 × 320 mm (14.1 × 8.5 × 12.6 in)	154008	\$2,875.00
SECURA513-1S	510 g	0.001 g	0.001 g	2 mg	120 mm (4.75 in)	209 mm (7.9 in)	360 × 216 × 320 mm (14.1 × 8.5 × 12.6 in)	154009	\$3,600.00

Options/Accessories

Part#	Model#	Description	Price
191429	6971790	AC adapter, 110-240 V, six power plugs	\$61.00
155847	YCC03-D09	Adapter cable, USB to RS-232	\$64.00



Standard Features

- Simple, color capacitive touch with swipe technology
- Monolithic and strain gauge technology
- Aluminum die-cast base, ABS housing
- Front level bubble
- Mini-USB
- Weigh below hook

QUINTIX AND SECURA OPTIONS

- isoCAL/fully automatic, external calibration
- GLP conformance with built-in time and date

SECURA OPTIONS

- Internal calibration
- Opto-electronic leveling system
- Sqmin safety program
- Legal for Trade models available

Specifications

Operating Modes

Mass Unit Conversion, Counting, Percent Weighing, Averaging

Weighing Units

Gram, Kilogram, Carat, Pound, Ounce, Troy Ounce, Hong Kong Tael, Singapore Tael, Taiwan Tael, Grain, Pennyweights, Milligram, Parts per Pound, China Teal, Mommies, Austrian Carat, Tola, Baht, Mesghal and Newton

Display Type

LCD

AC Power Requirements

AC adapter, 115 V-240 V

Frequency

50-60 Hz

External Calibration Weight

612-1S: 500 g
1102-1S: 1,000 g
2102-1S: 2,000 g
5101-1S, 5100-1S: 5,000 g

Stabilization Time (typical)

3 seconds

Operating Humidity

Less than 95% RH

Operating Temperature

10° C to 30° C (50° F to 86° F)

Est Weight

9 lb (4.5 kg)

Warranty

Two-year limited warranty

Model	Capacity	Readability	Repeatability	Linearity	Pan Size	Dimensions	Part #	List Price
Practum								
PRACTUM612-1S	610 g	0.01 g	±10 mg	±30 mg	7 in (180 mm)	14.1 × 8.5 × 12.6 in (360 × 216 × 320 mm)	153987	\$1,250.00
PRACTUM1102-1S	1,100 g	0.01 g	±10 mg	±30 mg	7 in (180 mm)	14.1 × 8.5 × 12.6 in (360 × 216 × 320 mm)	153988	\$1,380.00
PRACTUM2102-1S	2,100 g	0.01 g	±10 mg	±30 mg	7 in (180 mm)	14.1 × 8.5 × 12.6 in (360 × 216 × 320 mm)	153989	\$1,440.00
PRACTUM5101-1S	5,100 g	0.1 g	0.1 g	±0.3 g	7 in (180 mm)	14.1 × 8.5 × 12.6 in (360 × 216 × 320 mm)	153991	\$1,470.00
PRACTUM5100-1S	5,100 g	1.0 g	1.0 g	±3.0 g	7 in (180 mm)	14.1 × 8.5 × 12.6 in (360 × 216 × 320 mm)	153990	\$1,135.00
Quintix								
QUINTIX612-1S	610 g	0.01 g	±10 mg	±20 mg	7 in (180 mm)	14.1 × 8.5 × 12.6 in (360 × 216 × 320 mm)	153998	\$1,945.00
QUINTIX1102-1S	1,100 g	0.01 g	±10 mg	±20 mg	7 in (180 mm)	14.1 × 8.5 × 12.6 in (360 × 216 × 320 mm)	153999	\$2,205.00
QUINTIX2102-1S	2,100 g	0.01 g	±10 mg	±20 mg	7 in (180 mm)	14.1 × 8.5 × 12.6 in (360 × 216 × 320 mm)	154000	\$2,465.00
QUINTIX3102-1S	3,100 g	0.01 g	±10 mg	±20 mg	7 in (180 mm)	14.1 × 8.5 × 12.6 in (360 × 216 × 320 mm)	154001	\$2,725.00
QUINTIX5102-1S	5,100 g	0.01 g	±10 mg	±20 mg	7 in (180 mm)	14.1 × 8.5 × 12.6 in (360 × 216 × 320 mm)	154003	\$3,380.00
QUINTIX5101-1S	5,100 g	0.1 g	0.1 g	±0.2 g	7 in (180 mm)	14.1 × 8.5 × 12.6 in (360 × 216 × 320 mm)	154004	\$1,945.00
QUINTIX5100-1S	5,100 g	1.0 g	1.0 g	±0.2 g	7 in (180 mm)	14.1 × 8.5 × 12.6 in (360 × 216 × 320 mm)	154002	\$1,560.00
Secura								
SECURA1102-1S	1,100 g	0.01 g	±10 mg	±20 mg	0 7 in (180 mm)	8.58 × 14.17 × 3.70 in (218 × 360 × 94 mm)	154010	\$2,515.00
SECURA2102-1S	2,100 g	0.01 g	±10 mg	±20 mg	0 7 in (180 mm)	8.58 × 14.17 × 3.70 in (218 × 360 × 94 mm)	154011	\$2,995.00
SECURA3102-1S	3,100 g	0.01 g	±10 mg	±20 mg	0 7 in (180 mm)	8.58 × 14.17 × 3.70 in (218 × 360 × 94 mm)	154012	\$3,240.00
SECURA5102-1S	5,100 g	0.01 g	±10 mg	±20 mg	0 7 in (180 mm)	8.58 × 14.17 × 3.70 in (218 × 360 × 94 mm)	154013	\$3,725.00

Options/Accessories

Part #	Model #	Description	Price
191429	6971790	AC adapter, 110-240 V, six power plugs	\$61.00
155847	YCC03-D09	Adapter cable, USB to RS-232	\$64.00



TOPLOADER CUBIS® II Series MCA

Standard Features

- Fast stabilization time
- Modular design
- User configurable and custom designed to meet changing applications
- Meets advanced Pharma compliance including user/password management for security, audit trail function logs and integrated alibi memory
- RS-232 and USB communication
- Underweigh hook included
- Choice of display
- MCA - Large, high-end, 7in color touch-screen TFT display in 16:9 format

OPTIONS

- Bluetooth® wireless technology

Specifications

Weighing Units

Milligram, Gram, Kilogram, Ounce, Pound, Carat, Pennyweight, Troy Ounce, Grain, Newton Pound/Ounce, Micrograms (See technical manual for complete listing)

Operating Modes

Mass Unit Conversion, SQ Min Function, ISO-Cal Function, Density Determination (Buoyancy method only with MSE), Calculation, Averaging, Formulation, Percent Weighing, Totalizing, Counting, Customized Identification, Statistics, Time Control Function, Second Tare Memory

Power

120 V AC adapter (auto ranging)

Stabilization Time

1202S, 2202S, 4202S, 5201S, 8201S, 12201S: 0.8 seconds
6202P, 6202S, 8202S, 10202S, 5202S, 14202S, 14202P: 1 second

Calibration Weight

1202S: 1 kg
2202S, 4202S: 2 kg
6202S, 8202S, 5201S, 8201S: 5 kg
5202S: 5,000 g
10202S, 12201S, 14202S, 14202P: 10 kg

Operating Temperature

5°C to 40°C (41°F to 104°F)

Est. Weight

21 lb

Warranty

Two-year limited warranty

Return Policy

Sartorius Standard Policy - restock fee may apply

Model	Capacity	Readability	Repeatability	Linearity	Pan Size	Dimensions	Part #	List Price
MCA1202S	1,200 g	10 mg	7 mg	20 mg	8.1 × 8.1 in (206 × 206 mm)	16 × 9.8 × 3.5 in (410 × 249 × 87.7 mm)	195733	\$5,050.00
MCA2202S	2,200 g	10 mg	7 mg	20 mg	8.1 × 8.1 in (206 × 206 mm)	16 × 9.8 × 3.5 in (410 × 249 × 87.7 mm)	195732	\$5,500.00
MCA4202S	4,200 g	10 mg	7 mg	20 mg	8.1 × 8.1 in (206 × 206 mm)	16 × 9.8 × 3.5 in (410 × 249 × 87.7 mm)	195731	\$5,960.00
MCA5201S	5,200 g	100 mg	50 mg	100 mg	8.1 × 8.1 in (206 × 206 mm)	16 × 9.8 × 3.5 in (410 × 249 × 87.7 mm)	195736	\$4,335.00
MCA5202s	5,200 g	0.01 g	0.006 g	0.01 g	8.1 × 8.1 in (206 × 206 mm)	16 × 9.8 × 3.5 in (410 × 249 × 87.7 mm)	195820	\$7,320.00
MCA6202P	1,500 g/3,000 g/ 6,200 g	10 mg/20 mg/ 50 mg	7 mg/20 mg/ 1940 mg	20 mg	8.1 × 8.1 in (206 × 206 mm)	16 × 9.8 × 3.5 in (410 × 249 × 87.7 mm)	195818	\$6,135.00
MCA6202S	6,200 g	10 mg	7 mg	20 mg	8.1 × 8.1 in (206 × 206 mm)	16 × 9.8 × 3.5 in (410 × 249 × 87.7 mm)	195730	\$6,745.00
MCA8201S	8,200 g	100 mg	50 mg	100 mg	8.1 × 8.1 in (206 × 206 mm)	16 × 9.8 × 3.5 in (410 × 249 × 87.7 mm)	195735	\$5,575.00
MCA8202S	8,200 g	10 mg	7 mg	20 mg	8.1 × 8.1 in (206 × 206 mm)	16 × 9.8 × 3.5 in (410 × 249 × 87.7 mm)	195729	\$7,510.00
MCA10202S	10,200 g	10 mg	7 mg	20 mg	8.1 × 8.1 in (206 × 206 mm)	16 × 9.8 × 3.5 in (410 × 249 × 87.7 mm)	195728	\$8,555.00
MCA12201S	12,200 g	100 mg	50 mg	200 mg	8.1 × 8.1 in (206 × 206 mm)	16 × 9.8 × 3.5 in (410 × 249 × 87.7 mm)	195734	\$6,075.00
MCA14202S	14,200 g	0.01 g	0.01 g	0.03 g	8.1 × 8.1 in (206 × 206 mm)	16 × 9.8 × 3.5 in (410 × 249 × 87.7 mm)	195727	\$10,315.00
MCA14202P	3,500 g/7,000 g/ 14,200 g	0.01 g/0.02 g/ 0.05 g	0.05 g	0.05 g	8.1 × 8.1 in (206 × 206 mm)	16 × 9.8 × 3.5 in (410 × 249 × 87.7 mm)	195817	\$9,020.00

Options/Accessories

Part #	Model #	Description	Price
Consult	TR	Certificate of compliance and full factory test report (factory installed)	Consult
Consult	IR	Additional RS-232, 25-pin connection (factory installed)	Consult
156906	6971987	Power supply, 100-240 V	\$210.00
156908	6900900	Cord, power 220V EU	\$43.00
Consult	IB	Bluetooth® wireless interface (factory installed)	Consult
Consult	IP	Additional RS-232, 9-pin connection with PS2 port (factory installed)	Consult



Standard Features

- Fast stabilization time
- Modular design
- User configurable and custom designed to meet changing applications
- Meets advanced Pharma compliance including user/password management for security, audit trail function logs and integrated alibi memory
- RS-232 and USB communication
- Underweigh hook included
- Choice of display
- MCE - State-of-the-art, TFT touchscreen operation

OPTIONS

- Bluetooth® wireless technology

Specifications

Weighing Units

Milligram, Gram, Kilogram, Ounce, Pound, Carat, Pennyweight, Troy Ounce, Grain, Newton Pound/Ounce, Micrograms (See technical manual for complete listing)

Operating Modes

Mass Unit Conversion, SQ Min Function, ISO-Cal Function, Density Determination (Buoyancy method only with MSE), Calculation, Averaging, Formulation, Percent Weighing, Totalizing, Counting, Customized Identification, Statistics, Time Control Function, Second Tare Memory

Power

120 V AC adapter (auto ranging)

Stabilization Time

1202S, 2202S, 4202S, 5201S, 8201S, 12201S: 0.8 seconds
6202P, 6202S, 8202S, 10202S, 5202S, 14202S, 14202P: 1 second

Calibration Weight

1202S: 1 kg
2202S, 4202S: 2 kg
5201S, 6202S, 8201S, 8202S: 5 kg
5202S: 5,000 g
10202S, 12201S, 14202S, 14202P: 10 kg

Operating Temperature

5°C to 40°C (41°F to 104°F)

Est. Weight

21 lb

Warranty

Two-year limited warranty

Return Policy

Sartorius Standard Policy - restock fee may apply

Model	Capacity	Readability	Repeatability	Linearity	Pan Size	Dimensions	Part #	List Price
MCE1202S	1,200 g	10 mg	7 mg	20 mg	8.1 × 8.1 in (206 × 206 mm)	16 × 9.8 × 3.5 in (410 × 249 × 87.7 mm)	195723	\$4,215.00
MCE2202S	2,200 g	10 mg	7 mg	20 mg	8.1 × 8.1 in (206 × 206 mm)	16 × 9.8 × 3.5 in (410 × 249 × 87.7 mm)	195722	\$4,675.00
MCE4202S	4,200 g	10 mg	7 mg	20 mg	8.1 × 8.1 in (206 × 206 mm)	16 × 9.8 × 3.5 in (410 × 249 × 87.7 mm)	195721	\$5,135.00
MCE5201S	5,200 g	100 mg	50 mg	100 mg	8.1 × 8.1 in (206 × 206mm)	16 × 9.8 × 3.5 in (410 × 249 × 87.7mm)	195726	\$3,505.00
MCE5202S	5,200 g	0.01 g	0.006 g	0.01 g	8.1 × 8.1 in (206 × 206mm)	16 × 9.8 × 3.5 in (410 × 249 × 87.7mm)	195816	\$6,490.00
MCE6202P	1,500 g/3,000 g/ 6,200 g	10 mg/20 mg/ 50 mg	7 mg/20 mg/ 1940 mg	20 mg	8.1 × 8.1 in (206 × 206 mm)	16 × 9.8 × 3.5 in (410 × 249 × 87.7 mm)	195815	\$5,305.00
MCE6202S	6,200 g	10 mg	7 mg	20 mg	8.1 × 8.1 in (206 × 206 mm)	16 × 9.8 × 3.5 in (410 × 249 × 87.7 mm)	195720	\$5,915.00
MCE8201S	8,200 g	100 mg	50 mg	100 mg	8.1 × 8.1 in (206 × 206mm)	16 × 9.8 × 3.5 in (410 × 249 × 87.7mm)	195725	\$4,740.00
MCE8202S	8,200 g	10 mg	7 mg	20 mg	8.1 × 8.1 in (206 × 206 mm)	16 × 9.8 × 3.5 in (410 × 249 × 87.7 mm)	195719	\$6,680.00
MCE10202S	10,200 g	10 mg	7 mg	20 mg	8.1 × 8.1 in (206 × 206 mm)	16 × 9.8 × 3.5 in (410 × 249 × 87.7 mm)	195718	\$7,730.00
MCE12201S	12,200 g	100 mg	50 mg	200 mg	8.1 × 8.1 in (206 × 206mm)	16 × 9.8 × 3.5 in (410 × 249 × 87.7mm)	195724	\$5,245.00
MCE14202s	14,200 g	0.01 g	0.01 g	0.03 g	8.1 × 8.1 in (206 × 206mm)	16 × 9.8 × 3.5 in (410 × 249 × 87.7mm)	195717	\$9,485.00
MCE14202P	3,500 g/7,000 g/ 14,200 g	0.01 g / 0.02 g / 0.05 g	0.01 g / 0.02 g / 0.01 g	0.05 g	8.1 × 8.1 in (206 × 206mm)	16 × 9.8 × 3.5 in (410 × 249 × 87.7mm)	195812	\$8,185.00

Options/Accessories

Part#	Model#	Description	Price
Consult	TR	Certificate of compliance and full factory test report (factory installed)	Consult
Consult	IR	Additional RS-232, 25-pin connection (factory installed)	Consult
156906	6971987	Power supply, 100-240 V	\$210.00
156908	6900900	Cord, power 220V EU	\$43.00
Consult	IB	Bluetooth® wireless interface (factory installed)	Consult
Consult	IP	Additional RS-232, 9-pin connection with PS2 port (factory installed)	Consult



TOPLOADER

ENTRIS II Series Basic Essential

Standard Features

- Backlit LED Touchscreen
- User-friendly operation
- Basic applications
- Monolithic weighing systems
- Aluminum die-cast base, ABS housing
- Front level bubble
- RS-232
- Weigh below hook

Specifications

Weighing Units

Gram, Kilogram, Ounce, Pound, Carat, Pennyweight, Troy Ounce, Grain, Newton (See technical manual for complete listing)

Operating Modes

Weighing, Density, Percentage, Counting, Mass Unit Conversion

Power

AC adapter, 115 V-240 V, US plug

Stabilization Time

1.5 seconds

Operating Humidity

15% to 80% for temperatures up to 31° C

Operating Temperature

5° C to 40° C (41° F to 104° F)

Calibration Weight

BCE622I-1S, BCE822II-1S, BCE1202I-1S, BCE2202I-1S: 500 g
BCE2201I-1S: 2,000 g
BCE3202I-1S, BCE4202I-1S, BCE5201I-1S, BCE6202I-1S, BCE6200I-1S, BCE8201I-1S, BCE8200I-1S: 5,000 g

Est Weight

BCE822II-1: 10.6 lb (4.8 kg)
BCE1202I-1S: 12 lb (5.4 kg)
BCE622I-1S, BCE2202I-1S: 13.9 lb (6.3 kg)
BCE2201I-1S, BCE3202I-1S, BCE4202I-1S, BCE5201I-1S, BCE6202I-1S, BCE6200I-1S, BCE8201I-1S, BCE8200I-1S: 12 lb (5.4 kg)

Warranty

Two-year limited warranty

Return Policy

Sartorius Standard Policy - restock fee may apply

Model	Capacity	Readability	Repeatability	Linearity	Pan Size	Dimensions	Part #	List Price
BCE622I-1S	620 g	0.01 g	±1 mg	±2 mg	4.7 in (120 mm)	9.1 × 11.9 × 13 in (230 × 303 × 330 mm)	197399	\$1,450.00
BCE822II-1S	820 g	0.01 g	±1 mg	±2 mg	4.7 in (120 mm)	9.1 × 11.9 × 5.4 in (230 × 303 × 136 mm)	197401	\$1,565.00
BCE1202I-1S	1,200 g	0.01 g	±1 mg	±2 mg	4.7 in (120 mm)	9.1 × 11.9 × 5.4 in (230 × 303 × 136 mm)	197402	\$1,675.00
BCE2202I-1S	2,200 g	0.01 g	±1 mg	±2 mg	4.7 in (120 mm)	9.1 × 11.9 × 5.4 in (230 × 303 × 136 mm)	197403	\$1,795.00
BCE2201I-1S	2,200 g	0.1 g	±0.1 g	±0.3 g	4.7 in (120 mm)	9.1 × 11.9 × 5.4 in (230 × 303 × 136 mm)	197404	\$1,565.00
BCE3202I-1S	3,200 g	0.01 g	±0.1 g	±0.3 g	4.7 in (120 mm)	9.1 × 11.9 × 5.4 in (230 × 303 × 136 mm)	197405	\$1,905.00
BCE4202I-1S	4,200 g	0.01 g	±0.1 g	±0.3 g	7.1 × 7.1 × 3.6 in (180 × 180 × 91 mm)	9.1 × 11.9 × 5.4 in (230 × 303 × 136 mm)	197406	\$2,125.00
BCE5201I-1S	5,200 g	0.1 g	±0.1 g	±0.3 g	7.1 × 7.1 × 3.6 in (180 × 180 × 91 mm)	9.1 × 11.9 × 5.4 in (230 × 303 × 136 mm)	197407	\$1,675.00
BCE6202I-1S	6,200 g	0.01 g	±0.1 g	±0.3 g	7.1 × 7.1 × 3.6 in (180 × 180 × 91 mm)	9.1 × 11.9 × 5.4 in (230 × 303 × 136 mm)	197408	\$2,685.00
BCE6200I-1S	6,200 g	1.0 g	±0.1 g	±0.3 g	7.1 × 7.1 × 3.6 in (180 × 180 × 91 mm)	9.1 × 11.9 × 5.4 in (230 × 303 × 136 mm)	197409	\$1,565.00
BCE8201I-1S	8,200 g	0.1 g	±0.1 g	±0.3 g	7.1 × 7.1 × 3.6 in (180 × 180 × 91 mm)	9.1 × 11.9 × 5.4 in (230 × 303 × 136 mm)	197410	\$1,905.00
BCE8200I-1S	8,200 g	1.0 g	±0.1 g	±0.3 g	7.1 × 7.1 × 3.6 in (180 × 180 × 91 mm)	9.1 × 11.9 × 5.4 in (230 × 303 × 136 mm)	197411	\$1,675.00

Options/Accessories

Part #	Model #	Description	Price
112261	YDP20-OCE	Data printer (printer requires power supply part number 191429)	\$1,330.00
31103	6906937	Paper rolls, one roll	\$38.00
31106	6906918	Ink ribbon cassette	\$43.00
201911	YCC-D09MF	Data Cable RS-232, DB-9M to DB-9F (For YDP20 Printer)	\$71.00
204042	YEPS01-PS8	Replacement AC adapter with interchangeable plugs (for use with Entris II)	\$55.00
191429	YEPS01-PS4	AC adapter with interchangeable plugs (for use with YDP20-OCE printer)	\$61.00



TOPLOADER ENTRIS II Series Basic Advanced

Standard Features

- User-friendly operation
- Basic applications
- Monolithic weighing systems
- Aluminum die-cast base, ABS housing
- Front level bubble
- RS-232 standard
- Below balance weighing

Specifications

Weighing Units

Gram, Kilogram, Ounce, Pound, Carat, Penny-weight, Troy Ounce, Grain, Newton (See technical manual for complete listing)

Operating Modes

Weighing, Density, Percentage, Counting, Mass Unit Conversion, Mixing, Statistics, Components, Animal Weighing, Checkweighing, Peak Hold and Pipette Test

Power

AC adapter, 115 V-240 V, US plug

Stabilization Time (typical)

1.5 seconds

Operating Humidity

15% to 80% for temperatures up to 31° C

Calibration Weight

BCA822I-1S, BCA1202I-1S, BCA2201I-1S: 500 g
BCA2202I-1S: 2,000 g
BCA3202I-1S, BCA4202I-1S, BCA5201I-1S, BCA6202I-1S, BCA8201I-1S, BCA10201I-1S, BCA12201I-1S: 5,000 g

Operating Temperature

5° C to 40° C (41° F to 104° F)

Est. Weight

BCA822I-1S, BCA2201I-1S, BCA2202I-1S, BCA3202I-1S, BCA4202I-1S, BCA5201I-1S, BCA6202I-1S, BCA8201I-1S, BCA10201I-1S, BCA12201I-1S: 13.9 lb (6.3 kg)
BCA1202I-1S: 10.6 lb (4.8 kg)

Warranty

Two-year limited warranty

Return Policy

Sartorius Standard Policy - restock fee may apply

Model	Capacity	Readability	Repeatability	Linearity	Pan Size	Dimensions	Part #	List Price
BCA822I-1S	820 g	10 mg	±1 mg	±2 mg	4.7 in (120 mm)	17.72 × 9.84 × 13.78 in (45 × 25 × 35 cm)	202476	\$2,065.00
BCA1202I-1S	1,200 g	10 mg	±1 mg	±2 mg	4.7 in (120 mm)	17.72 × 9.84 × 13.78 in (45 × 25 × 35 cm)	202477	\$2,285.00
BCA2201I-1S	2,200 g	0.1 g	±1 mg	±2 mg	4.7 in (120 mm)	17.72 × 9.84 × 13.78 in (45 × 25 × 35 cm)	202479	\$1,955.00
BCA2202I-1S	2,200 g	10 mg	±0.1 g	±0.3 g	4.7 in (120 mm)	17.72 × 9.84 × 13.78 in (45 × 25 × 35 cm)	202480	\$2,500.00
BCA3202I-1S	3,200 g	10 mg	±0.1 g	±0.3 g	4.7 in (120 mm)	17.72 × 9.84 × 13.78 in (45 × 25 × 35 cm)	202481	\$2,715.00
BCA4202I-1S	4,200 g	10 mg	±0.1 g	±0.3 g	7.1 × 7.1 × 3.6 in (180 × 180 × 91 mm)	17.72 × 9.84 × 13.78 in (45 × 25 × 35 cm)	202482	\$2,825.00
BCA5201I-1S	5,200 g	0.1 g	±0.1 g	±0.3 g	7.1 × 7.1 × 3.6 in (180 × 180 × 91 mm)	17.72 × 9.84 × 13.78 in (45 × 25 × 35 cm)	202483	\$2,175.00
BCA6202I-1S	6,200 g	10 mg	±0.1 g	±0.3 g	7.1 × 7.1 × 3.6 in (180 × 180 × 91 mm)	17.72 × 9.84 × 13.78 in (45 × 25 × 35 cm)	202484	\$3,915.00
BCA8201I-1S	8,200 g	0.1 g	±0.1 g	±0.3 g	7.1 × 7.1 × 3.6 in (180 × 180 × 91 mm)	17.72 × 9.84 × 13.78 in (45 × 25 × 35 cm)	202485	\$2,605.00
BCA10201I-1S	10,200 g	0.1 g	±0.1 g	±0.3 g	7.1 × 7.1 × 3.6 in (180 × 180 × 91 mm)	17.72 × 9.84 × 13.78 in (45 × 25 × 35 cm)	202486	\$3,915.00
BCA12201I-1S	12,200 g	0.1 g	±0.1 g	±0.3 g	7.1 × 7.1 × 3.6 in (180 × 180 × 91 mm)	17.72 × 9.84 × 13.78 in (45 × 25 × 35 cm)	202487	\$4,130.00

Options/Accessories

Part #	Model #	Description	Price
112261	YDP20-OCE	Data printer (printer requires power supply part number 191429)	\$1,330.00
31103	6906937	Paper rolls, one roll	\$38.00
31106	6906918	Ink ribbon cassette	\$43.00
201911	YCC-D09MF	Data Cable RS-232, DB-9M to DB-9F (For YDP20 Printer)	\$71.00
204042	YEPS01-PS8	Replacement AC adapter with interchangeable plugs (for use with Entris II)	\$55.00
191429	YEPS01-PS4	AC adapter with interchangeable plugs (for use with YDP20-OCE printer)	\$61.00



MOISTURE ANALYZER

MA35, MA37 and MA160 Series

Standard Features

- High-speed measurements
- Effortless cleaning
- User-friendly operation
- Display of process status

Specifications**Heating Element**

MA35, MA37: Infrared metal heating element
 MA160: Infrared radiation by an AURI heater, 600 W

Heating Mode

MA35, MA37: Standard drying
 MA160: Standard drying, gentle drying

Power

120/230 VAC multi-range adapter

Display Modes for Results

Moisture content in % M and g; dry matter in % S
 and g; ATRO in % M/S

Data Interface

MA35: RS-232
 MA37: Mini USB
 MA160: M-Mini USB

Calibration Weight

MA35: 30 g
 MA37: 50 g
 MA160: 200 g

Operating Temperature

10° C to 30° C (50° F to 86° F)

Temperature Range and Settings

40° C to 160° C (104° F to 320° F)

Est. Weight

MA35: 12.8 lb (5.8 kg)
 MA37, MA160: 13.7 lb (6.2 kg)

Warranty

Two-year limited warranty

Return Policy

Sartorius Standard Policy - restock fee may apply

Model	Capacity	Readability	Repeatability	Pan Size	Dimensions	Part #	List Price
MA35	35 g	0.001 g	For initial sample weight approx $>1 \pm 0.2\%$; for initial sample weight $>5 \pm 0.05\%$	90 mm	8.8 × 14.4 × 7.5in (224 × 366 × 191 mm)	191983	\$2,780.00
MA37	70 g	0.001 g	For initial sample weight approx $>1 \pm 0.2\%$; for initial sample weight $>5 \pm 0.05\%$	90 mm	8.5 × 15.7 × 8.3in (215 × 400 × 210 mm)	165963	\$3,900.00
MA160	200 g	0.01 g	For initial sample weight approx $>1 \pm 0.2\%$; for initial sample weight $>5 \pm 0.05\%$	90 mm	8.5 × 15.7 × 8.3in (215 × 400 × 210 mm)	165964	\$4,920.00



Standard Features

- Converts serial data such as bar code reader or scale into keyboard input to software program
- Works with PC and MAC® computers
- Requires no driver installation (identifies itself as additional HID keyboard)
- Cable draws power from USB port (no external power supply needed)
- Test cable to be connected with adaptor scale cable or connector
- Bluetooth® version allows Bluetooth® connection to devices like iPad®, Playbook, Android® tablets and smart phones

Specifications

Baud Rate
9600

Color
Black

Cable Length
74 in (1880 mm)

Bluetooth Cable Length
16 in (406 mm)

Power
USB power, no external power supply

Host
PC and MAC® compliant

Connection
DB9 male connector, Pin 2 RX, Pin 3 TX and Pin 5 Ground
USB A connector

Part Number/Price

Part #	Description	Weight	Price
119919	RS-232/USB serial cable	1lb	\$190.00
132452	RS-232/USB serial cable plus Bluetooth®	1lb	\$275.00

Options/Accessories

Part #	Description	Price
119064	Slimline null modem, gender changer DB9 female to female	\$11.00
22436	Blunt-end to DB9 female, straight cable	\$67.00
50749	DB9 female to DB9 female	\$60.00
130789	Null model DB9 adapter female to male	\$13.00



DATA CAPTURE AND STORAGE GO-BETWEEN™

Standard Features

- LED onboard for testing data transmission
- Captures data and stores it on a USB flash drive (up to 8 GB not included)
- Transfer data to your PC using the USB flash drive
- Text file examples (actual text will be dependent on transmitted file)

02:50PM
11/13/2012
GROSS 58 lb
02:50PM
11/13/2012
GROSS 68 lb

Specifications

Baud Rate

9600

Data Bits

8

Parity

None

Power

Requires 5 VDC

Customer Supplied

Power and USB flash drive

Industrial Enclosure Option

7.5 × 7.5 × 4.5 in (19 × 19 × 12 cm)

Latch for lock

Warranty

One-year limited warranty

Part Number/Price

Part #	Description	Price
153265	go-between board, requires 5 Volts	\$435.00
153266	go-between industrial enclosure, requires 5 Volts	\$630.00
153267	go-between desk enclosure, power supply included	\$525.00

Options/Accessories

Part #	Description	Price
154797	Adapter, power 5 VDC 2A 90-264 VAC, U.S. plug, UL/CUL	\$37.00
195607	USB flash drive, 8 GB	\$7.00
130789	Null model DB9 adapter female to male	\$13.00
119064	Null modem adapter, DB9 F/F	\$11.00
50764	Straight cable, DB9 F/F	\$69.00
66535	Null modem DB9 F/F	\$46.00
22436	DB9 cable to blunt end	\$67.00
15493	Cable four-conductor	\$1.55/ft



KASOTA STONE BALANCE SLAB

Standard Features

- Balance slabs
- Balance tables
- Anti-vibration



Reduces vibration and shock, ideal where tables will not fit.

Part Number/Price

Part #	Description	Price
Standard Balance Slab, Kasota Stone		
83779	15 in × 20 in × 3 in, 100 lb	\$475.00

KASOTA STONE BALANCE TABLE

Standard Features

- Balance slabs
- Balance tables
- Anti-vibration



Provides the most stable surface possible for precision instruments. Legs are reinforced with support pipe.

Part Number/Price

Part #	Description	Price
Standard Balance Table, Kasota Stone		
83778	24 in × 35 in × 32 in, 700 lb	\$1,260.00

GRANITE CLEAN ROOM TABLE

Standard Features

- Balance slabs
- Balance tables
- Anti-vibration



Mass, density and vibration damping properties for most applications (four damping pads included).

Part Number/Price

Part #	Description	Price
Clean Room Table, Granite		
83780	24 in × 35 in × 32 in, 600 lb	\$2,850.00

ANTI-VIBRATION PAD

Standard Features

- Balance slabs
- Balance tables
- Anti-vibration

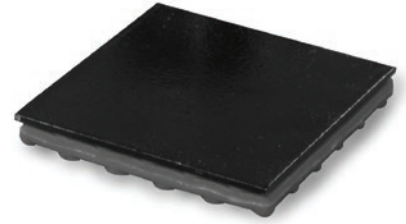

Part Number/Price

Part #	Description	Price
Anti-Vibration Pad		
75263	Anti-vibration pad 4 × 4 1/2 in-thick	\$15.75

SCOOPS

Standard Features

- Aluminum
- Polypropylene
- Stainless steel



PN 33447

Part Number/Price

Part #	Description	Price
33455	Aluminum, 1.5 × 2.0 in (3.8 × 5.1 cm)	\$44.00
33446	Polypropylene, 12 × 6 × 2.75 in (304 × 152 × 70 mm)	\$89.00
33447	Stainless steel, 12 × 6 × 2.75 in (304 × 152 × 70 mm)	\$157.00
33448	Polypropylene Maxi-scoop, 10 in (254 mm) diameter × 2.5 in (70 mm) deep with pouring spout	\$142.00
33454	Black, aluminum 4.0 × 3.5 in (10.2 × 8.9 cm)	\$45.00
33451	Polypropylene Maxi-scoop	\$44.00
97250	Stainless steel scoop 11.9 × 7.4 × 1.7 in	\$89.00
100292	Stainless steel scoop 17.2 × 11 × 3.4 in	\$105.00



PN 33455



PN 33451



PN 33454

STATIC CONTROL

NRD is the industry leader for providing advanced ionization products to eliminate electrostatic discharge and static attraction. The success of NRD devices is based on unique and extremely effective ionization sources that use alpha-energy to neutralize static electricity. Unlike electrical ionization systems, NRD ion sources don't just control static, they eliminate it by providing a constant balance of \pm zero volts.

The ion sources are entirely self-powered and never require any calibration or adjustment; therefore, there are no operating costs associated with them throughout their lifetime. Because NRD ion sources do not require electricity and are completely safe, they are ideal for use in any application, including highly-volatile environments.

Static charge buildup is the cause of many production problems including downtime, reduced product quality, and ultimately increased costs and reduced profits. Although the static charges cannot be seen, they are quite noticeable.

Thousands of volts of electricity can easily accumulate on the surfaces of in-process materials. This buildup can ignite combustibles, shock personnel, destroy sensitive electronic components and cause many types of production problems. In addition, static attraction of dirt, dust, and other foreign matter contaminates products and process equipment, which intensifies processing problems.

NRD alpha-energy devices rapidly neutralize charged materials. This is accomplished by emitting a flood of both

positively and negatively charged ions in the vicinity of the affected material. The charged material then attracts a sufficient quantity of oppositely charged ions to completely eliminate its static charge.

NRD alpha-energy ion sources totally eliminate static buildup, not just reduce it, as with other methods of static control. As with all types of ion sources, ionized air has absolutely no adverse effects on personnel.



1in Static Brush

3in Static Brush

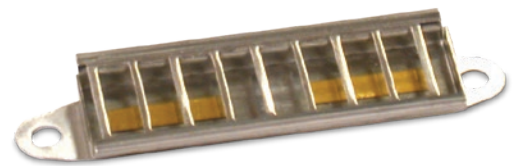

1in x 3in Ionizing Strip



1in x 1in Ionizing Strip



Stand Ionizer

STATIC BRUSHES, IONIZING STRIPS AND ACCESSORIES

STATIC CONTROL

Ionizers

Part #	Staticmaster Part #	Description	Price
164648	4068	Mini-fan ionizer	\$140.00
164649	6105	I-beam stand ionizer	\$1,070.00

Static Brushes - 1 inch

Part #	Staticmaster Part #	Description	Price
76669	1C200	Static brush, 1 in	\$140.00
76670	1C200R	Replacement cartridge	\$90.00

Static Brushes - 3 inch

Part #	Staticmaster Part #	Description	Price
76671	3C500	Static brush, 3 in	\$210.00
76672	3C500R	Replacement cartridge	\$145.00

Ionizing Strips - 1 inch

Part #	Staticmaster Part #	Description	Price
76677	1U400	Ionizing unit 1 in	\$145.00
76678	1U200	Ionizing unit 1 in	\$90.00

Ionizing Strips - 3 inch

Part #	Staticmaster Part #	Description	Price
76676	2U500	Ionizing unit 1 in × 3 in	\$134.00

Ionizing Strip Accessories

Part #	Staticmaster Part #	Description	Price
76679	BF1	Ionizer positioner	\$73.00
76680	BF2	Ionizer positioner only - C bracket	\$105.00
163601	BF3	EZ-Mount, 2U500 BF3 option mounts 2U500 to balance chamber	\$15.75
163602	5060	Grounding kit, 2U500 5060 enhances static eliminating power Staticmaster 2U500	\$31.50



Mini-fan Ionizer





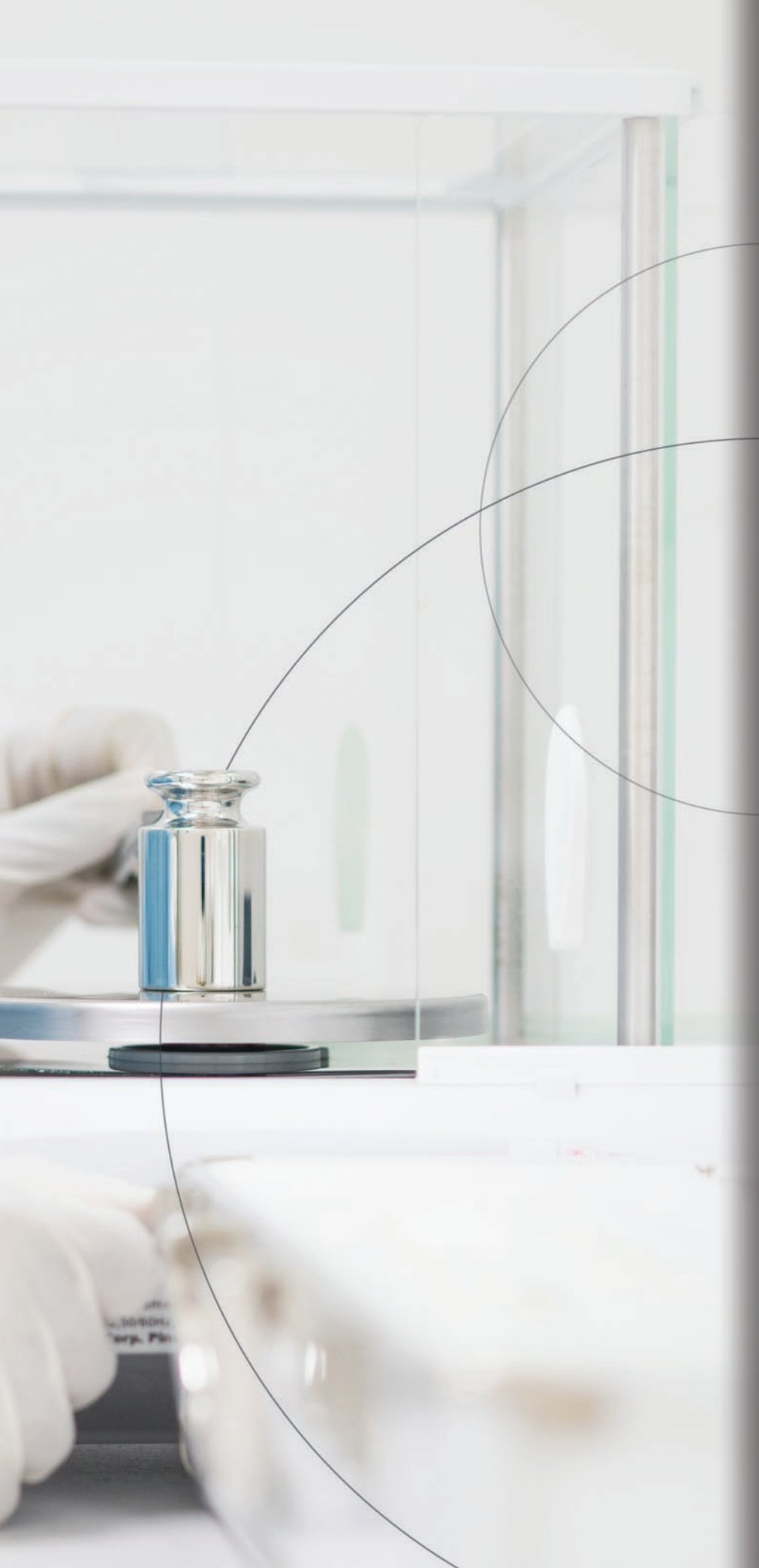

TABLE OF CONTENTS

- 234** Precision Mass Reference Standards and Calibration Weights
- 236** Weight Classification, International Laboratory Weights and Precision Mass Standards
- 238** Weight Classification, U.S. Laboratory Weights and Precision Mass Standards
- 240** Metric Weight Tolerances
- 241** Weight Classification, U.S. Field Standard
- 242** Weight Tolerance, Metric
- 243** Weight Tolerance, Avoirdupois
- 244** Weight Tolerance, Avoirdupois Ounces
- 245** Weight Tolerance, Troy Ounces
- 246** Weight Tolerance, Pennyweight and Grain
- 247** Weight Tolerance, Carats, Apothecary Scruples
- 248** Weight Tolerances for Historical NIST Handbook 105-1 (1990)
- 249** Conversion Factors for Units of Measure
- 250** Weight Cleaning Procedures
- 252** Environmental Impacts on Precise Measurements
- 254** Weights, Balances and Uncertainty
- 258** Properties of Magnetism in Mass Standards
- 261** Balance Verification Using Calibrated Weights
- 264** Glossary of Terms
- 266** A New Era of Measurement with the Redefined Kilogram
- 267** Historical Class F Calibration Weights
- 268** Trademarks
- 269** Terms and Conditions
- 271** Warranty and Limitation of Liability
- 275** Ingress Protection (IP) Ratings
- 275** Conversions
- 276** Shipping Information

Precision Mass Reference Standards and Calibration Weights

The following pages of this catalog contain all the information you'll need to place your mass standard or calibration weight order. If you're new to the specialized field of metrological weights, the selection process can be broken into five simple steps:

1. Determine the regulatory standard that applies to your application. The international standard (OIML) is summarized on page 240; the U.S. standard (ASTM E 617) is summarized on page 242; the U.S. commercial standard for Legal for Trade applications (NIST Handbook 105-1) is summarized on page 245.
2. Determine the accuracy class appropriate for your application by reviewing the accuracy and tolerance information below and starting on page 244, as well as your internal ISO documentation and any applicable manufacturer's instructions.
3. Determine the type of laboratory documentation you require using the information.
4. Using the information from steps 1–3, select the weight or weight set and appropriate laboratory documentation for your application.
5. If your weights will require Legal for Trade certification prior to placing them in service, decide if you would like the certification to be handled by Rice Lake Weighing Systems' metrology labs - Wisconsin or California - accredited by the National Voluntary Laboratory Accreditation Program (NVLAP), or sent to your state lab. For more information on the certification process of NVLAP-accredited labs see page 2

Accuracy Classes

Current Standard and Test Weight Accuracy Classes			Historical Classes	
Typical Use	OIML ¹	ASTM E617 ²	NIST 105-1 ³	NBS CIR. 547 ³

Certificate of Weight Calibration (Accredited) Is Recommended for...

Primary Laboratory Reference Standard High precision standards for calibration of weights and special precision analytical balances accuracy Classes I and II (class number depending on precision).	E1	00		
	E2			
		0 and 1		M and S

Certificate of Weight Calibration (Non-accredited) Is Recommended for...

High Accuracy Balances Working standard for precision analytical work, built-in weights and external weights used to calibrate moderate precision balances.	F1	2		
		3		S1
	F2			

Statement of Accuracy Is Acceptable for...

Industrial Scales and Balances Accuracy Class III industrial scales, dial scales, trip balances, platform scales. Also used for accuracy Class III L and III L, and weights used to calibrate scales in Legal for Trade applications.		4		P
	M1	5		Q
	M2	6	F	T
	M3	7		

¹For more information on OIML Weight Classifications see page 240

²For more information on ASTM Weight Classification see page 242 (ASTM E617)

³Listed for reference only. NBS Cir. 547 has been superseded by ASTM E 617 classifications

NOTE: All NIST Class F 2020 are acceptable as NIST Class F providing they meet the criteria defined in NIST Handbook 105-1 2019

Precision Mass Reference Standards and Calibration Weights

Accuracy Classes, NIST Handbook 44



Class	Value of the Verification Scale Division (d or e ¹)	Number of Scale ⁴ Divisions (n)	
		Minimum	Maximum
SI Units			
I	Equal to or greater than 1 mg	50,000	-
II	1 to 50 mg, inclusive	100	100,000
	Equal to or greater than 100 mg	5,000	100,000
III ^{2,5}	0.1 to 2 g, inclusive	100	10,000
	Equal to or greater than 5 g	500	10,000
III L ³	Equal to or greater than 2 kg	2,000	10,000
IIII	Equal to or greater than 5 g	100	1,200
U.S. Customary Units			
III ⁵	0.0002 to 0.005 lb, inclusive	100	10,000
	0.005 to 0.125 oz inclusive	100	10,000
	Equal to or greater than 0.01 lb	500	10,000
	Equal to or greater than 0.25 oz	500	10,000
III L ³	Equal to or greater than 5 lb	2,000	10,000
IIII	Greater than 0.01 lb	100	1,200
	Greater than 0.25 oz	100	1,200

Table 3 - Parameters for Accuracy Classes - Handbook 44

¹ For Class I and II devices equipped with auxiliary reading means (i.e., a rider, a vernier, or a least significant decimal differentiated by size, shape, or color), the value of the verification scale division "e" is the value of the scale division immediately preceding the auxiliary means.

² A Class III scale marked "For prescription weighing only" may have a verification scale division (e) not less than 0.01g. (Added 1986) (Amended 2003)

³ The value of a scale division for crane and hopper (other than grain hopper) scales shall be not less than 0.2kg (0.5lb). The minimum number of scale divisions shall be not less than 1,000.

⁴ On a multiple range or multi-interval scale, the number of divisions for each range independently shall not exceed the maximum specified for the accuracy class. The number of scale divisions, n, for each weighing range is determined by dividing the scale capacity for each range by the verification scale division, e, for each range. On a scale system with multiple load receiving elements and multiple indications, each element considered shall not independently exceed the maximum specified for the accuracy class. If the system has a summing indicator, the nmax for the summed indication shall not exceed the maximum specified for the accuracy class. (Added 1997)

⁵ The minimum number of scale divisions for a Class III hopper scale used for weighing grain shall be 2,000. [Nonretroactive as of January 1, 1986] (Amended 1986, 1987, 1997, 1998, 1999, 2003, and 2004)

Weight Classification, International Laboratory Weights and Precision Mass Standards

OIML Weight Classification and Selection

OIML is a worldwide, intergovernmental organization whose primary aim is to harmonize the regulations and metrological controls applied by national metrological services, or related organizations of member states.

The two main categories of OIML publications are:

- International Recommendations (OIML R), which are model regulations that establish the metrological characteristics required of certain measuring instruments and which specify methods and equipment for checking their conformity; the OIML member states shall implement these recommendations to the greatest possible extent.
- International Documents (OIML D), which are informative in nature and intended to improve the work of metrological services.
- International Recommendations and International Documents are published in French (F) and English (E), and are subject to revision.
- OIML publications may be obtained from the organization's headquarters:

Bureau International de Metrologie Legale 11
 Rue Turgot - 75009 Paris France
 Telephone: 33 (1) 48 78 12 82 and 42 85 27 11
 Fax: 33 (1) 42 82 17 27
 Telex: 234 444 SVP SERV F ATTN. OIML
 www.OIML.org

General Information on Weight Classes: E1, E2, F1, F2, M1, M2

This recommendation contains the principle physical characteristics and metrological requirements for weights which are used:

- For the verification of weighing instruments.
- For the verification of weights of a lower class of accuracy.

The nominal values of mass of the weights covered by this recommendation range from 1 milligram (mg) to 50 kilograms (kg).

This recommendation applies to weights in classes of accuracy as follows: E1, E2, F1, F2, M1, M2 and M3.

Weights used for the verification of weighing instruments

The classes of accuracy of the weights used for the verification of weighing instruments shall be specified in the appropriate International Recommendations relating to these instruments.

Weights used for the verification of weights of a lower class of accuracy

- E1 Weights intended to ensure traceability between national mass standards (with values derived from the International Prototype of the kilogram. The kilogram, symbol kg, is the SI unit of mass. It is defined by taking the fixed numerical value of the Planck constant h to be $6.626\,070\,15 \times 10^{-34}$ when expressed in the unit J s, which is equal to $\text{kg m}^2 \text{s}^{-1}$, where the metre and the second are defined in terms of c and $\Delta \nu_{\text{Cs}}$) and weights of Class E2 and lower. Class E1 weights or sets of weights shall always be accompanied by a calibration certificate.
- E2 Weights intended to be used for the initial verification of weights of Class F1. They may be used as Class E1 weights if they comply with the requirements for surface roughness and magnetic susceptibility of Class E1 weights and if their calibration certificate gives the appropriate data.
- F1 Weights intended to be used for the initial verification of weights of Class F2.
- F2 Weights intended to be used for the initial verification of weights of Class M1 and possibly M2. M1 weights intended to be used for the initial verification of weights of Class M2.
- F1, F2 Weights used with instruments of accuracy Class I.
- F2 Weights intended to be used for important commercial transactions (e.g. gold and precious stones) on weighing instruments of accuracy Class II.
- M1 Weights intended to be used with weighing instruments of accuracy Class II.
- M2 Weights intended to be used in normal commercial transactions and on weighing instruments of accuracy Class III.
- M3 Weights intended to be used on weighing instruments of accuracy Classes III and IV.

The accuracy of weights used with weighing instruments shall be chosen in accordance with the requirements of OIML R 76 "Nonautomatic weighing instruments."

Excerpts from the Standard Specification for Laboratory Weights and Precision Mass Standards as Regulated by the Organization Internationale De Metrologie Legale (OIML): 2004 Edition (E) Publication OIML R 111-1

This specification covers various classes of weights and mass standards used in laboratories, and weights used for field standards and commercial measurement.

Construction

Class E1 and E2 Weights

Class E1 and E2 weights shall be solid and have no cavity open to the atmosphere. They shall have an integral construction, i.e., consist of a single piece of material.

Class F1 and F2 Weights

Class F1 and F2 weights from 1 gram to 50 kilograms may be one or more pieces from the same material. Class F1 and F2 weights may contain an adjusting cavity; however, the volume of this cavity shall not exceed one-twentieth of the total volume of the weight, and the cavity shall be closed either by means of the lifting knob or by any other suitable device.

Calibration or Initial Verification

Certain categories of new weights may either be calibrated individually or be subject to initial verification, depending on their intended use and the national legislation of the country.

Calibration weights shall be accompanied by a certificate which gives at least the conventional mass of each weight, its expanded uncertainty and the value of the coverage factor k (see coverage factor k).

Class E1 weights shall always be accompanied by certificates.

The certificate for Class E1 weights shall mention at least the values of conventional mass, the expanded uncertainty and the coverage factor k , and the density or volume for each weight.

The optional certificate for Class E2 weights shall mention at least:

- The values of conventional mass of each weight and the expanded uncertainty and the coverage factor k , or
- The information required for Class E1 weights certificates (under the conditions of the above paragraph).

Recalibration or Periodic Verification

The categories of weights which are subject to calibration or initial verification should either be recalibrated or have a periodic verification. This makes it possible to verify that the weights maintain their metrological properties. Any weights found defective at the time of the periodic verification shall be discarded or readjusted.

Uncertainty of Measurement

Standard Uncertainty

Uncertainty of the result of a measurement expressed as an estimated standard deviation.

Combined Standard Uncertainty

Standard uncertainty of a measurement result. When that result is obtained from the values of a number of quantities, it is equal to the positive square root of the appropriate sum of the variances and covariances of these quantities. The variance of quantity is the square of its standard deviation.

Expanded Uncertainty

The expanded uncertainty U is obtained by multiplying the combined standard uncertainty by the coverage factor k . $U = k \cdot u_c$

Coverage factor k — level of confidence

In most cases, it is appropriate to use the factor $k = 2$.

For the normal distribution, the factor $k = 2$ signifies that the limits of expanded uncertainty apply when the confidence level is approximately 95.45%.

Excerpts from the Standard Specification for Laboratory Weights and Precision Mass Standards as Regulated by the Organization Interna- tionale De Metrologie Legale (OIML): 2004 Edition (E) Publication OIML R 111-1

This specification covers various classes of weights and mass standards used in laboratories, and weights used for field standards and commercial measurement.

Weight Classification, U.S. Laboratory Weights and Precision Mass Standards



Weight Classification and Selection

Selection of type and class depends upon the application of the weights. For primary standards, stability and information about the values of the weights is more important than the closeness of the values to nominal. Weights to be used with balances of low precision do not require small tolerances nor need the choice of materials to be limited to those of high stability. The suggested application table should serve as a guide in selecting weights for specific applications.

Type

Weights are divided into two types based upon the design:

Type I

These weights are of one-piece construction and contain no added adjusting material. They should be specified when weights are to be used as standards of the highest order and where maximum stability is required. A precise measurement of density can be made only for one-piece weights.

Type II

Weights of this type can be of any appropriate design such as screw-knob, ring or sealed plug. Adjusting material can be used as long as it is of a material at least as stable as the base material and is contained in such a way that it will not become separated from the weight.

Physical Characteristics

Class 00 and 0 must be Type I, one-piece construction, and Classes 1–7 can be either Type I or II depending on the application. All weights must meet other design requirements for density, hardness, permitted surface area, surface finish, magnetic properties, corrosion resistance, surface protection and markings. Class selection depends upon the degree of stability required. Density limitations are important in minimizing the effects of air buoyancy in high precision measurements. Class 0 weights shall not bear any indication of nominal value.

Class

Tolerance limitations are described in Classes 00, 0, 1, 2, 3, 4, 5, 6 and 7 as shown in the weight tolerance tables. Classes with small numerical designations represent smaller tolerances. Classes 0, 1 and 2 are used primarily in metric but are also available in avoirdupois denominations. Classes 3, 4, 5, 6 and 7 include tolerances for metric, avoirdupois pound, avoirdupois ounce, troy ounce, pennyweight and grain weights. Class 1 through 7 tolerances are comparable to those in the obsolete NIST Circular 547, Section 1, with the following exception: Class 1 replaces the smaller tolerances of Classes M and S, while Class 2 replaces the larger tolerances of Classes M and S.

Excerpts from the Standard Specification for Laboratory Weights and Precision Mass Standards: ASTM E 617-18

This specification covers various classes of weights and mass standards used in laboratories, and weights used for field standards and commercial measurement are excluded, as NIST Handbook 105-1 and NIST Handbook 44 cover those classes of weights.





Application Table X1.1 ASTM E617-18

Class	Type	Application
0, 00 and 000	I	Primary laboratory reference standards
0	I	Reference standards used for calibrating Class 1 weights
0	I	Reference standards used for calibrating Class 2 weights
1	I	Reference standards used for calibrating Class 3 weights
1	II	Calibration weights used with calibration Class I balances
1	I or II	Built in weights for high quality analytical balances
1 and 2	I or II	Calibration weights used with calibration Class II balances, laboratory weights for routine analytical work
2	I or II	Standards used for calibrating Class 4 weights
3	I or II	Standards used for calibrating Class 5 weights
4	I or II	Standards used for calibrating Class 6 weights
4,5 and 6	I or II	Calibration weights used with Class III, IIII and IIII balances, dial scales, trip balances and platform scales
5 and 6	I or II	Student laboratory use
7	I or II	Rough weighing operations in physical and chemical laboratories such as force measuring apparatus

Term Abbreviations NIST Handbook 44, Appendix C

Units of Mass	
1 assay ton (AT)	29.167 grams
1 carat (c)	200 milligrams (exactly) / 3.086 grains
1 dram apothecaries (dr ap or ʒ)	60 grains (exactly) / 3.888 grams
1 dram avoirdupois (dr avdp)	27 11/32 (= 27.344) grains 1.772 grams
1 gamma (γ)	1 microgram (exactly)
1 grain (gr)	64.798 91 milligrams (exactly)
1 gram (g)	15.432 grains 0.035 ounce, avoirdupois
1 hundredweight, gross or long (gross cwt)	112 pounds (exactly) / 50.802 kilograms
1 hundredweight, gross or short (cwt or net cwt)	100 pounds (exactly) / 45.359 kilograms
1 kilogram (kg)	2.205 pounds
1 milligram (mg)	0.015 grain
1 ounce, avoirdupois (oz avdp)	437.5 grains (exactly) / 0.911 troy or apothecaries ounce / 28.350 grams
1 ounce, troy or apothecaries (oz t or oz ap or ʒ)	480 grains (exactly) / 1.097 avoirdupois ounces / 31.103 grams
1 pennyweight (dwt)	1.555 grams
1 point	0.01 carat / 2 milligrams
1 pound, avoirdupois (lb avdp)	7000 grains (exactly) / 1.215 troy or apothecaries pounds / 453.592 37 grams (exactly)
1 micropound (μlb) [the Greek letter mu in combination with the letters lb]	0.000 001 pound (exactly)
1 pound, troy or apothecaries (lb t or lb ap)	5760 grains (exactly) / 0.823 avoirdupois pound / 373.242 grams
1 scruple (s ap or ʒ)	20 grains (exactly) / 1.296 grams
1 ton, gross or long	2240 pounds (exactly) / 1.12 net tons (exactly) / 1.016 metric tons
1 ton, metric (t)	2204.623 pounds / 0.984 gross ton / 1.102 net tons
1 ton, net or short (tn) ²¹	2000 pounds (exactly) / 0.893 gross ton / 0.907 metric ton

Metric Weight Tolerances

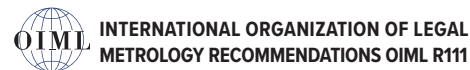

Tolerance for weights of denominations between those listed can be determined as follows:

- If the unit of measure is non-metric, convert the nominal value to a metric unit.
- For weights that are between those listed, the tolerance for the next lower weight shall be applied.

OIML R111-I 2004

Nominal Size	Class E1	Class E2	Class F1	Class F2	Class M1	Class M2	Class M3
	mg	mg	mg	mg	mg	mg	mg
5 000 kg			25,000	80,000	250,000	800,000	2,500,000
2 000 kg			10,000	30,000	100,000	300,000	1,000,000
1 000 kg		1,600	5,000	16,000	50,000	160,000	500,000
500 kg		800	2,500	8,000	25,000	80,000	250,000
200 kg		300	1,000	3,000	10,000	30,000	100,000
100 kg		160	500	1,600	5,000	16,000	50,000
50 kg	25	80	250	800	2,500	8,000	25,000
20 kg	10	30	100	300	1,000	3,000	10,000
10 kg	5.0	16	50	160	500	1,600	5,000
5 kg	2.5	8.0	25	80	250	800	2,500
2 kg	1.0	3.0	10	30	100	300	1,000
1 kg	0.5	1.6	5.0	16	50	160	500
500 g	0.25	0.8	2.5	8.0	25	80	250
200 g	0.1	0.3	1.0	3.0	10	30	100
100 g	0.05	0.16	0.5	1.6	5.0	16	50
50 g	0.03	0.10	0.3	1.0	3.0	10	30
20 g	0.025	0.08	0.25	0.8	2.5	8.0	25
10 g	0.020	0.06	0.20	0.6	2.0	6.0	20
5 g	0.016	0.05	0.16	0.5	1.6	5.0	16
2 g	0.012	0.04	0.12	0.4	1.2	4.0	12
1 g	0.010	0.03	0.10	0.3	1.0	3.0	10
500 mg	0.008	0.025	0.08	0.25	0.8	2.5	
200 mg	0.006	0.020	0.06	0.20	0.6	2.0	
100 mg	0.005	0.016	0.05	0.16	0.5	1.6	
50 mg	0.004	0.012	0.04	0.12	0.4		
20 mg	0.003	0.010	0.03	0.10	0.3		
10 mg	0.003	0.008	0.025	0.08	0.25		
5 mg	0.003	0.006	0.020	0.06	0.20		
2 mg	0.003	0.006	0.020	0.06	0.20		
1 mg	0.003	0.006	0.020	0.06	0.20		

**Reprinted, with permission from the Annual Book of ASTM Standards, Copyright American Society for Testing and Materials, 100 Barr Harbor Drive, West Conshohocken, PA 19428. Reprinted OIML R111-I:2004(E)*

Weight Classification, U.S. Field Standard



Specification and Tolerances for Field Standard Weights (NIST Handbook 105-1, Class F, Revised 2019)

These specifications and tolerances are minimum requirements for standards used primarily to test weighing devices.

Introduction

A Class F field standard weight (after this, called “weight”) is intended to be used primarily to test commercial weighing devices for compliance with the requirements of NIST Handbook 44. Class F weights may be used to test most accuracy Class 2 III scales, all scales of Class III or IV, and scales not marked with a class designation.

A weight shall be verified to be within tolerance prior to use. The within-tolerance status of a weight shall be rechecked as often as regulations or circumstances require, especially when damage to it is known or suspected.

General

These specifications apply to new weights placed in service after the publication of this standard; the tolerances apply to all weights in service.

A weight in service prior to the publication of this standard that has maintained Class F tolerances between verification tests shall continue to be acceptable.

The specifications permit the use of a weight at its nominal value in normal testing operations, where the tolerance on the item under test is at least three times as great as the tolerance of the weight.

NIST Handbook 44, Specifications Tolerances, and Other Technical Requirements for Weighing and Measuring Devices. (See current edition.) See Handbook 44, Section 2, Scales Code. See Handbook 44, Appendix A, par. 3.2.

A partial list of specifications from Handbook 105-1

1. Material

- 1.1 A weight made of brass or a fabricated weight (such as a laminated weight or a weight of nonuniform density) shall not be placed in service after the publication date of this standard (1990).
- 1.2 A weight smaller than 5 grams/0.01 pound shall be constructed of stainless steel, tantalum, nickel-chromium alloy aluminum alloy, or other material sufficiently resistant to corrosion and oxidation that the surface need not be protected or coated.
- 1.3 A weight of 5 grams/0.01 pound up to and including 5 kilogram/10 pound shall be constructed of material having a hardness of Rockwell B 80 or greater (such as 300-series stainless steel), and be resistant to abrasion, corrosion, denting and chipping.
- 1.4 A weight larger than 5 kilograms/10 pounds shall be constructed of

materials such as iron, steel or stainless steel, have a hardness of Rockwell B 80 or greater, and be resistant to abrasion, corrosion, denting and chipping. Cast iron may be used for weights 10 kilograms/20 pound and larger. Body filler (e.g., fiberglass, putty or plaster) shall not be used to correct a poor casting or finish.

2. Finish

- 2.1 The surface finish of a new weight machined from round bar stock shall have a roughness average of 0.80 micrometers (32 microinches) or better, determined by use of a handheld surface roughness indicator (available from several manufacturers) or more accurate method, and be free of scratches, dents, and chipped corners or edges, determined by visual examination. A beaded or blasted finish (with roughness average 1.25 micrometers (50 microinches) or better) is acceptable on a cube weight to facilitate gripping.
- 2.2 A weight 5 kilograms/10 pounds or less shall not have a surface coating.
- 2.3 A weight larger than 5 kilograms/10 pounds constructed of materials susceptible to corrosion or tarnishing shall have a protective surface coating. A light coat of sprayed-on flat aluminum paint is recommended. Lacquer is also acceptable. Epoxy paint or plated surfaces are not acceptable. A coating is recommended for the bottom of a weight, particularly if the bottom is recessed. If paint or lacquer is used, it shall be hard and resistant to chipping. Cast metric and avoirdupois field standards shall be color coded (i.e. gold for metric and silver for avoirdupois) to differentiate the weights.
- 2.4 The surface finish of a cast weight shall have a roughness average of between 12.5 and 25 micrometers (50 and 1,000 microinches), determined by use of a handheld surface roughness indicator or more accurate method, and be free of sharp surface irregularities such as scabbing (as defined in ASTM A 025), visible cracks or holes which affect the surface finish average. Surface imperfections corrected by machining or welding are acceptable.
- 2.5 For a cast weight with a pipe handle, the casting near the handle must not be heavily cracked; the visible space between the handle and casting shall be as small as possible, consistent with good manufacturing practices. For cast weight with a handle welded in place, the welded seam shall be continuous and show not obvious air holes or cracks as determined by a visual examination.
- 2.6 Plating or coating shall not be used on a sheet metal type weight.

Weight Tolerance, Metric



Nominal Size	Class 000	Class 00	Class 0	Class 1	Class 2	Class 3	Class 4	Class 5	Class 6	Class 7
	mg	mg	mg	mg	g and mg	g and mg	g and mg	g and mg	g and mg	g and mg
5 000 kg					25 g	50 g	100 g	250 g	500 g	750 g
3 000 kg					15 g	30 g	60 g	150 g	300 g	450 g
2 000 kg					10 g	20 g	40 g	100 g	200 g	300 g
1 000 kg					5.0 g	10 g	20 g	50 g	100 g	150 g
500 kg					2.5 g	5.0 g	10 g	25 g	50 g	75 g
300 kg					1.5 g	3.0 g	6.0 g	15 g	30 g	45 g
200 kg					1.0 g	2.0 g	4.0 g	10 g	20 g	30 g
100 kg					500 mg	1.0 g	2.0 g	5.0 g	10 g	15 g
50 kg	13 mg	25 mg	63 mg	120 mg	250	500 mg	1.0 g	2.5 g	5.0 g	7.5 g
30 kg	7.5	15	38	75	150	300	600 mg	1.5 g	3.0 g	4.5 g
25 kg	6.25	12.5	31	62	125	250	500	1.2 g	2.5 g	3.8 g
20 kg	5.0	10	25	50	100	200	400	1.0 g	2.0 g	3.8 g
10 kg	2.5	5.0	13	25	50	100	200	500 mg	1.0 g	2.2 g
5 kg	1.3	2.5	6.0	12	25	50	100	250	500 mg	1.4 g
3 kg	0.75	1.5	3.8	7.5	15	30	60	150	300	1.0 g
2 kg	0.5	1.0	2.5	5.0	10	20	40	100	200	750 mg
1 kg	0.25	0.5	1.3	2.5	5.0	10	20	50	100	470
500 g	0.13	0.25	0.60	1.2	2.5	5.0	10	30	50	300
300 g	0.075	0.15	0.38	0.75	1.5	3.0	6.0	20	30	210
200 g	0.05	0.10	0.25	0.50	1.0	2.0	4.0	15	20	160
100 g	0.025	0.05	0.13	0.25	0.50	1.0	2.0	9.0	10	100
50 g	0.015	0.030	0.060	0.12	0.25	0.60	1.2	5.6	7.0	62
30 g	0.014	0.026	0.037	0.074	0.15	0.45	0.90	4.0	5.0	44
20 g	0.013	0.025	0.037	0.074	0.10	0.35	0.70	3.0	3.0	33
10 g	0.010	0.020	0.025	0.050	0.074	0.25	0.50	2.0	2.0	21
5 g	0.005	0.010	0.017	0.034	0.054	0.18	0.36	1.3	2.0	13
3 g	0.005	0.010	0.017	0.034	0.054	0.15	0.30	0.95	2.0	9.4
2 g	0.005	0.010	0.017	0.034	0.054	0.13	0.26	0.75	2.0	7.0
1 g	0.005	0.010	0.017	0.034	0.054	0.10	0.20	0.50	2.0	4.5
500 mg	0.002	0.003	0.005	0.010	0.025	0.080	0.16	0.38	1.0	3.0
300 mg	0.002	0.003	0.005	0.010	0.025	0.070	0.14	0.30	1.0	2.2
200 mg	0.002	0.003	0.005	0.010	0.025	0.060	0.12	0.26	1.0	1.8
100 mg	0.002	0.003	0.005	0.010	0.025	0.050	0.10	0.20	1.0	1.2
50 mg	0.002	0.003	0.005	0.010	0.014	0.042	0.085	0.16		0.88
30 mg	0.002	0.003	0.005	0.010	0.014	0.038	0.075	0.14		0.68
20 mg	0.002	0.003	0.005	0.010	0.014	0.035	0.070	0.12		0.56
10 mg	0.002	0.003	0.005	0.010	0.014	0.030	0.060	0.10		0.40
5 mg	0.002	0.003	0.005	0.010	0.014	0.028	0.055	0.080		
3 mg	0.002	0.003	0.005	0.010	0.014	0.026	0.052	0.070		
2 mg	0.002	0.003	0.005	0.010	0.014	0.025	0.050	0.060		
1 mg	0.002	0.003	0.005	0.010	0.014	0.025	0.050	0.050		
0.5 mg	0.002	0.003	0.005	0.010	0.014	0.025	0.050	0.050		
0.3 mg	0.002	0.003	0.005	0.010	0.014	0.025				
0.2 mg	0.002	0.003	0.005	0.010	0.014					
0.1 mg	0.002	0.003	0.005	0.010						
0.05 mg	0.002	0.003	0.005	0.010						

*Reprinted, with permission from the Annual Book of ASTM Standards, Copyright American Society for Testing and Materials, 100 Barr Harbor Drive, West Conshohocken, PA 19428. Reprinted OIML R111-I:2004(E)

Weight Tolerance, Avoirdupois



Nominal Size	Class 0	Class 1	Class 2	Class 3	Class 4	Class 5	Class 6	Class 7
	mg	mg	mg	g and mg	g and mg	g and mg	g and mg	g and mg
10 000 lb				45 g	91 g	230 g	450 g	680 g
5 000 lb				23 g	45 g	110 g	230 g	340 g
3 000 lb				14 g	27 g	68 g	140 g	200 g
2 500 lb				11 g	23 g	57 g	110 g	170 g
2 000 lb				9.1 g	18 g	45 g	91 g	140 g
1 000 lb				4.5 g	9.1 g	23 g	45 g	68 g
500 lb				2.3 g	4.5 g	11 g	23 g	34 g
300 lb				1.4 g	2.7 g	6.8 g	14 g	20 g
200 lb				910 mg	1.8 g	4.5 g	9.1 g	14 g
100 lb	57	110	230	450	910 mg	2.3 g	4.5 g	6.8 g
50 lb	29	57	110	230	450	1.1 g	2.3 g	4.1 g
30 lb	17	32	68	140	270	680 mg	1.4 g	2.7 g
25 lb	14	28	57	110	230	570	1.1 g	2.4 g
20 lb	12	23	45	91	180	450	910 mg	2.0 g
10 lb	5.5	11	23	45	91	230	450	1.3 g
5 lb	2.7	5.4	11	23	45	110	230	780 mg
3 lb	1.7	3.4	6.8	14	27	68	140	580
2 lb	1.2	2.3	4.5	9.1	18	45	91	440
1 lb	0.55	1.1	2.3	4.5	9.1	23	45	270
0.5 lb	0.27	0.54	1.1	2.3	4.5	16	23	170
0.3 lb	0.17	0.34	0.68	1.4	2.7	11	14	120
0.2 lb	0.12	0.23	0.45	0.91	1.8	8.2	9.1	97
0.1 lb	0.055	0.11	0.23	0.45	1.1	5.4	6.8	59
0.05 lb	0.027	0.054	0.11	0.36	0.77	3.3	4.5	37
0.03 lb	0.017	0.034	0.068	0.32	0.59	2.4	3.2	26
0.02 lb	0.017	0.034	0.045	0.23	0.45	1.9	2.3	20
0.01 lb	0.012	0.023	0.034	0.16	0.34	1.2	1.4	12
0.005 lb	0.0075	0.015	0.024	0.14	0.27	0.86	0.91	7.8
0.003 lb	0.0075	0.015	0.024	0.11	0.22	0.64	0.91	5.4
0.002 lb	0.0075	0.015	0.024	0.091	0.19	0.50	0.91	4.2
0.001 lb	0.0075	0.015	0.024	0.068	0.15	0.36	0.91	2.9
0.0005 lb	0.0045	0.0091	0.023	0.064	0.13	0.27		2.1
0.0003 lb	0.0045	0.0091	0.023	0.054	0.11	0.23		1.5
0.0002 lb	0.0045	0.0091	0.023	0.045	0.095	0.20		1.2
0.0001 lb	0.0045	0.0091	0.023	0.041	0.086	0.16		0.84

*Reprinted, with permission from the Annual Book of ASTM Standards, Copyright American Society for Testing and Materials, 100 Barr Harbor Drive, West Conshohocken, PA 19428. Reprinted OIML R111-I:2004(E)

Weight Tolerance, Avoirdupois Ounces



Nominal Size	Class 0	Class 1	Class 2	Class 3	Class 4	Class 5	Class 6	Class 7
	mg	mg	mg	mg	mg	mg	mg	mg
10 oz	0.35	0.70	1.4	2.8	5.4	19	23	200
8 oz	0.27	0.54	1.1	2.3	4.5	16	23	170
5 oz	0.18	0.35	0.71	1.4	2.8	12	11	130
4 oz	0.14	0.28	0.57	1.1	2.3	9.5	11	110
3 oz	0.10	0.21	0.43	0.91	1.8	8.2	5.4	
2 oz	0.070	0.14	0.28	0.64	1.3	5.9	5.4	70
1 oz	0.027	0.054	0.14	0.43	0.86	3.9	3.2	42
1/2 oz	0.017	0.034	0.071	0.30	0.59	2.5	2.3	27
1/4 oz	0.011	0.023	0.034	0.20	0.43	1.6	1.4	17
1/8 oz	0.0075	0.015	0.024	0.16	0.31	1.1	0.91	10
1/16 oz	0.0075	0.015	0.024	0.12	0.24	0.73	0.91	6.5
1/32 oz	0.0075	0.015	0.024	0.095	0.19	0.50		4.2
1/64 oz	0.0075	0.015	0.023	0.077	0.15	0.36		2.8

*Reprinted, with permission from the Annual Book of ASTM Standards, Copyright American Society for Testing and Materials, 100 Barr Harbor Drive, West Conshohocken, PA 19428. Reprinted OIML R111-1:2004(E)

Weight Tolerance, Troy Ounces



Nominal Size	Class 000	Class 00	Class 0	Class 1	Class 2	Class 3	Class 4	Class 5	Class 6	Class 7
						mg	mg	g and mg		
1000 oz t						310	620	1.6 g		
500 oz t						160	310	780 mg		
300 oz t						91	190	470		
200 oz t						62	120	310		
100 oz t						31	62	160		
50 oz t						16	31	78		
30 oz t						9.1	19	47		
20 oz t						6.2	12	35		
10 oz t						3.1	6.2	21		
5 oz t						1.6	3.1	12		
3 oz t						0.91	1.9	8.4		
2 oz t						0.71	1.4	6.5		
1 oz t						0.45	0.91	4.2		
0.5 oz t						0.31	0.62	2.6		
0.3 oz t						0.24	0.49	1.5		
0.2 oz t						0.20	0.40	0.97		
0.1 oz t						0.15	0.30	0.97		
0.05 oz t						0.12	0.23	0.65		
0.03 oz t						0.097	0.19	0.49		
0.02 oz t						0.084	0.17	0.41		
0.01 oz t						0.071	0.14	0.31		
0.005 oz t						0.056	0.11	0.23		
0.003 oz t						0.049	0.097	0.19		
0.002 oz t						0.044	0.091	0.17		
0.001 oz t						0.038	0.078	0.14		
0.0005 oz t						0.033	0.065	0.11		
0.0003 oz t						0.030	0.060	0.097		
0.0002 oz t						0.028	0.056	0.084		
0.0001 oz t						0.026	0.052	0.071		

*Reprinted, with permission from the Annual Book of ASTM Standards, Copyright American Society for Testing and Materials, 100 Barr Harbor Drive, West Conshohocken, PA 19428. Reprinted OIML R111-I:2004(E)

Weight Tolerance, Pennyweight and Grain



Nominal Size	Class 0	Class 1	Class 2	Class 3	Class 4	Class 5	Class 6	Class 7
				mg	g and mg	g and mg		
10,000 dwt				155	0.31g	0.78 g		
5,000 dwt				78	0.16 g	0.39		
3,000 dwt				47	91mg	0.23		
2,000 dwt				31	62	0.16		
1,000 dwt				16	31	78 mg		
500 dwt				7.8	16	41		
300 dwt				4.7	9.1	28		
200 dwt				3.1	6.2	21		
100 dwt				1.6	3.1	12		
50 dwt				0.78	1.6	7.8		
30 dwt				0.58	1.2	5.3		
20 dwt				0.46	0.91	4.2		
10 dwt				0.31	0.62	2.6		
5 dwt				0.22	0.44	1.7		
3 dwt				0.17	0.34	1.3		
2 dwt				0.15	0.3	0.97		
1 dwt				0.12	0.23	0.65		

Nominal Size	Class 0	Class 1	Class 2	Class 3	Class 4	Class 5	Class 6	Class 7
				mg	mg	mg	mg	
10,000 gr				6.5	13	36	64	
5,000 gr				3.2	6.5	22	32	
3,000 gr				1.9	3.9	15	020	
2,000 gr				1.3	2.6	11	14	
1,000 gr				0.71	1.4	6.3	6.4	
500 gr				0.48	0.91	3.2	3.2	
300 gr				0.358	0.65	2.3	2.3	
200 gr				0.28	0.57	1.4	1.4	
100 gr				0.20	0.4	0.91	0.91	
50 gr				0.15	0.3	0.91	0.91	
30 gr				0.12	0.25	0.71	0.91	
20 gr				0.11	0.21	0.58	0.91	
10 gr				0.084	0.17	0.42	0.91	
5 gr				0.071	0.14	0.31	0.45	
3 gr				0.060	0.12	0.25	0.45	
2 gr				0.054	0.11	0.22	0.45	
1 gr				0.045	0.091	0.17	0.45	
0.5 gr				0.039	0.078	0.14	0.45	
0.3 gr				0.035	0.071	0.12		
0.2 gr				0.032	0.064	0.11		
0.1 gr				0.028	0.056	0.091		
0.05 gr				0.026	0.052	0.071		
0.03 gr				0.025	0.051	0.071		
0.02 gr				0.025	0.05	0.071		
0.01 gr				0.025	0.05	0.071		

*Reprinted, with permission from the Annual Book of ASTM Standards, Copyright American Society for Testing and Materials, 100 Barr Harbor Drive, West Conshohocken, PA 19428. Reprinted OIML R111-1:2004(E)

Weight Tolerance, Carats, Apothecary Scruples



Nominal Size	Class 0	Class 1	Class 2	Class 3	Class 4	Class 5	Class 6	Class 7
				mg	mg		mg	
5 000 c				10	20			
3 000 c				6.0	12			
2 000 c				4.0	8.0			
1 000 c				2.0	4.0			
500 c				1.0	2.0			
300 c				0.69	1.3			
200 c				0.52	1.0			
100 c				0.35	0.7			
50 c				0.25	0.50			
30 c				0.19	0.40			
20 c				0.16	0.33			
10 c				0.13	0.26			
5 c				0.10	0.20			
3 c				0.086	0.17			
2 c				0.075	0.15			
1 c				0.060	0.12			
0.5 c				0.050	0.10			
0.3 c				0.044	0.089			
0.2 c				0.040	0.080			
0.1 c				0.035	0.070			
0.05 c				0.030	0.060			
0.03 c				0.028	0.056			
0.02 c				0.027	0.053			
0.01 c				0.025	0.050			
Apothecary Ounce								
12 oz ap							45	
10 oz ap							36	
6 oz ap							23	
5 oz ap							18	
4 oz ap							16	
3 oz ap							11	
2 oz ap							9.1	
1 oz ap							4.5	
Apothecary Dram								
6 dr ap							3.6	
5 dr ap							2.7	
4 dr ap							2.3	
3 dr ap							1.8	
2 dr ap							1.8	
1 dr ap							1.4	
Apothecary Scruple								
2 s ap							1.4	
1 s ap							0.91	

*Reprinted, with permission from the Annual Book of ASTM Standards, Copyright American Society for Testing and Materials, 100 Barr Harbor Drive, West Conshohocken, PA 19428. Reprinted OIML R111-I:2004(E)

Weight Tolerances for Historical NIST Handbook 105-1 (1990)



NIST Class F

Tolerances are based on NIST Handbook 105-1 (1990)

Metric

Nominal Value	105-1
	Class F g and mg
500 kg	50 g
300 kg	30 g
200 kg	20 g
100 kg	10 g
50 kg	5.0 g
30 kg	3.0 g
20 kg	2.0 g
10 kg	1.0 g
5 kg	0.50 g
3 kg	0.30 g
2 kg	0.20 g
1 kg	0.10 g
500 g	70 mg
300 g	60 mg
200 g	40 mg
100 g	20 mg
50 g	10 mg
30 g	6.0 mg
20 g	4.0 mg
10 g	2.0 mg
5 g	1.5 mg
3 g	1.3 mg
2 g	1.1 mg
1 g	0.90 mg
500 mg	0.72 mg
300 mg	0.61 mg
200 mg	0.54 mg
100 mg	0.43 mg
50 mg	0.35 mg
30 mg	0.30 mg
20 mg	0.26 mg
10 mg	0.21 mg
5 mg	0.17 mg
3 mg	0.14 mg
2 mg	0.12 mg
1 mg	0.10 mg

Avoirdupois Pounds

Nominal Value	105-1
	Class F g and mg
10,000 lb	450 g
5,000 lb	230 g
3,000 lb	140 g
2,500 lb	110 g
2,000 lb	91 g
1,000 lb	45 g
500 lb	23 g
100 lb	4.5 g
50 lb	2.3 g
30 lb	1.4 g
25 lb	1.1 g
20 lb	0.91 g
10 lb	0.45 g
5 lb	230 mg
3 lb	140 mg
2 lb	91 mg
1 lb	70 mg
0.5 lb	45 mg
0.3 lb	27 mg
0.2 lb	18 mg
0.1 lb	9.1 mg
0.05 lb	4.5 mg
0.03 lb	2.7 mg
0.02 lb	1.8 mg
0.01 lb	1.5 mg
0.005 lb	1.2 mg
0.003 lb	0.99 mg
0.002 lb	0.87 mg
0.001 lb	0.70 mg

Avoirdupois Ounces

Nominal Value	105-1
	Class F mg
8 oz	45 mg
4 oz	23 mg
2 oz	11 mg
1 oz	5.4 mg
0.5 (1/2) oz	2.8 mg
0.3 oz	1.8 mg
0.25 (1/4) oz	1.7 mg
0.2 oz	1.6 mg
0.125 (1/8) oz	1.3 mg
0.1 oz	1.3 mg
0.0625 (1/16) oz	1.1 mg
0.05 oz	1.0 mg
0.03125 (1/32) oz	0.87 mg
0.03 oz	0.85 mg
0.02 oz	0.75 mg
0.012325 (1/64) oz	0.69 mg
0.01 oz	0.60 mg

Conversion Factors for Units of Measure

To convert one unit of measure to another, use our online weight conversion tool located with our resources found at www.ricelake.com/resources

Units of Mass Not Greater Than Pounds and Kilograms

(All Underlined Figures Are Exact) Multiply by the Conversion Factor Below the Ending

Units	Grains	Apothecaries Scruples	Pennyweights	Avoirdupois Drams	Apothecaries Drams	Avoirdupois Ounces
1 grain =	<u>1</u>	<u>0.05</u>	0.041 666 67	0.036 571 43	0.016 666 67	0.002 285 714
1 apoth. scruple =	<u>20</u>	<u>1</u>	0.833 333 3	0.731 428 6	0.333 333 3	0.045 714 29
1 pennyweight =	<u>24</u>	<u>1.2</u>	<u>1</u>	0.877 714 3	<u>0.4</u>	0.054 857 14
1 avdp. dram =	<u>27.343 75</u>	<u>1.367 187 5</u>	1.139 323	<u>1</u>	0.455 729 2	<u>0.062 5</u>
1 apoth. dram =	<u>60</u>	<u>3</u>	<u>2.5</u>	2.194 286	<u>1</u>	0.137 142 9
1 avdp. ounce =	<u>437.5</u>	<u>21.875</u>	18.229 17	<u>16</u>	7.291 667	<u>1</u>
1 apoth. or troy oz. =	<u>480</u>	<u>24</u>	<u>20</u>	17.554 29	<u>8</u>	1.097 143
1 apoth. or troy pound =	<u>5 760</u>	<u>288</u>	<u>240</u>	210.651 4	<u>96</u>	13.165 71
1 avdp. pound =	<u>7 000</u>	350	291.666 7	<u>256</u>	116.666 7	<u>16</u>
1 milligram =	0.015 432 36	0.000 771 617 9	0.000 643 014 9	0.000 564 383 4	0.000 257 206 0	0.000 035 273 96
1 gram =	15.432 36	0.771 617 9	0.643 014 9	0.564 383 4	0.257 206 0	0.035 273 96
1 kilogram =	15432.36	771.617 9	643.014 9	564.383 4	257.206 0	35.273 96

Units	Apothecaries or Troy Ounces	Apothecaries or Troy Pounds	Avoirdupois Pounds	Milligrams	Grams	Kilograms
1 grain =	0.002 083 333	0.000 173 611 1	0.000 142 857 1	<u>64.798 91</u>	<u>0.064 798 91</u>	<u>0.000 064 798 91</u>
1 apoth. scruple =	0.041 666 67	0.003 472 222	0.002 857 143	<u>1 295.978 2</u>	<u>1.295 978 2</u>	<u>0.001 295 978 2</u>
1 pennyweight =	<u>0.05</u>	0.004 166 667	0.003 428 571	<u>1 555.173 84</u>	<u>1.555 173 84</u>	<u>0.001 555 173 84</u>
1 avdp. dram =	0.56 966 15	0.004 747 179	0.003 906 25	<u>1 771.845 195</u> <u>312 5</u>	<u>1.771 845 195 312 5</u>	<u>0.001 771 845 195 312 5</u>
1 apoth. dram =	<u>0.125</u>	0.010 416 67	0.008 571 429	<u>3 887.934 6</u>	<u>3.887 934 6</u>	<u>0.003 887 934 6</u>
1 avdp. ounce =	0.911 458 3	0.075 954 86	<u>0.062 5</u>	<u>28 349.523 125</u>	<u>28.349 523 125</u>	<u>0.028 349 523 125</u>
1 apoth. or troy ounce =	<u>1</u>	0.083 333 333	0.068 571 43	<u>31 103.476 8</u>	<u>31.103 476 8</u>	<u>0.031 103 476 8</u>
1 apoth. or troy pound =	<u>12</u>	<u>1</u>	0.822 857 1	<u>373 241.721 6</u>	<u>373.241 721 6</u>	<u>0.373 241 721 6</u>
1 avdp. pound =	14.583 33	1.215 278	<u>1</u>	<u>453 592.37</u>	<u>453.592 37</u>	<u>0.453 592 37</u>
1 milligram =	0.000 032 150 75	0.000 002 679 229	0.000 002 204 623	<u>1</u>	<u>0.001</u>	<u>0.000 001</u>
1 gram =	0.032 150 75	0.002 679 229	0.002 204 623	<u>1 000</u>	<u>1</u>	<u>0.001</u>
1 kilogram =	32.150 75	2.679 229	2.204 623	<u>1 000 000</u>	<u>1 000</u>	<u>1</u>

Units	Avoirdupois Ounces	Avoirdupois Pounds	Short Hundred- Weights	Short Tons	Long Tons	Kilograms	Metric Tons
1 avoirdupois ounce =	<u>1</u>	<u>0.0625</u>	<u>0.000 625</u>	<u>0.000 031 25</u>	0.000 027 901 79	<u>0.028 349 523 125</u>	<u>0.000 028 349 523 125</u>
1 avoirdupois pound =	<u>16</u>	<u>1</u>	<u>0.01</u>	<u>0.000 5</u>	0.000 446 428 6	<u>0.453 592 37</u>	<u>0.000 453 592 37</u>
1 short hundredweight =	<u>1 600</u>	<u>100</u>	<u>1</u>	<u>0.05</u>	0.044 642 86	<u>45.359 237</u>	<u>0.045 359 237</u>
1 short ton =	<u>32 000</u>	<u>2 000</u>	<u>20</u>	<u>1</u>	0.892 857 1	<u>907.184 74</u>	<u>0.907 184 74</u>
1 long ton =	<u>35 840</u>	<u>2 240</u>	<u>22.4</u>	<u>1.12</u>	<u>1</u>	<u>1 016.046 908 8</u>	<u>1.016 046 908 8</u>
1 kilogram =	35.273 96	2.204 623	0.022 046 23	0.001 102 311	0.000 984 206 5	<u>1</u>	<u>0.001</u>
1 metric ton =	35 273.96	2204.623	22.046 23	1.102 311	0.984 206 5	<u>1 000</u>	<u>1</u>

Based on NIST Handbook 44, Appendix C - General Tables of Measurement

Weight Cleaning Procedures

The following guidance is based on information published in ASTM E617 and/or OIML R111 documentary standards. These instructions are provided for informational purposes only and can be found online in the publication Precision Calibration Weights Type I and II, Handling, Cleaning and Shipping Manual (PN 178619)

It is essential to clean weights before any measurements are made because the cleaning process may change the mass of the weight. Cleaning should not remove any significant amounts of weight material. Weights should be handled and stored in a such a way that they stay contamination-free. Before calibration, dust and any foreign particles shall be removed by brushing with a clean soft-bristle brush or gentle wiping with a non-abrasive lint-free wipe. Care must be taken to not change surface properties of the weight (i.e., by scratching the weight).

If the weight contains significant amounts of contamination that cannot be removed by brushing with a clean soft-bristle brush or gentle wiping with a non-abrasive lint-free wipe, the weight or some part of it can be washed with clean alcohol, distilled water or other solvents. Weights with internal cavities should normally not be immersed in the solvent to avoid the possibility that the fluid will penetrate the opening. If there is a need to monitor the stability of a weight in use, the mass of the weight should, if possible, be determined before cleaning.

After weights are cleaned with solvents, they shall be stabilized for the times per ASTM E617 for classes 000-7 and OIML R111 for classes E1, E2, E3 and F2-M3 shown in Table below.

Stabilization Timeline				
Weight Class	000 00 0 E1	1 E2	2 F1	3-7 F2-M3
After cleaning with alcohol	7-10 days	3-6 days	1-2 days	1 hour
After cleaning with distilled water	4-6 days	2-3 days	1 day	1 hour

Categories of Weights

Weights are divided into four categories for cleaning purposes.

- One piece weights (except lacquered, sheet metal or small wire weights).
- Screw knob weights which includes all weights with adjusting cavities (except lacquered weights).
- Lacquered weights.
- Sheet metal weights and wire weights.

NOTE: Do not touch the weight with bare hands.

One Piece Weights

Wipe one-piece weights clean with a soft, non-abrasive material, such as high-grade cheesecloth, which is free from oils or other substances that may leave a residue on the surface.

Occasionally, a weight may have foreign material adhered to it which requires the use of a solvent for removal. First, attempt to remove the foreign materials using ethyl alcohol. If this does not work, try another solvent. Once the foreign materials are removed, use ethyl alcohol to remove film or residue left by other solvents.

Screw-Knob Weights

Wipe screw-knob weights clean with a soft, non-abrasive material, such as high-grade cheesecloth, which is free from oils or other substances that may leave a residue on the surface.

Occasionally, a weight may have foreign material adhered to it which requires the use of a solvent for removal. First, attempt to remove the foreign materials using ethyl alcohol. If this does not work, try another solvent. Once the foreign materials are removed, use ethyl alcohol to remove film or residue left by other solvents.

Lacquered Weights

The cleaning of lacquered weights requires special care because their protective lacquer coating is soluble in most solvents.

Wipe the weight clean using a soft, non-abrasive material, such as high-grade cheesecloth, which is free from oils or other substances that may leave a residue on the surface. Brushing the weight with a soft brush, such as camel hair, can also be used to clean the weight.

A rubber bulb type syringe may be used to blow off lint or other small particles. Take care not to touch the weights with the nozzle or any other part of the rubber bulb.

An electrostatic charge may be placed on the surfaces of the weights during the cleaning process or while handling them. This can be especially troublesome in a very dry atmosphere. If reliable mass values are to be obtained, the charge must be bled off the weights before calibration.

Sheet Metal and Small Wire Weights

Wipe sheet metal and small wire weights clean with a soft, non-abrasive material, such as high-grade cheesecloth, which is free from oils or other substances that may leave a residue on the surface.

Occasionally, a weight may have foreign material adhered to it which requires the use of a solvent for removal. First, attempt to remove the foreign materials using ethyl alcohol. If this does not work, try another solvent. Once the foreign materials are removed, use ethyl alcohol to remove film or residue left by other solvents.

Weight Cleaning Procedures

Cleaning Interval

Weights should be maintained in a manner that the weight is kept free from dirt and contaminants which could affect the integrity of the weights.

Weights do not need to be cleaned every time they are used. The interval between cleanings may be several months if the weights are handled carefully and kept in a clean atmosphere under a dust-tight cover when not in use. Under less favorable conditions, the interval between cleanings may be only a few weeks.

Temperature Equilibrium

Allow newly cleaned weights to come to room temperature prior to calibration. This may take several hours for large weights that have been cleaned. Generally, laboratory weights will come to temperature equilibrium overnight.

Storage

Weights are not typically placed on a balance immediately after cleaning, but rather are placed in storage. Store weights under a dust-tight cover to keep them clean. Weights weighing one gram or more may be stored on a tray lined with filter paper and covered with an inverted glass dish. Smaller weights may be stored in a small glass dish covered with a watch glass. In both cases, the container should be labeled with the weight identification. Carry the tray or dish in a level position so the weights do not slide around.

Prior to using a weight on a balance, be sure to brush off any particles that may be on it. A small bulb-type rubber syringe is useful for removing lint and other small particles. Use the bulb at a short distance from the weight to blow off particles. Ensure that neither the nozzle, nor any part of the syringe, comes in contact with the weight.

Brushes

All equipment used in cleaning and handling weights should, of course, be clean. Brushes, however, require special attention because they are easily contaminated and are often the last cleaning device used before the weights are calibrated. Use only soft brushes, such as camel hair, on the weights.

Clean the brushes using soap and water, rinse in ethyl alcohol and allow to air dry. Place the brushes in a manner that they do not touch anything else while air drying. Prior to using new brushes, they must be cleaned to remove oil or other substances that could contaminate the weights. Clean used brushes as often as necessary to ensure the brushes themselves do not contaminate the weights. Store cleaned brushes in containers that will keep them clean until needed. When handling the brushes, do not touch the bristles, as oil from the skin will contaminate them. If the brushes need to be set down, place them so the bristles do not touch anything.



Environmental Impacts on Precise Measurements

To be able to conduct more precise measurements, it is necessary to minimize the factors that contribute to measurement errors. There are a great variety of such error-inducing factors, which can be linked to machine error and performance of the balance itself, as well as the properties and condition of sample being measured, and the measuring environment (e.g., vibration, temperature/humidity). These factors can readily affect the results of measurement on a balance.

This material includes some precautionary notes that the user should bear in mind to eliminate error factors and ensure accurate measurement results.

1. Measuring Room

1.1 Temperature/Humidity

- Try to maintain constant room temperature as much as possible to prevent condensation and unstable indications due to fluctuations in temperature.
- Low relative humidity tends to induce static electricity. (Relative humidity of about 60 percent is considered ideal.)

1.2 Vibration/Shaking

- The measuring room should preferably be located on the ground floor or in the basement. Higher floors are more susceptible to heavy vibration and shaking, which make such locations less suitable for measurement. A room facing a railway or road with heavy traffic should also be avoided as much as possible.

1.3 Drafts

- Avoid choosing a location subject to a direct draft of airflow from an air-conditioning unit or exposed to direct sunlight, which may cause abrupt fluctuation in temperature.
- Avoid a room subject to a heavy flow of people, since fluctuations in drafts and temperature are likely to occur in such a location.

1.4 Gravity

- The gravity acting on a sample varies depending on the latitude or height of the location where measurement is being conducted. For this reason, the same sample may show different weight indications from one place to another. Therefore, make it a rule to calibrate the balance every time it is relocated.

1.5 Electromagnetic Waves

- When the balance is located near an object that generates intense electromagnetic waves, it may be hindered from showing accurate weight due to the effects of such waves.

2. Measuring Bench

2.1 Vibration/Shaking

- If the balance is subjected to vibration during measurement, its indications will become unstable, thus preventing accurate measurement from being conducted. To avoid this situation,

select a solid measuring bench that is less susceptible to vibration. (A bench in vibration-proof structure or one made of concrete or stonework will be suitable.) Moreover, do not conduct measurement with a soft cloth or paper placed under the balance, since the balance may be rocked out of precise level positioning.

- Place the measuring bench in a location free from vibration as much as possible. It is a good idea to install the measuring bench in a corner of the measuring room, where less vibration is likely to occur than in the center of the room.

2.2 Magnetism/Static Electricity

- Avoid operating the balance on a bench that is susceptible to the effects of magnetism or static electricity.

3. Samples

3.1 Static Electricity

- Generally speaking, objects made of synthetic resin and glass have high electric insulating properties and, therefore, are apt to be electrically charged. Measuring a charged sample may cause unstable indications. With this in mind, be sure to discharge samples before measurement.

3.2 Magnetism

- A sample affected by magnetism indicates different weight values depending on where it is located on the measuring pan, along with poor reproducibility of the results.

When a magnetized sample must be measured, first demagnetize it or place an appropriate pedestal on the measuring pan to adequately separate the mechanism part of the balance from the magnetized sample to avoid the effects of magnetism.

3.3 Absorption/Evaporation of Moisture

- Measuring a sample with moisture absorbed or evaporated (volatilized) continuously increases or decreases the values indicated. In such case, measure the sample in a container with a small opening and sealed airtight with a cap.

3.4 Sample Temperature

- A difference in temperature between a sample and the interior of a windshield may cause convection to occur inside the windshield, resulting in erroneous measurement.

Therefore, measure a very hot or cold sample only after allowing time for its temperature to acclimatize to room temperature. Moreover, to prevent convection inside the windshield, allow time for the interior of the windshield to acclimatize to room temperature.

- The body heat of a person conducting measurement can also affect measurement results. Avoid holding the sample with bare hands, and use long tweezers or a similar tool instead. Also refrain from putting your hands inside the windshields while measurement is in progress.

Environmental Impacts on Precise Measurements

4. Main Unit of the Balance

4.1 Precautions on Use

- The balance is protected with a transparent dust cover. The dust cover may be statically charged immediately after removal from the packing box or under low humidity conditions. Unstable indications by the balance may be due to a statically charged dust cover. Wipe the dust cover with a damp cloth or use a commercial antistatic agent. Simply operate the balance with the dust cover removed to assist with this problem.
- To achieve more accurate weighing, wait at least 30 minutes after switching on the balance, then use the balance only after loading it several times with an object of weight equal to the weighing capacity.

4.2 Calibration

- Periodically calibrate the balance to ensure accurate measurement at all times.
- For more precise calibration, use an external calibration weight that approximates the weighing capacity. Moreover, calibrate the balance only after allowing time for proper acclimation to ambient temperature following power-up.
- Wait at least 30 minutes after switching on the balance, then perform calibration only after loading the balance several times with an object of weight equal to the weighing capacity.

Calibration is also required in the following cases:

- When operating the balance for the first time
- When the balance has not been used regularly
- When relocating the balance
- When there is wide fluctuation in temperature, humidity or atmospheric pressure

4.3 Maintenance

- When the measuring pan or pan base is contaminated with powder or liquid, erroneous weight values may result or indications may remain unstable. Therefore, be sure to frequently clean the balance. When cleaning the balance, be very careful not to allow dirt or liquid to penetrate inside the mechanism.

Conditions that influence measurement results.

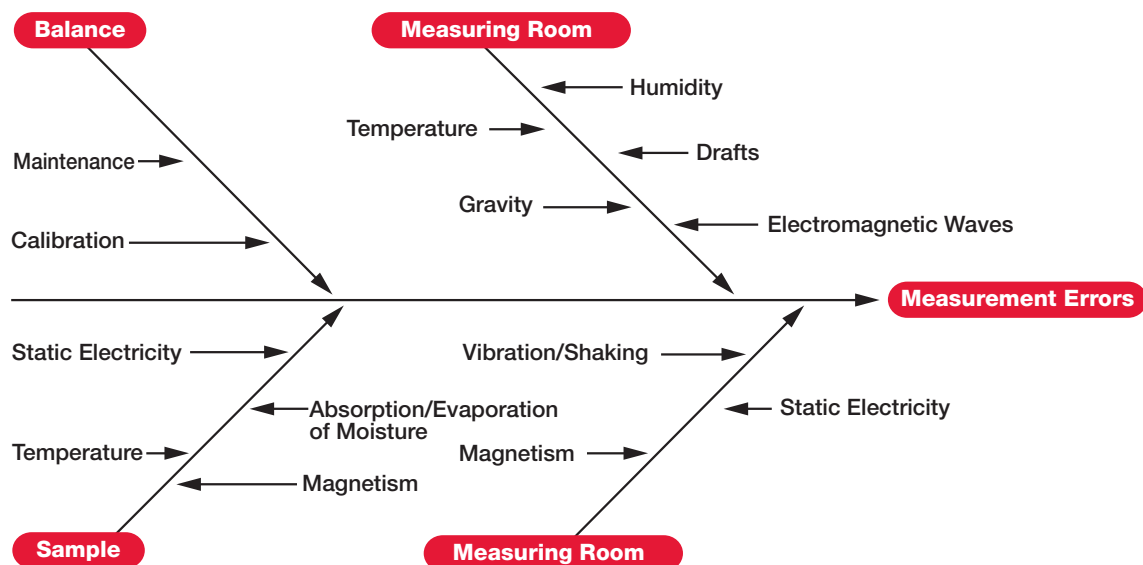

Weights, Balances and Uncertainty

Factors that can influence which balance is appropriate for your application:

1. Capability – the need for multiple balances
2. Readability
3. Capacity
4. “Accuracy” vs. “readability”
5. Repeatability and linearity
6. Units of measure
7. Platform dimensions
8. Environmental consideration
9. Communications interface
10. 21 CFR Part 11 compliance
11. Data reporting
12. Legal for Trade requirements

As with any other testing device or sensor in the laboratory, a complete understanding of the factors that can influence proper weighing/test results is very important.

For proper installation and maintenance of a balance, it is important to limit uncertainty. Uncertainty can be defined as a statistical estimated amount or percentage by which an observed or calculated value may differ from the true value.

Uncertainty of Weighing Results

For this exercise, presume the balance indication, sensitivity of the weighing device, application of the load and proper zero setting of the device are all operating without question and those elements under the original control of the device manufacturer (i.e., overall design, accuracy readability, sensitivity, drift and off-center loading characteristics) are within the device’s design specifications. What needs to be determined is the impact of other influences on the uncertainty of test results.

Examining the design of the balance’s installation is a critical step in the use of a precision weighing device and is often overlooked. The installation is the most imperative step in preparing for reliable results. If this area of use is understood and secure, reliable test results are more likely to be achieved.

Electromagnetic Force Restoration

In an electromagnetic force restoration balance, a current is regulated by a servo amplifier in a way that the electromagnetically generated force and the weight force applied to the platform by the object being weighed are in equilibrium (balanced). Maintenance of the equilibrium is controlled by a small sensor known as a position sensor. If weight is added to the weighing pan, this destabilizes the state of equilibrium and the overweight load causes the force-transmitting lever to move upward into the range of the position sensor. This in turn generates an input signal at the servo amplifier, causing a greater amount of current to flow through the coil and therefore increase the counter force until equilibrium is restored. The current simultaneously flows through a resistor where it causes a drop in voltage

proportional to the change in weight on the platform. This voltage drop is digitized in an analog/digital converter so that the result is processed in a digital signal-processing unit (microprocessor), which can then in turn be indicated on a digital display with the appropriate mass indicator.

Leveling the Balance

Most balances available today include a “bubble level” or “bull’s-eye-level” on the device. Along with this feature, two or more of the legs on the balance are adjustable, allowing for adjustment of the horizontal plane of the device to compensate for an out-of-level working surface. Use the bubble level and adjusting legs to ensure the balance is properly leveled. An out-of-level balance will add uncertainty to test results.

Room Conditions

Ideally, the laboratory should have the following characteristics at a minimum:

1. Only one door (to prevent air drafting).
2. Limited personnel access to prevent drafting and other changes to the environment in the areas of temperature, relative humidity and atmospheric pressure.
3. A limited number of windows, if any at all. If there are windows, choose a location so exposure to direct sunlight is limited.
4. The work surface that is dedicated to the balance should be located at a corner of the room, immediately opposite to the wall containing the door. Also, the door should swing inward into the laboratory with a balance table positioned so that the door can act as a shield against drafting from sources external to the laboratory.

Working Surface

Ensure the working surface is clean, firm and stable. Make sure it does not feature dual or tandem connection to the floor and a wall. If at all possible, the working surface should be used only for work involving test measurements with the balance.

Ergonomics

Ensure the balance does not need to be moved to meet the various requirements induced by testing and user parameters. Balances are not designed to be relocated between applications, technicians and laboratories. If a balance is moved after installation, the results of your installation and calibration work are no longer valid. Reinstallation should be performed before the balance is used again.

Types of Balances

Semi-micro and Micro: four or more place balance
 Analytical Balance: 0.001g (or 1 mg), normally has draft shield
 Top Loader/Precision: 1 - 0.01 g
 Compact/Portable: 1 g

Weights, Balances and Uncertainty

Air Currents

Inherent with the sensitivity of most balances is the ability to be affected by even the slightest of air movements. There are two simple ways to evaluate the impact of air currents surrounding the balance.

Option 1: A simple device known as a smoke tube will generate a harmless trail of smoke that will follow an ambient air current. Although this is a good visual indication, this method is sufficient only during the time the test is being conducted.

Option 2: Use the balance as a “breeze sensor.” To conduct this test, complete the balance installation and setup following the manufacturer’s instructions. Connect the balance to a computer (according to manufacturer’s instructions). Configure the balance to interval print every 10 seconds. Configure the computer so that the information from the balance is imported into a spreadsheet, such as Microsoft Excel. Begin the test by activating the print sequence on the balance. Interval printing will continue at 10-second intervals for a set period of time to secure an evaluation of the environment surrounding the balance. Once the test has been completed, turn off the interval testing. Chart the results of the data now resident in your spreadsheet. Evaluate the results to determine if there are factors in the environment that you wish to avoid. An optional breeze-break will modify the unwanted behavior. If you are using an analytical-style balance (those devices with an integral breeze-break), this observation should not be overlooked.

Vibration

This contaminant can result from something as subtle as a person walking by or a constant low-frequency hum of a large piece of manufacturing equipment located several work areas away from where the balance is located. Anti-vibration pads placed under the feet of the balance can be a low-cost solution.

Magnetism

Magnetic fields within close proximity to the balance may cause weight errors. Sources of magnetic fields range from small motors and computer displays. To test weights and mass standards. Magnetism in mass standards and test weights cannot be completely eliminated once the device is in the field. The proper care and handling of test weights and mass standards is equally important to minimizing uncertainties as the proper installation and use of a balance.

Powerline Noise

If possible, ensure the balance is connected to a dedicated power circuit. At a minimum, use a conditioned power strip to ensure against errors in repeatability.

RFI/EMI

Common devices used in work environments can interfere with the proper operation of a weighing system. These include two-way radios, wireless

telephones, cordless phones and wireless LAN communications. With the balance operating and presenting a stable zero reading, use a two-way radio, cell phone or any other electronic device within close and various proximity to the balance. Any sudden change in reading may indicate some level of interference and corrective action should be considered. Another option is to contract a professional experienced with detecting, measuring and compensating for RFI and EMI.

Fluctuations in Temperature

Ideally, lab temperature does not change over the course of a normal 24-hour period more than one to two degrees Celsius. Realistically, however, many factors prevent this ideal except in the most controlled environments. To compensate for this, many balances have an internal automatic temperature-sensitive calibration. It is important to purchase and use devices with this feature. When a change in temperature that could affect the outcome of a weighing is detected, the operator is notified that recalibration is required, or, on some units, the device’s own internal calibration routine automatically compensates for the temperature change.

The laboratory should be as free from windows and direct sunlight as possible. If such a consideration is impossible, keep weighing areas away from windows, direct sunlight and heat and refrigeration sources. The ideal humidity range for most balances is between 45 percent and 60 percent non-condensing relative humidity.

To maintain the balance’s optimal internal thermal equilibrium, the balance should not ever be turned off. When using a balance with an enclosed weighing chamber, always use a tweezers or other mechanical gripping device to place things in or remove things from the weighing chamber. When choosing a container to hold a weighing sample, select one with a small surface area.

NOTE: If using a device with an integral breeze-break, note the difference between the environment inside and outside the weighing chamber. If unsure about the weight vs. temperature properties of the commodities being tested, prepare two “identical” samples of the commodity. These “identical” samples should have the same weight value. Leave one sample outside the weighing chamber next to the balance. Place the other sample inside the weighing chamber, but not on the weighing platform. Add the second sample inside the chamber to equalize to the weighing chamber’s temperature. Weigh the sample inside the weighing chamber once it has equalized to the chamber temperature. Immediately weigh the sample that was outside of the weighing chamber. If there is any difference in weight, you will need to achieve temperature equilibrium between the sample and the weighing chamber before making future weighing transactions.

Sample Conditions

The weight of a sample will increase or decrease depending on its exposure to volatile substances. Similarly, the sample will behave differently dependent on the evaporation of water or the absorption of moisture by the sample itself. Always use clean and dry weighing containers to hold the sample(s) under test. Keep the weighing platform and/or weighing chamber clean and free from foreign substances that may interfere with the testing results. Use weighing containers with as narrow an opening as possible and keep these containers covered unless direct and specific work is being done with the samples.

Weights, Balances and Uncertainty

Condition of Electrostatic Discharges

ESD usually demonstrates itself in one of two ways:

1. Repeated weighments of the same sample return dissimilar results.
2. The reading on the weight display is unusually unstable even though all other environmental concerns seem to be accounted for.

The following procedures can help counteract ESD. In some instances, following more than one of these procedures may be necessary:

- a. Avoid weighing vessels made of plastic. Glass is preferable.
- b. Ground the device. This can be achieved by running a wire from the chassis of the device to a direct ground connection.
- c. Ground the technician. These solutions include ESD wrist straps, ESD-proof laboratory coats, anti-static hand soap, etc.
- d. Use anti-static brushes to discharge ESD within the weighing chamber.
- e. Discharge ESD in the balance's immediate environment.
- f. There are a number of solutions that provide a constant stream of neutralized ion air that eliminates antistatic build-up.
- g. If the above procedures fail to correct the ESD problem, consider using only metal sample containers.

Installation

Who is doing the installation? There are basically three types of “installers” for precision weighing equipment: laboratory technicians, maintenance staff or a dealer technician. If you have purchased your balance directly from one of the major catalog suppliers, your options for installation and maintenance are limited to either a laboratory technician or the in-house maintenance staff. Find the individual with the most experience and ensure they thoroughly follow the instructions that come with the device. If you have purchased your balance from a local scale or balance dealer, you have the benefit of requesting installation by a dealer technician. This is the preferable option. A scale or balance dealer's technician is a trained professional who, by definition, is sensitive to all of the factors that we have discussed in this section. Additionally, you have the benefit of being able to call them back and troubleshoot either the device or the environment if you have difficulty.

Operator Training and Certification

Who is going to use the balance? Operator training and certification on a weighing device cannot be overstated. Operator errors are not only a result of individuals being inadequately trained, they also add untold degrees of uncertainty to valuable test results. Every operator should have at least a background in weighing technology, even if it is limited only to the device in question. Additionally, they should have a thorough understanding of the test process and the necessity to correctly record data thus preventing an erroneous influence in the significant process evaluation.

In summary, careful planning and/or suitable corrective action will minimize and possibly even eliminate many sources of uncertainty within your weighing process. It is possible that you will determine the need to test the balance at its planned location, and perhaps other alternative working sites in order to arrive at the best performance parameters. This will exclude influences of the surroundings or the operating personnel. By controlling the optimum performance of the balance based on its location and proper installation, you can significantly reduce uncertainties in your weighing processes.

With all of these factors under control, you should be able to proceed now using good laboratory weighing practices to determine the standard deviation of your device, as well as the uncertainty of your process.

Weights, Balances and Uncertainty

USP Modifications in Chapter 41 and 1251

After its initial modification to Chapter 41 and 1251 in December 2013, The USP (U.S. Pharmacopeial Convention) is continually refining its requirements for balance calibrations. A balance calibration is a check to verify that the balance's weight display matches the nominal weight value. Many people interpret this to be calibration with adjustment; however, a calibration is a verification not an adjustment.

The USP requirements state that calibrations are applicable when substances must be "accurately weighed." Balance weighing should be performed using calibrated equipment that has been calibrated at capacity and tested for repeatability and accuracy. The balance should also be tested at a minimum weighing point and not used below that point.

Complete, up-to-date information can be found at www.usp.org.

The new minimum weight requirements establish guidelines for operators to use the balances within a certain range. This is calculated from the repeatability test and begins at a point where the balance's repeatability is less than or equal to 0.10%. The specification states that the minimum weighing range will be 0.41 divisions (or the larger repeatability test result).

The impact of these requirements establishes best practices for balance applications. Balances that may have been purchased for applications

based on specification sheets may not perform to those specifications in real-life applications. With these requirements, balances will be calibrated (checked) and a routine system established to make sure that the balance meets the application requirements.

REPEATABILITY of the balance is tested by weighing one test weight 10 times. The weight used is within the balance's operating range. The weight does not need to meet any calibration requirements as the weight is used to check that the readings are repeatable. The results are acceptable if "two times the standard deviation of the weighed value, divided by the desired smallest net weight (i.e. smallest net weight that the users plan to use on that balance) does not exceed 0.10%."

ACCURACY is acceptable if the balance's weighing value is within 0.10% of the test weight value. The accuracy test weight is a calibrated weight with maximum permissible error (MPE), or its uncertainty, of one-third of the applied test limit of the accuracy test.

In order to help laboratories and businesses comply with these updated guidelines, Rice Lake offers Essential Weights™. Designed with convenience in mind without sacrificing precision, Essential Weights are sets of stainless steel test weights specifically tailored to your balance.

Chapter 41	Previous	Updated
Scope	Defines the requirement for balances used to weigh analytes for quantitative measures	Same scope with new language for added clarity
Calibrated balance	Not specified	All balances must always be calibrated
Number of balance tests	1 - repeatability	2 - repeatability and accuracy
Test 1 - Repeatability		
Limit of repeatability test	≤ 0.1%	≤ 0.10%
Expansion factor	3	2
Total replicate weighing procedures	10	10
Acceptance criterion	$3*s/m \leq 0.1\%$	$2*s/m \leq 0.10\%$
Other criterion	N/A	If the repeatability obtained is smaller than 0.4 d, where d is the scale interval, replace the standard deviation with 0.41 d
Test 2 - Accuracy		
Limit of accuracy test	N/A	≤ 0.10%
Test weights	N/A	Between 5% and 100% of the balance capacity
Chapter 1251	Previous	Updated
Scope	Applies to all analytical procedures	No change
Balance Test		
Performance test	Drift check to be performed daily	Risk analysis determines the frequency of any test
Built-in weights	N/A	Checks can be partially replaced using automatic or manually triggered adjustment by means of built-in weights
Minimum weight	N/A	The minimum weight applies to the sample weight, not the tare or gross weight
Calculation of minimum weight	N/A	Derived by using a test weight up to a few percent of the balance capacity: $m=2000*s$
Repeatability test	N/A	As repeatability fluctuates, weighing should be performed at larger values than the minimum weight

Properties of Magnetism in Mass Standards

Editor's Note

Since this article was first published, the concern over magnetism in calibration weights has evolved to a new level. Unfortunately, a number of issues surrounding the measurement of magnetism in mass measurement has created frustration for mass calibration laboratories and for accreditation bodies. To proactively address this topic, NCSLI brought together interested parties to discuss issues with the intent of coming to some resolutions on how to handle the various issues. As a result of these discussions a number of resolutions were adopted.

1. Laboratories should not include an uncertainty component for magnetism measurements in mass calibrations.
2. NVLAP's position is that for Echelon I and II measurements (corresponding to OIML R 111 classes E1, E2, F1 and F2) laboratories should:
 - 1) State on their certificates whether or not they are screening for magnetism.
 - 2) State that no component is included in their uncertainty statement for magnetism effects.
 - 3) Include a discussion/written agreement as to the laboratory's practice regarding magnetism screening (or lack of screening) as a part of normal contract review with laboratory customers.

So then, why does Rice Lake screen calibration weights for magnetic influences? Our dedication to provide you with the utmost value for your dollar. Should we fail to test for magnetism, we could inadvertently provide you with erroneous calibration data. This data would not be repeatable in your facility. Therefore the assurance and traceability of your own work could be jeopardized.

Our philosophy always has been and will always be to take care of the customer first.

By testing for magnetic influences prior to executing a weight calibration, we continue to provide you with a quality of work unparalleled within the industry, keeping your needs first.

What problems can magnetic balances cause?

When working with balances, magnetic field strength can be increased in a standard that has high susceptibility, even if the standard previously had a low or insignificant magnetic field strength. The solution seems obvious: don't expose the standard to a balance with magnetic properties. This is easier said than done. A balance with magnetic properties will reproduce its measurements as long as there are no other magnetic fields intersecting the balance's own field; thus, the magnetic field of the balance goes undetected. Introducing a standard into the balance's magnetic field, even one with very low field strength, has the potential to increase the magnetism of the standard. In this manner, a standard that formerly had no problems could potentially accumulate serious problems. To avoid this situation, the magnetic field of the balance and the magnetic susceptibility of the standard must be measured.

In 1994, a magnetic round robin was performed by several metrology laboratories to test the effect magnetism has on weight measurements. This round-robin was designed to show how close the laboratories' results would be after performing a calibration on one kilogram standards with known magnetic properties.

The balances compared and the approximate standard deviation of observed differences for these tests are shown below.

Balance Comparison	Standard Deviation
400 mG magnetic vs. 800 m non-magnetic	0.09 mg
400 mG magnetic vs. a non-magnetic	0.14 mg
400 mG magnetic vs. a different non-magnetic	0.14 mg
800 mG magnetic vs. a non-magnetic	0.2 mg
800 mG magnetic vs. a different non-magnetic	0.2 mg
Non-magnetic vs. another non-magnetic	0.3 mg

These tests show that a balance responds to magnetic properties of a mass regardless of the type of force the magnetic properties are exerting. However, the magnetic fields which are present in one balance are not necessarily reproduced in a different balance. Because of this phenomenon, it is difficult to reproduce the measurements from one facility to another. If this theory is true, the link of traceability for standards with magnetic properties is obviously broken because the magnetism causes an inability to reproduce consistent measurement results.

The graph below shows the results of the magnetic round-robin, clearly showing the inconsistencies that can occur.

Results of magnetic round-robin.

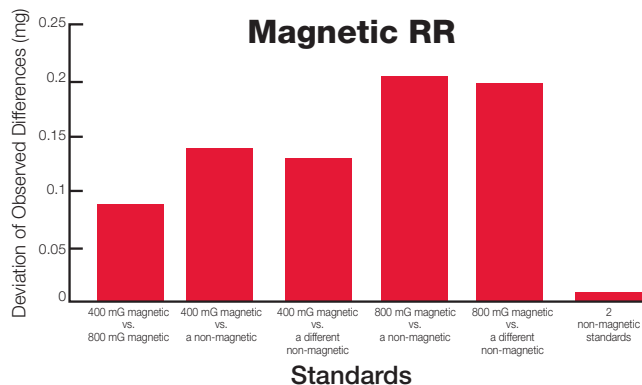

How does magnetism develop during the manufacturing of mass standards?

The existence of magnetic properties during the manufacturing of mass standards warrants careful consideration. Due to the numerous possibilities of creating magnetic properties, it is difficult to produce a mass standard from austenitic (virtually non-magnetic, highly corrosion resistant) stainless steel completely free of magnetic properties.

Properties of Magnetism in Mass Standards

On April 11, 1946, F. A. Gould from the National Physical Laboratory wrote in the Journal of Scientific Instrumentation: "Analytical weights of stainless steel have been on the market for several years. The kind of stainless steel used for their construction is one which purports to be reasonably non-magnetic, being of the austenitic variety; and up to the present time the 18/8 type of austenitic steel, that containing 18% chromium and 8% nickel, has been employed for this purpose in this country. The quality of the finished weights, however, has not been very satisfactory in regard to their magnetic properties, and some have been found permanently magnetized to an appreciable extent."

Mass standards are manufactured through a variety of methods, including turning, milling and casting. Before beginning the manufacturing process, it is imperative to choose the proper materials. When choosing materials, the most important factors to consider are machinability, corrosion resistance, porosity and magnetic properties. The magnetic properties generally develop when austenitic stainless steel is cold-worked. Although cold-working adds tensile strength, mass standards do not normally require added tensile strength.

Which Materials Are Best for Manufacturing Mass Standards?

Three hundred (300) series stainless steels are often used to manufacture mass standards because their chemical composition is highly resistant to corrosion. Certain materials found within 300 series stainless steels such as iron, cobalt and nickel may possess ferromagnetism. Ferromagnetism occurs when a small external magnetic field produces an alignment of atomic magnetic dipole moments, which in some cases can persist even when there is no external magnetic field. This occurs because the magnetism of these substances exerts such a strong force over a small region of space that the magnetism is found on surrounding materials, even when no external magnetic field exists. In addition, cold-working these materials often changes the austenite to ferrite in the material.

Several tests were conducted by the National Physical Laboratory, United Kingdom, to evaluate the materials used for manufacturing weights. In one of these tests, finished weights of 18/8 steel obtained from several sources

of supply were tested. About half of the weights in these tests exhibited a magnetic permeability of 1.02 or less, but the remainder of the weights showed higher magnetism. Several weights showed a permeability value of 1.1, and one showed a high permeability value of 2.6. Some of this material was found to have become permanently magnetized to an elevated extent.

Because of the variety of austenitic steel which is available, additional tests were performed to help in the selection of a material with non-magnetic properties. These tests found that 18/8 materials were not satisfactory with respect to magnetic properties. The chart below depicts the magnetic permeability of different stainless steel compositions.

When comparing the processes required to manufacture mass standards or to manufacture the stainless steel to produce the standards, this chart provides a general idea of the magnetism problems which may occur. Most purchasing personnel are not aware of the problems of magnetism, so when the purchase of materials takes place, materials are requested by their manufacturing names, such as 310, 304 and 316.

These names are like recipes in that they give a process for heat treating the material and a range for the chemical composition. Most of these materials have a heat treating process that returns the materials to an austenite state after any cold working process. However, sometimes this heat treating process may leave the materials bent or twisted. In order to supply vendors with the proper materials, a secondary process to straighten the materials must be performed. This process is still within the requirements for the materials, but the cold-working during the straightening process leaves the materials with magnetic properties. This is most common in smaller size diameters.

Aside from the risk of the materials having magnetic properties from the start, weight manufacturers add to the possibility of elevating magnetism during the series of cold-working processes necessary to produce the mass standard. Manufacturers must use either a saw or lathe operation to start the process. The removal of any metal in this fashion is considered a cold-working process. Polishing and stamping are also cold-working processes. These operations can and do produce magnetic properties in the standards.

Chemical Composition									Magnetic Permeability	Magnetic Permeability After Cold Rolled to give a 33% Reduction in Area
C	Si	Mn	S	P	Cr	Ni	W	Cu		
0.03	0.57	0.55			17.45	11.9			1.003	1.10
0.14	0.6	0.58			19.8	12.96			1.003	1.005
0.07	0.24	0.44			10.33	20.7	1.73	2.14	1.015	1.04
0.09	0.23	0.44			10.3	20.26	1.79	2.20	1.013	1.021
0.13	0.19	0.36			9.72	20.28	1.55	2.39	1.021	1.045
0.10	0.26	0.42			10.85	20.71	1.83	2.13	1.016	1.043
0.10	0.26	0.48			10.42	20.77	1.57	2.32	1.012	1.021
0.09	0.22	0.39			10.41	20.17	1.67	2.19	1.014	1.024
0.10	1.71	0.78	0.017	0.011	24.27	20.40			1.002	1.003

Properties of Magnetism in Mass Standards

What Are the Requirements for Magnetic Properties in Mass Standards?

The United States uses the American Society for Testing Materials (ASTM) specification E 617-18 for specifying the requirements of magnetic properties in laboratory weights and precision mass standards. This specification was replaced by the National Bureau of Standards (NBS) Circular 547, Section 1 in 1978 and recognizes the international recommendations of the Organization Internationale De Metrologie Legale (OIML) R111, edition 2004.

According to the ASTM E 617-18 specification, magnetic properties must be measured in magnetic field gradients because unshielded devices in the vicinity of the measurement can affect the accuracy of measurements. Higher grades of weights have lower magnetic susceptibility. Grades S, S', O and P should not be more magnetic than 300 stainless steel.

The OIML international recommendations include requirements for magnitude of magnetic susceptibility. They state that the metal or alloy used for weights of Classes E1 and E2 shall be practically non-magnetic (magnetic susceptibility K not to exceed $K=0.01$ for Class E1, $K=0.03$ for Class E2, and $K=0.05$ for Classes F1 and F2).

How Can Magnetism Be Avoided?

Although magnetism cannot be completely avoided, steps can be taken to control the effects of magnetism on the accuracy of weight measurements. The area where the weighing occurs should be tested with a gaussmeter for magnetism created by electrical wiring, motors and any other components in the area. If the testing shows magnetism is present in the area, another location should be chosen for the measuring process.

A gaussmeter should also be used to test the balances for magnetism. Even if the standards have very low magnetic strength, the internal components of a balance may cause varying results. For example, if the components of the balance have a magnetic charge, the standard introduced to the balance will change the force exerted on the load device, causing inconsistent results from one device to another. Balances should be tested whenever there is any suspicion of magnetic problems, such as erratic weight measurements. The gaussmeter shows which part or parts of the balance are magnetized and need to be replaced.

The elimination of magnetism in mass standards is not likely to happen. However, if the proper steps are taken, the magnetism in mass standards can be significantly reduced. Starting with the manufacturing process, the proper methods and materials must be chosen. Then, the mass standards should be tested for magnetic properties. Finally, remember that the magnetism inherent in the environment, balances and standards will cause some degree of inconsistency in mass measurements, no matter what preventive steps are taken.

How Are the Magnetic Properties of Mass Standards Measured?

Although specific requirements for magnetic susceptibility are a good start, magnetic field strength is also a very important factor that needs to be measured. Susceptibility adds to the potential of an item becoming magnetized or further charged. Measuring the magnetic field strength of the

standard shows whether the magnetism is significant enough to cause mass measurement errors.

Richard Davis of Bureau International des Poids et Mesures (BIPM) wrote an article entitled, "New Method to Measure Magnetic Susceptibility," in which he describes a process he developed for measuring magnetic susceptibility. The following pieces of equipment are used to perform the measurements:

Balance

The balance must have a 5-gram capacity (to leave enough range in the balance to place the column and magnet on it and perform the measurement) and a resolution of greater than or equal to one microgram. The weighing chamber is a glass tube with a removable glass top. The original top is replaced with one made of an aluminum alloy because aluminum contains very little magnetism.

Magnets

Two high quality cylindrical magnets (constructed of neodymium-iron-boron) are used in this measuring process. Each magnet has a height of 2.5 millimeters and a diameter of 5 millimeters. The axis of magnetization coincides with the geometric axis of the cylinder. Two such magnets are combined to produce a cylinder of height equal to diameter.

Pedestal

The magnet sits on a tubular pedestal that is centered on the balance pan. Holes drilled through the wall of the tube ensure that the total mass of the magnet and pedestal is well within the capacity of the balance.

Bridge

Samples are centered on an aluminum alloy bridge that straddles the weighing chamber of the balance. The bridge must be designed so the span can be made level with respect to the balance pan. The span should be as thin as possible, with adequate mechanical rigidity. If the span sags in the middle, samples with a large diameter will be farther from the magnet than samples with a small diameter.

Gauge Blocks

It is convenient to place the bridge on non-magnetic gauge blocks so it may be raised or lowered in precise 5-millimeter increments.

Magnetic Susceptibility Standard

The magnetic susceptibility standard can be the identical shape of the item being tested or a cylindrical shape that has been calibrated by known standards.

Once all of the equipment has been assembled, the distance from the center of the magnets to the top of the bridge must be calculated to determine the magnetic force. This can be done by using the known magnetic standard. After the distance is calculated, the samples that need to be tested may be introduced. The samples are calculated based on the distance from the magnets and the response of the balance. If the samples have different geometrical values, additional calculations must be performed to solve for the volume of magnetic susceptibility.

Balance Verification Using Calibrated Weights

The following is an example of how to use calibration weights with the appropriate pedigree to calibrate and verify an electronic weighing device such as an electromagnetic force restoration balance. Manufacturer's operating and maintenance instructions should always be referenced prior to performing a test or making adjustments. Pay exceptional attention to the manufacturer's discussion on the environment suitable for the device. At the end of these procedures, refer to "Environmental Impacts on Precise Measurements" on page 256 of this catalog for information regarding weighing influence factors. Failure to consider these specifications and conditions will invalidate this procedure. Please contact us if you cannot locate the operating instructions for your device. We may be able to provide a duplicate.

Equipment Required:

- Balance
 - Accessory printer (to document calibration changes and results)
 - Cotton gloves
 - Tweezers
 - Tongs (as appropriate to handle the calibration weights)
 - Weight calibration certificate or traceable certificate
1. Using the manufacturer's operating instructions, set up the balance in the environment in which it is intended for use. Allow the balance to "soak" in the environment for a minimum of 24 hours prior to any testing. This is a critical step. Many of the mechanical structures in a balance are affected by the changes in environment. To ensure a proper test with definable results, the device must be allowed to equalize within its environment.
 2. If the balance is equipped with an internal calibration feature, activate that feature and allow the printer, if so equipped, to document the results.
 3. If the balance is not equipped with an internal calibration feature, use an external electronic balance calibration weight and, following the manufacturer's recommendations, calibrate the balance. Many electronic balances deployed in the field allow you to select the size of calibration weight you wish to use. To minimize the impact of hysteresis on linearity, it is strongly recommended that you use a weight that represents 100% of the rated capacity of the device.
 4. Weight selection criteria. Selecting the appropriate size and class of an electronic balance calibration weight is not a difficult process.

Option 1: Refer to the instructions provided by the manufacturer of the balance or other weighing device. Generally, the size (capacity) and class of the recommended calibration weight will be included for your reference.

Option 2: Determine the nominal mass value needed based on the balance's capacity and resolution.

- a. Record the capacity of the balance
- b. Record the minimum increment (readability) of the balance

- c. Divide the result from item b by a factor of four. This number results in the appropriate tolerance for the calibration weight required. For example, if the balance in question has a capacity of 120 grams and a displayed resolution of one milligram (0.001 gram), the result of the calculation would be 0.25 milligram (0.00025 gram).
- d. Refer to the ASTM Weight Tolerance Table on page 246.
- e. In the column titled "Nominal Size" find the weight value closest to the capacity of the balance. If the exact number is not available, select the next smallest value. For example, a balance has a capacity of 120 grams. The closest value but smaller than the rated capacity of the balance is 100 g.
- f. Read across the table to the right to locate the tolerance that is closest to, but smaller than the value of 0.25 milligrams calculated in item c. The first value that meets this criteria is 0.13 milligrams, Class 0.
- g. To assure the most error-free results, an ASTM Class 0 calibration weight should be used for this calibration exercise. However, because the value in the next column is 0.025 milligrams exactly, an ASTM Class 1 device could be selected with satisfactory results.
- h. Now we know that every calibration weight we purchase for this device must be a minimum of ASTM Class 1.

Option 3: Manually calculate the calibration weight based on the tolerance of the procedure or methodology.

- a. Given: your balance has a capacity of 120 grams.
- b. Given: your balance has a readability of 0.0001 grams (0.1 milligrams).
- c. Given: you wish to check your balance at weighing capacities of 5 grams, 10 grams and 15 grams.
- d. To get the proper results, weights with the following capacities are required: 1 each 5 grams and 10 grams

You will be able to use the 5-gram calibration weight alone to test the device at 5 grams; the 10-gram weight alone to test the device at 10 grams; and the 5-gram and 10-gram calibration weights together to test the device at 15 grams.

- e. Given: the tolerance you are looking for in your procedure is 0.5 milligrams.
- f. Divide your tolerance of 0.5 milligrams by a factor of 4. This results in a tolerance of 0.125 milligrams.
- g. Refer to the ASTM Weight Tolerance table on page 246.
- h. Because more than one weight is being used to accomplish this test, cumulative tolerance will need to be applied considering the tolerances of both a 5-gram and 10-gram test weight together to ensure they do not exceed 0.125 milligrams.
- i. Find the first 10-gram weight value in the column titled "Nominal Size." Read across the chart to find the value that is closest to but smaller than the calculated tolerance of 0.25 mg from step 3c above. This would be the value of 0.074 under ASTM Class 2. ASTM Class 3 cannot be used since that value 0.25 milligram is larger than the calculated tolerance of 0.125 milligram.

Balance Verification Using Calibrated Weights

- j. Follow the ASTM Class 2 column until you are across from the 5 g test weight, which is the next test weight being used. As listed on the chart, the tolerance for a 5 gram ASTM Class 2 test weight is 0.054 milligrams.
 - k. Add this to the tolerance of the 10 grams ASTM Class 2 test weight from step 4. The result is 0.74 milligram + 0.054 milligram = 0.128 milligrams. This value is larger than the stated tolerance of 0.125 milligrams. Because of this, tolerances for ASTM Class 1 need to be used to improve performance.
 - l. The tolerance for an ASTM Class 1 10 gram test weight is 0.050 milligrams. The tolerance for an ASTM Class 1 5-grams test weight is 0.034 milligrams. When combined, the total accumulated tolerance of 0.084 milligram of is well within the stated tolerance of 0.125 milligrams. Therefore, for this procedure, ASTM Class 1 test weights should be used.
5. When external (preferred) or internal calibration has been successfully accomplished, select a verification weight that is representative of a typical sample used on a daily basis. If the weighing device is used for samples of exceptionally different values, consider the number of transactions with each typical sample. Develop a representative sample size for this test. The calibration weights you use for this test should not only be representative of the sample size, but also have the appropriate laboratory documentation and traceability to ensure test validity.
 6. Tare or zero the balance and verify the display reads a stable zero value.
 7. With the device reading zero, apply the sample calibration weight to the balance.
 8. Wait until the balance indicates that it is no longer “in motion.”
 9. Write down the reading on the display.
 10. Remove the calibration weight from the balance.
 11. Wait until the balance is no longer “in motion” and the display has returned to a stable zero value.
 12. Repeat steps 5 through 11, 7 to 10 times.
 13. Using the results from step 11, calculate a standard deviation.
 14. Multiply the answer in step 13 by three. This is the random error that is expected for the balance with a 99% confidence level. This number now becomes the upper and lower limits for the performance verification. In other words, the balance is performing satisfactorily when the results of a balance reading compared to the practical test weight (PTW) are no more than $PTW + STDV$ and no less than $PTW - STDV$.
 15. It is important to now verify the results of the standard deviation against the repeatability specification for the weighing device under test. If the standard deviation value is greater than the repeatability factor of the balance under test, consider the following: Recheck the installation parameter of the balance. Be acutely aware of

environmental influences on the balance under test as these can have a significant impact on the device’s performance. If you are confident that all preventative measures have been taken to ensure optimal balance performance, contact the manufacturer of the device for additional recommendations.

16. Determine the correction value from the laboratory documentation that accompanies the calibration weight used to calibrate the balance at 100% from step 3. The correction value is the error that was introduced into the balance mechanism and algorithms when the balance was calibrated in step 3. The calibration function in most electronic balances of recent manufacture compensates and sets the linearity of the device from the point in the weighing range representing the calibration load down through and including zero. It is critical that the calibration be performed as close as possible to 100% of the balance’s rated capacity. Perform balance calibration with an external calibration test weight since the linear error cannot be deduced by using an internal calibration weight. If the balance was calibrated at 100% of its rated load, 100% of the error in the calibration weight was also introduced at that point. This error is reduced to half its original value at the 50% load point. It is further reduced to 75% at the 25% load point. It is possible to make an estimation of the linear error of the calibration by the equation in figure 1 below.

LE = Linear Error

ECW = Rated Error of the Calibration Weight

L = Load

CL = Calibration Load

$$LE = \frac{(-1) \times (ECW \times L)}{CL}$$

Figure 1

17. A study of the points presented so far explains the fallacy of attempting to calibrate a balance at less than 100% of its rated capacity. Failure to do so can make the device’s performance completely theoretical and destroy the intent of uncertainty budgets.
18. It is now possible to determine the anticipated result for the verification process.
19. Using the laboratory documentation for the calibration weight that represents the typical sample weight, determine the error or correction of the weight. Also, check the uncertainty of the weight that you will use for this process. The uncertainty must be no greater than 25% of the random error of the balance being examined from step 15. If the uncertainty of the weight is greater than 25% of the random error of the balance, select a calibration weight of equivalent value but with a higher accuracy class. In the event that the correction on your laboratory documentation is a negative number, the weight in question

Balance Verification Using Calibrated Weights

is below nominal value by that amount. A positive value means the weight is heavier than nominal by that amount.

$$\sqrt{\frac{n\sum x^2 - (\sum x)^2}{n(n-1)}}$$

Figure 2

20. Calculate the expected value for performance verification using the following formula where:

- EV = Expected Value
- AMV = Actual Mass Value
- LE = Linear Error (from step 14)

$$AMV = (NV + AM)$$

Where AMV = Actual Mass Value; NV = Nominal Value and AM = Apparent Mass vs. 8.0 correction in the following formula:

$$EV = (AMV + LE)$$

21. Verification: Zero the balance and place the verification weight on the balance. If the actual reading is within the random error range established in the calculation of the anticipated value, the verification passes.

Example:

- Balance specification – 100 g x 0.1 mg
- Calibration load – 100 g (100% of rated capacity)
- Calibration weight specifications
 - 100 g Class 1 electronic balance calibration weight with a correction of + 0.10 mg
 - 10 g Class 1 electronic balance calibration weight with a correction of + 0.010 mg
- Typical sample value – 10 g

Following the instructions above (step 14), 20 measurements are taken and the standard deviation is found to be 0.3 mg. Applying a factor of three (3 x 0.3 milligram), the value calculates to 0.9 milligram.

To calculate the Linear error =

$$LE = \frac{(-1) \times (ECW \times L)}{CL} \quad \text{or} \quad 0.01 \text{ mg} = \frac{(-1) \times (1 \text{ mg} \times 10 \text{ g})}{100 \text{ g}}$$

Expected value =

$$EV = (AMV + LE) \quad \text{or} \quad 9.99999 = 10 + (-0.01 \text{ mg})$$

Verification range = 9.99999 g +/- (-0.9 mg)

The actual verification is performed and the reading on the balance results in a value of 10.0003 grams. Since this value is within the control limit, the results of the test is a “pass,” as relative to a “pass/fail” rating system.

Refer to the chart below.

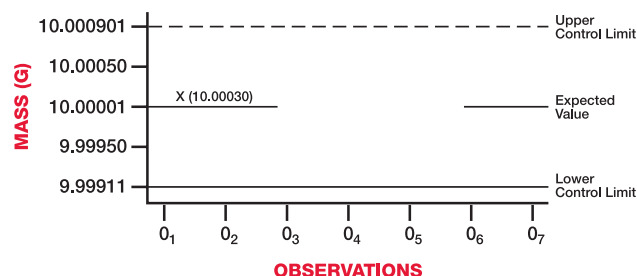

22. In the chart above, the methodology explained in this section has been followed. A weight of 10 grams is applied to the balance. The reading on the balance is 10.00010. This value has been plotted on the chart as X. It falls within the upper and lower limits and therefore, this verification observation passes.

Further suggestions

- Perform verifications at different times of the day. If you notice the results are significantly different at these different times, it may suggest that the environmental conditions within the work space are changing and may have unforeseen impact on the work being conducted.
- Constantly monitor the condition and weight value of your test weights. Under the auspices of NIST H-150, laboratories providing recalibration services are prohibited from recommending or establishing scheduled recall dates without your explicit instructions. To learn more about how to determine when, and if, a weight is due for recalibration, please contact us. We will be happy to discuss the process with you.
- Keep a constant running record of your test results and chart these results using a program such as Microsoft® Excel™. This record can help you understand the data being recorded as well as help you gain additional insight into your laboratory conditions.
- From time to time, recalculate the random error to see if your balance is performing consistently.
- Have your balance serviced according to the manufacturer’s instructions or recommendations by your dealer to ensure it maintains optimum operational parameters.

Glossary of Terms

Standard Specification for Laboratory Weights and Precision Mass Standards

Reprinted from the Annual Book of ASTM Standards. © ASTM

Accuracy Class of Weights

A class of weights that meets certain metrological requirements intended to keep the errors within specified limits (definition from OIML R 111) (2004). Weight designated with “S” prime are higher class weights.

Adjustment

The process of changing the mass either by polishing or adding and subtracting material, to bring the mass within the tolerance of a specified class.

As Found

The value of the mass recorded by Rice Lake Weighing Systems after cleaning and before any adjustment based on a density of 8.0 g/cm^3 at 20°C .

As Left

The value of the mass after any necessary adjustments are made based on a density of 8.0 g/cm^3 at 20°C .

Buoyancy Correction

The calculation needed to compensate for the varying air density in order to ascertain the true mass value.

Calibration

The acts of determining the mass difference between a standard of known mass value and an “unknown” test weight or set of weights, establishing the mass value and conventional mass value of the “unknown,” and of determining a quantitative estimate of the uncertainty to be assigned to the stated mass or conventional mass value of the “unknown,” or both. Set of operations that establish, under specified conditions, the relationship between values of quantities indicated by a measuring instrument or measuring system, or values represented by a material measure or a reference material, and the corresponding values realized by standards (definition from International Vocabulary of Basic and General Terms in Metrology).

Certificate of Tolerance Test

Document certifying subject weights are within specified tolerances. Referred to as an Rice Lake Statement of Accuracy or Rice Lake Traceable Mass Value Certificate.

Certificate of Calibration

Document presenting calibration results and other information relevant to a calibration (definition from NCSL Z-540-1-1994). Referred to as a Rice Lake Calibration Certificate or Rice Lake Traceable Certificate.

Conventional Mass

Conventional value of the result of weighing in air, in accordance to International Recommendation OIML D28 (2004). For a weight taken at 20°C , the conventional mass is the mass of a reference weight of a density of 8000 kg/m^3 which it balances in air of density of 1.2 kg/m^3 (definition from OIML D28) (2004).

Correction

Mass values are traditionally expressed by two numbers, one being the nominal mass of the weight, and the second being a correction. The mass of the weight is the assigned nominal value plus the assigned correction. Positive corrections indicate that the weight embodies more mass than is indicated by the assigned nominal value.

Density

The unit of mass divided by its volume. For a precision calibration, density testing is required to calculate buoyancy correction.

Kilogram

The kilogram, symbol kg, is the SI unit of mass. It is defined by taking the fixed numerical value of the Planck constant h to be $6.626\ 070\ 15 \times 10^{-34}$ when expressed in the unit J s, which is equal to $\text{kg m}^2 \text{ s}^{-1}$, where the metre and the second are defined in terms of c and $\Delta \nu_{\text{Cs}}$.

Metrological Traceability

Property of a measurement result whereby the result can be related to a reference through a documented unbroken chain of calibrations, each contributing to the measurement uncertainty.

Metrological Traceability Chain

Traceability chain sequence of measurement standards and calibrations that is used to relate a measurement result to a reference.

Metrological Traceability to a Measurement Unit

Unit metrological traceability where the reference is the definition of a measurement unit through its practical realization.

Set of Weights

A series of weights, usually presented in a case so arranged to make possible any weighing of all loads between the mass of the weight with the smallest nominal value and the sum of the masses of all weights of the series with a progression in which the mass of the smallest nominal value weight constitutes the smallest step of the series (definition from OIML R 111) (2004).

Glossary of Terms

Tolerance

(adjustment tolerance or maximum permissible errors)

The maximum amount by which the conventional mass of the weight is allowed to deviate from the assigned nominal value. Tolerance test verification that the conventional mass of the weights and their corresponding uncertainties as tested are correct within the maximum permissible errors of the respective weight class.

Traceability

Property of the result of a measurement or the value of a standard whereby it can be related to stated references, usually national or international standards, through an unbroken chain of comparisons all having stated uncertainties (definition from International Vocabulary of Basic and General Terms in Metrology).

Uncertainty

Parameter associated with the result of a measurement that characterizing the dispersion of the values that could reasonably be attributed to the measured (definition from NCSL Z-540-1-1994). The range of values within which the true value is estimated to lie. U.S. National prototype standard Platinum iridium kilogram identified as K20, maintained at the National Institute of Standards and Technology, with value assigned relative to the SI (International System of Units) provides the United States access to the mass unit. Weight (mass standard): A material measure of mass, regulated in regard to its physical and metrological characteristics: shape, dimension, material, surface quality, nominal value and maximum permissible error (definition from OIML R 111) (2004).

A New Era of Measurement with the Redefined Kilogram

In November 2018, the State Parties to the Metre Convention, or simply “Member States,” voted to change the International System of Units (SI). The change ruled that the system would no longer rely on physical objects and instead be determined by constants of physical science, such as the speed of light.

Currently, there is just one “true” kilogram used for every measure of mass on Earth. The International Prototype Kilogram (IPK), a cylinder of platinum-iridium, is locked securely in a vault within the International Bureau of Weights and Measures in France. Used to calibrate mass standards only once every 40 years, the IPK is treated with extreme care.

Yet even the “true” kilogram can undergo a change in mass. Because the IPK is a physical object, it is prone to wear, meaning it can lose—or gain—mass at any time. Yet since the IPK serves as the only true kilogram, there can be zero scientific uncertainty when the measurement is recorded.

Constants of nature, however, are allowed to have uncertainty in their value to compensate for errors that can occur in an experimental measurement. Following the vote by the Member States, scientists will use fixed values for constants such as Planck and Boltzmann to define the seven SI base units. The new SI redefines the kilogram by using an exact value for the Planck constant and the definition of the meter and second (already based on constants).

Although marketplace consumers are unlikely to notice any immediate effects of the change, manufacturers of scientific instruments may need to update their products in the near future.

The redefinition of the kilogram makes it possible to perform more precise, accurate measurement science without requiring calibration with the IPK. The kilogram’s new definition will promote more accurate measurements of milligram and microgram masses. Measurement scalability will improve, as measuring with physical objects can decrease accuracy at smaller or larger sizes than the standard.

Rice Lake’s metrology labs are prepared to continue to serve our customers with NIST traceability and precise calibration services. Learn more about our metrology labs at www.ricelake.com/metrology-services



Up until the SI redefinition in 2019, the National Institute of Standards and Technology (NIST) housed and maintained America’s official mass standards. Pictured above, the K20 kilogram mass standard served as the primary prototype national standard.

Historical Class F Calibration Weights No Longer Sold for Legal Metrology Uses Starting January 1, 2020

Beginning January 1, 2020, Class F calibration weights will no longer be sold for legal metrology use. According to the newly updated NIST Handbook 105-1 (2019), new weights for use as field standards placed into service for weights and measures use after this date must comply with all of the requirements of NIST Handbook 105-1 (2019).

However, existing NIST Class F calibration weights in the field will be considered grandfathered in and may continue to be used for legal metrology use as long as they meet NIST Handbook 105-1 (1990) requirements. Although the new revision does supersede the 1990 version, it makes clear that existing Class F weights may continue to be used.

This change is taking place to accommodate for the increasing accuracy of weighing devices used for legal metrology. Class F weights are no longer sufficient for the calibration, inspection or sealing of weighing devices used for the jewelry, marijuana and pharmaceutical industries.

Although existing NIST Class F calibration weights may be reclassified to one of the new specifications if all specifications and tolerances fully comply with the alternative standard, the NIST Office of Weights and Measures strongly recommends that you do not reclassify existing Class F weights due to the difficulty of performing compliance evaluation.

At Rice Lake, our metrology labs are here to help guide customers to select the best calibration weight for each application. We have two metrology laboratories that meet the new calibration requirements of NIST Handbook 105-1 (2019) to ensure a seamless transition for your calibration needs.

For more information about Rice Lake's metrology services, visit www.ricelake.com/calibration



Trademarks

The following product names, logos, brands and other trademarks featured or referred to within this publication are the property of their respective trademark holders.

Access™	ESC/POS®	Midrics®	Ranger™
Adventure Pro®	Excel™	MIFARE®	Rapid Exchange®
Allen-Bradley®	Explorer®	Minebea Intec	Rockwell Automation®
Amphenol®	Fairbanks™	Mobile 5.0™	Roman and Swiss™
AstraLabel™	Flintec™	Motiontrap™	S4M™
AstraLink™	Genius®	Motorola ColdFire®	Sartorius®
AutoCal™	Hewlett-Packard™	MS-DOS™	Scout Pro®
Beldfoil®	Howe™	NatraSorb®	SI®
Bitstream®	IBM®	Novell®	STAR®
Bluetooth®	InCal™	OHAUS®	SUREFOOT™
Cardinal®	Intel®	OKI®	Symbol®
Cent-O-Gram®	Interchange®	Pax®	The Crosby Group LLC
Centronics®	Intercomp CS™	pcANYWHERE®	TekLynx®
Citizen®	Intercomp PT300DW™	Peachtree®	Toledo®
ConnexLink™	Intercomp PT300™	Pelican™	Torque™
ControlNet®	IONMASTER™	Pick N Pluck™	TRANSCORE®
Conxall®	iPAQ™	Pioneer™	Trooper®
CRS™	ISOBAR®	PowerCell®	Turck®
Cubis®	ISOBLOK®	Powerware®	Valor®
Datalogic QuickScan®	JavaPOS™	PreVent™	Voyager®
Datamax-O'Neil®	LabelView™	Prodigy Max™	Vulcan®
DeviceNet™	LifeGuard™	Prodigy™	WinCT®
Dial-O-Gram®	Linux®	Profibus®	Windows®
DIGI®	LoopTracker™	ProPrinter®	WinWedge®
Discovery™	Lotus™	Quencharc®	Xscale®
Dymo®	Maxi-Scoop™	Quickbooks®	XTend-PKG™
EPL®	MaxWax™	QuickScan®	Zebra®
EPL2®	Microline®	QuikSharp™	ZigBee™
EPSON®	Microsoft®	R Stahl®	ZPL®

Terms and Conditions

The terms “buyer,” “authorized reseller,” and “customer” as used herein, shall mean the party placing the purchase order with Rice Lake Weighing Systems. No contractual relationship between Rice Lake Weighing Systems and said party shall arise until such time as a purchase order has been accepted by Rice Lake Weighing Systems and such acceptance has been indicated on a written acknowledgment. Tenders which do not stipulate an acceptance period shall not be binding. Orders shall be subject to Rice Lake Weighing Systems’ standard terms and conditions as printed below, subject to correction for clerical errors.

These sales terms and conditions shall be binding if declared applicable in the tender or in the order acknowledgement. Any conditions stipulated by the buyer which are in contradiction to these sales terms and conditions shall only be valid if expressly acknowledged by Rice Lake Weighing Systems in writing.

1. Prices

(a) Rice Lake Weighing Systems (Rice Lake) prices are net 30 days Ex Works Rice Lake plant. Orders are subject to approval of our credit department with rights reserved to change or withdraw credit terms without notice and to terminate any orders when invoices for work done thereon have gone unpaid for 60 days.

(b) Prices do not include taxes of any kind by federal, state, municipality or other governmental authority, which Rice Lake may be required to collect or pay with respect to the sale or shipment of goods sold hereunder. Regardless of when any such taxes are determined or become payable, all taxes would be the responsibility of the customer and would be in addition to the prices quoted hereon.

(c) This quotation is made upon the basis of the cost of materials and labor as of the date of this quotation. A change in such costs shall give Rice Lake the right to alter prices to reflect such changes in cost.

(d) Requests for additional documentation, drawings, audits of factories or inspection of equipment in-process, additional testing, additional inspections and record retention will be quoted as a separate item even if we have already issued quotations for products and services.

2. Shipment, Title, Risk of Loss

(a) All shipments are Ex Works point of shipment. Title and risk of loss or damage passes to the customer upon presentation of the goods to the customer’s carrier at Rice Lake’s facility, except that title and risk of loss or damage as to customer’s partially manufactured parts and raw materials delivered to Rice Lake, and as to jigs, fixtures and tools specially ordered for the customer shall at all times remain with the customer.

(b) Rice Lake does not carry fire insurance upon jigs, fixtures and tooling built by Rice Lake for customers or supplied to Rice Lake by customers, nor does Rice Lake carry insurance upon raw materials supplied to Rice Lake by customers. Customers assume all risk of loss, damage or destruction of jigs, fixtures, tooling or raw materials belonging to the customer in Rice Lake custody caused by fire, water, gas, natural disasters, strikes, insurrection, riots or by acts of the civil or military authorities and whether or not such loss, damage or destruction was the result of our negligence or misconduct or that of our agents or employees. The customer agrees to indemnify and hold Rice Lake harmless from all direct and consequential costs and damages resulting from such loss.

(c) Except as hereinabove stated, we agree to maintain all jigs, fixtures and tooling built by Rice Lake in working condition for their normal life only, except that our liability in this respect shall not extend more than one year after the completion of the most recent production order.

3. Quantity, Materials and Tolerances

(a) Unless dimensions are limited by a specific tolerance, it is understood that the production variations as published by Rice Lake will be acceptable.

(b) Rice Lake will not be responsible for color, thickness variations or flaws in sheets or parts from which fabrications are made, nor for other material variations beyond our control.

(c) Rice Lake assumes no responsibility for loss or damage occurring by reason of delay or inability to deliver caused by fires, strikes, accidents, embargoes, car shortages, delays of carriers, insurrection, riots, acts of the civil or military authorities, nor will we assume responsibility for any reason whatever for damages of any kind on account of failure to deliver at the time specified. The customer shall indemnify and hold Rice Lake harmless from all direct and consequential costs and damages resulting from such loss or delay.

(d) Unless otherwise specified, delivery of 10 percent more or less of completed parts than the quantity specified shall constitute fulfillment of this order and any excess not exceeding 10 percent shall be accepted and paid for by the customer.

(e) In the event any raw material specified for incorporation into the product covered by this proposal shall become unavailable, Rice Lake shall notify the customer and the customer may direct Rice Lake to substitute available material for that originally specified; it being understood and agreed that the customer shall assume any and all consequences resulting from such substitution.

4. Patents

If this quotation covers parts made specifically for the customer, the customer agrees to indemnify and hold Rice Lake harmless against any loss resulting from infringement of patents or trademarks, or from claims of such infringements and shall pay all legal and defense costs incurred by Rice Lake in the defense of such actions.

5. Software

Unless specifically otherwise stated, any and all software associated or part of any product sold, loaned on trial or demonstration to the customer is to be considered proprietary to Rice Lake. The customer agrees not to duplicate for distribution or to sell or distribute in any way without the prior written consent of Rice Lake.

6. Changes and Cancellation: Rejection, Claims

(a) Orders placed with Rice Lake are not subject to cancellation, change or reduction in amount or suspension of deliveries except with Rice Lake’s consent and upon terms that indemnify Rice Lake against loss. Unless confirmed in writing, all verbal agreements are void.

(b) Rice Lake will not be responsible for changes in design, deliveries or other instructions, unless they are furnished in writing. The customer agrees to pay for all tooling charges caused by changes in design or specifications.

(c) Samples submitted shall be deemed approved unless written rejection is received within two weeks of submission.

(d) Manufactured parts will be shipped and billed as they are produced.

Terms and Conditions

(e) Claims for shortage or rejections for defects must be made within 10 days of receipt of goods. Credit will be rendered on such defective parts after we have had an opportunity to inspect them, provided they are returned to our factory, transportation charges prepaid, within 30 days, and provided they have not been altered or defaced in any way.

7. Tooling and Designing

(a) In consideration of the engineering service necessary in the designing of jigs, fixtures and tooling not being charged for, but being quoted on the basis of labor and material only, and not at their fair market value, such jigs, fixtures and tooling shall remain in our possession for at least one year. Thereafter, the customer desiring delivery of such jigs, fixtures and tooling shall pay an engineering charge of 50 percent of the original price of said jigs, fixtures and tooling and accept same as-is.

(b) When requested, we will submit suggestions concerning design and construction of parts, but we will not accept responsibility of liability for the practicability of these suggestions if adopted by the customer.

8. Delivery and Adjustment to Price

(a) If the customer requests that the goods be manufactured and shipped on a date (or dates) earlier than originally agreed to by Rice Lake and the customer, and Rice Lake agrees to the earlier date (or dates), any increase in the cost of performance incurred by Rice Lake resulting from earlier manufacture and shipment will be included in an adjustment of the purchase price to be made by Rice Lake and will be paid by the customer.

(b) Should shipments be held beyond scheduled date for convenience of the customer, goods will be billed and charges will be made for warehousing, trucking and other expenses incident to such delay. Reasonable and sufficient care is taken by Rice Lake in crating its goods. Rice Lake cannot be held responsible for breakage after having received "in-good-order" receipts from the transportation carrier. All claim for loss and damage must be made by the customer to the carrier, but we will assist insofar as practical in securing satisfactory adjustment of such claims.

9. Payment and Liens

(a) All invoices shall be due and payable when submitted for payment in accordance with the revisions of Rice Lake terms. No withholding of funds, back charges or credits against amounts otherwise due to Rice Lake will be permitted unless specifically agreed to in writing by Rice Lake. Settlement of any amounts due to the customer will be negotiated as separate items and not as offsets against amounts otherwise due to Rice Lake from the customer for products sold hereunder.

(b) Any unpaid account for work done shall constitute a lien on any jigs, fixtures, manufactured parts and raw materials in Rice Lake possession. In the event any account remains open and unpaid for 90 days, Rice Lake reserves the right to use the customer's jigs and fixtures to make parts therefrom, and to sell or dispose of manufactured parts and raw materials.

(c) The customer shall not assign or transfer any rights or obligations arising from this proposal, or monies payable thereunder, without the prior written consent of Rice Lake, and any such assignment or transfer made without such written consent shall be deemed null and void.

10. Additional Provisions

(a) Errors—stenographic and clerical errors are subject to correction.

(b) These terms and conditions constitute the entire contract between the customer and Rice Lake, transcending any oral arrangements or representations which may be inconsistent therewith.

(c) This quotation is made under and shall be governed by the laws of the state of Wisconsin.

11. Resale of Rice Lake Weighing Systems Products

In order to ensure compliance with the U.S. Export Administration Regulations we ask you to comply with the following:

(a) The customer shall not export or re-export Rice Lake Weighing Systems products, either directly or indirectly, in contravention of any applicable law, statute or regulation and will first obtain any required licenses or authorizations from the relevant government authority when necessary as prescribed by law.

(b) The customer confirms that it is familiar with and complies with the relevant national and international export control regulations and embargo regulations. The customer furthermore confirms that it is in particular familiar with and complies with the U.S. Department of Commerce, Export Administration Regulations; U.S. Department of Treasury, OFAC Sanctions; the U.S. Department of Defense, ITAR requirements and the U.S. Department of State regulations.

(c) If deemed necessary, Rice Lake Weighing Systems, in individual cases may make further requests from the customer for information required for export compliance.

(d) Should it be necessary for the customer to obtain an export license from the appropriate authorities pursuant to the aforementioned regulations, the customer shall apply for such a license autonomously and at their own expense.

The foregoing warranties are exclusive and in lieu of all other express and implied warranties whatsoever, including but not limited to implied warranties of merchantability and fitness for a particular purpose. Rice Lake shall not be subject to any other obligations or liabilities whatsoever with respect to parts manufactured or supplied by Rice Lake or services rendered by it.

Anything herein to the contrary notwithstanding, Rice Lake shall not be liable for incidental and consequential damages, and in substitution for all remedies which the customer may have under any applicable law. The customer's sole and exclusive remedy against Rice Lake for any breach of warranty or any other breach relating to goods delivered pursuant hereto shall be for repair or replacement (at Rice Lake's option) of the goods or parts effected by such breach.

Warranty and Limitation of Liability

Standard Product Limited Warranty

Rice Lake Weighing Systems (Rice Lake) warrants that all Rice Lake brand equipment and systems properly installed by an Authorized Reseller or original equipment manufacturer (OEM) will operate per written specifications as confirmed by the authorized reseller/OEM and accepted by Rice Lake. All systems and components are warranted against defects in materials and workmanship for one (1) year from the date of shipment from Rice Lake, unless otherwise stated in the product catalog or manual. Rice Lake warrants that the equipment sold here under will conform to the current written specifications authorized by Rice Lake. Rice Lake warrants the equipment against faulty workmanship and defective materials. If any equipment fails to conform to these warranties, Rice Lake will, at its option, repair or replace such goods returned within the warranty period subject to the following conditions:

Upon discovery by the Customer of such nonconformity, Rice Lake will be given prompt written notice with a detailed explanation of the alleged deficiencies.

Individual electronic components returned to Rice Lake for warranty purposes must be packaged to prevent electrostatic discharge (ESD) damage in shipment. Packaging requirements are listed in the publication, "Protecting Your Components From Static Damage in Shipment," available from the Rice Lake Equipment Return Department.

Examination of such equipment by Rice Lake confirms that the non-conformity actually exists, and was not caused by accident, misuse, neglect, alteration, improper installation, improper repair, or improper testing. Rice Lake shall be the sole judge of all alleged non-conformities.

Such equipment has not been modified, altered, or changed by any person other than Rice Lake or its duly authorized repair agents.

Cutting the load cell cable will void the warranty.

Rice Lake will have a reasonable time to repair or replace the defective equipment. The Customer is responsible for shipping the product to Rice Lake. Rice Lake is responsible for shipping the product back to the Customer.

In no event will Rice Lake be responsible for travel time or on-location repairs, including assembly or disassembly of equipment. Nor will Rice Lake be liable for the cost of any repairs made by others.

On all intrinsically safe equipment, any field repair or modifications voids any and all warranties expressed or implied and void F.M. approval.

Any loose hardware, screws, washers or non-ESD bags of hardware stored inside indicator will void warranty. This could cause harm to repair technician or damage CPU board.

If just the board is sent in for repair, the serial number of the product the board is from should accompany the board.

These warranties exclude all other warranties, expressed or implied, including without limitation warranties of merchantability or fitness for a particular purpose. Neither Rice Lake nor the authorized reseller will, in any event, be liable for incidental or consequential damages at the point of use. Rice Lake and the Customer agree that Rice Lake's sole and exclusive liability here under is limited to repair or replacement of such goods. In accepting this warranty, the Customer waives any and all other claims to warranty.

Should the seller be other than Rice Lake, the Customer agrees to look only to the seller for warranty claims. No terms, conditions, understanding, or agreements purporting to modify the terms of this warranty shall have any legal effect unless made in writing and signed by a corporate officer of Rice Lake and the Customer.

Carrier Product Damage

As part of our commitment to customer satisfaction and in accordance with ISO 9001 standards, we make every attempt to pack our products so they will arrive in new condition. Occasionally due to rough handling or carelessness, product may arrive in a damaged condition. When this happens, do not assume that the shipment left Rice Lake in that condition or that the original packing was not sufficient.

The receiver, whether it is the authorized reseller or their Customer, is responsible for making a notation of damaged or missing items when signing the carrier's delivery receipt. If you or your Customer are not sure whether there is damage, we suggest adding a statement "CONDITION UNKNOWN" to the delivery receipt. In the event that damage or missing items are not properly documented at time of receipt, the carrier is relieved of responsibility and the receiver is then responsible for the cost to get the product back to new condition.

After the damage or shortage has been properly noted with the carrier, contact Rice Lake immediately and keep all the original packaging material for inspection by the carrier's representative. It is also helpful in the claim process to take pictures of the condition of the packaging and damage.

When drop-shipping items to your Customers, it is imperative that you advise them of their responsibility in accepting shipments from common carriers. Even if the equipment is not expected to be installed or used for a period of time, the shipment must be inspected at time of receipt in order to preserve their rights for making a claim.

Custom Software Limited Warranty

Rice Lake Weighing Systems (Rice Lake) warrants that (a) the software will perform in accordance with the specification and accompanying written endorsement by the Customer for a period of 90 days from the date of receipt; (b) any hardware accompanying the software will be free from defects in materials and workmanship under normal use and service for a period of one (1) year from the date of shipment from Rice Lake; and (c) the Customer should perform inspection and testing of software products prior to installation.

This limited warranty is void if failure of the software or hardware has resulted from accident, abuse, misapplication, or incorrect Customer specification. Any replacement software will be warranted for the remainder of the original warranty period or 30 days, whichever is longer.

If the software fails to conform to these warranties, Rice Lake will, at its option, repair or replace such goods returned within the warranty period subject to the following conditions:

Upon discovery by the Customer of such nonconformity, Rice Lake will be given prompt written notice with a detailed explanation of the alleged deficiencies.

Examination of software by Rice Lake confirms that the nonconformity exists, and was not caused by accident, misuse, neglect, alteration, improper installation, improper repair, improper testing, or incorrect Customer specification. Rice Lake shall be the sole judge of all alleged non-conformities.

Rice Lake will have a reasonable time to repair or replace the software. The Customer is responsible for shipping charges both ways.

In no event will Rice Lake be responsible for travel time or on-location repairs, including assembly or disassembly of equipment. Nor will Rice Lake be liable for the cost of any repairs made by others.

Warranty and Limitation of Liability

These warranties exclude all other warranties, expressed or implied, including without limitation warranties of merchantability or fitness for a particular purpose. Neither Rice Lake nor the authorized reseller will, in any event, be liable for incidental or consequential damages at the point of use.

Rice Lake and Customer agree that Rice Lake's sole and exclusive liability here under is limited to repair or replacement of such goods. In accepting this warranty, the Customer waives any and all other claims to warranty.

Should the seller be other than Rice Lake, the Customer agrees to look only to the seller for warranty claims.

No terms, conditions, understanding, or agreements purporting to modify the terms of this warranty shall have any legal effect unless made in writing and signed by a corporate officer of Rice Lake and the Customer.

Return Policies

Our commitment to our Customers states that if any standard product purchased from Rice Lake does not work, or if the incorrect product is shipped, **return it in its original shipping carton with all accessories in "like new" condition** for full credit or replacement within 30 days of purchase. **Electronic components returned to Rice Lake must be properly packaged to prevent electrostatic discharge (ESD) damage in shipment.** Packaging requirements are listed in the publication, "Protecting Your Components from Static Damage in Shipment," available online or from our Returns Department. This policy and the 30-day limit also apply to any products drop-shipped directly from the manufacturer.

Please note that if an incorrect quantity of product was shipped, Rice Lake must be contacted within 10 days of the purchase. Upon notification, we will immediately correct the situation.

A restocking charge will apply if equipment is not in like-new condition.

The restocking charge is directly proportional to the amount of time and material required to return the item to resalable condition—we will make every effort to do this quickly and economically. Equipment that has been abused and/or shows signs of excessive wear and cannot be reconditioned and resold will not be accepted for return or credit after excessive wear or has been modified.

As Applied to Drop Shipments

All Rice Lake return guidelines apply to products drop-shipped directly from the manufacturer. If a perceived error occurs, Rice Lake will investigate to the best of our ability to determine if the error occurred prior to shipping, during shipping, or at the end user site. If our records and subsequent investigation indicate that the shipment was correct when it left our factory, our responsibility extends only to the authorized reseller, not their end user. Our standard product warranty notes that our coverage extends only to equipment and systems **properly installed by an authorized reseller.**

Obtaining an RMA

A return authorization number (RMA) is required for all materials being returned to Rice Lake for credit. Flat rate repairs require purchase orders at time of RMA issuance. When returning equipment for repair or warranty reimbursement consideration, these simple steps will help to expedite your request:

1. Call Rice Lake's Returns Department.
2. Please have your customer number and both the item description and problem for a repair.
3. Please have the original sales order or invoice number for items to be returned for credit or warranty. NOTE: See return policy

4. An RMA number will be given for eligible returns. This RMA number may also be faxed or emailed per your request.

Return Shipments Outside the United States for Repair, Warranty, Calibration or Other Services and Re-export

For shipment to the USA:

1. The commercial invoice must include the following statement:
 - i. "These goods are being returned for maintenance under"
 - ii. Goods Made in the USA -- "HTS 9801.00.1012"
 - iii. Goods NOT made in the USA -- "HTS 9801.00.2500"
2. The commercial invoice must list items individually and include the fair market value of the item based on its present condition for customs purposes only.
3. Please reference original Rice Lake commercial invoice number and date item was purchased if applicable.
4. Please note that failure to follow these procedures may cause delay and will certainly incur extra charges that will NOT be absorbed by Rice Lake.

Return Shipments Outside the United States Other Than for Repair or Service Work Not Being Returned

For shipment to the USA:

1. The commercial invoice must include the following statement:
 - i. Goods Made in the USA -- "HTS 9801.00.1045"
 - ii. Goods NOT made in the USA -- "HTS 9801.00.2500"
2. The commercial invoice must list items individually and include the fair market value of the item based on its present condition for customs purposes only.
3. Please reference original Rice Lake commercial invoice number and date item was purchased if applicable.
4. Please note that failure to follow these procedures may cause delay and possible reduction in your refund.
5. Please be advised that you may qualify for a refund of your duties and should contact your local customs authority for instructions and forms.

Special Order, Modified, Non-Catalog or Non-Stock Items

Due to the added resources and difficulty in reselling special or non-standard products, returns or credit are not allowed for special order equipment, special software programs, equipment physically modified or altered in the field, discrete electronic components, relays, manuals, or opened software packages.

Warranty and Limitation of Liability

Calibration Test Weights

All weights returned for credit will be assessed a restocking charge because of the required inspection and verification. Credit is not allowed for serialized weights, calibration or traceable services performed on weights.

No returns will be accepted for items that are specifically modified for the Customer's requirements. Examples of such modifications may include, but not necessarily limited to:

1. Weights that have been specifically built to the customer's specifications.
2. Standard product specifically modified to the customer's specifications.
3. Standard product engraved with serial numbers at the customer's request.
4. Laboratory procedure charges.
5. Laboratory documentation fees.

Balances

Balances returned for credit within 30 days of purchase may be subject to a restocking fee if assessed by balance manufacturer.

Balance Repair Policy and Rates

We offer repair support on the following balance models:

- All Rice Lake brand models: Once we receive the equipment and the RMA form, an estimate will be prepared.

A minimum charge of one hour will apply. All balance repairs are covered by a 90-day limited warranty on parts and workmanship performed and noted under the scope of the specific repair. Balances must be packaged to adequately protect them from damage in transit. Please refer to "How to Prepare a Balance for Shipment" available on Rice Lake's website and from our Returns Department.

How to Prepare a Balance for Shipment

The best and most effective method for shipping a balance at any time and for any reason is to use the original manufacturer's packaging materials and subsequently double box it as described below. Teach your Customers to retain the packing set. Please remember that due to the nature of the equipment, new packaging materials can be very expensive.

In the event that the original manufacturer's packaging materials are not available, follow these instructions for top loading balances.

1. Remove the weighing platform cover, support buttons, weighing platform, floor plate and other devices installed in the weighing chamber. Pack these pieces individually in bubble wrap and tape the wrapping closed. Follow this same procedure for AC adapters and power cords. Please note that AC adapters and power cords are necessary to adequately evaluate the problem.
2. Examine the device (refer to the operating instructions) and if necessary, re-install or tighten any shipping screws/retaining devices to prevent damage to the weighing mechanism during shipment.
3. If the floor plate is not removable, ensure it is securely in place and cannot come loose during shipment, even if the balance is inverted. Do NOT invert the balance to test the security of the floor plate.
4. Clean the device of any loose debris or potential contaminants to our testing facility.
5. Prepare and sign a Statement of Decontamination (form #0679). This form MUST be included in a separate packing list envelope on the outside of the box with the "Statement of Decontamination Form" statement clearly visible.
6. Using Scotch tape or "speed" tape, tape all the glass doors on the device CLOSED. Be sure the tape is securely affixed and will not come off during shipment. Please note that on some devices, the glass breeze-break around the weighing chamber can actually be disassembled and packed separate prior to shipment. Refer to the manufacturer's operating instructions. If this is a feature of the device being returned, disassemble the breeze break and pack it in its own packing material and box.
7. Use a large box that will provide a minimum of 3 inches of space around the device for loose-fill packing material.
8. Place a padding of foam or Styrofoam (at least 1 inch thick) at the bottom of the box.
9. Place the balance in a large plastic bag and seal the bag closed.
10. Please put the device on top of the foam padding or Styrofoam from step 8 above.
11. Ensure that there is at least three inches of clearance between the top of the balance and the top of the box.
12. Using generous amounts of anti-static loose-fill packing material, fill all the spaces around the balance. Shake the box to cause the material to settle and add additional loose fill as necessary.
13. Place the small box containing all the items from step 1 above on top of the loose fill covering the balance. Add additional loose fill to completely cover all items within the box.
14. Double pack this box in another box that will again provide an additional two inches of space around the inner box. Fill all existing space between the inner and outer box with copious amounts of anti-static loose fill packing material.
15. Seal the box and include all the necessary documentation on the outside of the box. Don't forget the Decontamination Form (form #0679) from step 5 above.

Warranty and Limitation of Liability

Repair Service Policies

Our Service Department is staffed Monday through Friday from 6:30 A.M. to 6:30 P.M., and Saturday from 8:00 A.M. to noon, Central time. For those utilizing the conveniences of the Internet, we have an email address dedicated to technical support. Please contact Rice Lake at service@ricelake.com for answers to your technical questions and the status of repair products during normal business hours.

We provide quality and timely repairs for the products we sell. Flat rate repair is offered for selected models of indicators, printers and remote displays. Prior to returning a product for repair, our Returns Department will work with you to determine some key factors that will help Rice Lake better serve you. Please provide the following via phone to extensions 5348 or an RMA form.

- **Customer Number:** Without a customer number we cannot issue an RMA number.
- **Ship-to Address:** Your customer number will bring up the bill-to address. You must inform Rice Lake of the ship-to address if it is different than the bill-to address.
- **Original sales and invoice orders: Required on warranty claims.**
- **Freight Type:** Unless stated otherwise, we ship the device back to you utilizing the same freight type in which we received it. If Rice Lake is responsible for freight charges, the carrier will be selected at the sole discretion of Rice Lake.
- **Definition of Product and Problem: Please provide as much detail as possible regarding the type of product, application and problem.**
- **Purchase Order Number for Flat Rate Repair:** Once we receive the equipment and the RMA, equipment for flat rate repair will be processed immediately. Other equipment will be evaluated and a minimum evaluation charge will apply (contact the factory for exact pricing).

You may be asked about the possibility of a new replacement product. It may be in your customer's best interest to explore the option of purchasing a new product if the repair will exceed 50 percent of authorized reseller net price, since new products carry full-warranty benefits.

Please note that our hourly service rate on all current Rice Lake products. Contact the factory for exact pricing. There is a 120-day limited warranty on parts and workmanship performed and noted under the scope of the specific repair.

California Proposition 65

Rice Lake Weighing Systems Statement

Proposition 65 requires businesses to inform Californians about exposures to chemicals that are known to cause cancer, birth defects or other reproductive harm. These chemicals may be in the products you purchase, or they may be exposed to you at home, at the workplace or within the environment. Proposition 65 enables Californians to make informed decisions about their exposures to these chemicals.

Rice Lake Weighing Systems wants to be proactive in regards to Proposition 65 and provide information about the products we produce, distribute and use to manufacture equipment we sell.

We are providing this warning based on the knowledge that one or more chemicals included in the California Proposition 65 list known to cause cancer, birth defects or other reproductive harm may be present in Rice Lake Weighing Systems products and workplaces.



WARNING: Chemicals listed in California Proposition 65 known to cause cancer, birth defects or other reproductive harm may be present only in trace amounts or contained within Rice Lake Weighing Systems products and proper encapsulation equipment.

This warning is provided out of an abundance of caution to enable you to be an informed consumer.

More information about California Proposition 65 can be found at www.P65Warnings.ca.gov

Ingress Protection (IP) Ratings

For load cell sealing techniques, Rice Lake Weighing Systems uses the Ingress Protection (IP) rating system. We find the IP numbers and their definitions are suitable for the classification of load cells and only apply IP numbers to such cells. The IP numbers on a load cell further specify the treatment a specific cell can endure in environments more severe than simple washdown.

All load cell cables should be run through conduit to increase protection against moisture ingress.

Example: Protection level offered by an IP67 rated product

IP 67

Protection against solid objects

First number (in this case 6)

- 0** No protection
- 1** Protected from solid objects up to 50 mm (e.g., accidental touch by hands)
- 2** Protected from solid objects up to 12 mm (e.g., fingers)
- 3** Protected from solid objects more than 2.5 mm (e.g., tools and small wires)
- 4** Protected from solid objects more than 1 mm (e.g., small wires)
- 5** Protected from dust; limited entrance (no harmful deposit)
- 6** Totally protected from dust

Protection against liquids

Second number (in this case 7)

- 0** No protection
- 1** Protected from vertically-falling drops of water (e.g., condensation)
- 2** Protected from direct sprays of water up to 15° from vertical
- 3** Protected from direct sprays of water up to 60° from vertical
- 4** Protected from water sprayed from all directions; limited entrance allowed
- 5** Protected from low pressure jets of water from all directions; limited entrance allowed
- 6** Protected from strong jets of water (e.g., for use on ship decks); limited entrance allowed
- 7** Protected from the effects of immersion between 15 cm and 1 m for 30 minutes
- 8** Protected from extended periods of immersion under pressure

IP Numbers with Hermetically Sealed (HS) or Environmentally Protected (EP) Ratings

Rating	Protection
EP	Dust proof, not protected from moisture or water
IP65	Dust proof, protected from splashes and low-pressure jets
IP66	Dust proof, protected from strong water jets
IP67	Dust proof, protected from temporary immersion in water 1 meter deep for 30 minutes
IP68	Dust proof, protected from continuous immersion in water under more severe conditions than IP67
IP66/68	Dust proof, protected from strong water jets and/or constant immersion
IP69K	Dust proof, protected from high pressure washing and steam cleaning

Conversions

Abbreviation	Description	Conversion
kg	1 kilogram kilo 10 ³	1000 grams
mg	1 milligram milli 10 ⁻³	0.001 g
µg	1 microgram micro 10 ⁻⁶	0.000 001 g
µlb	1 micro pound micro 10 ⁻⁶	0.000 001 lb

Multiplication Factor	Prefix	Symbol
1,000,000,000 = 10 ⁹	giga	G
1,000,000 = 10 ⁶	mega	M
1,000 = 10 ³	kilo	k
100 = 10 ²	hecto	h
1 = 1		
0.01 = 10 ⁻²	centi	c
0.001 = 10 ⁻³	milli	m
0.000001 = 10 ⁻⁶	micro	µ
0.00000001 = 10 ⁻⁹	nano	n

Abbreviation	Description	Conversion
T	Tera	1,000,000,000,000
G	Giga	1,000,000,000
M	Mega	1,000,000
k	kilo	1,000
h	hecto	100
dK -or- da	deca	10
	metre, gram, liter, second, celcius	
d	deci	.1
c	centi	.01
m	milli	.001
µ	micro	.000,001
n	nano	.000,000,001
p	pico	.000,000,000,001

Unit	"kg" RELATIONSHIP	"g" RELATIONSHIP
Nanogram (ng)	10 ⁻¹² 0.000000000001kg	10 ⁻⁹ 0.000000001g
Microgram (µg)	10 ⁻⁹ 0.000000001kg	10 ⁻⁶ 0.000001g
Milligram (mg)	10 ⁻⁶ 0.000001kg	10 ⁻³ 0.001g
Gram (g)	10 ⁻³ 0.001kg	1g
Kilogram (kg)	1kg	10 ³ g 1000g
Ton (t)	10 ³ kg 1000kg	10 ⁶ g 100,000g

Shipping Information

Signed. Sealed. Delivered. It's Yours!

On average, regardless of carrier, 2% of all freight is damaged in transit. Don't let the delivery person slip away. And don't get left holding the bag.

Rice Lake merchandise is packaged carefully to arrive at your location on time, intact and in perfect working order. We don't ship damaged goods, and we work with many of the most reputable national carriers. But know this—anytime a package is sent, an average of 2 out of 100 will be mishandled. To be sure your business doesn't take the hit for someone else's mistake—INSPECT before you sign.

Whether or not the product itself has been damaged, remember—your signature accepts the delivery as is, releasing the carrier and supplier of all liability, unless you take action:

- Make note of any damage to the packaging, no matter how slight, including re-packaging, water damage, scratches to paint, etc. Take photos if possible to back up any necessary claims.
- Do not accept or sign for as "unchecked"—this is not an acceptable disclaimer.
- Where damage to contents is obvious, take photos and refuse the shipment.

Notify your supplier immediately with the claim number provided by the driver. Noting the condition of your delivery upon receipt is the only recourse when making a damage claim. Follow these steps and you'll get replacement merchandise faster, keep costs down and ensure the carrier is held responsible for their mistakes; not you, and not your supplier.

Same Day Services

These services do not carry the same service guarantees that standard delivery schedules do and are subject to availability.

Small Parcel Services

We ship with internationally recognized parcel carriers based on delivery time and services offered.

Determining Dimensional Weight for Small Parcel Shipments for Air and Ground

When shipping via air services, couriers require that the shipping weight be determined by the greater of the actual weight of the boxed product or its dimensional shipping weight. The formula for calculating dimensional shipping weight is as follows:

Domestic shipments via Ground or Air: $L \times W \times H/139$.

International air shipments $L \times W \times H/139$.

Please note: Rice Lake Weighing Systems takes the added precaution of double-boxing some of our electronic products and balances. This may result in higher dimensional weight charges by the carrier. Even with this added precaution, we suggest that you always ship high precision and fragile products via air services to reduce excessive handling.

Less Than Truck Load (LTL)

Full service LTL coverage for the continental United States, Puerto Rico, Canada and Mexico.

Note: A standard LTL delivery is considered to be one that ships from either a company or partner dock to arrival at a standard commercial address with disposition of the goods at the rear of the truck to enable off loading

by material handling equipment provided by the consignee at either ground level or via loading dock. Allied to this, the freight in question should be palletized and secured in a way to facilitate the safe handling of the freight with no one dimension over seven feet, six inches.

Any LTL delivery falling outside of this criteria may well accrue accessorial charges levied by the carrier in line with their tariff rules. It is recommended that any potential accessorial cost are discussed at the time of order placement so that these costs can be billed appropriately at the time of shipment. If this is not the case, Rice Lake reserves the right to charge the customer retrospectively for any accessorial costs incurred during the delivery process.

Accessorial charges include, but are not limited to the following:

Lift gate, call for appointment and guaranteed delivery: Day and by 10:30 a.m. (where available). Excessive length, inside delivery

NOTE: To inside of first threshold crossed only, high cost delivery areas such as government sites and mines, re-delivery, re-consignment, residential and restricted access shipments. All prices are available on request.

Full Truckload

Various truckload providers give us the ability to ship to the contiguous United States, Alaska, Canada and Mexico.

Forwarders (International Freight)

We can provide service through a forwarder of our choice, or select one of your preferred forwarders.

Air freight: All of our forwarders are internationally recognized brands.

Ocean freight: All of our forwarders are internationally recognized brands.

Shipping Information

FREIGHT SERVICES OFFERED	"SMALL PACK"	LTL	TRUCK LOAD
Nationwide Same Day Service	Y* and ***	Y*	N
Next Day (AM)	Y**	Y**	Y**
Next Day (END OF DAY)	Y	Y**	Y**
2 Day	Y	Y	Y
3 Day	Y	Y	Y
Ground	Y	Y	Y
Canada	Y	Y	Y
Mexico	Y	Y	Y
Express Freight (Air-over 150 lb)***	Y	Y	N
International (Sea)	Y	Y	Y
International (Air)	Y	Y	N

* Subject to cost/distance ** Subject to distance *** Subject to flight availability and proximity of nearest airport

Rice Lake Weighing Systems Freight Claims Procedure

Incidents can happen anytime between a package's departure from Rice Lake's loading dock and the time you receive it. For that reason, we are asking you to follow the procedures below when receiving a shipment.

The Bill of Lading (BOL) or Delivery Receipt (D/R) is the only record of the product's condition when it arrives at your site. If you do not inspect a shipment before signing, you are essentially waiving the right to collect on a damage claim regardless of whether the damage is visible or concealed. Your signature on a delivering carrier's BOL or D/R constitutes acceptance of the merchandise "as is." This proof is essential in filing a claim and holding the responsible parties accountable for items damaged or missing while in transit. Remember, once you sign, the goods and the responsibility are yours.

Receiving a Shipment

- Check immediately for possible damage during shipment. Inspect, examine and inventory your delivery as it is unloaded.
- Open cartons and containers. Any suspicion of damage or shortage must be noted on the BOL or D/R. This information must include the item, discrepancy and condition of the item in question. If this is NOT noted, the liability to prove the damage was done by the delivering carrier is your responsibility.
- The driver cannot leave your receiving dock until the BOL or D/R is signed, regardless if they are behind schedule or not. Do not be intimidated by the driver.

Damaged Shipment

- **Discovered Damage:** If the box, crate or merchandise is visibly damaged, beyond what you would consider to be normal shipping wear and tear, refuse the delivery and request a Return Authorization Number from the driver in order for the shipment to be sent back to its origin at no charge.
- **Concealed Damage:** Immediately document and photograph the damage and packaging. Keep all crating and packaging material with

the damaged item(s) for inspection by the company's claim inspector until told to either return or dispose of the item(s). The item should be moved minimally; only to an area where it can be inspected by the carrier or their agent.

- Keep a second copy of the BOL or D/R noting the damage and the driver's signature.
- Call your Rice Lake Weighing Systems customer service representative to report the shortage and/or damage. Ideally, the call should be made before the driver leaves the site.

At this point, a claim for concealed damage will be started and an inspection will be requested. The inspector will determine if the damage was possibly caused by the carrier. A report and claim must be filed with the carrier within seven days after delivery. The sooner concealed damage is discovered and reported, the better.

Small Parcel Shipments

In general, it is the policy of small parcel carriers to NOT deliver damaged packages but rather take them back to the distribution center for evaluation. HOWEVER, that does not always happen. Occasionally if the package is deemed to be in suitable condition, it will be re-taped and delivered to the consignee. If damage is noticed while still at the distribution center, a notation should have been entered into the system.

If you receive a package that appears to be damaged, you can either refuse as damaged or you can accept the damaged package and report the damage (immediately) to your customer service representative here at Rice Lake with the tracking number. They will, in turn, contact the relevant team member from their support group so the claims process can be started. It should be noted that **Drivers do not normally note the package was damaged until it is brought back to the distribution center and a clerk notes it as damaged.**

Weight Recalibration Request

To receive a quote for recalibration, return this form via mail, fax, or e-mail to orderdesk@ricelake.com
 For questions, please contact our weights specialists at 800-472-6703 ext. 6655.

**To help us serve you better, please complete the required fields denoted with an asterisk.*

<p>*RLWS Account #: _____</p> <p>*Bill to: _____</p> <p>Address: _____</p> <p>City: _____</p> <p>State: _____ Zip: _____</p> <p>Contact: _____</p> <p>Phone: _____ Fax: _____</p> <p>Email: _____</p>	<p>*Shipping Method: _____</p> <p>Shipping Account #: _____</p> <p><input type="checkbox"/> (Shipping address is different from billing address.)</p> <p>Ship to: _____</p> <p>Address: _____</p> <p>City: _____</p> <p>State: _____ Zip: _____</p> <p>Country: _____</p>
---	---

***Payment Information**

Purchase Order #: _____ **Contact Number:** _____

***Certification/Report Information**

Contractor: _____ Client: _____

***Recalibration Date:** No Yes, number of years: _____

Select type of documentation (only one per quote request):

- Certificate of Weight Calibration—ISO/IEC 17025 accredited. Traceable to NIST. Classes ASTM 00-7, OIML E1, E2, F1, F2, M1, M2, M3, NIST Class F
- Certificate of Weight Calibration—Non-accredited. Traceable to NIST. Classes ASTM 1-3, OIML F1, F2

Range	Density	Serial #	Number of Weights	Number of Reports	Class	Recalibration Date	Documentation Type
				<input type="checkbox"/> Individual report each weight			<input type="checkbox"/> Accredited
				<input type="checkbox"/> All weights on one report			<input type="checkbox"/> Non-Accredited
				<input type="checkbox"/> Individual report each weight			<input type="checkbox"/> Accredited
				<input type="checkbox"/> All weights on one report			<input type="checkbox"/> Non-Accredited
				<input type="checkbox"/> Individual report each weight			<input type="checkbox"/> Accredited
				<input type="checkbox"/> All weights on one report			<input type="checkbox"/> Non-Accredited
				<input type="checkbox"/> Individual report each weight			<input type="checkbox"/> Accredited
				<input type="checkbox"/> All weights on one report			<input type="checkbox"/> Non-Accredited

For shipment originating outside the USA, weights are being returned for maintenance under:

- Made in USA (HTS 9801.00.1012)
- Not made in the USA (HTS 9801.00.2500)

Have these weights been exposed to hazardous materials? **Yes No

Signature: _____ Title: _____

Print Name: _____ Date: _____

***If yes, please complete Statement of Decontamination form and include a copy of this form and your order along with your weights. If weights have been exposed to hazardous materials, service will not be performed without a completed Decontamination Form.*

The uncertainty of measurement is included in the decision rule in determining pass/fail criteria of the Maximum Permissible Error (MPE).

Metrology Lab Locations:

TEL: 800-472-6703 • FAX: 715-234-6967

RICE LAKE: 230 W. Coleman St. • Rice Lake, WI 54868 • USA
CONCORD: 1400 Willow Pass Court, • Concord, CA 94520 • USA



An ISO 9001 registered company © 2021 Rice Lake Weighing Systems
 #0048 Rev 20, 03/21

Statement of Decontamination

All weights exposed to hazardous materials that are returned to Rice Lake Weighing Systems are required to have a completed decontamination form. By accepting authorization to return this product, the customer assumes all responsibility and liability for biological, chemical and radioactive decontamination and cleaning. Rice Lake Weighing Systems will not accept any delivery which does not include a completed decontamination form.

Customer Information

Company: _____ Address: _____
Cust No: _____
Name: _____ City: _____
Phone: _____ State/Zip: _____
Email: _____ Country: _____

Product

Manufacturer: _____ Type: _____ Serial #: _____ Qty: _____
Manufacturer: _____ Type: _____ Serial #: _____ Qty: _____
Manufacturer: _____ Type: _____ Serial #: _____ Qty: _____
Manufacturer: _____ Type: _____ Serial #: _____ Qty: _____

List any exposure to hazardous fluids, gases or substances and attach copies of appropriate MSDS sheets

Please describe decontamination procedure or process used:

- ETO Biocides Irradiation Manual Disassembly and Cleaning
 None Required Other _____

I certify that the aforementioned items are free of any radioactive, biohazardous, or otherwise dangerous substances/gases and are safe for human handling. By signing this form, I indicate that I have read and understand Rice Lake Weighing Systems' decontamination policy above and have taken any and all necessary steps to assure this product will not pose a chemical, biological or radioactive threat.

Signature: _____ Title: _____

Print Name: _____ Date: _____

To minimize delays, please include a copy of this form and your order along with your weights to be calibrated. Service will not be performed without a completed Decontamination Form.

Metrology Lab Locations:

RICE LAKE: 230 W. Coleman St. • Rice Lake, WI 54868 • USA

TEL: 800-472-6703 • FAX: 715-234-6967

CONCORD: 1400 Willow Pass Court, • Concord, CA 94520 • USA

TEL: 800-672-1440 • FAX: 925-798-8905



www.ricelake.com/precision

An ISO 9001 registered company © 2016 Rice Lake Weighing Systems
Specifications subject to change without notice.

#0047 Rev 4 1/19

A series of horizontal lines for writing, including a red line at the top and bottom.



ASTM

Mass Reference Standards

Applications:

- Calibrating Class I and II balances
- Calibrating ASTM Class 4, 5 and 6 weights
- Student laboratory use
- Rough weighing operations; Force measuring operations
- Tolerance testing
- Verification checks

Designs Available:

- Type I design (one piece) for Class 0
- Type II design (two piece screw-knob) for Classes 1-4 with sealing cavity for adjusting material

Product Configuration:

- Single weight
- Single weight kit: includes weight, case or vial and glove
- Weight set: includes weights, case and handling equipment
- Weight set configurations: 5-2-2-1 and 5-3-2-1 Example: (1) 50 g, (2) 20 g and (1) 10 g or (1) 50 g, (1) 30 g, (1) 20 g and (1) 10 g

Custom Configuration:

- Custom sets are available as built-to-order configurations to meet your specific requirements
- ASTM weight sets larger than 500 g or 1lb include a hardwood case with velvet-lined pockets
- Weight sets with the largest weight of 500 g include a precision-machined, polyvinyl, crush-resistant case

Features:

- Stainless steel polished finish
- Designed to meet ASTM E617 specifications; ASTM Class 0 weight sets and individual weights are not individually marked with their weight value or individually serialized per ASTM E617
- Nominal value marked on weights
- Serial numbers applied to case (weights may be marked with symbol)
- Density 7.95 g/cm³





Metric Single Weight with Case (Kits)

18 Range: 25 kg – 1 mg

Metric Single Weights

19 Range: 25 kg – 1 mg

Metric Single Weight with Case (Kits)

20 Range: 50 kg – 1 g

Metric Single Weights

22 Range: 50 kg – 1 g

Metric Single Weight with Case (Kits)

24 Range: 500 mg – 0.5 mg

Metric Single Weights

25 Range: 500 mg – 1 mg

Avoirdupois Single Weight with Case (Kits)

26 Range: 30 lb – 1/16 oz

28 Range: 0.001 lb – 1/32 oz

Avoirdupois Single Weights

30 Range: 50 lb – 1/16 oz

32 Range: 0.001 lb – 1/32 oz

Avoirdupois Single Weight with Case (Kits)

33 Range: 50 lb – 1/16 oz

Avoirdupois Single Weights

34 Range: 0.001 lb – 1/32 oz

Sets

35 Essential Weights

Metric Sets

36 Range: 500 g

38 Range: 20 g

40 Range: 50 g

42 Range: 100 g

44 Range: 200 g

46 Range: 300 g and 500 g

48 Range: 1 kg

50 Range: 2 kg

52 Range: 3 kg and 5 kg

54 Range: 10 kg

56 Range: 20 kg and 25 kg

58 Range: 2 lb through 50 lb

59 Range: 2 lb through 50 lb

MASS REFERENCE STANDARDS / METRIC SINGLE WEIGHT WITH CASE (KITS)

RANGE: 25 kg – 1 mg

Class 0

Cylindrical

Statement of Accuracy is not available.

Class 0 enclosed in case per requirements.

Nominal Value	Kit Part #	Price
25 kg	Consult	Consult
20 kg	45856	\$4,450.00
10 kg	45857	\$2,925.00
5 kg	45858	\$2,100.00
3 kg	45859	\$1,840.00
2 kg	45860	\$1,520.00
1 kg	45861	\$1,120.00
500 g	45862	\$685.00
300 g	45863	\$645.00
200 g	45864	\$600.00
100 g	45865	\$500.00
50 g	45866	\$470.00
30 g	45867	\$455.00
20 g	45868	\$455.00
10 g	45869	\$455.00
5 g	45870	\$395.00
3 g	45871	\$395.00
2 g	45872	\$395.00
1 g	45873	\$395.00

Certificate

Accredited
Included
Included
Included
Included
Included
Included
Included
Included
Included
Included
Included
Included
Included
Included
Included
Included
Included
Included
Included
Included
Included



Kits Include a Single Weight with Case and Glove

Class 0

Leaf (Milligram)

Statement of Accuracy is not available.

Class 0 enclosed in vial per requirements.

Nominal Value	Kit Part #	Price
500 mg	45874	\$305.00
300 mg	45875	\$305.00
200 mg	45876	\$305.00
100 mg	45877	\$305.00
50 mg	45878	\$305.00
30 mg	45879	\$305.00
20 mg	45880	\$305.00
10 mg	45881	\$305.00
5 mg	45882	\$305.00
3 mg	45883	\$305.00
2 mg	45884	\$305.00
1 mg	45885	\$305.00

Certificate

Accredited
Included
Included
Included
Included
Included
Included
Included
Included
Included
Included
Included
Included
Included
Included
Included
Included
Included
Included
Included
Included
Included

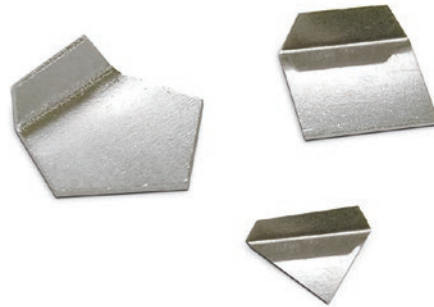
**Replacement Cases**

Main Cases		
Class 0		
Nominal Value	Part #	Price
25 kg - 1 mg	Consult	Consult

Accessories

Description	Part #	Price
Tweezer	11711	\$5.00
Premium tweezer	152414	\$43.00
Weight glove, white cotton	11714	\$6.75
Leaf weight cover	11755	\$43.00
Lifter bar	11747	\$21.00
Lifter bar with larger handle	11712	\$73.00
Weight forceps	50035	\$43.00
Tong assembly	50000	\$74.00

RANGE: 25 kg – 1mg

Class 0

Cylindrical

Statement of Accuracy is not available.
Class 0 enclosed in case per requirements.

Nominal Value	Part #	Price
25 kg	Consult	Consult
20 kg	46097	\$4,375.00
10 kg	46096	\$2,850.00
5 kg	46095	\$2,030.00
3 kg	46094	\$1,820.00
2 kg	46093	\$1,490.00
1 kg	46092	\$1,100.00
500 g	46091	\$660.00
300 g	46090	\$625.00
200 g	46089	\$580.00
100 g	46088	\$485.00
50 g	46087	\$435.00
30 g	46086	\$435.00
20 g	46085	\$435.00
10 g	46084	\$435.00
5 g	46083	\$375.00
3 g	46082	\$375.00
2 g	46081	\$375.00
1g	46080	\$375.00

Certificate

Accredited
Included
Included
Included
Included
Included
Included
Included
Included
Included
Included
Included
Included
Included
Included
Included
Included
Included
Included
Included
Included
Included



Cylindrical Weight

Class 0

Leaf (Milligram)

Statement of Accuracy is not available, and weight requires a case for shipping.
For special kits, single weights must ship in a case.
Single leaf weights must ship in a vial.

Nominal Value	Part #	Price
500 mg	46079	\$300.00
300 mg	46078	\$300.00
200 mg	46077	\$300.00
100 mg	46076	\$300.00
50 mg	46075	\$300.00
30 mg	46074	\$300.00
20 mg	46073	\$300.00
10 mg	46072	\$300.00
5 mg	46071	\$300.00
3 mg	46070	\$300.00
2 mg	46069	\$300.00
1mg	46068	\$300.00

Certificate

Accredited
Included
Included
Included
Included
Included
Included
Included
Included
Included
Included
Included
Included
Included
Included
Included

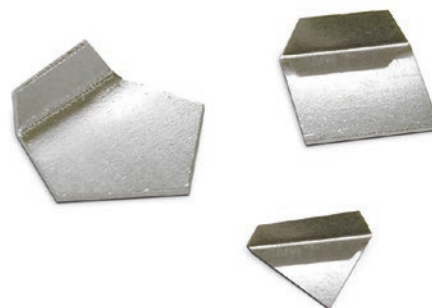

ASTM
PRECISION

OIML
PRECISION

BALANCE
CALIBRATION

STAINLESS
FIELD WEIGHTS

CAST IRON
FIELD WEIGHTS

ASTM
SPECIALTY

ACCESSORIES

Replacement Cases

Main Cases		
Class 0		
Nominal Value	Part #	Price
25 kg - 1mg	Consult	Consult

Accessories

Description	Part #	Price
Tweezer	11711	\$5.00
Premium tweezer	152414	\$43.00
Weight glove, white cotton	11714	\$6.75
Leaf weight cover	11755	\$43.00
Lifter bar	11747	\$21.00
Lifter bar with larger handle	11712	\$73.00
Weight forceps	50035	\$43.00
Tong assembly	50000	\$74.00

MASS REFERENCE STANDARDS / METRIC SINGLE WEIGHT WITH CASE (KITS)

RANGE: 50 kg – 1g

Class 1

Class 1 enclosed in vial/case per requirements.

Nominal Value	Kit Part #	Price
50 kg	Consult	Consult
25 kg	Consult	Consult
20 kg	82590	\$3,975.00
10 kg	82591	\$2,250.00
5 kg	82592	\$1,290.00
3 kg	82593	\$1,030.00
2 kg	82594	\$835.00
1 kg	82595	\$585.00
500 g	82596	\$250.00
300 g	82597	\$195.00
200 g	82598	\$185.00
100 g	82599	\$130.00
50 g	82600	\$125.00
30 g	82601	\$120.00
20 g	82602	\$115.00
10 g	82603	\$115.00
5 g	82604	\$115.00
3 g	82605	\$100.00
2 g	82606	\$100.00
1 g	82607	\$85.00

Optional Certificate

Accredited	Non-Accredited
Consult	Consult
Consult	Consult
\$145.00	\$80.00
\$145.00	\$80.00
\$145.00	\$80.00
\$145.00	\$80.00
\$145.00	\$80.00
\$125.00	\$60.00
\$125.00	\$60.00
\$125.00	\$60.00
\$125.00	\$60.00
\$55.00	\$45.00
\$55.00	\$45.00
\$55.00	\$45.00
\$55.00	\$45.00
\$55.00	\$45.00
\$55.00	\$45.00
\$55.00	\$45.00
\$55.00	\$45.00
\$55.00	\$45.00
\$55.00	\$45.00
\$55.00	\$45.00

Class 3

Class 3 enclosed in vial/case per requirements.

Weight	Kit Part #	Price
50 kg	Consult	Consult
25 kg	Consult	Consult
20 kg	82674	\$2,650.00
10 kg	82675	\$1,980.00
5 kg	82676	\$1,250.00
3 kg	82677	\$955.00
2 kg	82678	\$755.00
1 kg	82679	\$495.00
500 g	82680	\$235.00
300 g	82681	\$175.00
200 g	82682	\$165.00
100 g	82683	\$125.00
50 g	82684	\$115.00
30 g	82685	\$110.00
20 g	82686	\$100.00
10 g	82687	\$100.00
5 g	82688	\$73.00
3 g	82689	\$73.00
2 g	82690	\$73.00
1 g	82691	\$73.00

Optional Certificate

Accredited	Non-Accredited
Consult	Consult
Consult	Consult
\$145.00	\$80.00
\$145.00	\$80.00
\$145.00	\$80.00
\$145.00	\$80.00
\$145.00	\$80.00
\$125.00	\$60.00
\$125.00	\$60.00
\$125.00	\$60.00
\$125.00	\$60.00
\$125.00	\$60.00
\$55.00	\$45.00
\$55.00	\$45.00
\$55.00	\$45.00
\$55.00	\$45.00
\$55.00	\$45.00
\$55.00	\$45.00
\$55.00	\$45.00
\$55.00	\$45.00
\$55.00	\$45.00
\$55.00	\$45.00
\$55.00	\$45.00

Class 2

Class 2 enclosed in vial/case per requirements.

Nominal Value	Kit Part #	Price
50 kg	Consult	Consult
25 kg	Consult	Consult
20 kg	82632	\$2,675.00
10 kg	82633	\$2,160.00
5 kg	82634	\$1,250.00
3 kg	82635	\$985.00
2 kg	82636	\$770.00
1 kg	82637	\$505.00
500 g	82638	\$250.00
300 g	82639	\$185.00
200 g	82640	\$175.00
100 g	82641	\$130.00
50 g	82642	\$120.00
30 g	82643	\$110.00
20 g	82644	\$100.00
10 g	82645	\$100.00
5 g	82646	\$85.00
3 g	82647	\$85.00
2 g	82648	\$85.00
1 g	82649	\$85.00

Optional Certificate

Accredited	Non-Accredited
Consult	Consult
Consult	Consult
\$145.00	\$80.00
\$145.00	\$80.00
\$145.00	\$80.00
\$145.00	\$80.00
\$145.00	\$80.00
\$125.00	\$60.00
\$125.00	\$60.00
\$125.00	\$60.00
\$125.00	\$60.00
\$55.00	\$45.00
\$55.00	\$45.00
\$55.00	\$45.00
\$55.00	\$45.00
\$55.00	\$45.00
\$55.00	\$45.00
\$55.00	\$45.00
\$55.00	\$45.00
\$55.00	\$45.00
\$55.00	\$45.00
\$55.00	\$45.00



Replacement Cases

Main Cases		
Class 1, 2 and 3		
Nominal Value	Part #	Price
50 kg	Consult	Consult
25 kg	Consult	Consult
20 kg	80703	\$250.00
10 kg	80704	\$250.00
5 kg	80705	\$185.00
3 kg	190274	\$38.50
2 kg	190271	\$38.50
1 kg	190264	\$38.50
500 g	189715	\$38.50
300 g	196467	\$37.50

Main Cases		
Class 1, 2 and 3		
Nominal Value	Part #	Price
200 g	189637	\$38.50
100 g	189570	\$42.00
50 g	189509	\$42.00
30 g	189486	\$42.00
20 g	189484	\$42.00
10 g	189461	\$42.00
5 g	189349	\$42.00
3 g	194033	\$40.00
2 g	189237	\$42.00
1 g	198502	\$40.00

Accessories

Description	Part #	Price
Statement of Accuracy	36092	\$47.50
Serial number	25836	\$17.00
Tweezer	11711	\$5.00
Premium tweezer	152414	\$43.00
Weight glove, white cotton	11714	\$6.75
Leaf weight cover	11755	\$43.00
Lifter bar	11747	\$21.00
Lifter bar with larger handle	11712	\$73.00
Vial	50038	\$5.00

MASS REFERENCE STANDARDS / METRIC SINGLE WEIGHT WITH CASE (KITS)

RANGE: 50 kg – 1g

ASTM
PRECISION

OIML
PRECISION

BALANCE
CALIBRATION

STAINLESS
FIELD WEIGHTS

CAST IRON
FIELD WEIGHTS

ASTM
SPECIALTY

ACCESSORIES

Class 4

Nominal Value	Kit Part #	Price
50 kg	Consult	Consult
25 kg	Consult	Consult
20 kg	82716	\$2,450.00
10 kg	82717	\$1,780.00
5 kg	82718	\$1,230.00
3 kg	82719	\$890.00
2 kg	82720	\$725.00
1 kg	82721	\$480.00
500 g	82722	\$230.00
300 g	82723	\$165.00
200 g	82724	\$140.00
100 g	82725	\$100.00
50 g	82726	\$100.00
30 g	82727	\$85.00
20 g	82728	\$85.00
10 g	82729	\$79.00
5 g	82730	\$62.00
3 g	82731	\$62.00
2 g	82732	\$62.00
1g	82733	\$62.00

Optional Certificate

Accredited
Consult
Consult
\$75.00
\$75.00
\$75.00
\$75.00
\$75.00
\$55.00
\$55.00
\$55.00
\$40.00
\$40.00
\$40.00
\$40.00
\$40.00
\$40.00
\$40.00
\$40.00
\$40.00
\$40.00



Kits include a Single Weight with Case and Glove

Replacement Cases

Main Cases		
Class 4		
Nominal Value	Part #	Price
50 kg	Consult	Consult
25 kg	Consult	Consult
20 kg	80703	\$250.00
10 kg	80704	\$250.00
5 kg	80705	\$185.00
3 kg	190274	\$38.50
2 kg	190271	\$38.50
1 kg	190264	\$38.50
500 g	189715	\$38.50
300 g	196467	\$37.50
200 g	189637	\$38.50

Main Cases		
Class 4		
Nominal Value	Part #	Price
100 g	189570	\$42.00
50 g	189509	\$42.00
30 g	189486	\$42.00
20 g	189484	\$42.00
10 g	189461	\$42.00
5 g	189349	\$42.00
3 g	194033	\$40.00
2 g	189237	\$42.00
1g	198502	\$40.00

Accessories

Description	Part #	Price
Statement of Accuracy	36092	\$47.50
Serial number	25836	\$17.00
Tweezer	11711	\$5.00
Premium tweezer	152414	\$43.00
Weight glove, white cotton	11714	\$6.75
Leaf weight cover	11755	\$43.00
Lifter bar	11747	\$21.00
Lifter bar with larger handle	11712	\$73.00
Vial	50038	\$5.00

MASS REFERENCE STANDARDS / METRIC SINGLE WEIGHTS

RANGE: 50 kg – 1g

Class 1			Optional Certificate		Class 3			Optional Certificate	
Nominal Value	Part #	Price	Accredited	Non-Accredited	Nominal Value	Part #	Price	Accredited	Non-Accredited
50 kg	Consult	Consult	Consult	Consult	50 kg	12274	\$5,400.00	Consult	Consult
25 kg	11876	\$4,675.00	\$145.00	\$80.00	25 kg	12272	\$4,300.00	\$145.00	\$80.00
20 kg	11875	\$3,825.00	\$145.00	\$80.00	20 kg	12271	\$2,490.00	\$145.00	\$80.00
10 kg	11874	\$2,130.00	\$145.00	\$80.00	10 kg	12270	\$1,840.00	\$145.00	\$80.00
5 kg	11872	\$1,170.00	\$145.00	\$80.00	5 kg	12269	\$1,160.00	\$145.00	\$80.00
3 kg	11871	\$995.00	\$145.00	\$80.00	3 kg	12268	\$925.00	\$145.00	\$80.00
2 kg	11870	\$790.00	\$145.00	\$80.00	2 kg	12267	\$730.00	\$145.00	\$80.00
1 kg	11869	\$550.00	\$125.00	\$60.00	1 kg	12266	\$480.00	\$125.00	\$60.00
500 g	11867	\$230.00	\$125.00	\$60.00	500 g	12265	\$220.00	\$125.00	\$60.00
300 g	11866	\$175.00	\$125.00	\$60.00	300 g	12264	\$155.00	\$125.00	\$60.00
200 g	11865	\$160.00	\$125.00	\$60.00	200 g	12263	\$150.00	\$125.00	\$60.00
100 g	11864	\$120.00	\$55.00	\$45.00	100 g	12262	\$110.00	\$55.00	\$45.00
50 g	11862	\$115.00	\$55.00	\$45.00	50 g	12261	\$85.00	\$55.00	\$45.00
30 g	11861	\$105.00	\$55.00	\$45.00	30 g	12260	\$85.00	\$55.00	\$45.00
20 g	11860	\$105.00	\$55.00	\$45.00	20 g	12259	\$85.00	\$55.00	\$45.00
10 g	11859	\$100.00	\$55.00	\$45.00	10 g	12258	\$85.00	\$55.00	\$45.00
5 g	11857	\$93.00	\$55.00	\$45.00	5 g	12257	\$64.00	\$55.00	\$45.00
3 g	11856	\$79.00	\$55.00	\$45.00	3 g	12256	\$64.00	\$55.00	\$45.00
2 g	11855	\$79.00	\$55.00	\$45.00	2 g	12255	\$64.00	\$55.00	\$45.00
1 g	11854	\$73.00	\$55.00	\$45.00	1 g	12254	\$64.00	\$55.00	\$45.00

Class 2			Optional Certificate	
Nominal Value	Part #	Price	Accredited	Non-Accredited
50 kg	Consult	Consult	Consult	Consult
25 kg	12131	\$4,375.00	\$145.00	\$80.00
20 kg	12130	\$2,525.00	\$145.00	\$80.00
10 kg	12129	\$1,980.00	\$145.00	\$80.00
5 kg	12127	\$1,160.00	\$145.00	\$80.00
3 kg	12126	\$960.00	\$145.00	\$80.00
2 kg	12125	\$745.00	\$145.00	\$80.00
1 kg	12124	\$495.00	\$125.00	\$60.00
500 g	12122	\$225.00	\$125.00	\$60.00
300 g	12121	\$165.00	\$125.00	\$60.00
200 g	12120	\$155.00	\$125.00	\$60.00
100 g	12119	\$115.00	\$55.00	\$45.00
50 g	12117	\$93.00	\$55.00	\$45.00
30 g	12116	\$91.00	\$55.00	\$45.00
20 g	12115	\$91.00	\$55.00	\$45.00
10 g	12114	\$91.00	\$55.00	\$45.00
5 g	12112	\$68.00	\$55.00	\$45.00
3 g	12111	\$68.00	\$55.00	\$45.00
2 g	12110	\$68.00	\$55.00	\$45.00
1 g	12109	\$68.00	\$55.00	\$45.00

Replacement Cases

Main Cases		
Class 1, 2 and 3		
Nominal Value	Part #	Price
50 kg	Consult	Consult
25 kg	Consult	Consult
20 kg	80703	\$250.00
10 kg	80704	\$250.00
5 kg	80705	\$185.00
3 kg	190274	\$38.50
2 kg	190271	\$38.50
1 kg	190264	\$38.50
500 g	189715	\$38.50
300 g	196467	\$37.50

Main Cases		
Class 1, 2 and 3		
Nominal Value	Part #	Price
200 g	189637	\$38.50
100 g	189570	\$42.00
50 g	189509	\$42.00
30 g	189486	\$42.00
20 g	189484	\$42.00
10 g	189461	\$42.00
5 g	189349	\$42.00
3 g	194033	\$40.00
2 g	189237	\$38.00
1 g	198502	\$36.00

Accessories

Description	Part #	Price
Statement of Accuracy	36092	\$47.50
Serial number	25836	\$17.00
Tweezer	11711	\$5.00
Premium tweezer	152414	\$43.00
Weight glove, white cotton	11714	\$6.75
Leaf weight cover	11755	\$43.00
Lifter bar	11747	\$21.00
Lifter bar with larger handle	11712	\$73.00
Vial	50038	\$5.00

RANGE: 50 kg – 1g

Class 4

For special kits, single weights must ship in a case.

Nominal Value	Part #	Price
50 kg	Consult	Consult
25 kg	12375	\$4,225.00
20 kg	12374	\$2,330.00
10 kg	12373	\$1,640.00
5 kg	12372	\$1,100.00
3 kg	12371	\$860.00
2 kg	12370	\$700.00
1 kg	12369	\$455.00
500 g	12368	\$215.00
300 g	12367	\$150.00
200 g	12366	\$130.00
100 g	12365	\$93.00
50 g	12364	\$75.00
30 g	12363	\$68.00
20 g	12362	\$68.00
10 g	12361	\$68.00
5 g	12360	\$48.50
3 g	12359	\$48.50
2 g	12358	\$48.50
1 g	12357	\$48.50

Optional Certificate

Accredited
Consult
Consult
\$75.00
\$75.00
\$75.00
\$75.00
\$75.00
\$55.00
\$55.00
\$55.00
\$40.00
\$40.00
\$40.00
\$40.00
\$40.00
\$40.00
\$40.00
\$40.00
\$40.00
\$40.00
\$40.00



ASTM
PRECISION

OIML
PRECISION

BALANCE
CALIBRATION

STAINLESS
FIELD WEIGHTS

CAST IRON
FIELD WEIGHTS

ASTM
SPECIALTY

ACCESSORIES

Replacement Cases

Main Cases		
Class 4		
Nominal Value	Part #	Price
50 kg	Consult	Consult
25 kg	Consult	Consult
20 kg	80703	\$250.00
10 kg	80704	\$250.00
5 kg	80705	\$185.00
3 kg	190274	\$38.50
2 kg	190271	\$38.50
1 kg	190264	\$38.50
500 g	189715	\$38.50
300 g	196467	\$37.50

Main Cases		
Class 4		
Nominal Value	Part #	Price
200 g	189637	\$35.00
100 g	189570	\$38.00
50 g	189509	\$38.00
30 g	189486	\$38.00
20 g	189484	\$38.00
10 g	189461	\$38.00
5 g	189349	\$38.00
3 g	194033	\$36.00
2 g	189237	\$38.00
1 g	198502	\$36.00

Accessories

Description	Part #	Price
Statement of Accuracy	36092	\$47.50
Serial number	25836	\$17.00
Tweezer	11711	\$5.00
Premium tweezer	152414	\$43.00
Weight glove, white cotton	11714	\$6.75
Leaf weight cover	11755	\$43.00
Lifter bar	11747	\$21.00
Lifter bar with larger handle	11712	\$73.00
Vial	50038	\$5.00

MASS REFERENCE STANDARDS / METRIC SINGLE WEIGHT WITH CASE (KITS)

RANGE: 500 mg – 0.5 mg

Class 1

Enclosed in vial/case per requirements.

Nominal Value	Kit Part #	Price
500 mg	80458	\$73.00
300 mg	80459	\$73.00
200 mg	80460	\$73.00
100 mg	80461	\$73.00
50 mg	80462	\$73.00
30 mg	80463	\$73.00
20 mg	80464	\$73.00
10 mg	80465	\$73.00
5 mg	80466	\$73.00
3 mg	80467	\$73.00
2 mg	80468	\$73.00
1 mg	80469	\$73.00
0.5 mg*	36076	\$73.00

Optional Certificate

Accredited	Non-Accredited
\$55.00	\$45.00
\$55.00	\$45.00
\$55.00	\$45.00
\$55.00	\$45.00
\$55.00	\$45.00
\$55.00	\$45.00
\$55.00	\$45.00
\$55.00	\$45.00
\$55.00	\$45.00
\$55.00	\$45.00
\$55.00	\$45.00
\$55.00	\$45.00
\$55.00	\$45.00

Class 3

Enclosed in vial/case per requirements.

Weight	Kit Part #	Price
500 mg	80482	\$43.00
300 mg	80483	\$43.00
200 mg	80484	\$43.00
100 mg	80485	\$43.00
50 mg	80486	\$43.00
30 mg	80487	\$43.00
20 mg	80488	\$43.00
10 mg	80489	\$43.00
5 mg	80490	\$43.00
3 mg	80491	\$43.00
2 mg	80492	\$43.00
1 mg	80493	\$43.00
0.5 mg*	36078	\$43.00

Optional Certificate

Accredited	Non-Accredited
\$55.00	\$45.00
\$55.00	\$45.00
\$55.00	\$45.00
\$55.00	\$45.00
\$55.00	\$45.00
\$55.00	\$45.00
\$55.00	\$45.00
\$55.00	\$45.00
\$55.00	\$45.00
\$55.00	\$45.00
\$55.00	\$45.00
\$55.00	\$45.00
\$55.00	\$45.00

Class 2

Enclosed in vial/case per requirements.

Nominal Value	Kit Part #	Price
500 mg	80470	\$48.50
300 mg	80471	\$48.50
200 mg	80472	\$48.50
100 mg	80473	\$48.50
50 mg	80474	\$48.50
30 mg	80475	\$48.50
20 mg	80476	\$48.50
10 mg	80477	\$47.50
5 mg	80478	\$48.50
3 mg	80479	\$48.50
2 mg	80480	\$48.50
1 mg	80481	\$48.50
0.5 mg*	36077	\$48.50

Optional Certificate

Accredited	Non-Accredited
\$55.00	\$45.00
\$55.00	\$45.00
\$55.00	\$45.00
\$55.00	\$45.00
\$55.00	\$45.00
\$55.00	\$45.00
\$55.00	\$45.00
\$55.00	\$45.00
\$55.00	\$45.00
\$55.00	\$45.00
\$55.00	\$45.00
\$55.00	\$45.00
\$55.00	\$45.00

Class 4

Single leaf weights must ship in a vial.

Nominal Value	Kit Part #	Price
500 mg	80494	\$37.50
300 mg	80495	\$37.50
200 mg	80496	\$37.50
100 mg	80497	\$37.50
50 mg	80498	\$37.50
30 mg	80499	\$37.50
20 mg	80500	\$37.50
10 mg	80501	\$37.50
5 mg	80502	\$37.50
3 mg	80503	\$37.50
2 mg	80504	\$37.50
1 mg	80505	\$37.50
0.5 mg*	36079	\$79.00

Optional Certificate

Accredited
\$40.00
\$40.00
\$40.00
\$40.00
\$40.00
\$40.00
\$40.00
\$40.00
\$40.00
\$40.00
\$40.00
\$40.00
\$40.00

*Wire weight

**Replacement Cases**

Main Cases		
Class 1, 2 and 3		
Nominal Value	Part #	Price
500 mg	Consult	Consult
300 mg	Consult	Consult
200 mg	Consult	Consult
100 mg	Consult	Consult
50 mg	Consult	Consult
30 mg	Consult	Consult
20 mg	Consult	Consult
10 mg	Consult	Consult

Main Cases		
Class 1, 2 and 3		
Nominal Value	Part #	Price
5 mg	Consult	Consult
3 mg	Consult	Consult
2 mg	Consult	Consult
1 mg	Consult	Consult
0.5 mg	Consult	Consult

Accessories

Description	Part #	Price
Statement of Accuracy	36092	\$47.50
Serial number	25836	\$17.00
Tweezer	11711	\$5.00
Premium tweezer	152414	\$43.00
Weight glove, white cotton	11714	\$6.75
Leaf weight cover	11755	\$43.00
Lifter bar	11747	\$21.00
Lifter bar with larger handle	11712	\$73.00
Vial	50038	\$5.00

RANGE: 500 mg – 1 mg

Class 1

Single leaf weights must ship in a vial.

Nominal Value	Part #	Price
500 mg	11852	\$68.00
300 mg	11851	\$68.00
200 mg	11850	\$68.00
100 mg	11849	\$68.00
50 mg	11847	\$68.00
30 mg	11846	\$68.00
20 mg	11845	\$68.00
10 mg	11844	\$68.00
5 mg	11842	\$68.00
3 mg	11841	\$68.00
2 mg	11840	\$68.00
1 mg	11839	\$68.00

Optional Certificate

Accredited	Non-Accredited
\$55.00	\$45.00
\$55.00	\$45.00
\$55.00	\$45.00
\$55.00	\$45.00
\$55.00	\$45.00
\$55.00	\$45.00
\$55.00	\$45.00
\$55.00	\$45.00
\$55.00	\$45.00
\$55.00	\$45.00
\$55.00	\$45.00
\$55.00	\$45.00

Class 3

Single leaf weights must ship in a vial.

Nominal Value	Part #	Price
500 mg	12253	\$40.00
300 mg	12252	\$40.00
200 mg	12251	\$40.00
100 mg	12250	\$40.00
50 mg	12248	\$40.00
30 mg	12247	\$40.00
20 mg	12246	\$40.00
10 mg	12245	\$40.00
5 mg	12244	\$40.00
3 mg	12243	\$40.00
2 mg	12242	\$40.00
1 mg	12241	\$40.00

Optional Certificate

Accredited	Non-Accredited
\$55.00	\$45.00
\$55.00	\$45.00
\$55.00	\$45.00
\$55.00	\$45.00
\$55.00	\$45.00
\$55.00	\$45.00
\$55.00	\$45.00
\$55.00	\$45.00
\$55.00	\$45.00
\$55.00	\$45.00
\$55.00	\$45.00
\$55.00	\$45.00

Class 2

Single leaf weights must ship in a vial.

Nominal Value	Part #	Price
500 mg	12107	\$43.00
300 mg	12106	\$43.00
200 mg	12105	\$43.00
100 mg	12104	\$43.00
50 mg	12102	\$43.00
30 mg	12101	\$43.00
20 mg	12100	\$43.00
10 mg	12099	\$43.00
5 mg	12097	\$43.00
3 mg	12096	\$43.00
2 mg	12095	\$43.00
1 mg	12094	\$43.00

Optional Certificate

Accredited	Non-Accredited
\$55.00	\$45.00
\$55.00	\$45.00
\$55.00	\$45.00
\$55.00	\$45.00
\$55.00	\$45.00
\$55.00	\$45.00
\$55.00	\$45.00
\$55.00	\$45.00
\$55.00	\$45.00
\$55.00	\$45.00
\$55.00	\$45.00
\$55.00	\$45.00

Class 4

For special kits, single weights must ship in a case. Single leaf weights must ship in a vial.

Nominal Value	Part #	Price
500 mg	12356	\$37.50
300 mg	12355	\$37.50
200 mg	12354	\$37.50
100 mg	12353	\$37.50
50 mg	12352	\$37.50
30 mg	12351	\$37.50
20 mg	12350	\$37.50
10 mg	22198	\$37.50
5 mg	22197	\$37.50
3 mg	22196	\$37.50
2 mg	22195	\$37.50
1 mg	22194	\$37.50

Optional Certificate

Accredited
\$40.00
\$40.00
\$40.00
\$40.00
\$40.00
\$40.00
\$40.00
\$40.00
\$40.00
\$40.00
\$40.00
\$40.00



Leaf (Milligram) Weight

Replacement Cases

Main Cases		
Class 1, 2 and 3		
Nominal Value	Part #	Price
500 mg	Consult	Consult
300 mg	Consult	Consult
200 mg	Consult	Consult
100 mg	Consult	Consult
50 mg	Consult	Consult
30 mg	Consult	Consult

Main Cases		
Class 1, 2 and 3		
Nominal Value	Part #	Price
20 mg	Consult	Consult
10 mg	Consult	Consult
5 mg	Consult	Consult
3 mg	Consult	Consult
2 mg	Consult	Consult
1 mg	Consult	Consult

Accessories

Description	Part #	Price
Statement of Accuracy	36092	\$47.50
Serial number	25836	\$17.00
Tweezer	11711	\$5.00
Premium tweezer	152414	\$43.00
Weight glove, white cotton	11714	\$6.75
Leaf weight cover	11755	\$43.00
Lifter bar	11747	\$21.00
Lifter bar with larger handle	11712	\$73.00
Vial	50038	\$5.00

MASS REFERENCE STANDARDS / AVOIRDUPOIS SINGLE WEIGHT WITH CASE (KITS)

RANGE: 30 lb – 1/16 oz

Class 1			Optional Certificate		Class 2			Optional Certificate	
Nominal Value	Kit Part #	Price	Accredited	Non-Accredited	Nominal Value	Kit Part #	Price	Accredited	Non-Accredited
30 lb	82581	\$4,125.00	\$130.00	\$85.00	30 lb	82625	\$4,025.00	\$130.00	\$85.00
25 lb	82580	\$2,850.00	\$130.00	\$85.00	25 lb	82624	\$3,425.00	\$130.00	\$85.00
20 lb	82579	\$2,825.00	\$130.00	\$85.00	20 lb	82623	\$2,750.00	\$130.00	\$85.00
10 lb	82578	\$1,660.00	\$130.00	\$85.00	10 lb	82622	\$1,620.00	\$130.00	\$85.00
5 lb	82589	\$1,200.00	\$130.00	\$85.00	5 lb	82631	\$1,150.00	\$130.00	\$85.00
4 lb	82588	\$1,010.00	\$130.00	\$85.00	4 lb	82630	\$965.00	\$130.00	\$85.00
3 lb	82587	\$765.00	\$130.00	\$85.00	3 lb	82629	\$700.00	\$130.00	\$85.00
2 lb	82586	\$670.00	\$105.00	\$70.00	2 lb	82628	\$630.00	\$105.00	\$70.00
1 lb	82585	\$340.00	\$105.00	\$70.00	1 lb	82627	\$320.00	\$105.00	\$70.00
8 oz	82584	\$280.00	\$55.00	\$45.00	8 oz	82626	\$265.00	\$55.00	\$45.00
0.5 lb	82570	\$285.00	\$55.00	\$45.00	0.5 lb	82614	\$265.00	\$55.00	\$45.00
0.3 lb	118809	\$215.00	\$55.00	\$45.00	0.3 lb	118810	\$205.00	\$55.00	\$45.00
0.2 lb	82569	\$185.00	\$55.00	\$45.00	0.2 lb	82613	\$185.00	\$55.00	\$45.00
0.1 lb	82568	\$135.00	\$55.00	\$45.00	0.1 lb	82612	\$125.00	\$55.00	\$45.00
0.05 lb	82567	\$125.00	\$55.00	\$45.00	0.05 lb	82611	\$120.00	\$55.00	\$45.00
0.03 lb	118805	\$120.00	\$55.00	\$45.00	0.03 lb	118806	\$110.00	\$55.00	\$45.00
0.02 lb	82566	\$120.00	\$55.00	\$45.00	0.02 lb	82610	\$115.00	\$55.00	\$45.00
0.01 lb	82565	\$120.00	\$55.00	\$45.00	0.01 lb	82609	\$110.00	\$55.00	\$45.00
0.005 lb	82564	\$120.00	\$55.00	\$45.00	0.005 lb	82608	\$110.00	\$55.00	\$45.00
0.003 lb	118801	\$120.00	\$55.00	\$45.00	0.003 lb	118802	\$110.00	\$55.00	\$45.00
4 oz	82577	\$155.00	\$55.00	\$45.00	4 oz	82621	\$155.00	\$55.00	\$45.00
2 oz	82576	\$135.00	\$55.00	\$45.00	2 oz	82620	\$125.00	\$55.00	\$45.00
1 oz	82575	\$115.00	\$55.00	\$45.00	1 oz	82619	\$115.00	\$55.00	\$45.00
1/2 oz	82574	\$110.00	\$55.00	\$45.00	1/2 oz	82618	\$105.00	\$55.00	\$45.00
1/4 oz	82573	\$110.00	\$55.00	\$45.00	1/4 oz	82617	\$105.00	\$55.00	\$45.00
1/8 oz	82572	\$110.00	\$55.00	\$45.00	1/8 oz	82616	\$105.00	\$55.00	\$45.00
1/16 oz	82571	\$110.00	\$55.00	\$45.00	1/16 oz	82615	\$105.00	\$55.00	\$45.00

Replacement Cases

Main Cases		
Class 1, 2 and 3 Screw Knob		
Nominal Value	Part #	Price
30 lb	80743	\$250.00
25 lb	80742	\$250.00
20 lb	80741	\$250.00
10 lb	80740	\$250.00
5 lb	190272	\$38.50
4 lb	190268	\$38.50
3 lb	190265	\$38.50
2 lb	190261	\$38.50
1 lb	189713	\$38.50
8 oz	189638	\$38.50
0.5 lb	189638	\$38.50
0.3 lb	189633	\$38.50
0.2 lb	189569	\$42.00
0.1 lb	189508	\$42.00

Main Cases		
Class 1, 2 and 3 Screw Knob		
Nominal Value	Part #	Price
0.05 lb	189485	\$42.00
0.03 lb	189478	\$42.00
0.02 lb	189460	\$42.00
0.01 lb	189349	\$42.00
0.005 lb	189239	\$42.00
0.003 lb	189234	\$42.00
4 oz	189571	\$42.00
2 oz	190126	\$38.50
1 oz	189486	\$42.00
1/2 oz	189478	\$42.00
1/4 oz	189350	\$42.00
1/8 oz	194034	\$40.00
1/16 oz	189237	\$42.00

Main Cases		
Class 4 Screw Knob		
Nominal Value	Part #	Price
30 lb	80743	\$250.00
25 lb	80742	\$250.00
20 lb	80741	\$250.00
10 lb	80740	\$250.00
5 lb	190272	\$38.50
4 lb	190268	\$38.50
3 lb	190265	\$38.50
2 lb	190261	\$38.50
1 lb	189713	\$38.50
8 oz	189638	\$38.50
0.5 lb	189638	\$38.50
0.3 lb	189633	\$38.50
0.2 lb	189569	\$42.00
0.1 lb	189508	\$42.00

MASS REFERENCE STANDARDS / AVOIRDUPOIS SINGLE WEIGHT WITH CASE (KITS)

RANGE: 30 lb – 1/16 oz

Class 3			Optional Certificate		Class 4			Optional Certificate	
Nominal Value	Kit Part #	Price	Accredited	Non-Accredited	Nominal Value	Kit Part #	Price	Accredited	
30 lb	82667	\$3,875.00	\$130.00	\$85.00	30 lb	82709	\$3,825.00	\$80.00	
25 lb	82666	\$3,275.00	\$130.00	\$85.00	25 lb	82708	\$3,250.00	\$80.00	
20 lb	82665	\$2,600.00	\$130.00	\$85.00	20 lb	82707	\$2,575.00	\$80.00	
10 lb	82664	\$1,510.00	\$130.00	\$85.00	10 lb	82706	\$1,500.00	\$80.00	
5 lb	82673	\$1,120.00	\$130.00	\$85.00	5 lb	82715	\$1,110.00	\$80.00	
4 lb	82672	\$930.00	\$130.00	\$85.00	4 lb	82714	\$845.00	\$80.00	
3 lb	82671	\$675.00	\$130.00	\$85.00	3 lb	82713	\$650.00	\$80.00	
2 lb	82670	\$610.00	\$105.00	\$70.00	2 lb	82712	\$590.00	\$65.00	
1 lb	82669	\$305.00	\$105.00	\$70.00	1 lb	82711	\$280.00	\$65.00	
8 oz	82668	\$265.00	\$55.00	\$45.00	8 oz	82710	\$255.00	\$40.00	
0.5 lb	82656	\$265.00	\$55.00	\$45.00	0.5 lb	82698	\$265.00	\$40.00	
0.3 lb	118811	\$170.00	\$55.00	\$45.00	0.3 lb	118812	\$185.00	\$40.00	
0.2 lb	82655	\$140.00	\$55.00	\$45.00	0.2 lb	82697	\$135.00	\$40.00	
0.1 lb	82654	\$125.00	\$55.00	\$45.00	0.1 lb	82696	\$115.00	\$40.00	
0.05 lb	82653	\$115.00	\$55.00	\$45.00	0.05 lb	82695	\$110.00	\$40.00	
0.03 lb	118807	\$110.00	\$55.00	\$45.00	0.03 lb	118808	\$93.00	\$40.00	
0.02 lb	82652	\$110.00	\$55.00	\$45.00	0.02 lb	82694	\$110.00	\$40.00	
0.01 lb	82651	\$110.00	\$55.00	\$45.00	0.01 lb	82693	\$110.00	\$40.00	
0.005 lb	82650	\$105.00	\$55.00	\$45.00	0.005 lb	82692	\$110.00	\$40.00	
0.003 lb	118803	\$105.00	\$55.00	\$45.00	0.003 lb	118804	\$110.00	\$40.00	
4 oz	82663	\$150.00	\$55.00	\$45.00	4 oz	82705	\$135.00	\$40.00	
2 oz	82662	\$125.00	\$55.00	\$45.00	2 oz	82704	\$125.00	\$40.00	
1 oz	82661	\$105.00	\$55.00	\$45.00	1 oz	82703	\$115.00	\$40.00	
1/2 oz	82660	\$105.00	\$55.00	\$45.00	1/2 oz	82702	\$110.00	\$40.00	
1/4 oz	82659	\$105.00	\$55.00	\$45.00	1/4 oz	82701	\$110.00	\$40.00	
1/8 oz	82658	\$105.00	\$55.00	\$45.00	1/8 oz	82700	\$110.00	\$40.00	
1/16 oz	82657	\$105.00	\$55.00	\$45.00	1/16 oz	82699	\$110.00	\$40.00	

ASTM PRECISION
OIML PRECISION
BALANCE CALIBRATION
STAINLESS FIELD WEIGHTS
CAST IRON FIELD WEIGHTS
ASTM SPECIALTY
ACCESSORIES



Kits include a single weight with case and glove

Accessories

Main Cases		
Class 4 Screw Knob		
Nominal Value	Part #	Price
0.05 lb	189485	\$42.00
0.03 lb	189478	\$42.00
0.02 lb	189460	\$42.00
0.01 lb	189349	\$42.00
0.005 lb	189239	\$42.00
0.003 lb	189234	\$42.00
4 oz	189571	\$42.00
2 oz	190126	\$38.50
1 oz	189486	\$42.00
1/2 oz	189478	\$42.00
1/4 oz	189350	\$42.00
1/8 oz	194034	\$40.00
1/16 oz	189237	\$42.00

Description	Part #	Price
Statement of Accuracy	36092	\$47.50
Weight glove, white cotton	11714	\$6.75
Tweezer	11711	\$5.00
Premium tweezer	152414	\$43.00
Serial number	25836	\$17.00
Vial	50038	\$5.00
Lifter bar	11747	\$21.00
Capsule	80420	\$5.00

MASS REFERENCE STANDARDS / AVOIRDUPOIS SINGLE WEIGHT WITH CASE (KITS)

RANGE: 0.001lb – 1/32 oz

Class 1

Enclosed in vial/case per requirements.

Optional Certificate

Nominal Value	Part #	Price	Optional Certificate	
			Accredited	Non-Accredited
0.001lb	80428	\$110.00	\$55.00	\$45.00
0.002lb	80439	\$110.00	\$55.00	\$45.00
1/32 oz	80442	\$110.00	\$55.00	\$45.00

Class 2

Enclosed in vial/case per requirements.

Optional Certificate

Nominal Value	Part #	Price	Optional Certificate	
			Accredited	Non-Accredited
0.001lb	80443	\$110.00	\$55.00	\$45.00
0.002lb	80445	\$105.00	\$55.00	\$45.00
1/32 oz	80446	\$105.00	\$55.00	\$45.00

Class 3

Enclosed in vial/case per requirements.

Optional Certificate

Nominal Value	Part #	Price	Optional Certificate	
			Accredited	Non-Accredited
0.001lb	80448	\$105.00	\$55.00	\$45.00
0.002lb	80449	\$105.00	\$55.00	\$45.00
1/32 oz	80451	\$105.00	\$55.00	\$45.00

**Replacement Cases**

Main Case		
Class 1, 2 and 3 Leaf		
Nominal Value	Part #	Price
0.001lb	Consult	Consult
0.002lb	Consult	Consult
1/32 oz	Consult	Consult

Accessories

Description	Part #	Price
Statement of Accuracy	36092	\$47.50
Weight glove, white cotton	11714	\$6.75
Tweezer	11711	\$5.00
Premium tweezer	152414	\$43.00
Serial number	25836	\$17.00
Vial	50038	\$5.00
Lifter bar	11747	\$21.00

MASS REFERENCE STANDARDS / AVOIRDUPOIS SINGLE WEIGHTS

RANGE: 50 lb – 1/16 oz

Class 1			Optional Certificate		Class 2			Optional Certificate	
Nominal Value	Part #	Price	Accredited	Non-Accredited	Weight	Part #	Price	Accredited	Non-Accredited
50 lb	12056	\$5,400.00	\$285.00	\$85.00	50 lb	12202	\$5,325.00	\$285.00	\$85.00
30 lb	12055	\$3,975.00	\$130.00	\$85.00	30 lb	12201	\$3,875.00	\$130.00	\$85.00
25 lb	12054	\$3,350.00	\$130.00	\$85.00	25 lb	12200	\$3,275.00	\$130.00	\$85.00
20 lb	12053	\$2,700.00	\$130.00	\$85.00	20 lb	12199	\$2,625.00	\$130.00	\$85.00
10 lb	12052	\$1,530.00	\$130.00	\$85.00	10 lb	12198	\$1,480.00	\$130.00	\$85.00
5 lb	12050	\$1,140.00	\$130.00	\$85.00	5 lb	12196	\$1,100.00	\$130.00	\$85.00
4 lb	12049	\$960.00	\$130.00	\$85.00	4 lb	12195	\$890.00	\$130.00	\$85.00
3 lb	12048	\$735.00	\$130.00	\$85.00	3 lb	12194	\$660.00	\$130.00	\$85.00
2 lb	12047	\$635.00	\$105.00	\$70.00	2 lb	12193	\$605.00	\$105.00	\$70.00
1 lb	12046	\$305.00	\$105.00	\$70.00	1 lb	12192	\$305.00	\$105.00	\$70.00
8 oz	12044	\$280.00	\$55.00	\$45.00	8 oz	12190	\$260.00	\$55.00	\$45.00
0.5 lb	12034	\$275.00	\$55.00	\$45.00	0.5 lb	12180	\$260.00	\$55.00	\$45.00
0.3 lb	118518	\$215.00	\$55.00	\$45.00	0.3 lb	118519	\$205.00	\$55.00	\$45.00
0.2 lb	12033	\$170.00	\$55.00	\$45.00	0.2 lb	12179	\$170.00	\$55.00	\$45.00
0.1 lb	12032	\$125.00	\$55.00	\$45.00	0.1 lb	12178	\$120.00	\$55.00	\$45.00
0.05 lb	12027	\$115.00	\$55.00	\$45.00	0.05 lb	12173	\$115.00	\$55.00	\$45.00
0.03 lb	118514	\$110.00	\$55.00	\$45.00	0.03 lb	118515	\$110.00	\$55.00	\$45.00
0.02 lb	12022	\$110.00	\$55.00	\$45.00	0.02 lb	12168	\$110.00	\$55.00	\$45.00
0.01 lb	12020	\$110.00	\$55.00	\$45.00	0.01 lb	12166	\$110.00	\$55.00	\$45.00
0.005 lb	12013	\$110.00	\$55.00	\$45.00	0.005 lb	12159	\$110.00	\$55.00	\$45.00
0.003 lb	118510	\$110.00	\$55.00	\$45.00	0.003 lb	118511	\$110.00	\$55.00	\$45.00
4 oz	12043	\$140.00	\$55.00	\$45.00	4 oz	12189	\$140.00	\$55.00	\$45.00
2 oz	12042	\$125.00	\$55.00	\$45.00	2 oz	12188	\$120.00	\$55.00	\$45.00
1 oz	12041	\$100.00	\$55.00	\$45.00	1 oz	12187	\$100.00	\$55.00	\$45.00
1/2 oz	12040	\$110.00	\$55.00	\$45.00	1/2 oz	12186	\$110.00	\$55.00	\$45.00
1/4 oz	12039	\$110.00	\$55.00	\$45.00	1/4 oz	12185	\$110.00	\$55.00	\$45.00
1/8 oz	12038	\$110.00	\$55.00	\$45.00	1/8 oz	12184	\$110.00	\$55.00	\$45.00
1/16 oz	12037	\$110.00	\$55.00	\$45.00	1/16 oz	12183	\$110.00	\$55.00	\$45.00

Replacement Cases

Main Cases		
Class 1, 2 and 3 Screw Knob		
Nominal Value	Part #	Price
50 lb	Consult	Consult
30 lb	80743	\$250.00
25 lb	80742	\$250.00
20 lb	80741	\$250.00
10 lb	80740	\$250.00
5 lb	190272	\$38.50
4 lb	190268	\$38.50
3 lb	190265	\$38.50
2 lb	190261	\$38.50
1 lb	189713	\$38.50

Main Cases		
Class 1, 2 and 3 Screw Knob		
Nominal Value	Part #	Price
8 oz	189638	\$38.50
0.5 lb	189638	\$38.50
0.3 lb	189633	\$38.50
0.2 lb	189569	\$42.00
0.1 lb	189508	\$42.00
0.05 lb	189485	\$42.00
0.03 lb	189478	\$42.00
0.02 lb	189460	\$42.00
0.01 lb	189349	\$42.00
0.005 lb	189239	\$42.00

Main Cases		
Class 1, 2 and 3 Screw Knob		
Nominal Value	Part #	Price
0.003 lb	189234	\$42.00
4 oz	189571	\$42.00
2 oz	190126	\$38.50
1 oz	189486	\$42.00
1/2 oz	189478	\$42.00
1/4 oz	189350	\$42.00
1/8 oz	194034	\$40.00
1/16 oz	189237	\$42.00

RANGE: 50 lb – 1/16 oz

ASTM
PRECISION

OIML
PRECISION

BALANCE
CALIBRATION

STAINLESS
FIELD WEIGHTS

CAST IRON
FIELD WEIGHTS

ASTM
SPECIALTY

ACCESSORIES

Class 3

Nominal Value	Part #	Price
50 lb	12335	\$5,250.00
30 lb	12334	\$3,725.00
25 lb	12333	\$3,150.00
20 lb	12332	\$2,440.00
10 lb	12331	\$1,410.00
5 lb	12330	\$1,070.00
4 lb	12329	\$880.00
3 lb	12328	\$635.00
2 lb	12327	\$580.00
1 lb	12326	\$290.00
8 oz	12325	\$250.00
0.5 lb	12316	\$229.00
0.3 lb	118520	\$170.00
0.2 lb	12315	\$130.00
0.1 lb	12314	\$115.00
0.05 lb	12310	\$110.00
0.03 lb	118516	\$110.00
0.02 lb	22185	\$110.00
0.01 lb	22183	\$110.00
0.005 lb	12297	\$110.00
0.003 lb	118512	\$110.00
4 oz	12324	\$140.00
2 oz	12323	\$120.00
1 oz	12322	\$93.00
1/2 oz	12321	\$110.00
1/4 oz	12320	\$110.00
1/8 oz	12319	\$110.00
1/16 oz	12318	\$110.00

Optional Certificate

Accredited	Non-Accredited
\$285.00	\$85.00
\$130.00	\$85.00
\$130.00	\$85.00
\$130.00	\$85.00
\$130.00	\$85.00
\$130.00	\$85.00
\$130.00	\$85.00
\$130.00	\$85.00
\$130.00	\$85.00
\$105.00	\$70.00
\$105.00	\$70.00
\$55.00	\$45.00
\$55.00	\$45.00
\$55.00	\$45.00
\$55.00	\$45.00
\$55.00	\$45.00
\$55.00	\$45.00
\$55.00	\$45.00
\$55.00	\$45.00
\$55.00	\$45.00
\$55.00	\$45.00
\$55.00	\$45.00
\$55.00	\$45.00
\$55.00	\$45.00
\$55.00	\$45.00
\$55.00	\$45.00
\$55.00	\$45.00
\$55.00	\$45.00
\$55.00	\$45.00
\$55.00	\$45.00
\$55.00	\$45.00
\$55.00	\$45.00
\$55.00	\$45.00

Class 4

Nominal Value	Part #	Price
50 lb	12438	\$5,175.00
30 lb	12437	\$3,700.00
25 lb	12436	\$3,100.00
20 lb	12435	\$2,410.00
10 lb	12434	\$1,360.00
5 lb	12433	\$1,040.00
4 lb	12432	\$810.00
3 lb	12431	\$615.00
2 lb	12430	\$570.00
1 lb	12429	\$265.00
8 oz	12428	\$245.00
0.5 lb	12419	\$255.00
0.3 lb	118521	\$160.00
0.2 lb	12418	\$125.00
0.1 lb	12417	\$100.00
0.05 lb	12413	\$110.00
0.03 lb	118517	\$110.00
0.02 lb	12408	\$110.00
0.01 lb	12406	\$100.00
0.005 lb	12400	\$100.00
0.003 lb	118513	\$100.00
4 oz	12427	\$120.00
2 oz	12426	\$115.00
1 oz	12425	\$100.00
1/2 oz	12424	\$110.00
1/4 oz	12423	\$110.00
1/8 oz	12422	\$110.00
1/16 oz	12421	\$110.00

Optional Certificate

Accredited
\$80.00
\$80.00
\$80.00
\$80.00
\$80.00
\$80.00
\$80.00
\$80.00
\$80.00
\$65.00
\$65.00
\$40.00
\$40.00
\$40.00
\$40.00
\$40.00
\$40.00
\$40.00
\$40.00
\$40.00
\$40.00
\$40.00
\$40.00
\$40.00
\$40.00
\$40.00
\$40.00
\$40.00
\$40.00
\$40.00
\$40.00
\$40.00
\$40.00
\$40.00
\$40.00



Replacement Cases

Main Cases		
Class 4 Screw Knob		
Nominal Value	Part #	Price
50 lb	Consult	Consult
30 lb	80743	\$250.00
25 lb	80742	\$250.00
20 lb	80741	\$250.00
10 lb	80740	\$250.00
5 lb	190272	\$38.50
4 lb	190268	\$38.50
3 lb	190265	\$38.50
2 lb	190261	\$38.50
1 lb	189713	\$38.50

Main Cases		
Class 4 Screw Knob		
Nominal Value	Part #	Price
8 oz	189638	\$38.50
0.5 lb	189638	\$38.50
0.3 lb	189633	\$38.50
0.2 lb	189569	\$42.00
0.1 lb	189508	\$42.00
0.05 lb	189485	\$42.00
0.03 lb	189478	\$42.00
0.02 lb	189460	\$42.00
0.01 lb	189349	\$42.00
0.005 lb	189239	\$42.00

Main Cases		
Class 4 Screw Knob		
Nominal Value	Part #	Price
0.003 lb	189234	\$42.00
4 oz	189571	\$42.00
2 oz	190126	\$38.50
1 oz	189486	\$42.00
1/2 oz	189478	\$42.00
1/4 oz	189350	\$42.00
1/8 oz	194034	\$40.00
1/16 oz	189237	\$42.00

MASS REFERENCE STANDARDS / AVOIRDUPOIS SINGLE WEIGHTS

RANGE: 0.001lb – 1/32 oz

Class 1

Single leaf weights must ship in a vial.

Nominal Value	Part #	Price
0.001lb	12007	\$110.00
0.002lb	12009	\$110.00
1/32 oz	12036	\$110.00

Optional Certificate

Accredited	Non-Accredited
\$55.00	\$45.00
\$55.00	\$45.00
\$55.00	\$45.00

Class 2

Single leaf weights must ship in a vial.

Nominal Value	Part #	Price
0.001lb	12153	\$110.00
0.002lb	12155	\$110.00
1/32 oz	12182	\$110.00

Optional Certificate

Accredited	Non-Accredited
\$55.00	\$45.00
\$55.00	\$45.00
\$55.00	\$45.00

Class 3

Single leaf weights must ship in a vial.

Nominal Value	Part #	Price
0.001lb	12291	\$110.00
0.002lb	12293	\$110.00
1/32 oz	12317	\$110.00

Optional Certificate

Accredited	Non-Accredited
\$55.00	\$45.00
\$55.00	\$45.00
\$55.00	\$45.00

Class 4

For special kits-single weights must ship in a vial.

Nominal Value	Part #	Price
0.001lb	12394	\$93.00
0.002lb	12396	\$93.00
1/32 oz	12420	\$93.00

Optional Certificate

Accredited
\$40.00
\$40.00
\$40.00

**Replacement Cases**

Main Case		
Class 1, 2 and 3 Leaf		
Nominal Value	Part #	Price
0.001lb	Consult	Consult
0.002lb	Consult	Consult
1/32 oz	Consult	Consult

Main Case		
Class 4 Leaf		
Nominal Value	Part #	Price
0.001lb	Consult	Consult
0.002lb	Consult	Consult
1/32 oz	Consult	Consult

Accessories

Description	Part #	Price
Statement of Accuracy	36092	\$47.50
Weight glove, white cotton	11714	\$6.75
Tweezer	11711	\$5.00
Premium tweezer	152414	\$43.00
Serial number	25836	\$17.00
Vial	50038	\$5.00
Lifter bar	11747	\$21.00

MASS REFERENCE STANDARDS ESSENTIAL WEIGHTS

Class 0

Set Range	Part #	Price
2 g, 200 mg, 1 mg	186177	\$370.00
5 g, 500 mg, 1 mg	186178	\$400.00

Class 1

Set Range	Part #	Price
20 g, 2 g, 20 mg	186179	\$340.00
100 g, 10 g, 20 mg	186180	\$415.00
100 g, 10 g, 200 mg	186181	\$415.00
200 g, 20 g, 20 mg	186182	\$435.00
200 g, 20 g, 200 mg	186183	\$435.00
200 g, 20 g, 2 g	186184	\$455.00
500 g, 50 g, 200 mg	186185	\$580.00
500 g, 50 g, 2 g	186186	\$600.00
1 kg, 100 g, 2 g	186187	\$770.00
1 kg, 100 g, 20 g	186188	\$790.00
2 kg, 200 g, 2 g	186189	\$1,120.00
2 kg, 200 g, 20 g	186190	\$1,140.00
5 kg, 500 g, 2 g	186191	\$1,410.00
5 kg, 500 g, 20 g	186192	\$1,440.00
100 g, 10 g, 2 g	191089	\$455.00
500 g, 50 g, 20 mg	191091	\$655.00
50 g, 5 g, 200 mg	191092	\$445.00
50 g, 5 g, 2 g	191093	\$445.00

Standard Features

- Polished stainless steel Type II design
- Sealing cavity
- Density is approximately 7.95 g/cm³
- Special PVC weight case
- Precision tweezers included
- Configurations are ideal for calibration, shift tests and sensitivity tests
- Other configurations available by special order
- Meets USP-41 requirements for intermediate checks
- Includes ISO 17025 Accredited Certificate of Calibration



200g PVC Set Shown, Other Sets Will Vary

Accessories

Description	Part #	Price
Weight glove, white cotton	11714	\$6.75
Tweezer	11711	\$5.00
Premium tweezer	152414	\$43.00
Lifter bar	11747	\$21.00

ASTM
PRECISION

OIML
PRECISION

BALANCE
CALIBRATION

STAINLESS
FIELD WEIGHTS

CAST IRON
FIELD WEIGHTS

ASTM
SPECIALTY

ACCESSORIES

MASS REFERENCE STANDARDS / METRIC SETS

RANGE: 500 mg

Class 0

Statement of Accuracy not available.

Certificate

Set Range	Part #	Price	Accredited
500 mg - 1 mg	45933	\$2,140.00	Included
500 mg - 1 mg*	96359	\$2,140.00	Included
500 mg - 10 mg	84141	\$1,580.00	Included
500 mg - 10 mg*	98191	\$1,580.00	Included
500 mg - 100 mg	45934	\$1,100.00	Included
500 mg - 100 mg*	96360	\$1,100.00	Included

Class 1

Optional Certificate

Set Range	Part #	Price	Accredited	Non-accredited
500 mg - 1 mg	12445	\$660.00	\$470.00	\$375.00
500 mg - 1 mg*	11910	\$660.00	\$470.00	\$375.00
500 mg - 10 mg	12447	\$490.00	\$310.00	\$250.00
500 mg - 10 mg*	11909	\$490.00	\$310.00	\$250.00
500 mg - 100 mg	45952	\$455.00	\$155.00	\$125.00
500 mg - 100 mg*	45944	\$470.00	\$155.00	\$125.00

Class 2

Optional Certificate

Set Range	Part #	Price	Accredited	Non-accredited
500 mg - 1 mg	11838	\$570.00	\$470.00	\$375.00
500 mg - 1 mg*	12176	\$570.00	\$470.00	\$375.00
500 mg - 10 mg	11848	\$455.00	\$310.00	\$250.00
500 mg - 10 mg*	12175	\$455.00	\$310.00	\$250.00
500 mg - 100 mg	45953	\$400.00	\$155.00	\$125.00
500 mg - 100 mg*	45945	\$400.00	\$155.00	\$125.00

Class 3

Optional Certificate

Set Range	Part #	Price	Accredited	Non-accredited
500 mg - 1 mg	11946	\$550.00	\$470.00	\$375.00
500 mg - 1 mg*	12313	\$550.00	\$470.00	\$375.00
500 mg - 10 mg	11956	\$400.00	\$310.00	\$250.00
500 mg - 10 mg*	12312	\$400.00	\$310.00	\$250.00
500 mg - 100 mg	45954	\$320.00	\$155.00	\$125.00
500 mg - 100 mg*	45946	\$320.00	\$155.00	\$125.00

Class 4

Optional Certificate

Set Range	Part #	Price	Accredited
500 mg - 1 mg	12093	\$345.00	\$280.00
500 mg - 1 mg*	12416	\$345.00	\$280.00
500 mg - 10 mg	12103	\$260.00	\$190.00
500 mg - 10 mg*	12415	\$260.00	\$190.00
500 mg - 100 mg	45955	\$205.00	\$95.00
500 mg - 100 mg*	45947	\$205.00	\$95.00

* 5-2-2-1 configuration

Replacement Cases

Main Cases		
Class 0		
Set Range	Part #	Price
500 mg - 1 mg	34699	\$125.00
500 mg - 1 mg	34699	\$125.00
500 mg - 10 mg	34699	\$125.00
500 mg - 10 mg	34699	\$125.00
500 mg - 100 mg	34699	\$125.00
500 mg - 100 mg	34699	\$125.00

Main Case		
Class 1, 2 and 3 (Includes leaf weight lid and slot for tweezer)		
Set Range	Part #	Price
500 mg - 1 mg	11763	\$85.00
500 mg - 1 mg	11763	\$85.00
500 mg - 10 mg	11763	\$85.00
500 mg - 10 mg	11763	\$85.00
500 mg - 100 mg	11763	\$85.00
500 mg - 100 mg	11763	\$85.00

Main Cases		
Class 4		
Set Range	Part #	Price
500 mg - 1 mg	11763	\$85.00
500 mg - 1 mg	11763	\$85.00
500 mg - 10 mg	11763	\$85.00
500 mg - 10 mg	11763	\$85.00
500 mg - 100 mg	11763	\$85.00
500 mg - 100 mg	11763	\$85.00

RANGE: 500 mg

Weight Set Contents

5-2-2-1		5-2-2-1		5-2-2-1	
500 mg - 1 mg	500 mg - 1 mg	500 mg - 10 mg	500 mg - 10 mg	500 mg - 100 mg	500 mg - 100 mg
45933 Class 0	96359 Class 0	84141 Class 0	98191 Class 0	45934 Class 0	96360 Class 0
12445 Class 1	11910 Class 1	12447 Class 1	11909 Class 1	45952 Class 1	45944 Class 1
11838 Class 2	12176 Class 2	11848 Class 2	12175 Class 2	45953 Class 2	45945 Class 2
11946 Class 3	12313 Class 3	11956 Class 3	12312 Class 3	45954 Class 3	45946 Class 3
12093 Class 4	12416 Class 4	12103 Class 4	12415 Class 4	45955 Class 4	45947 Class 4
(1) 500 mg	(1) 500 mg	(1) 500 mg	(1) 500 mg	(1) 500 mg	(1) 500 mg
(1) 300 mg	–	(1) 300 mg	–	(1) 300 mg	–
(1) 200 mg	(2) 200 mg	(1) 200 mg	(2) 200 mg	(1) 200 mg	(2) 200 mg
(1) 100 mg	(1)	(1) 100 mg	(1) 100 mg	(1) 100 mg	(1) 100 mg
(1) 50 mg	(1) 50 mg	(1) 50 mg	(1) 50 mg		
(1) 30 mg	–	(1) 30 mg	–		
(1) 20 mg	(2) 20 mg	(1) 20 mg	(2) 20 mg		
(1) 10 mg	(1) 10 mg	(1) 10 mg	(1) 10 mg		
(1) 5 mg	(1) 5 mg				
(1) 3 mg	(2) 2 mg				
(1) 2 mg	–				
(1) 1 mg	(1) 1 mg				
12 pcs. 1.221g set wt.	12 pcs. 1.11g set wt.	8 pcs. 1.21g set wt.	8 pcs. 1.11g set wt.	4 pcs. 1.1g set wt.	4 pcs. 0.8g set wt.



PN 12093 Set Includes Tweezer and Glove

Accessories

Description	Part #	Price
Statement of Accuracy	36092	\$47.50
Weight glove, white cotton	11714	\$6.75
Tweezer	11711	\$5.00
Premium tweezer	152414	\$43.00
Serial number	25836	\$17.00

ASTM
PRECISION

OIML
PRECISION

BALANCE
CALIBRATION

STAINLESS
FIELD WEIGHTS

CAST IRON
FIELD WEIGHTS

ASTM
SPECIALTY

ACCESSORIES

MASS REFERENCE STANDARDS / METRIC SETS

RANGE: 20 g

Class 0*(Statement of Accuracy not available)*

Set Range	Part #	Price
20 g - 1 mg	84154	\$2,925.00
20 g - 5 mg	84149	\$3,125.00
20 g - 10 mg	84148	\$2,900.00
20 g - 100 mg	84146	\$2,180.00
20 g - 1 g	84155	\$1,580.00

Certificate

Accredited
Included
Included
Included
Included
Included

Class 1

Set Range	Part #	Price
20 g - 1 mg	12448	\$1,140.00
20 g - 1 mg*	11908	\$1,140.00
20 g - 5 mg	12450	\$980.00
20 g - 5 mg*	11907	\$980.00
20 g - 10 mg	12451	\$940.00
20 g - 10 mg*	11906	\$940.00
20 g - 100 mg	84145	\$795.00
20 g - 100 mg*	11905	\$795.00
20 g - 1 g	12452	\$660.00
20 g - 1 g*	11904	\$660.00

Optional Certificate

Accredited	Non-accredited
\$705.00	\$560.00
\$705.00	\$560.00
\$595.00	\$470.00
\$595.00	\$470.00
\$545.00	\$440.00
\$545.00	\$440.00
\$390.00	\$310.00
\$390.00	\$310.00
\$235.00	\$190.00
\$235.00	\$190.00

Class 2

Set Range	Part #	Price
20 g - 1 mg	11853	\$950.00
20 g - 1 mg*	12174	\$950.00
20 g - 5 mg	11858	\$840.00
20 g - 5 mg*	12172	\$840.00
20 g - 10 mg	11863	\$770.00
20 g - 10 mg*	12171	\$770.00
20 g - 100 mg	84144	\$670.00
20 g - 100 mg*	12170	\$670.00
20 g - 1 g	11868	\$570.00
20 g - 1 g*	12169	\$570.00

Optional Certificate

Accredited	Non-accredited
\$705.00	\$560.00
\$705.00	\$560.00
\$595.00	\$470.00
\$595.00	\$470.00
\$545.00	\$440.00
\$545.00	\$440.00
\$390.00	\$310.00
\$390.00	\$310.00
\$235.00	\$190.00
\$235.00	\$190.00

Class 3

Set Range	Part #	Price
20 g - 1 mg	11961	\$860.00
20 g - 1 mg*	12311	\$860.00
20 g - 5 mg	11966	\$775.00
20 g - 5 mg*	12309	\$775.00
20 g - 10 mg	11971	\$700.00
20 g - 10 mg*	22188	\$700.00
20 g - 100 mg	84143	\$625.00
20 g - 100 mg*	22187	\$625.00
20 g - 1 g	11976	\$495.00
20 g - 1 g*	22186	\$495.00

Optional Certificate

Accredited	Non-accredited
\$705.00	\$560.00
\$705.00	\$560.00
\$595.00	\$470.00
\$595.00	\$470.00
\$545.00	\$440.00
\$545.00	\$440.00
\$390.00	\$310.00
\$390.00	\$310.00
\$235.00	\$190.00
\$235.00	\$190.00

Class 4

Set Range	Part #	Price
20 g - 1 mg	12108	\$650.00
20 g - 1 mg*	12414	\$650.00
20 g - 5 mg	12113	\$605.00
20 g - 5 mg*	12412	\$605.00
20 g - 10 mg	12118	\$580.00
20 g - 10 mg*	12411	\$580.00
20 g - 100 mg	84142	\$485.00
20 g - 100 mg*	12410	\$485.00
20 g - 1 g	12123	\$395.00
20 g - 1 g*	12409	\$395.00

Optional Certificate

Accredited
\$430.00
\$430.00
\$355.00
\$355.00
\$325.00
\$325.00
\$235.00
\$235.00
\$140.00
\$140.00

* 5-2-2-1 configuration



PN 12108 Set Includes Lifting Device, Glove and Case

RANGE: 20 g

ASTM
PRECISION

Weight Set Contents

5-2-2-1		5-2-2-1		5-2-2-1		5-2-2-1		5-2-2-1	
20g - 1mg	20g - 1mg	20g - 5mg	20g - 5mg	20g - 10mg	20g - 10mg	20g - 100mg	20g - 100mg	20g - 1g	20g - 1g
84154 Class 0	–	84149 Class 0	–	84148 Class 0	–	84146 Class 0	–	84155 Class 0	–
12448 Class 1	11908 Class 1	12450 Class 1	11907 Class 1	12451 Class 1	11906 Class 1	84145 Class 1	11905 Class 1	12452 Class 1	11904 Class 1
11853 Class 2	12174 Class 2	11858 Class 2	12172 Class 2	11863 Class 2	12171 Class 2	84144 Class 2	12170 Class 2	11868 Class 2	12169 Class 2
11961 Class 3	12311 Class 3	11966 Class 3	12309 Class 3	11971 Class 3	22188 Class 3	84143 Class 3	22187 Class 3	11976 Class 3	22186 Class 3
12108 Class 4	12414 Class 4	12113 Class 4	12412 Class 4	12118 Class 4	12411 Class 4	84142 Class 4	12410 Class 4	12123 Class 4	12409 Class 4
(1) 20 g	(1) 20 g	(1) 20 g	(1) 20 g	(1) 20 g	(1) 20 g	(1) 20 g	(1) 20 g	(1) 20 g	(1) 20 g
(1) 10 g	(1) 10 g	(1) 10 g	(1) 10 g	(1) 10 g	(1) 10 g	(1) 10 g	(1) 10 g	(1) 10 g	(1) 10 g
(1) 5 g	(1) 5 g	(1) 5 g	(1) 5 g	(1) 5 g	(1) 5 g	(1) 5 g	(1) 5 g	(1) 5 g	(1) 5 g
(1) 3 g	–	(1) 3 g	–	(1) 3 g	–	(1) 3 g	–	(1) 3 g	–
(1) 2 g	(2) 2 g	(1) 2 g	(2) 2 g	(1) 2 g	(1) 2 g	(1) 2 g	(2) 2 g	(1) 2 g	(2) 2 g
(1) 1 g	(1) 1 g	(1) 1 g	(1) 1 g	(1) 1 g	(1) 1 g	(1) 1 g	(1) 1 g	(1) 1 g	(1) 1 g
(1) 500 mg	(1) 500 mg	(1) 500 mg	(1) 500 mg	(1) 500 mg	(1) 500 mg	(1) 500 mg	(1) 500 mg	(1) 500 mg	
(1) 300 mg	–	(1) 300 mg	–	(1) 300 mg	–	(1) 300 mg	–	–	
(1) 200 mg	(2) 200 mg	(1) 200 mg	(2) 200 mg	(1) 200 mg	(2) 200 mg	(1) 200 mg	(2) 200 mg		
(1) 100 mg	(1) 100 mg	(1) 100 mg	(1) 100 mg	(1) 100 mg	(1) 100 mg	(1) 100 mg	(1) 100 mg		
(1) 50 mg	(1) 50 mg	(1) 50 mg	(1) 50 mg	(1) 50 mg	(1) 50 mg				
(1) 30 mg	–	(1) 30 mg	–	(1) 30 mg	–				
(1) 20 mg	(2) 20 mg	(1) 20 mg	(2) 20 mg	(1) 20 mg	(2) 20 mg				
(1) 10 mg	(1) 10 mg	(1) 10 mg	(1) 10 mg	(1) 10 mg	(1) 10 mg				
(1) 5 mg	(1) 5 mg	(1) 5 mg	(1) 5 mg						
(1) 3 mg	–								
(1) 2 mg	(2) 2 mg								
(1) 1 mg	(1) 1 mg								
18 pcs. 42.221g set wt.	18 pcs. 42.221g set wt.	15 pcs. 42.215g set wt.	15 pcs. 42.215g set wt.	14 pcs. 42.421g set wt.	14 pcs. 41.1g set wt.	10 pcs. 41g set wt.	10 pcs. 41g set wt.	6 pcs. 41g set wt.	6 pcs. 40g set wt.

OIML
PRECISION

BALANCE
CALIBRATION

STAINLESS
FIELD WEIGHTS

CAST IRON
FIELD WEIGHTS

ASTM
SPECIALTY

ACCESSORIES

Replacement Cases

Main Cases		
Class 0		
Set Range	Part #	Price
20 g - 1mg	49503	\$250.00
20 g - 5 mg	49503	\$250.00
20 g - 10 mg	49503	\$250.00
20 g - 100 mg	49503	\$250.00
20 g - 1g	49503	\$250.00

Main Case		
Class 1, 2 and 3		
Set Range	Part #	Price
20 g - 1mg	11596	\$180.00
20 g - 1mg	11588	\$180.00
20 g - 5 mg	11596	\$180.00
20 g - 5 mg	11588	\$180.00
20 g - 10 mg	11596	\$180.00
20 g - 10 mg	11588	\$180.00
20 g - 100 mg	11596	\$180.00
20 g - 100 mg	11588	\$180.00
20 g - 1g	11596	\$180.00
20 g - 1g	11588	\$180.00

Main Cases		
Class 4		
Set Range	Part #	Price
20 g - 1mg	11596	\$180.00
20 g - 1mg	11588	\$180.00
20 g - 5 mg	11596	\$180.00
20 g - 5 mg	11588	\$180.00
20 g - 10 mg	11596	\$180.00
20 g - 10 mg	11588	\$180.00
20 g - 100 mg	11596	\$180.00
20 g - 100 mg	11588	\$180.00
20 g - 1g	11596	\$180.00
20 g - 1g	11588	\$180.00

Accessories

Description	Part #	Price
Statement of Accuracy	36092	\$47.50
Weight glove, white cotton	11714	\$6.75
Tweezer	11711	\$5.00
Premium tweezer	152414	\$43.00
Serial number	25836	\$17.00
Leaf weight cover	11755	\$43.00

MASS REFERENCE STANDARDS / METRIC SETS

RANGE: 50 g

Class 0

Statement of Accuracy not available.

Set Range	Part #	Price
50 g - 1 mg	84177	\$3,775.00
50 g - 5 mg	84176	\$3,525.00
50 g - 10 mg	84164	\$3,200.00
50 g - 100 mg	84163	\$2,420.00
50 g - 1 g	84178	\$1,890.00

Certificate

Accredited
Included
Included
Included
Included
Included

Class 1

Set Range	Part #	Price
50 g - 1 mg	12453	\$1,120.00
50 g - 1 mg*	11903	\$1,120.00
50 g - 5 mg	12454	\$1,040.00
50 g - 5 mg*	11902	\$1,040.00
50 g - 10 mg	12455	\$985.00
50 g - 10 mg*	11900	\$985.00
50 g - 100 mg	84159	\$855.00
50 g - 100 mg*	11899	\$855.00
50 g - 1 g	12456	\$710.00
50 g - 1 g*	11898	\$725.00

Optional Certificate

Accredited	Non-accredited
\$790.00	\$630.00
\$790.00	\$630.00
\$670.00	\$530.00
\$670.00	\$530.00
\$630.00	\$500.00
\$630.00	\$500.00
\$470.00	\$375.00
\$470.00	\$375.00
\$310.00	\$250.00
\$310.00	\$250.00

Class 2

Set Range	Part #	Price
50 g - 1 mg	11873	\$985.00
50 g - 1 mg*	12167	\$985.00
50 g - 5 mg	11879	\$900.00
50 g - 5 mg*	12165	\$900.00
50 g - 10 mg	11880	\$855.00
50 g - 10 mg*	12163	\$855.00
50 g - 100 mg	84160	\$685.00
50 g - 100 mg*	12162	\$685.00
50 g - 1 g	11890	\$615.00
50 g - 1 g*	12161	\$615.00

Optional Certificate

Accredited	Non-accredited
\$790.00	\$630.00
\$790.00	\$630.00
\$670.00	\$530.00
\$670.00	\$530.00
\$630.00	\$500.00
\$630.00	\$500.00
\$470.00	\$375.00
\$470.00	\$375.00
\$310.00	\$250.00
\$310.00	\$250.00

Class 3

Set Range	Part #	Price
50 g - 1 mg	11982	\$925.00
50 g - 1 mg*	22288	\$925.00
50 g - 5 mg	11988	\$815.00
50 g - 5 mg*	22182	\$815.00
50 g - 10 mg	11989	\$785.00
50 g - 10 mg*	22181	\$785.00
50 g - 100 mg	84161	\$650.00
50 g - 100 mg*	12300	\$650.00
50 g - 1 g	12004	\$565.00
50 g - 1 g*	12299	\$565.00

Optional Certificate

Accredited	Non-accredited
\$790.00	\$630.00
\$790.00	\$630.00
\$670.00	\$530.00
\$670.00	\$530.00
\$630.00	\$500.00
\$630.00	\$500.00
\$470.00	\$375.00
\$470.00	\$375.00
\$310.00	\$250.00
\$310.00	\$250.00

Class 4

Set Range	Part #	Price
50 g - 1 mg	12128	\$785.00
50 g - 1 mg*	12407	\$785.00
50 g - 5 mg	12134	\$715.00
50 g - 5 mg*	12405	\$715.00
50 g - 10 mg	12135	\$690.00
50 g - 10 mg*	12404	\$690.00
50 g - 100 mg	84162	\$590.00
50 g - 100 mg*	12403	\$590.00
50 g - 1 g	12150	\$495.00
50 g - 1 g*	12402	\$495.00

Optional Certificate

Accredited
\$475.00
\$475.00
\$400.00
\$400.00
\$380.00
\$380.00
\$280.00
\$280.00
\$190.00
\$190.00

* 5-2-2-1 configuration



PN 12453 Set Includes Lifting Device, Glove and Case

RANGE: 50 g

ASTM
PRECISION

Weight Set Contents

5-2-2-1		5-2-2-1		5-2-2-1		5-2-2-1		5-2-2-1	
50 g - 1mg	50 g - 1mg	50 g - 5mg	50 g - 5mg	50 g - 10mg	50 g - 10mg	50 g - 100mg	50 g - 100mg	50 g - 1g	50 g - 1g
84177 Class 0	–	84176 Class 0	–	84164 Class 0	–	84163 Class 0	–	84178 Class 0	–
12453 Class 1	11903 Class 1	12454 Class 1	11902 Class 1	12455 Class 1	11900 Class 1	84159 Class 1	11899 Class 1	12456 Class 1	11898 Class 1
11873 Class 2	12167 Class 2	11879 Class 2	12165 Class 2	11880 Class 2	12163 Class 2	84160 Class 2	12162 Class 2	11890 Class 2	12161 Class 2
11982 Class 3	22288 Class 3	11988 Class 3	22182 Class 3	11989 Class 3	22181 Class 3	84161 Class 3	12300 Class 3	12004 Class 3	12299 Class 3
12128 Class 4	12407 Class 4	12134 Class 4	12405 Class 4	12135 Class 4	12404 Class 4	84162 Class 4	12403 Class 4	12150 Class 4	12402 Class 4
(1) 50 g	(1) 50 g	(1) 50 g	(1) 50 g	(1) 50 g	(1) 50 g	(1) 50 g	(1) 50 g	(1) 50 g	(1) 50 g
(1) 30 g	–	(1) 30 g	–	(1) 30 g	–	(1) 30 g	–	(1) 30 g	–
(1) 20 g	(2) 20 g	(1) 20 g	(2) 20 g	(1) 20 g	(2) 20 g	(1) 20 g	(2) 20 g	(1) 20 g	(2) 20 g
(1) 10 g	(1) 10 g	(1) 10 g	(1) 10 g	(1) 10 g	(1) 10 g	(1) 10 g	(1) 10 g	(1) 10 g	(1) 10 g
(1) 5 g	(1) 5 g	(1) 5 g	(1) 5 g	(1) 5 g	(1) 5 g	(1) 5 g	(1) 5 g	(1) 5 g	(1) 5 g
(1) 3 g	–	(1) 3 g	–	(1) 3 g	–	(1) 3 g	–	(1) 3 g	–
(1) 2 g	(2) 2 g	(1) 2 g	(2) 2 g	(1) 2 g	(2) 2 g	(1) 2 g	(2) 2 g	(1) 2 g	(2) 2 g
(1) 1 g	(1) 1 g	(1) 1 g	(1) 1 g	(1) 1 g	(1) 1 g	(1) 1 g	(1) 1 g	(1) 1 g	(1) 1 g
(1) 500 mg	(1) 500 mg	(1) 500 mg	(1) 500 mg	(1) 500 mg	(1) 500 mg	(1) 500 mg	(1) 500 mg		
(1) 300 mg	–	(1) 300 mg	–	(1) 300 mg	–	(1) 300 mg	–		
(1) 200 mg	(2) 200 mg	(1) 200 mg	(2) 200 mg	(1) 200 mg	(2) 200 mg	(1) 200 mg	(2) 200 mg		
(1) 100 mg	(1) 100 mg	(1) 100 mg	(1) 100 mg	(1) 100 mg	(1) 100 mg	(1) 100 mg	(1) 100 mg		
(1) 50 mg	(1) 50 mg	(1) 50 mg	(1) 50 mg	(1) 50 mg	(1) 50 mg				
(1) 30 mg	–	(1) 30 mg	–	(1) 30 mg	–				
(1) 20 mg	(2) 20 mg	(1) 20 mg	(2) 20 mg	(1) 20 mg	(2) 20 mg				
(1) 10 mg	(1) 10 mg	(1) 10 mg	(1) 10 mg	(1) 10 mg	(1) 10 mg				
(1) 5 mg	(1) 5 mg	(1) 5 mg	(1) 5 mg						
(1) 3 mg	(2) 2 mg								
(1) 2 mg	(1) 1 mg								
(1) 1 mg									
20 pcs. 122.221g set wt.	20 pcs. 111.11g set wt.	17 pcs. 122.215g set wt.	17 pcs. 111.105g set wt.	16 pcs. 122.21g set wt.	16 pcs. 111.11g set wt.	12 pcs. 122.1g set wt.	12 pcs. 111g set wt.	8 pcs. 121g set wt.	8 pcs. 110g set wt.

OIML
PRECISION

BALANCE
CALIBRATION

STAINLESS
FIELD WEIGHTS

CAST IRON
FIELD WEIGHTS

ASTM
SPECIALTY

Replacement Cases

Main Cases		
Class 0		
Set Range	Part #	Price
50 g - 1mg	49503	\$250.00
50 g - 5mg	49503	\$250.00
50 g - 10mg	49503	\$250.00
50 g - 100mg	49503	\$250.00
50 g - 1g	49503	\$250.00

Main Case		
Class 1, 2 and 3		
Set Range	Part #	Price
50 g - 1mg	11596	\$180.00
50 g - 1mg	11588	\$180.00
50 g - 5mg	11596	\$180.00
50 g - 5mg	11588	\$180.00
50 g - 10mg	11596	\$180.00
50 g - 10mg	11588	\$180.00
50 g - 100mg	11596	\$180.00
50 g - 100mg	11588	\$180.00
50 g - 1g	11596	\$180.00
50 g - 1g	11588	\$180.00

Main Cases		
Class 4		
Set Range	Part #	Price
50 g - 1mg	11596	\$180.00
50 g - 1mg	11588	\$180.00
50 g - 5mg	11596	\$180.00
50 g - 5mg	11588	\$180.00
50 g - 10mg	11596	\$180.00
50 g - 10mg	11588	\$180.00
50 g - 100mg	11596	\$180.00
50 g - 100mg	11588	\$180.00
50 g - 1g	11596	\$180.00
50 g - 1g	11588	\$180.00

Accessories

Description	Part #	Price
Statement of Accuracy	36092	\$47.50
Weight glove, white cotton	11714	\$6.75
Tweezer	11711	\$5.00
Premium tweezer	152414	\$43.00
Serial number	25836	\$17.00
Leaf weight cover	11755	\$43.00

ACCESSORIES

MASS REFERENCE STANDARDS / METRIC SETS

RANGE: 100 g

Class 0

Statement of Accuracy not available

Set Range	Part #	Price
100 g - 1 mg	45930	\$4,150.00
100 g - 5 mg	84211	\$3,625.00
100 g - 10 mg	84212	\$3,350.00
100 g - 100 mg	45931	\$2,775.00
100 g - 1 g	45932	\$2,010.00

Certificate

Accredited
Included
Included
Included
Included
Included

Class 1

Set Range	Part #	Price
100 g - 1 mg	12457	\$1,210.00
100 g - 1 mg*	11897	\$1,210.00
100 g - 5 mg	11911	\$1,080.00
100 g - 5 mg*	11896	\$1,080.00
100 g - 10 mg	12460	\$1,060.00
100 g - 10 mg*	11895	\$1,060.00
100 g - 100 mg	45956	\$860.00
100 g - 100 mg*	45948	\$860.00
100 g - 1 g	12461	\$775.00
100 g - 1 g*	11894	\$775.00

Optional Certificate

Accredited	Non-accredited
\$830.00	\$620.00
\$830.00	\$620.00
\$705.00	\$540.00
\$705.00	\$540.00
\$670.00	\$530.00
\$670.00	\$530.00
\$510.00	\$405.00
\$510.00	\$405.00
\$355.00	\$280.00
\$355.00	\$280.00

Class 2

Set Range	Part #	Price
100 g - 1 mg	11901	\$1,060.00
100 g - 1 mg*	12160	\$1,060.00
100 g - 5 mg	12158	\$945.00
100 g - 5 mg*	-	Consult
100 g - 10 mg	11912	\$925.00
100 g - 10 mg*	12157	\$925.00
100 g - 100 mg	45957	\$900.00
100 g - 100 mg*	45949	\$900.00
100 g - 1 g	11913	\$775.00
100 g - 1 g*	12156	\$765.00

Optional Certificate

Accredited	Non-accredited
\$830.00	\$620.00
\$830.00	\$620.00
\$705.00	\$540.00
\$705.00	\$540.00
\$670.00	\$530.00
\$670.00	\$530.00
\$510.00	\$405.00
\$510.00	\$405.00
\$355.00	\$280.00
\$355.00	\$280.00

Class 3

Set Range	Part #	Price
100 g - 1 mg	12018	\$1,000.00
100 g - 1 mg*	12298	\$1,000.00
100 g - 5 mg	12031	\$885.00
100 g - 5 mg*	12296	\$885.00
100 g - 10 mg	12035	\$880.00
100 g - 10 mg*	12295	\$880.00
100 g - 100 mg	45958	\$835.00
100 g - 100 mg*	45950	\$835.00
100 g - 1 g	12045	\$745.00
100 g - 1 g*	12294	\$745.00

Optional Certificate

Accredited	Non-accredited
\$830.00	\$620.00
\$830.00	\$620.00
\$705.00	\$540.00
\$705.00	\$540.00
\$670.00	\$530.00
\$670.00	\$530.00
\$510.00	\$405.00
\$510.00	\$405.00
\$355.00	\$280.00
\$355.00	\$280.00

Class 4

Set Range	Part #	Price
100 g - 1 mg	12164	\$910.00
100 g - 1 mg*	12401	\$910.00
100 g - 5 mg	12177	\$885.00
100 g - 5 mg*	12399	\$885.00
100 g - 10 mg	12181	\$880.00
100 g - 10 mg*	12398	\$880.00
100 g - 100 mg	45959	\$740.00
100 g - 100 mg*	45951	\$740.00
100 g - 1 g	12191	\$645.00
100 g - 1 g*	12397	\$645.00

Optional Certificate

Accredited
\$505.00
\$505.00
\$430.00
\$430.00
\$395.00
\$395.00
\$305.00
\$305.00
\$215.00
\$215.00

* 5-2-2-1 configuration



PN 12457 Set Includes Lifting Device, Glove and Case

RANGE: 100 g

ASTM
PRECISION

Weight Set Contents

5-2-2-1		5-2-2-1		5-2-2-1		5-2-2-1		5-2-2-1	
100 g - 1mg	100 g - 1mg	100 g - 5 mg	100 g - 5 mg	100 g - 10 mg	100 g - 10 mg	100 g - 100 mg	100 g - 100 mg	100 g - 1g	100 g - 1g
45930 Class 0	–	84211 Class 0	–	84212 Class 0	–	45931 Class 0	–	45932 Class 0	–
12457 Class 1	11897 Class 1	11911 Class 1	11896 Class 1	12460 Class 1	11895 Class 1	45956 Class 1	45948 Class 1	12461 Class 1	11894 Class 1
11901 Class 2	12160 Class 2	12158 Class 2	–	11912 Class 2	12157 Class 2	45957 Class 2	45949 Class 2	11913 Class 2	12156 Class 2
12018 Class 3	12298 Class 3	12031 Class 3	12296 Class 3	12035 Class 3	12295 Class 3	45958 Class 3	45950 Class 3	12045 Class 3	12294 Class 3
12164 Class 4	12401 Class 4	12177 Class 4	12399 Class 4	12181 Class 4	12398 Class 4	45959 Class 4	45951 Class 4	12191 Class 4	12397 Class 4
(1) 100 g	(1) 100 g	(1) 100 g	(1) 100 g	(1) 100 g	(1) 100 g	(1) 100 g	(1) 100 g	(1) 100 g	(1) 100 g
(1) 50 g	(1) 50 g	(1) 50 g	(1) 50 g	(1) 50 g	(1) 50 g	(1) 50 g	(1) 50 g	(1) 50 g	(1) 50 g
(1) 30 g	–	(1) 30 g	–	(1) 30 g	–	(1) 30 g	–	(1) 30 g	–
(1) 20 g	(2) 20 g	(1) 20 g	(2) 20 g	(1) 20 g	(2) 20 g	(1) 20 g	(2) 20 g	(1) 20 g	(2) 20 g
(1) 10 g	(1) 10 g	(1) 10 g	(1) 10 g	(1) 10 g	(1) 10 g	(1) 10 g	(1) 10 g	(1) 10 g	(1) 10 g
(1) 5 g	(1) 5 g	(1) 5 g	(1) 5 g	(1) 5 g	(1) 5 g	(1) 5 g	(1) 5 g	(1) 5 g	(1) 5 g
(1) 3 g	–	(1) 3 g	–	(1) 3 g	–	(1) 3 g	–	(1) 3 g	–
(1) 2 g	(2) 2 g	(1) 2 g	(2) 2 g	(1) 2 g	(2) 2 g	(1) 2 g	(2) 2 g	(1) 2 g	(2) 2 g
(1) 1 g	(1) 1 g	(1) 1 g	(1) 1 g	(1) 1 g	(1) 1 g	(1) 1 g	(1) 1 g	(1) 1 g	(1) 1 g
(1) 500 mg	(1) 500 mg	(1) 500 mg	(1) 500 mg	(1) 500 mg	(1) 500 mg	(1) 500 mg	(1) 500 mg	(1) 500 mg	
(1) 300 mg	–	(1) 300 mg	–	(1) 300 mg	–	(1) 300 mg	–	(1) 300 mg	
(1) 200 mg	(2) 200 mg	(1) 200 mg	(2) 200 mg	(1) 200 mg	(2) 200 mg	(1) 200 mg	(2) 200 mg	(1) 200 mg	
(1) 100 mg	(1) 100 mg	(1) 100 mg	(1) 100 mg	(1) 100 mg	(1) 100 mg	(1) 100 mg	(1) 100 mg	(1) 100 mg	
(1) 50 mg	(1) 50 mg	(1) 50 mg	(1) 50 mg	(1) 50 mg	(1) 50 mg	(1) 50 mg			
(1) 30 mg	–	(1) 30 mg	–	(1) 30 mg	–				
(1) 20 mg	(2) 20 mg	(1) 20 mg	(2) 20 mg	(1) 20 mg	(2) 20 mg				
(1) 10 mg	(1) 10 mg	(1) 10 mg	(1) 10 mg	(1) 10 mg	(1) 10 mg				
(1) 5 mg	(1) 5 mg	(1) 5 mg	(1) 5 mg						
(1) 3 mg	–								
(1) 2 mg	(2) 2 mg								
(1) 1 mg	(1) 1 mg								
21 pcs. 222.221g set wt.	21 pcs. 211.11g set wt.	18 pcs. 222.215g set wt.	18 pcs. 211.085g set wt.	17 pcs. 222.21g set wt.	17 pcs. 211.1g set wt.	13 pcs. 222.1g set wt.	13 pcs. 211g set wt.	9 pcs. 221g set wt.	9 pcs. 210g set wt.

OIML
PRECISION

BALANCE
CALIBRATION

STAINLESS
FIELD WEIGHTS

CAST IRON
FIELD WEIGHTS

ASTM
SPECIALTY

Replacement Cases

Main Cases		
Class 0		
Set Range	Part #	Price
100 g - 1mg	49503	\$250.00
100 g - 5 mg	49503	\$250.00
100 g - 10 mg	49503	\$250.00
100 g - 100 mg	49503	\$250.00
100 g - 1g	49503	\$250.00

Main Case		
Class 1, 2 and 3		
Set Range	Part #	Price
100 g - 1mg	11596	\$180.00
100 g - 1mg	11588	\$180.00
100 g - 5 mg	11596	\$180.00
100 g - 5 mg	11588	\$180.00
100 g - 10 mg	11596	\$180.00
100 g - 10 mg	11588	\$180.00
100 g - 100 mg	11596	\$180.00
100 g - 100 mg	11588	\$180.00

Main Case		
Class 4		
Set Range	Part #	Price
100 g - 1mg	11596	\$180.00
100 g - 1mg	11588	\$180.00
100 g - 5 mg	11596	\$180.00
100 g - 5 mg	11588	\$180.00
100 g - 10 mg	11596	\$180.00
100 g - 10 mg	11588	\$180.00
100 g - 100 mg	11596	\$180.00
100 g - 100 mg	11588	\$180.00
100 g - 1g	11596	\$180.00
100 g - 1g	11588	\$180.00

Accessories

Description	Part #	Price
Statement of Accuracy	36092	\$47.50
Weight glove, white cotton	11714	\$6.75
Tweezer	11711	\$5.00
Premium tweezer	152414	\$43.00
Serial number	25836	\$17.00
Leaf weight cover	11755	\$43.00

ACCESSORIES

MASS REFERENCE STANDARDS / METRIC SETS

RANGE: 200 g

Class 0

Statement of Accuracy not available.

Set Range	Part #	Price
200 g - 1mg	45927	\$4,575.00
200 g - 1mg*	156298	\$4,575.00
(2) 200 g - 1mg*	87039	\$5,100.00
200 g - 10 mg	84213	\$4,125.00
(2) 200 g - 10 mg*	87038	\$4,425.00
200 g - 100 mg	45928	\$3,575.00
(2) 200 g - 100 mg*	87037	\$3,825.00
200 g - 1g	45929	\$2,400.00
(2) 200 g - 1g*	87040	\$2,850.00

Certificate

Accredited
Included
Included
Included
Included
Included
Included
Included
Included
Included
Included

Class 1

Set Range	Part #	Price
200 g - 1mg	12462	\$1,290.00
200 g - 1mg*	156299	\$1,290.00
(2) 200 g - 1mg*	87053	\$1,370.00
200 g - 10 mg	12467	\$1,180.00
(2) 200 g - 10 mg*	87049	\$1,350.00
200 g - 100 mg	45960	\$1,140.00
(2) 200 g - 100 mg*	87045	\$1,300.00
200 g - 1g	12468	\$960.00
200 g - 1g*	11893	\$960.00
(2) 200 g - 1g*	87057	\$1,100.00

Optional Certificate

Accredited	Non-accredited
\$930.00	\$660.00
\$930.00	\$660.00
\$1,020.00	\$675.00
\$770.00	\$535.00
\$870.00	\$625.00
\$610.00	\$450.00
\$700.00	\$495.00
\$450.00	\$325.00
\$450.00	\$325.00
\$540.00	\$370.00

Class 2

Set Range	Part #	Price
200 g - 1mg	11914	\$1,240.00
200 g - 1mg*	156300	\$1,240.00
(2) 200 g - 1mg*	87054	\$1,290.00
200 g - 10 mg	11916	\$1,010.00
(2) 200 g - 10 mg*	87050	\$1,260.00
200 g - 100 mg	45961	\$970.00
(2) 200 g - 100 mg*	87046	\$1,230.00
200 g - 1g	11917	\$900.00
200 g - 1g*	12154	\$900.00
(2) 200 g - 1g*	87058	\$930.00

Optional Certificate

Accredited	Non-accredited
\$930.00	\$660.00
\$930.00	\$660.00
\$1,020.00	\$675.00
\$770.00	\$535.00
\$870.00	\$625.00
\$610.00	\$450.00
\$700.00	\$495.00
\$450.00	\$325.00
\$450.00	\$325.00
\$540.00	\$370.00

Class 3

Set Range	Part #	Price
200 g - 1mg	12051	\$1,220.00
200 g - 1mg*	156301	\$1,220.00
(2) 200 g - 1mg*	87055	\$1,290.00
200 g - 10 mg	12064	\$985.00
(2) 200 g - 10 mg*	87051	\$1,230.00
200 g - 100 mg	45962	\$900.00
(2) 200 g - 100 mg*	87047	\$1,220.00
200 g - 1g	12065	\$890.00
200 g - 1g*	12292	\$890.00
(2) 200 g - 1g*	87059	\$925.00

Optional Certificate

Accredited	Non-accredited
\$930.00	\$660.00
\$930.00	\$660.00
\$1,020.00	\$675.00
\$770.00	\$535.00
\$870.00	\$625.00
\$610.00	\$450.00
\$700.00	\$495.00
\$450.00	\$325.00
\$450.00	\$325.00
\$540.00	\$370.00

Class 4

Set Range	Part #	Price
200 g - 1mg	12197	\$960.00
200 g - 1mg*	156302	\$960.00
(2) 200 g - 1mg*	87056	\$1,040.00
200 g - 10 mg	12210	\$915.00
(2) 200 g - 10 mg*	87052	\$1,000.00
200 g - 100 mg	45963	\$820.00
(2) 200 g - 100 mg*	87048	\$960.00
200 g - 1g	12211	\$700.00
200 g - 1g*	12395	\$700.00
(2) 200 g - 1g*	87060	\$815.00

Optional Certificate

Accredited
\$530.00
\$530.00
\$560.00
\$440.00
\$470.00
\$340.00
\$375.00
\$245.00
\$245.00
\$280.00

* 5-2-2-1 configuration

Weight Set Contents

5-2-2-1

200 g - 1 mg		200 g - 1 mg	
45927 Class 0		156298 Class 0	
12462 Class 1		156299 Class 1	
11914 Class 2		156300 Class 2	
12051 Class 3		156301 Class 3	
12197 Class 4		156302 Class 4	
(1) 200 g		(1) 200 g	
(1) 100 g		(1) 100 g	
(1) 50 g		(1) 50 g	
(1) 30 g		-	
(1) 20 g		(2) 20 g	
(1) 10 g		(1) 10 g	
(1) 5 g		(1) 5 g	
(1) 3 g		-	
(1) 2 g		(2) 2 g	
(1) 1 g		(1) 1 g	
(1) 500 mg		(1) 500 mg	
(1) 300 mg		-	
(1) 200 mg		(2) 200 mg	
(1) 100 mg		(1) 100 mg	
(1) 50 mg		(1) 50 mg	
(1) 30 mg		-	
(1) 20 mg		(2) 20 mg	
(1) 10 mg		(1) 10 mg	
(1) 5 mg		(1) 5 mg	
(1) 3 mg		-	
(1) 2 mg		(2) 2 mg	
(1) 1 mg		(1) 1 mg	
22 pcs. 422.221g set wt.		22 pcs. 422.221g set wt.	



PN 12462 Set Includes Lifting Device, Glove and Case

RANGE: 200 g

Weight Set Contents

5-2-2-1		5-2-2-1		5-2-2-1		5-2-2-1		5-2-2-1		5-2-2-1	
(2) 200 g - 1mg		200 g - 10 mg		(2) 200 g - 10 mg		200 g - 100 mg		(2) 200 g - 100 mg		200 g - 1g	
87039 Class 0	84213 Class 0	87038 Class 0	45928 Class 0	87037 Class 0	45929 Class 0	-	87040 Class 0	(2) 200 g	(1) 200 g	(1) 200 g	(2) 200 g
87053 Class 1	12467 Class 1	87049 Class 1	45960 Class 1	87045 Class 1	12468 Class 1	11893 Class 1	87057 Class 1	(1) 100 g	(1) 100 g	(1) 100 g	(1) 100 g
87054 Class 2	11916 Class 2	87050 Class 2	45961 Class 2	87046 Class 2	11917 Class 2	12154 Class 2	87058 Class 2	(1) 50 g	(1) 50 g	(1) 50 g	(1) 50 g
87055 Class 3	12064 Class 3	87051 Class 3	45962 Class 3	87047 Class 3	12065 Class 3	12292 Class 3	87059 Class 3	-	(1) 30 g	-	-
87056 Class 4	12210 Class 4	87052 Class 4	45963 Class 4	87048 Class 4	12211 Class 4	12395 Class 4	87060 Class 4	(2) 20 g	(1) 20 g	(2) 20 g	(2) 20 g
(1) 100 g	(1) 100 g	(1) 100 g	(1) 100 g	(1) 100 g	(1) 100 g	(1) 100 g	(1) 100 g	(1) 10 g	(1) 10 g	(1) 10 g	(1) 10 g
(1) 50 g	(1) 50 g	(1) 50 g	(1) 50 g	(1) 50 g	(1) 50 g	(1) 50 g	(1) 50 g	(1) 5 g	(1) 5 g	(1) 5 g	(1) 5 g
-	(1) 30 g	-	(1) 30 g	-	(1) 30 g	-	(1) 30 g	-	(1) 3 g	-	-
(2) 20 g	(1) 20 g	(2) 20 g	(1) 20 g	(2) 20 g	(1) 20 g	(2) 20 g	(2) 20 g	(2) 2 g	(1) 2 g	(2) 2 g	(2) 2 g
(1) 10 g	(1) 10 g	(1) 10 g	(1) 10 g	(1) 10 g	(1) 10 g	(1) 10 g	(1) 10 g	(1) 1 g	(1) 1 g	(1) 1 g	(1) 1 g
(1) 5 g	(1) 5 g	(1) 5 g	(1) 5 g	(1) 5 g	(1) 5 g	(1) 5 g	(1) 5 g	(2) 2 g	(2) 2 g	(2) 2 g	(2) 2 g
-	(1) 3 g	-	(1) 3 g	-	(1) 3 g	-	(1) 3 g	(1) 1 g	(1) 1 g	(1) 1 g	(1) 1 g
(2) 2 g	(1) 2 g	(2) 2 g	(1) 2 g	(2) 2 g	(1) 2 g	(2) 2 g	(2) 2 g	(1) 500 mg	(1) 500 mg	(1) 500 mg	(1) 500 mg
(1) 1 g	(1) 1 g	(1) 1 g	(1) 1 g	(1) 1 g	(1) 1 g	(1) 1 g	(1) 1 g	-	(1) 300 mg	-	-
(1) 500 mg	(1) 500 mg	(1) 500 mg	(1) 500 mg	(1) 500 mg	(1) 500 mg	(1) 500 mg	(1) 500 mg	(2) 200 mg	(1) 200 mg	(2) 200 mg	(2) 200 mg
-	(1) 300 mg	-	(1) 300 mg	-	(1) 300 mg	-	(1) 300 mg	(1) 100 mg	(1) 100 mg	(1) 100 mg	(1) 100 mg
(2) 200 mg	(1) 200 mg	(2) 200 mg	(1) 200 mg	(2) 200 mg	(1) 200 mg	(2) 200 mg	(2) 200 mg	(1) 50 mg	(1) 50 mg	(1) 50 mg	(1) 50 mg
(1) 100 mg	(1) 100 mg	(1) 100 mg	(1) 100 mg	(1) 100 mg	(1) 100 mg	(1) 100 mg	(1) 100 mg	-	(1) 30 mg	-	-
(1) 50 mg	(1) 50 mg	(1) 50 mg	(1) 50 mg	(1) 50 mg	(1) 50 mg	(1) 50 mg	(1) 50 mg	(2) 20 mg	(1) 20 mg	(2) 20 mg	(2) 20 mg
-	(1) 30 mg	-	(1) 30 mg	-	(1) 30 mg	-	(1) 30 mg	(1) 10 mg	(1) 10 mg	(1) 10 mg	(1) 10 mg
(2) 20 mg	(1) 20 mg	(2) 20 mg	(1) 20 mg	(2) 20 mg	(1) 20 mg	(2) 20 mg	(2) 20 mg	(1) 5 mg	(1) 5 mg	(1) 5 mg	(1) 5 mg
(1) 10 mg	(1) 10 mg	(1) 10 mg	(1) 10 mg	(1) 10 mg	(1) 10 mg	(1) 10 mg	(1) 10 mg	-	-	-	-
(1) 5 mg	-	-	-	-	-	-	-	(2) 2 mg	(2) 2 mg	(2) 2 mg	(2) 2 mg
-	(2) 2 mg	-	(2) 2 mg	-	(2) 2 mg	-	(2) 2 mg	(1) 1 mg	(1) 1 mg	(1) 1 mg	(1) 1 mg
(2) 2 mg	(1) 1 mg	(2) 2 mg	(1) 1 mg	(2) 2 mg	(1) 1 mg	(2) 2 mg	(2) 2 mg	23 pcs.	18 pcs.	19 pcs.	14 pcs.
(1) 1 mg	(1) 1 mg	(1) 1 mg	(1) 1 mg	(1) 1 mg	(1) 1 mg	(1) 1 mg	(1) 1 mg	622.221g set wt.	422.210g set wt.	611.1g set wt.	422.19g set wt.
23 pcs.	18 pcs.	19 pcs.	14 pcs.	15 pcs.	10 pcs.	10 pcs.	11 pcs.				
622.221g set wt.	422.210g set wt.	611.1g set wt.	422.19g set wt.	611g set wt.	421g set wt.	410g set wt.	610g set wt.				

Replacement Cases

Main Cases		
Class 0		
Set Range	Part #	Price
200 g - 1mg	34645	\$330.00
200 g - 1mg	34645	\$330.00
(2) 200 g - 1mg	34645	\$330.00
200 g - 10 mg	34645	\$330.00
(2) 200 g - 10 mg	34645	\$330.00
200 g - 100 mg	34645	\$330.00
(2) 200 g - 100 mg	34645	\$330.00
200 g - 1g	34645	\$330.00
(2) 200 g - 1g	34645	\$330.00

Main Case		
Class 1, 2 and 3		
Set Range	Part #	Price
200 g - 1mg	34645	\$330.00
200 g - 1mg	34645	\$330.00
(2) 200 g - 1mg	34645	\$330.00
200 g - 10 mg	34645	\$330.00
(2) 200 g - 10 mg	34645	\$330.00
200 g - 100 mg	34645	\$330.00
(2) 200 g - 100 mg	34645	\$330.00
200 g - 1g	34645	\$330.00
200 g - 1g	34645	\$330.00
(2) 200 g - 1g	34645	\$330.00

Main Cases		
Class 4		
Set Range	Part #	Price
200 g - 1mg	34645	\$330.00
200 g - 1mg	34645	\$330.00
(2) 200 g - 1mg	34645	\$330.00
200 g - 10 mg	34645	\$330.00
(2) 200 g - 10 mg	34645	\$330.00
200 g - 100 mg	34645	\$330.00
(2) 200 g - 100 mg	34645	\$330.00
200 g - 1g	34645	\$330.00
200 g - 1g	34645	\$330.00
(2) 200 g - 1g	34645	\$330.00

Inserts		
Class 0		
Set Range	Part #	Price
200 g - 1mg	50431	\$125.00
(2) 200 g - 1mg	84473	\$400.00
(2) 200 g - 10 mg	84473	\$400.00
(2) 200 g - 100 mg	84473	\$400.00
200 g - 1g	50430	\$125.00
(2) 200 g - 1g	84472	\$400.00

Inserts		
Class 1, 2, 3 and 4		
Set Range	Part #	Price
200 g - 1mg	11601	\$195.00
(2) 200 g - 1g	84465	\$195.00
(2) 200 g - 1mg	84464	\$195.00
200 g - 1g*	11587	\$195.00

Accessories

Description	Part #	Price
Statement of Accuracy	36092	\$47.50
Weight glove, white cotton	11714	\$6.75
Tweezer	11711	\$5.00
Premium tweezer	152414	\$43.00
Serial number	25836	\$17.00
Leaf weight cover	11755	\$43.00
Weight forceps, plastic	50035	\$43.00
Lifter bar	11747	\$21.00

MASS REFERENCE STANDARDS / METRIC SETS

RANGE: 300 g and 500 g

Class 0

Statement of Accuracy not available.

Set Range	Part #	Price
500 g - 1mg	45923	\$5,750.00
500 g - 100 mg	45924	\$4,525.00
500 g - 1g	45925	\$3,750.00
500 g - 100 g	45926	\$2,350.00

Certificate

Accredited
Included
Included
Included
Included

Class 1

Set Range	Part #	Price
300 g - 1g	11892	\$1,610.00
500 g - 1mg	12469	\$2,675.00
500 g - 100 mg	45964	\$2,625.00
500 g - 1g	12472	\$1,760.00
500 g - 1g*	11891	\$1,760.00
500 g - 100 g	45968	\$1,240.00

Optional Certificate

Accredited	Non-accredited
\$540.00	\$370.00
\$1,120.00	\$535.00
\$800.00	\$410.00
\$640.00	\$410.00
\$640.00	\$165.00
\$325.00	\$165.00

Class 2

Set Range	Part #	Price
300 g - 1g	12152	\$1,480.00
500 g - 1mg	11918	\$2,060.00
500 g - 100 mg	45965	\$1,940.00
500 g - 1g	11921	\$1,610.00
500 g - 1g*	12151	\$1,610.00
500 g - 100 g	45969	\$1,140.00

Optional Certificate

Accredited	Non-accredited
\$540.00	\$370.00
\$1,120.00	\$715.00
\$800.00	\$535.00
\$640.00	\$410.00
\$640.00	\$395.00
\$325.00	\$165.00

Class 3

Set Range	Part #	Price
300 g - 1g	12290	\$1,420.00
500 g - 1mg	12066	\$2,010.00
500 g - 100 mg	45966	\$1,840.00
500 g - 1g	12069	\$1,570.00
500 g - 1g*	12289	\$1,570.00
500 g - 100 g	45970	\$1,120.00

Optional Certificate

Accredited	Non-accredited
\$540.00	\$370.00
\$1,120.00	\$715.00
\$800.00	\$535.00
\$640.00	\$410.00
\$640.00	\$395.00
\$325.00	\$165.00

Class 4

Set Range	Part #	Price
300 g - 1g	12393	\$1,310.00
500 g - 1mg	12212	\$1,840.00
500 g - 100 mg	45967	\$1,640.00
500 g - 1g	12215	\$1,450.00
500 g - 1g*	12392	\$1,450.00
500 g - 100 g	45971	\$955.00

Optional Certificate

Accredited
\$280.00
\$605.00
\$375.00
\$310.00
\$310.00
\$125.00

* 5-2-2-1 configuration



PN 12151 Set Includes Lifting Device, Glove and Case (500 g to 1 g)

Replacement Cases

Main Cases		
Class 0		
Set Range	Part #	Price
500 g - 1mg	34645	\$330.00
500 g - 100 mg	34645	\$330.00
500 g - 1g	34645	\$330.00
500 g - 100 g	34645	\$330.00

Main Case		
Class 1, 2 and 3		
Set Range	Part #	Price
300 g - 1g	34645	\$330.00
500 g - 1mg	34645	\$330.00
500 g - 100 mg	34645	\$330.00
500 g - 1g	34645	\$330.00
500 g - 1g	34645	\$330.00
500 g - 100 g	34645	\$330.00

Main Cases		
Class 4		
Set Range	Part #	Price
300 g - 1g	34645	\$330.00
500 g - 1mg	34645	\$330.00
500 g - 100 mg	34645	\$330.00
500 g - 1g	34645	\$330.00
500 g - 1g	34645	\$330.00
500 g - 100 g	34645	\$330.00

RANGE: 300 g and 500 g

ASTM
PRECISION

Weight Set Contents

5-2-2-1

300 g - 1g	500 g - 1mg	500 g - 100 mg	500 g - 1g	500 g - 1g	500 g - 100 g
–	45923 Class 0	45924 Class 0	45925 Class 0	–	45926 Class 0
11892 Class 1	12469 Class 1	45964 Class 1	12472 Class 1	11891 Class 1	45968 Class 1
12152 Class 2	11918 Class 2	45965 Class 2	11921 Class 2	12151 Class 2	45969 Class 2
12290 Class 3	12066 Class 3	45966 Class 3	12069 Class 3	12289 Class 3	45970 Class 3
12393 Class 4	12212 Class 4	45967 Class 4	12215 Class 4	12392 Class 4	45971 Class 4
–	(1) 500 g	(1) 500 g	(1) 500 g	(1) 500 g	(1) 500 g
(1) 300 g	(1) 300 g	(1) 300 g	(1) 300 g	–	(1) 300 g
(1) 200 g	(1) 200 g	(1) 200 g	(1) 200 g	(2) 200 g	(1) 200 g
(1) 100 g	(1) 100 g	(1) 100 g	(1) 100 g	(1) 100 g	(1) 100 g
(1) 50 g	(1) 50 g	(1) 50 g	(1) 50 g	(1) 50 g	
(1) 30 g	(1) 30 g	(1) 30 g	(1) 30 g	–	
(1) 20 g	(1) 20 g	(1) 20 g	(1) 20 g	(2) 20 g	
(1) 10 g	(1) 10 g	(1) 10 g	(1) 10 g	(1) 10 g	
(1) 5 g	(1) 5 g	(1) 5 g	(1) 5 g	(1) 5 g	
(1) 3 g	(1) 3 g	(1) 3 g	(1) 3 g	–	
(1) 2 g	(1) 2 g	(1) 2 g	(1) 2 g	(2) 2 g	
(1) 1g	(1) 1g	(1) 1g	(1) 1g	(1) 1g	
	(1) 500 mg	(1) 500 mg			
	(1) 300 mg	(1) 300 mg			
	(1) 200 mg	(1) 200 mg			
	(1) 100 mg	(1) 100 mg			
	(1) 50 mg				
	(1) 30 mg				
	(1) 20 mg				
	(1) 10 mg				
	(1) 5 mg				
	(1) 3 mg				
	(1) 2 mg				
	(1) 1 mg				
11 pcs. 721g set wt.	24 pcs. 1.222221 kg set wt.	16 pcs. 1.2221 kg set wt.	12 pcs. 1.221 kg set wt.	12 pcs. 1.10 kg set wt.	4 pcs. 1.1 kg set wt.

OIML
PRECISION

BALANCE
CALIBRATION

STAINLESS
FIELD WEIGHTS

CAST IRON
FIELD WEIGHTS

ASTM
SPECIALTY

ACCESSORIES

Accessories

Inserts		
Class 0		
Set Range	Part #	Price
500 g - 1mg	49500	\$260.00
500 g - 100 g	49501	\$205.00

Inserts		
Class 1, 2, 3 and 4		
Set Range	Part #	Price
300 g - 1g	11586	\$195.00
500 g - 1mg	11602	\$195.00
500 g - 1g*	11585	\$195.00

* 5-2-2-1 configuration

Description	Part #	Price
Statement of Accuracy	36092	\$47.50
Weight glove, white cotton	11714	\$6.75
Tweezer	11711	\$5.00
Premium tweezer	152414	\$43.00
Serial number	25836	\$17.00
Leaf weight cover	11755	\$43.00
Weight forceps, plastic	50035	\$43.00
Lifter bar	11747	\$21.00

MASS REFERENCE STANDARDS / METRIC SETS

RANGE: 1kg

Class 0

Statement of Accuracy not available.

Set Range	Part #	Price
1kg - 1mg	45919	\$6,625.00
1kg - 100 mg	45920	\$5,475.00
1kg - 1g	45921	\$4,600.00
1kg - 100 g	45922	\$3,375.00

Certificate

Accredited
Included
Included
Included
Included

Class 1

Set Range	Part #	Price
1kg - 1mg	12473	\$3,175.00
1kg - 100 mg	45972	\$3,100.00
1kg - 1g	12476	\$2,825.00
1kg - 1g*	11889	\$2,825.00
1kg - 100 g	45976	\$2,575.00

Optional Certificate

Accredited	Non-accredited
\$1,210.00	\$765.00
\$900.00	\$525.00
\$730.00	\$455.00
\$730.00	\$455.00
\$415.00	\$205.00

Class 2

Set Range	Part #	Price
1kg - 1mg	11922	\$2,900.00
1kg - 100 mg	45973	\$2,875.00
1kg - 1g	11925	\$2,725.00
1kg - 1g*	12149	\$2,725.00
1kg - 100 g	45977	\$2,490.00

Optional Certificate

Accredited	Non-accredited
\$1,210.00	\$765.00
\$900.00	\$525.00
\$730.00	\$455.00
\$730.00	\$455.00
\$415.00	\$205.00

Class 3

Set Range	Part #	Price
1kg - 1mg	12070	\$2,875.00
1kg - 100 mg	45974	\$2,825.00
1kg - 1g	12073	\$2,600.00
1kg - 1g*	12288	\$2,600.00
1kg - 100 g	45978	\$2,440.00

Optional Certificate

Accredited	Non-accredited
\$1,210.00	\$765.00
\$900.00	\$525.00
\$730.00	\$455.00
\$730.00	\$455.00
\$415.00	\$205.00

Class 4

Set Range	Part #	Price
1kg - 1mg	12216	\$2,650.00
1kg - 100 mg	45975	\$2,600.00
1kg - 1g	12219	\$2,525.00
1kg - 1g*	12391	\$2,440.00
1kg - 100 g	45979	\$2,170.00

Optional Certificate

Accredited
\$630.00
\$445.00
\$350.00
\$350.00
\$155.00

* 5-2-2-1 configuration



PN 12473 Set Includes Lifting Device, Glove and Case (1 kg to 1 mg)

Replacement Cases

Main Cases		
Class 0		
Set Range	Part #	Price
1kg - 1mg	50437	\$1,820.00
1kg - 100 mg	50437	\$1,820.00
1kg - 1g	50437	\$1,820.00
1kg - 100 g	50437	\$1,820.00

Main Case		
Class 1, 2 and 3		
Set Range	Part #	Price
1kg - 1mg	11603	\$1,820.00
1kg - 100 mg	11603	\$1,820.00
1kg - 1g	11603	\$1,820.00
1kg - 1g	11584	\$1,580.00
1kg - 100 g	11603	\$1,820.00

Main Cases		
Class 4		
Set Range	Part #	Price
1kg - 1mg	11603	\$1,820.00
1kg - 100 mg	11603	\$1,820.00
1kg - 1g	11603	\$1,820.00
1kg - 1g	11605	\$1,580.00
1kg - 100 g	11603	\$1,820.00

RANGE: 1kg

ASTM
PRECISION

Weight Set Contents

5-2-2-1

1kg - 1mg	1kg - 100 mg	1kg - 1g	1kg - 1g	1kg - 100 g
45919 Class 0	45920 Class 0	45921 Class 0	–	45922 Class 0
12473 Class 1	45972 Class 1	12476 Class 1	11889 Class 1	45976 Class 1
11922 Class 2	45973 Class 2	11925 Class 2	12149 Class 2	45977 Class 2
12070 Class 3	45974 Class 3	12073 Class 3	12288 Class 3	45978 Class 3
12216 Class 4	45975 Class 4	12219 Class 4	12391 Class 4	45979 Class 4
(1) 1kg	(1) 1kg	(1) 1kg	(1) 1kg	(1) 1kg
(1) 500g	(1) 500g	(1) 500g	(1) 500g	(1) 500g
(1) 300g	(1) 300g	(1) 300g	–	(1) 300g
(1) 200g	(1) 200g	(1) 200g	(2) 200g	(1) 200g
(1) 100g	(1) 100g	(1) 100g	(1) 100g	(1) 100g
(1) 50g	(1) 50g	(1) 50g	(1) 50g	
(1) 30g	(1) 30g	(1) 30g	–	
(1) 20g	(1) 20g	(1) 20g	(2) 20g	
(1) 10g	(1) 10g	(1) 10g	(1) 10g	
(1) 5g	(1) 5g	(1) 5g	(1) 5g	
(1) 3g	(1) 3g	(1) 3g	–	
(1) 2g	(1) 2g	(1) 2g	(2) 2g	
(1) 1g	(1) 1g	(1) 1g	(1) 1g	
(1) 500 mg	(1) 500 mg			
(1) 300 mg	(1) 300 mg			
(1) 200 mg	(1) 200 mg			
(1) 100 mg	(1) 100 mg			
(1) 50 mg				
(1) 30 mg				
(1) 20 mg				
(1) 10 mg				
(1) 5 mg				
(1) 3 mg				
(1) 2 mg				
(1) 1 mg				
25 pcs. 2.22221kg set wt.	17 pcs. 2.2221kg set wt.	13 pcs. 2.221kg set wt.	13 pcs. 2.11kg set wt.	5 pcs. 2.1kg set wt.

OIML
PRECISION

BALANCE
CALIBRATION

STAINLESS
FIELD WEIGHTS

CAST IRON
FIELD WEIGHTS

ASTM
SPECIALTY

ACCESSORIES

Secondary Case		
Class 0		
Set Range	Part #	Price
100g - 1mg	49503	\$250.00

Secondary Case		
Class 1, 2, 3 and 4		
Set Range	Part #	Price
100g - 1mg	11596	\$180.00
100g - 1mg*	11588	\$180.00

* 5-2-2-1 configuration

Inserts		
Class 1, 2, 3 and 4		
Set Range	Part #	Price
100g	46380	\$120.00

Accessories

Description	Part #	Price
Statement of Accuracy	36092	\$47.50
Weight glove, white cotton	11714	\$6.75
Tweezer	11711	\$5.00
Premium tweezer	152414	\$43.00
Serial number	25836	\$17.00
Leaf weight cover	11755	\$43.00
Weight forceps, plastic	50035	\$43.00
Lifter bar	11747	\$21.00
Tong assembly, Class 0	50000	\$74.00

MASS REFERENCE STANDARDS / METRIC SETS

RANGE: 2 kg

Class 0

Statement of Accuracy not available.

Set Range	Part #	Price
2 kg - 1 mg	45915	\$8,475.00
(2) 2 kg - 1 mg*	87043	\$10,150.00
(2) 2 kg - 10 mg*	87042	\$9,625.00
2 kg - 100 mg	45916	\$8,150.00
(2) 2 kg - 100 mg	87041	\$9,000.00
2 kg - 1 g	45917	\$6,100.00
(2) 2 kg - 1 g	87044	\$7,875.00
2 kg - 100 g	45918	\$4,925.00

Certificate

Accredited
Included
Included
Included
Included
Included
Included
Included
Included

Class 1

Set Range	Part #	Price
2 kg - 1 mg	12477	\$4,075.00
(2) 2 kg - 1 mg*	87069	\$4,550.00
(2) 2 kg - 10 mg*	87065	\$4,475.00
2 kg - 100 mg	45980	\$4,325.00
(2) 2 kg - 100 mg*	87061	\$4,425.00
2 kg - 1 g	12480	\$3,450.00
2 kg - 1 g*	11888	\$3,450.00
(2) 2 kg - 1 g*	87073	\$4,225.00
2 kg - 100 g	45984	\$3,325.00

Optional Certificate

Accredited	Non-accredited
\$1,310.00	\$900.00
\$1,430.00	\$960.00
\$1,270.00	\$830.00
\$1,000.00	\$640.00
\$1,120.00	\$700.00
\$840.00	\$510.00
\$840.00	\$510.00
\$960.00	\$570.00
\$520.00	\$260.00

Class 2

Set Range	Part #	Price
2 kg - 1 mg	11926	\$3,625.00
(2) 2 kg - 1 mg*	87070	\$4,375.00
(2) 2 kg - 10 mg*	87066	\$4,075.00
2 kg - 100 mg	45981	\$3,800.00
(2) 2 kg - 100 mg*	87062	\$3,925.00
2 kg - 1 g	11929	\$3,250.00
2 kg - 1 g*	12148	\$3,250.00
(2) 2 kg - 1 g*	87074	\$3,925.00
2 kg - 100 g	45985	\$3,175.00

Optional Certificate

Accredited	Non-accredited
\$1,310.00	\$900.00
\$1,430.00	\$960.00
\$1,270.00	\$830.00
\$1,000.00	\$640.00
\$1,120.00	\$700.00
\$840.00	\$510.00
\$840.00	\$510.00
\$960.00	\$570.00
\$520.00	\$260.00

Class 3

Set Range	Part #	Price
2 kg - 1 mg	12074	\$3,575.00
(2) 2 kg - 1 mg*	87071	\$4,225.00
(2) 2 kg - 10 mg*	87067	\$3,900.00
2 kg - 100 mg	45982	\$3,725.00
(2) 2 kg - 100 mg*	87063	\$3,725.00
2 kg - 1 g	12077	\$3,175.00
2 kg - 1 g*	12287	\$3,175.00
(2) 2 kg - 1 g*	87075	\$3,800.00
2 kg - 100 g	45986	\$2,975.00

Optional Certificate

Accredited	Non-accredited
\$1,310.00	\$900.00
\$1,430.00	\$960.00
\$1,270.00	\$830.00
\$1,000.00	\$640.00
\$1,120.00	\$700.00
\$840.00	\$510.00
\$840.00	\$510.00
\$960.00	\$570.00
\$520.00	\$260.00

Class 4

Set Range	Part #	Price
2 kg - 1 mg	12220	\$3,200.00
(2) 2 kg - 1 mg*	87072	\$3,900.00
(2) 2 kg - 10 mg*	87068	\$3,550.00
2 kg - 100 mg	45983	\$3,700.00
(2) 2 kg - 100 mg*	87064	\$3,525.00
2 kg - 1 g	12223	\$3,050.00
2 kg - 1 g*	12390	\$3,050.00
(2) 2 kg - 1 g*	87076	\$3,300.00
2 kg - 100 g	45987	\$2,850.00

Optional Certificate

Accredited
\$640.00
\$730.00
\$640.00
\$490.00
\$540.00
\$395.00
\$395.00
\$450.00
\$210.00

* 5-2-2-1 configuration



PN 12477 Set Includes Lifting Device, Glove and Case (2kg to 1mg)

RANGE: 2 kg

ASTM
PRECISION

Weight Set Contents

5-2-2-1		5-2-2-1		5-2-2-1		5-2-2-1		5-2-2-1	
2 kg - 1mg	(2) 2 kg - 1mg	(2) 2 kg - 10 mg	2 kg - 100 mg	(2) 2 kg - 100 mg	2 kg - 1g	2 kg - 1g	(2) 2 kg - 1g	2 kg - 100g	
45915 Class 0	87043 Class 0	87042 Class 0	45916 Class 0	87041 Class 0	45917 Class 0	–	87044 Class 0	45918 Class 0	
12477 Class 1	87069 Class 1	87065 Class 1	45980 Class 1	87061 Class 1	12480 Class 1	11888 Class 1	87073 Class 1	45984 Class 1	
11926 Class 2	87070 Class 2	87066 Class 2	45981 Class 2	87062 Class 2	11929 Class 2	12148 Class 2	87074 Class 2	45985 Class 2	
12074 Class 3	87071 Class 3	87067 Class 3	45982 Class 3	87063 Class 3	12077 Class 3	12287 Class 3	87075 Class 3	45986 Class 3	
12220 Class 4	87072 Class 4	87068 Class 4	45983 Class 4	87064 Class 4	12223 Class 4	12390 Class 4	87076 Class 4	45987 Class 4	
(1) 2 kg	(2) 2 kg	(2) 2 kg	(1) 2 kg	(2) 2 kg	(1) 2 kg	(1) 2 kg	(2) 2 kg	(1) 2 kg	
(1) 1kg	(1) 1kg	(1) 1kg	(1) 1kg	(1) 1kg	(1) 1kg	(1) 1kg	(1) 1kg	(1) 1kg	
(1) 500g	(1) 500g	(1) 500g	(1) 500g	(1) 500g	(1) 500g	(1) 500g	(1) 500g	(1) 500g	
(1) 300g	–	–	(1) 300g	–	(1) 300g	–	–	(1) 300g	
(1) 200g	(2) 200g	(2) 200g	(1) 200g	(2) 200g	(1) 200g	(1) 200g	(1) 200g	(1) 200g	
(1) 100g	(1) 100g	(1) 100g	(1) 100g	(1) 100g	(1) 100g	(1) 100g	(1) 100g	(1) 100g	
(1) 50g	(1) 50g	(1) 50g	(1) 50g	(1) 50g	(1) 50g	(1) 50g	(1) 50g	(1) 100g	
(1) 30g	–	–	(1) 30g	–	(1) 30g	–	–		
(1) 20g	(2) 20g	(2) 20g	(1) 20g	(2) 20g	(1) 20g	(1) 20g	(1) 20g		
(1) 10g	(1) 10g	(1) 10g	(1) 10g	(1) 10g	(1) 10g	(1) 10g	(1) 10g		
(1) 5g	(1) 5g	(1) 5g	(1) 5g	(1) 5g	(1) 5g	(1) 5g	(1) 5g		
(1) 3g	–	–	(1) 3g	–	(1) 3g	–	–		
(1) 2g	(2) 2g	(2) 2g	(1) 2g	(2) 2g	(1) 2g	(1) 2g	(1) 2g		
(1) 1g	(1) 1g	(1) 1g	(1) 1g	(1) 1g	(1) 1g	(1) 1g	(1) 1g		
(1) 500mg	(1) 500mg	(1) 500mg	(1) 500mg	(1) 500mg					
(1) 300mg	–	–	(1) 300mg	–					
(1) 200mg	(2) 200mg	(2) 200mg	(1) 200mg	(2) 200mg					
(1) 100mg	(1) 100mg	(1) 100mg	(1) 100mg	(1) 100mg					
(1) 50mg	(1) 50mg	(1) 50mg							
(1) 30mg	–	–							
(1) 20mg	(2) 20mg	(2) 20mg							
(1) 10mg	(1) 10mg	(1) 10mg							
(1) 5mg	(1) 5mg	(1) 10mg							
(1) 3mg	–								
(1) 2mg	(2) 2mg								
(1) 1mg	(1) 1mg								
26 pcs. 4.222221kg set wt.	27 pcs. 6.222221kg set wt.	23 pcs. 6.22kg set wt.	18 pcs. 4.2221kg set wt.	19 pcs. 6.2221kg set wt.	14 pcs. 4.11kg set wt.	14 pcs. 4.11kg set wt.	15 pcs. 6.221kg set wt.	6 pcs. 4.1kg set wt.	

OIML
PRECISION

BALANCE
CALIBRATION

STAINLESS
FIELD WEIGHTS

CAST IRON
FIELD WEIGHTS

ASTM
SPECIALTY

Replacement Cases

Main Cases		
Class 0		
Set Range	Part #	Price
2 kg - 1mg	50439	\$1,850.00
(2) 2 kg - 1mg	84474	\$1,970.00
(2) 2 kg - 10 mg	84474	\$1,970.00
2 kg - 100 mg	50439	\$1,850.00
(2) 2 kg - 100 mg	84474	\$1,970.00
2 kg - 1g	50439	\$1,850.00
(2) 2 kg - 1g	84474	\$1,970.00
2 kg - 100g	50438	\$1,850.00

Main Case		
Class 1, 2 and 3		
Set Range	Part #	Price
2 kg - 1mg	11604	\$1,580.00
(2) 2 kg - 1mg	84463	\$1,590.00
(2) 2 kg - 10 mg	84463	\$1,590.00
2 kg - 100 mg	11604	\$1,580.00
(2) 2 kg - 100 mg	84463	\$1,590.00
2 kg - 1g	11604	\$1,580.00
2 kg - 1g	11583	\$1,820.00
(2) 2 kg - 1g	84463	\$1,590.00
2 kg - 100g	11604	\$1,580.00

Main Cases		
Class 4		
Set Range	Part #	Price
2 kg - 1mg	11604	\$1,580.00
(2) 2 kg - 1 mg	84463	\$1,590.00
(2) 2 kg - 10 mg	84463	\$1,590.00
2 kg - 100 mg	11604	\$1,580.00
(2) 2 kg - 100 mg	84463	\$1,590.00
2 kg - 1g	11604	\$1,580.00
2 kg - 1g	11583	\$1,820.00
(2) 2 kg - 1g	84463	\$1,590.00
2 kg - 100g	11604	\$1,580.00

Secondary Case		
Class 0		
Set Range	Part #	Price
100 g - 1mg	34697	\$225.00
100 g - 1mg	49503	\$250.00

Secondary Case		
Class 1, 2, 3 and 4		
Set Range	Part #	Price
100 g - 1mg	11588	\$180.00
100 g - 1mg	11596	\$180.00

Insert		
Wooden		
Set Range	Part #	Price
100 g	46380	\$120.00

Accessories

Description	Part #	Price
Statement of Accuracy	36092	\$47.50
Weight glove, white cotton	11714	\$6.75
Tweezer	11711	\$5.00
Premium tweezer	152414	\$43.00
Serial number	25836	\$17.00
Leaf weight cover	11755	\$43.00
Weight forceps, plastic	50035	\$43.00
Lifter bar	11747	\$21.00
Lifter bar, large handle	11712	\$73.00
Tong assembly, Class 0	50000	\$74.00
Lifter (Class 0 and OIML 2 kg and 5 kg)	50037	\$54.00

ACCESSORIES

MASS REFERENCE STANDARDS / METRIC SETS

RANGE: 3 kg and 5 kg

Class 0

Statement of Accuracy not available.

Set Range	Part #	Price
5 kg - 1 mg	45910	\$11,500.00
5 kg - 100 mg	45911	\$10,775.00
5 kg - 1 g	45912	\$9,425.00
5 kg - 100 g	45913	\$7,925.00

Certificate

Accredited
Included
Included
Included
Included

Class 1

Set Range	Part #	Price
3 kg - 1 g	11887	\$4,500.00
5 kg - 1 mg	12481	\$6,000.00
5 kg - 1 mg*	114050	\$6,000.00
5 kg - 100 mg	45988	\$5,675.00
5 kg - 1 g	12484	\$5,325.00
5 kg - 1 g*	11886	\$5,325.00
5 kg - 100 g	45992	\$4,925.00

Optional Certificate

Accredited	Non-accredited
\$960.00	\$515.00
\$1,400.00	\$840.00
\$1,400.00	\$840.00
\$1,225.00	\$765.00
\$1,075.00	\$635.00
\$1,075.00	\$635.00
\$755.00	\$400.00

Class 2

Set Range	Part #	Price
3 kg - 1 g	12147	\$3,850.00
5 kg - 1 mg	11930	\$5,325.00
5 kg - 1 mg*	114051	\$5,325.00
5 kg - 100 mg	45989	\$5,275.00
5 kg - 1 g	11933	\$4,875.00
5 kg - 1 g*	12146	\$4,875.00
5 kg - 100 g	45993	\$4,475.00

Optional Certificate

Accredited	Non-accredited
\$960.00	\$570.00
\$1,400.00	\$840.00
\$1,400.00	\$840.00
\$1,225.00	\$765.00
\$1,075.00	\$635.00
\$1,075.00	\$635.00
\$755.00	\$400.00

Class 3

Set Range	Part #	Price
3 kg - 1 g	12286	\$3,825.00
5 kg - 1 mg	12078	\$5,225.00
5 kg - 1 mg*	114052	\$5,225.00
5 kg - 100 mg	45990	\$5,075.00
5 kg - 1 g	12081	\$4,875.00
5 kg - 1 g*	12285	\$4,850.00
5 kg - 100 g	45994	\$4,450.00

Optional Certificate

Accredited	Non-accredited
\$960.00	\$570.00
\$1,400.00	\$840.00
\$1,400.00	\$840.00
\$1,225.00	\$765.00
\$1,075.00	\$635.00
\$1,075.00	\$635.00
\$755.00	\$400.00

Class 4

Set Range	Part #	Price
3 kg - 1 g	12389	\$3,425.00
5 kg - 1 mg	12224	\$4,725.00
5 kg - 1 mg*	114053	\$4,725.00
5 kg - 100 mg	45991	\$4,600.00
5 kg - 1 g	12227	\$4,200.00
5 kg - 1 g*	12388	\$4,200.00
5 kg - 100 g	45995	\$3,850.00

Optional Certificate

Accredited
\$445.00
\$780.00
\$780.00
\$590.00
\$490.00
\$490.00
\$300.00

* 5-2-2-1 configuration



PN 11887 Set Includes Lifting Device, Glove and Case (3kg to 1g)

Replacement Cases

Main Cases		
Class 0		
Set Range	Part #	Price
5 kg - 1 mg	49495	\$1,850.00
5 kg - 100 mg	49495	\$1,850.00
5 kg - 1 g	49495	\$1,850.00
5 kg - 100 g	50440	\$1,780.00

Main Case		
Class 1, 2 and 3		
Set Range	Part #	Price
3 kg - 1 g	11582	\$1,580.00
5 kg - 1 mg	11605	\$1,580.00
5 kg - 1 mg	11581	\$1,580.00
5 kg - 100 mg	11605	\$1,580.00
5 kg - 1 g	11605	\$1,580.00
5 kg - 1 g	11581	\$1,580.00
5 kg - 100 g	11605	\$1,580.00

Main Cases		
Class 4		
Set Range	Part #	Price
3 kg - 1 g	11582	\$1,580.00
5 kg - 1 mg	11605	\$1,580.00
5 kg - 1 mg	11581	\$1,580.00
5 kg - 100 mg	11605	\$1,580.00
5 kg - 1 g	11605	\$1,580.00
5 kg - 1 g	11581	\$1,580.00
5 kg - 100 g	11605	\$1,580.00

MASS REFERENCE STANDARDS / METRIC SETS
RANGE: 3 kg and 5 kg

ASTM
PRECISION

Weight Set Contents

			5-2-2-1				5-2-2-1			
3 kg - 1g		5 kg - 1mg	5 kg - 1mg		5 kg - 100 mg		5 kg - 1g		5 kg - 100 g	
–		45910 Class 0	–	45911 Class 0	45912 Class 0	–		45913 Class 0		
11887 Class 1		12481 Class 1	114050 Class 1	45988 Class 1	12484 Class 1	11886 Class 1		45992 Class 1		
12147 Class 2		11930 Class 2	114051 Class 2	45989 Class 2	11933 Class 2	12146 Class 2		45993 Class 2		
12286 Class 3		12078 Class 3	114052 Class 3	45990 Class 3	12081 Class 3	12285 Class 3		45994 Class 3		
12389 Class 4		12224 Class 4	114053 Class 4	45991 Class 4	12227 Class 4	12388 Class 4		45995 Class 4		
–	(1) 5 kg	(1) 5 kg	(1) 5 kg	(1) 5 kg	(1) 5 kg	(1) 5 kg	(1) 5 kg	(1) 5 kg		
(1) 3 kg	(1) 3 kg	–	(1) 3 kg	(1) 3 kg	(1) 3 kg	–	(1) 3 kg	(1) 3 kg		
(1) 2 kg	(1) 2 kg	(2) 2 kg	(1) 2 kg	(1) 2 kg	(1) 2 kg	(2) 2 kg	(1) 2 kg	(1) 2 kg		
(1) 1 kg	(1) 1 kg	(1) 1 kg	(1) 1 kg	(1) 1 kg	(1) 1 kg	(1) 1 kg	(1) 1 kg	(1) 1 kg		
(1) 500 g	(1) 500 g	(1) 500 g	(1) 500 g	(1) 500 g	(1) 500 g	(1) 500 g	(1) 500 g	(1) 500 g		
(1) 300 g	(1) 300 g	–	(1) 300 g	(1) 300 g	(1) 300 g	–	(1) 300 g	(1) 300 g		
(1) 200 g	(1) 200 g	(2) 200 g	(1) 200 g	(1) 200 g	(1) 200 g	(2) 200 g	(1) 200 g	(1) 200 g		
(1) 100 g	(1) 100 g	(1) 100 g	(1) 100 g	(1) 100 g	(1) 100 g	(1) 100 g	(1) 100 g	(1) 100 g		
(1) 50 g	(1) 50 g	(1) 50 g	(1) 50 g	(1) 50 g	(1) 50 g	(1) 50 g	(1) 50 g	(1) 50 g		
(1) 30 g	(1) 30 g	–	(1) 30 g	(1) 30 g	(1) 30 g	–	(1) 30 g	(1) 30 g		
(1) 20 g	(1) 20 g	(2) 20 g	(1) 20 g	(1) 20 g	(1) 20 g	(2) 20 g	(1) 20 g	(1) 20 g		
(1) 10 g	(1) 10 g	(1) 10 g	(1) 10 g	(1) 10 g	(1) 10 g	(1) 10 g	(1) 10 g	(1) 10 g		
(1) 5 g	(1) 5 g	(1) 5 g	(1) 5 g	(1) 5 g	(1) 5 g	(1) 5 g	(1) 5 g	(1) 5 g		
(1) 3 g	(1) 3 g	–	(1) 3 g	(1) 3 g	(1) 3 g	–	(1) 3 g	(1) 3 g		
(1) 2 g	(1) 2 g	(2) 2 g	(1) 2 g	(1) 2 g	(1) 2 g	(2) 2 g	(1) 2 g	(1) 2 g		
(1) 1g	(1) 1g	(1) 1g	(1) 1g	(1) 1g	(1) 1g	(1) 1g	(1) 1g	(1) 1g		
	(1) 500 mg	(1) 500 mg	(1) 500 mg	(1) 500 mg	(1) 500 mg		(1) 500 mg			
	(1) 300 mg	–	(1) 300 mg	(1) 300 mg	(1) 300 mg		(1) 300 mg			
	(1) 200 mg	(2) 200 mg	(1) 200 mg	(1) 200 mg	(1) 200 mg		(1) 200 mg			
	(1) 100 mg	(1) 100 mg	(1) 100 mg	(1) 100 mg	(1) 100 mg		(1) 100 mg			
	(1) 50 mg	(1) 50 mg	(1) 50 mg	(1) 50 mg	(1) 50 mg		(1) 50 mg			
	(1) 30 mg	–	(1) 30 mg	(1) 30 mg	(1) 30 mg		(1) 30 mg			
	(1) 20 mg	(2) 20 mg	(1) 20 mg	(1) 20 mg	(1) 20 mg		(1) 20 mg			
	(1) 10 mg	(1) 10 mg	(1) 10 mg	(1) 10 mg	(1) 10 mg		(1) 10 mg			
	(1) 5 mg	(1) 5 mg	(1) 5 mg	(1) 5 mg	(1) 5 mg		(1) 5 mg			
	(1) 3 mg	–	(1) 3 mg	(1) 3 mg	(1) 3 mg		(1) 3 mg			
	(1) 2 mg	(2) 2 mg	(1) 2 mg	(1) 2 mg	(1) 2 mg		(1) 2 mg			
	(1) 1mg	(1) 1mg	(1) 1mg	(1) 1mg	(1) 1mg		(1) 1mg			
15 pcs. 7.221kg set wt.	28 pcs. 12.222221kg set wt.	28 pcs. 12.23 kg set wt.	20 pcs. 12.22 kg set wt.	16 pcs. 12.221kg set wt.	16 pcs. 11.110 kg set wt.	8 pcs. 12.1kg set wt.				

OIML
PRECISION

BALANCE
CALIBRATION

STAINLESS
FIELD WEIGHTS

CAST IRON
FIELD WEIGHTS

ASTM
SPECIALTY

ACCESSORIES

Secondary Case		
Class 0		
Set Range	Part #	Price
100 g - 1mg	49503	\$250.00

Secondary Case		
Class 1, 2, 3 and 4		
Set Range	Part #	Price
100 g - 1mg	11588	\$180.00
100 g - 1mg	11596	\$180.00

Insert		
Wooden		
Set Range	Part #	Price
100 g	46380	\$120.00

Accessories

Description	Part #	Price
Statement of Accuracy	36092	\$47.50
Weight glove, white cotton	11714	\$6.75
Tweezer	11711	\$5.00
Premium tweezer	152414	\$43.00
Serial number	25836	\$17.00
Leaf weight cover	11755	\$43.00
Weight forceps, plastic	50035	\$43.00
Lifter bar	11747	\$21.00
Lifter bar, large handle	11712	\$73.00
Tong assembly, Class 0	50000	\$74.00
Lifter (Class 0 and OIML 2 kg and 5 kg)	50037	\$54.00

MASS REFERENCE STANDARDS / METRIC SETS

RANGE: 10 kg

Class 0

Statement of Accuracy not available.

Set Range	Part #	Price
10 kg - 1 mg	45905	\$14,975.00
10 kg - 100 mg	45906	\$14,200.00
10 kg - 1 g	45907	\$12,125.00
10 kg - 100 g	45908	\$12,025.00
10 kg - 1 kg	45909	\$9,475.00

Certificate

Accredited
Included
Included
Included
Included
Included

Class 1

Set Range	Part #	Price
10 kg - 1 mg	12485	\$8,500.00
10 kg - 100 mg	45996	\$8,375.00
10 kg - 1 g	12488	\$7,950.00
10 kg - 1 g*	11885	\$7,950.00
10 kg - 100 g	46000	\$7,875.00
10 kg - 1 kg	46004	\$6,455.00

Optional Certificate

Accredited	Non-accredited
\$1,500.00	\$900.00
\$1,325.00	\$820.00
\$1,180.00	\$690.00
\$1,180.00	\$690.00
\$870.00	\$440.00
\$530.00	\$280.00

Class 2

Set Range	Part #	Price
10 kg - 1 mg	11934	\$8,150.00
10 kg - 100 mg	45997	\$8,000.00
10 kg - 1 g	11937	\$7,925.00
10 kg - 1 g*	12144	\$7,875.00
10 kg - 100 g	46001	\$7,400.00
10 kg - 1 kg	46005	\$6,625.00

Optional Certificate

Accredited	Non-accredited
\$1,500.00	\$900.00
\$1,325.00	\$820.00
\$1,180.00	\$690.00
\$1,180.00	\$690.00
\$870.00	\$440.00
\$530.00	\$280.00

Class 3

Set Range	Part #	Price
10 kg - 1 mg	12082	\$8,075.00
10 kg - 100 mg	45998	\$7,900.00
10 kg - 1 g	12085	\$7,775.00
10 kg - 1 g*	12283	\$7,775.00
10 kg - 100 g	46002	\$7,300.00
10 kg - 1 kg	46006	\$6,550.00

Optional Certificate

Accredited	Non-accredited
\$1,500.00	\$900.00
\$1,325.00	\$820.00
\$1,180.00	\$690.00
\$1,180.00	\$690.00
\$870.00	\$440.00
\$530.00	\$280.00

Class 4

Set Range	Part #	Price
10 kg - 1 mg	12228	\$7,250.00
10 kg - 100 mg	45999	\$7,125.00
10 kg - 1 g	12231	\$7,025.00
10 kg - 1 g*	12386	\$7,025.00
10 kg - 100 g	46003	\$6,575.00
10 kg - 1 kg	46007	\$5,875.00

Optional Certificate

Accredited
\$830.00
\$640.00
\$535.00
\$535.00
\$350.00
\$250.00

* 5-2-2-1 configuration



PN 12485 Set Includes Lifting Device, Glove and Case (10 kg to 1 mg)

Replacement Cases

Main Cases		
Class 0		
Set Range	Part #	Price
10 kg - 1 mg	50442	\$2,160.00
10 kg - 100 mg	50442	\$2,160.00
10 kg - 1 g	50442	\$2,160.00
10 kg - 100 g	50442	\$2,160.00
10 kg - 1 kg	50441	\$1,820.00

Main Case		
Class 1, 2 and 3		
Set Range	Part #	Price
10 kg - 1 mg	11606	\$2,130.00
10 kg - 100 mg	11606	\$2,130.00
10 kg - 1 g	11606	\$2,130.00
10 kg - 1 g	11580	\$2,130.00
10 kg - 100 g	11606	\$2,130.00
10 kg - 1 kg	11606	\$2,130.00

Main Cases		
Class 4		
Set Range	Part #	Price
10 kg - 1 mg	11606	\$2,130.00
10 kg - 100 mg	11606	\$2,130.00
10 kg - 1 g	11606	\$2,130.00
10 kg - 1 g	11580	\$2,130.00
10 kg - 100 g	11606	\$2,130.00
10 kg - 1 kg	11606	\$2,130.00

RANGE: 10 kg

ASTM
PRECISION

Weight Set Contents

5-2-2-1

10 kg - 1mg	10 kg - 100 mg	10 kg - 1g	10 kg - 1g	10 kg - 100 g	10 kg - 1 kg
45905 Class 0 12485 Class 1 11934 Class 2 12082 Class 3 12278 Class 4	45906 Class 0 45996 Class 1 45997 Class 2 45998 Class 3 45999 Class 4	45907 Class 0 12488 Class 1 11937 Class 2 12085 Class 3 12231 Class 4	11885 Class 1 12144 Class 2 12283 Class 3 12386 Class 4 -	45908 Class 0 46000 Class 1 46001 Class 2 46002 Class 3 46003 Class 4	45909 Class 0 46004 Class 1 46005 Class 2 46006 Class 3 46007 Class 4
(1) 10 kg (1) 5 kg (1) 3 kg (1) 2 kg (1) 1 kg (1) 500 g (1) 300 g (1) 200 g (1) 100 g (1) 50 g (1) 30 g (1) 20 g (1) 10 g (1) 5 g (1) 3 g (1) 2 g (1) 1 g (1) 500 mg (1) 300 mg (1) 200 mg (1) 100 mg (1) 50 mg (1) 30 mg (1) 20 mg (1) 10 mg (1) 5 mg (1) 3 mg (1) 2 mg (1) 1 mg	(1) 10 kg (1) 5 kg (1) 3 kg (1) 2 kg (1) 1 kg (1) 500 g (1) 300 g (1) 200 g (1) 100 g (1) 50 g (1) 30 g (1) 20 g (1) 10 g (1) 5 g (1) 3 g (1) 2 g (1) 1 g (1) 500 mg (1) 300 mg (1) 200 mg (1) 100 mg	(1) 10 kg (1) 5 kg (1) 3 kg (1) 2 kg (1) 1 kg (1) 500 g (1) 300 g (1) 200 g (1) 100 g (1) 50 g (1) 30 g (1) 20 g (1) 10 g (1) 5 g (1) 3 g (1) 2 g (1) 1 g	(1) 10 kg (1) 5 kg - (2) 2 kg (1) 1 kg (1) 500 g - (2) 200 g (1) 100 g (1) 50 g - (2) 20 g (1) 10 g (1) 5 g - (2) 2 g (1) 1 g	(1) 10 kg (1) 5 kg (1) 3 kg (1) 2 kg (1) 1 kg (1) 500 g (1) 300 g (1) 200 g (1) 100 g	(1) 10 kg (1) 5 kg (1) 3 kg (1) 2 kg (1) 1 kg
29 pcs. 22.222221 kg set wt.	21 pcs. 22.2221 kg set wt.	17 pcs. 22.221 kg set wt.	17 pcs. 21.11 kg set wt.	9 pcs. 22.1 kg set wt.	5 pcs. 21 kg set wt.

OIML
PRECISION

BALANCE
CALIBRATION

STAINLESS
FIELD WEIGHTS

CAST IRON
FIELD WEIGHTS

ASTM
SPECIALTY

ACCESSORIES

Accessories

Secondary Case		
Class 0		
Set Range	Part #	Price
100 g - 1mg*	11588	\$180.00
100 g - 1 mg	49503	\$250.00
Insert, 100 g	49489	\$160.00

Secondary Case		
Class 1, 2, 3 and 4		
Set Range	Part #	Price
100 g - 1mg*	11588	\$180.00
100 g - 1 mg	11596	\$180.00
Insert, 100 g	46380	\$120.00

Description	Part #	Price
Statement of Accuracy	36092	\$47.50
Weight glove, white cotton	11714	\$6.75
Tweezer	11711	\$5.00
Premium tweezer	152414	\$43.00
Serial number	25836	\$17.00
Leaf weight cover	11755	\$43.00
Weight forceps, plastic	50035	\$43.00
Lifter bar	11747	\$21.00
Lifter bar, large handle	11712	\$73.00
Tong assembly, Class 0	50000	\$74.00
Lifter (Class 0 and OIML 2 kg and 5 kg)	50037	\$54.00

MASS REFERENCE STANDARDS / METRIC SETS

RANGE: 20 kg and 25 kg

Class 0

Statement of Accuracy not available.

Set Range	Part #	Price
20 kg - 1 mg	45900	\$18,950.00
20 kg - 100 mg	45901	\$18,225.00
20 kg - 1 g	45902	\$16,125.00
20 kg - 100 g	45903	\$16,025.00
20 kg - 1 kg	45904	\$13,925.00

Certificate

Accredited
Included
Included
Included
Included
Included

Class 1

Set Range	Part #	Price
25 kg - 1 g*	11883	\$15,950.00
20 kg - 1 mg	12489	\$11,700.00
20 kg - 100 mg	46008	\$11,575.00
20 kg - 1 g	12492	\$10,850.00
20 kg - 1 g*	11884	\$10,850.00
20 kg - 100 g	46012	\$10,250.00
20 kg - 1 kg	46016	\$10,050.00

Optional Certificate

Accredited	Non-accredited
\$1,395.00	\$815.00
\$1,680.00	\$1,025.00
\$1,445.00	\$885.00
\$1,285.00	\$760.00
\$1,285.00	\$760.00
\$975.00	\$500.00
\$645.00	\$340.00

Class 2

Set Range	Part #	Price
25 kg - 1 g*	12140	\$14,375.00
20 kg - 1 mg	11938	\$10,625.00
20 kg - 100 mg	46009	\$10,450.00
20 kg - 1 g	11941	\$10,350.00
20 kg - 1 g*	12142	\$10,350.00
20 kg - 100 g	46013	\$9,850.00
20 kg - 1 kg	46017	\$9,075.00

Optional Certificate

Accredited	Non-accredited
\$1,395.00	\$815.00
\$1,680.00	\$1,025.00
\$1,445.00	\$885.00
\$1,285.00	\$760.00
\$1,285.00	\$760.00
\$975.00	\$500.00
\$645.00	\$340.00

Class 3

Set Range	Part #	Price
25 kg - 1 g*	12279	\$13,825.00
20 kg - 1 mg	12086	\$10,525.00
20 kg - 100 mg	46010	\$10,350.00
20 kg - 1 g	12089	\$10,225.00
20 kg - 1 g*	12281	\$10,225.00
20 kg - 100 g	46014	\$9,725.00
20 kg - 1 kg	46018	\$8,775.00

Optional Certificate

Accredited	Non-accredited
\$1,395.00	\$815.00
\$1,680.00	\$1,025.00
\$1,445.00	\$885.00
\$1,285.00	\$760.00
\$1,285.00	\$760.00
\$975.00	\$500.00
\$645.00	\$340.00

Class 4

Set Range	Part #	Price
25 kg - 1 g*	12382	\$12,925.00
20 kg - 1 mg	12232	\$9,475.00
20 kg - 100 mg	46011	\$9,300.00
20 kg - 1 g	12235	\$9,225.00
20 kg - 1 g*	12384	\$9,225.00
20 kg - 100 g	46015	\$8,775.00
20 kg - 1 kg	46019	\$8,075.00

Optional Certificate

Accredited
\$590.00
\$900.00
\$680.00
\$610.00
\$610.00
\$395.00
\$270.00

* 5-2-2-1 configuration

Replacement Cases

Main Cases		
Class 0		
Set Range	Part #	Price
20 kg - 1 mg	50670	\$2,160.00
20 kg - 100 mg	50670	\$2,160.00
20 kg - 1 g	50670	\$2,160.00
20 kg - 100 g	50670	\$2,160.00
20 kg - 1 kg	50670	\$2,160.00

Main Case		
Class 1, 2 and 3		
Set Range	Part #	Price
25 kg - 1 g*	11578	\$2,130.00
20 kg - 1 mg	11608	\$2,130.00
20 kg - 100 mg	11608	\$2,130.00
20 kg - 1 g	11608	\$2,130.00
20 kg - 1 g*	11579	\$2,080.00
20 kg - 100 g	11608	\$2,130.00
20 kg - 1 kg	11608	\$2,130.00

Main Cases		
Class 4		
Set Range	Part #	Price
25 kg - 1 g*	11578	\$2,130.00
20 kg - 1 mg	11608	\$2,130.00
20 kg - 100 mg	11608	\$2,130.00
20 kg - 1 g	11579	\$2,080.00
20 kg - 1 g*	11608	\$2,130.00
20 kg - 100 g	11608	\$2,130.00
20 kg - 1 kg	11608	\$2,130.00

MASS REFERENCE STANDARDS / METRIC SETS

RANGE: 20 kg and 25 kg

ASTM
PRECISION

Weight Set Contents

5-2-2-1			5-2-2-1				
25 kg - 1g		20 kg - 1mg	20 kg - 100 mg	20 kg - 1g	20 kg - 1g	20 kg - 100 g	20 - 1kg
–		45900 Class 0	45901 Class 0	45902 Class 0	–	45903 Class 0	45904 Class 0
11883 Class 1		12489 Class 1	46008 Class 1	12492 Class 1	11884 Class 1	46012 Class 1	46016 Class 1
12140 Class 2		11938 Class 2	46009 Class 2	11941 Class 2	12142 Class 2	46013 Class 2	46017 Class 2
12279 Class 3		12086 Class 3	46010 Class 3	12089 Class 3	12281 Class 3	46014 Class 3	46018 Class 3
12382 Class 4		12232 Class 4	46011 Class 4	12235 Class 4	12384 Class 4	46015 Class 4	46019 Class 4
(1) 25 kg	–	–	–	–	–	–	–
–	(1) 20 kg	(1) 20 kg	(1) 20 kg	(1) 20 kg	(1) 20 kg	(1) 20 kg	(1) 20 kg
(1) 10 kg	(1) 10 kg	(1) 10 kg	(1) 10 kg	(1) 10 kg	(1) 10 kg	(1) 10 kg	(1) 10 kg
(1) 5 kg	(1) 5 kg	(1) 5 kg	(1) 5 kg	(1) 5 kg	(1) 5 kg	(1) 5 kg	(1) 5 kg
–	(1) 3 kg	(1) 3 kg	(1) 3 kg	(1) 3 kg	–	(1) 3 kg	(1) 3 kg
(2) 2 kg	(1) 2 kg	(1) 2 kg	(1) 2 kg	(1) 2 kg	(2) 2 kg	(1) 2 kg	(1) 2 kg
(1) 1 kg	(1) 1 kg	(1) 1 kg	(1) 1 kg	(1) 1 kg	(1) 1 kg	(1) 1 kg	(1) 1 kg
(1) 500 g	(1) 500 g	(1) 500 g	(1) 500 g	(1) 500 g	(1) 500 g	(1) 500 g	
–	(1) 300 g	(1) 300 g	(1) 300 g	(1) 300 g	–	(1) 300 g	
(2) 200 g	(1) 200 g	(1) 200 g	(1) 200 g	(1) 200 g	(2) 200 g	(1) 200 g	
(1) 100 g	(1) 100 g	(1) 100 g	(1) 100 g	(1) 100 g	(1) 100 g	(1) 100 g	
(1) 50 g	(1) 50 g	(1) 50 g	(1) 50 g	(1) 50 g	(1) 50 g		
–	(1) 30 g	(1) 30 g	(1) 30 g	(1) 30 g	–		
(2) 20 g	(1) 20 g	(1) 20 g	(1) 20 g	(1) 20 g	(2) 20 g		
(1) 10 g	(1) 10 g	(1) 10 g	(1) 10 g	(1) 10 g	(1) 10 g		
(1) 5 g	(1) 5 g	(1) 5 g	(1) 5 g	(1) 5 g	(1) 5 g		
–	(1) 3 g	(1) 3 g	(1) 3 g	(1) 3 g	–		
(2) 2 g	(1) 2 g	(1) 2 g	(1) 2 g	(1) 2 g	(2) 2 g		
(1) 1 g	(1) 1 g	(1) 1 g	(1) 1 g	(1) 1 g	(1) 1 g		
	(1) 500 mg	(1) 500 mg					
	(1) 300 mg	(1) 300 mg					
	(1) 200 mg	(1) 200 mg					
	(1) 100 mg	(1) 100 mg					
	(1) 50 mg						
	(1) 30 mg						
	(1) 20 mg						
	(1) 10 mg						
	(1) 5 mg						
	(1) 3 mg						
	(1) 2 mg						
	(1) 1 mg						
18 pcs. 46.11kg set wt.	30 pcs. 42.222221kg set wt.	22 pcs. 42.22kg set wt.	18 pcs. 42.22 kg set wt.	18 pcs. 41.11kg set wt.	10 pcs. 42.1kg set wt.	6 pcs. 41kg set wt.	

OIML
PRECISION

BALANCE
CALIBRATION

STAINLESS
FIELD WEIGHTS

CAST IRON
FIELD WEIGHTS

ASTM
SPECIALTY

ACCESSORIES

Accessories

Secondary Case		
Class 0		
Set Range	Part #	Price
100 g - 1mg*	11588	\$180.00
100 g - 1mg	49503	\$250.00
Insert, 100 g	49489	\$160.00

Secondary Case		
Class 1, 2, 3 and 4		
Set Range	Part #	Price
100 g - 1mg*	11588	\$180.00
100 g - 1mg	11596	\$180.00
Insert, 100 g	46380	\$120.00

Description	Part #	Price
Statement of Accuracy	36092	\$47.50
Weight glove, white cotton	11714	\$6.75
Tweezer	11711	\$5.00
Premium tweezer	152414	\$43.00
Serial number	25836	\$17.00
Leaf weight cover	11755	\$43.00
Weight forceps, plastic	50035	\$43.00
Lifter bar	11747	\$21.00
Lifter bar, large handle	11712	\$73.00
Tong assembly, Class 0	50000	\$74.00
Lifter (Class 0 and OIML 2 kg and 5 kg)	50037	\$54.00

* 5-2-2-1 configuration

MASS REFERENCE STANDARDS / METRIC SETS

RANGE: 2 lb through 50 lb

Class 1

Set Range	Part #	Price
50 lb - 1/32 oz	11999	\$20,825.00
50 lb - 0.001lb	119043	\$20,825.00
20 lb - 1/32 oz	11997	\$9,975.00
20 lb - 0.001lb	119047	\$9,975.00
10 lb - 1/32 oz	11995	\$6,975.00
10 lb - 0.001lb	119051	\$6,975.00
5 lb - 1/32 oz	11993	\$5,325.00
5 lb - 0.001lb	119055	\$5,325.00
2 lb - 1/32 oz	11991	\$3,550.00
2 lb - 0.001lb	119059	\$3,550.00

Optional Certificate

Accredited	Non-accredited
\$1,260.00	\$800.00
\$1,260.00	\$800.00
\$950.00	\$670.00
\$950.00	\$670.00
\$830.00	\$600.00
\$830.00	\$600.00
\$725.00	\$530.00
\$725.00	\$530.00
\$545.00	\$415.00
\$545.00	\$415.00

Class 2

Set Range	Part #	Price
50 lb - 1/32 oz	12145	\$20,600.00
50 lb - 0.001lb	119044	\$20,600.00
20 lb - 1/32 oz	12143	\$9,975.00
20 lb - 0.001lb	119048	\$9,975.00
10 lb - 1/32 oz	12141	\$6,975.00
10 lb - 0.001lb	119052	\$6,775.00
5 lb - 1/32 oz	12139	\$5,125.00
5 lb - 0.001lb	119056	\$5,125.00
2 lb - 1/32 oz	12137	\$3,400.00
2 lb - 0.001lb	119060	\$3,400.00

Optional Certificate

Accredited	Non-accredited
\$1,260.00	\$800.00
\$1,260.00	\$800.00
\$950.00	\$670.00
\$950.00	\$670.00
\$830.00	\$600.00
\$830.00	\$600.00
\$725.00	\$530.00
\$725.00	\$530.00
\$545.00	\$415.00
\$545.00	\$415.00

Class 3

Set Range	Part #	Price
50 lb - 1/32 oz	12284	\$20,325.00
50 lb - 0.001lb	119045	\$20,325.00
20 lb - 1/32 oz	12282	\$9,750.00
20 lb - 0.001lb	119049	\$9,950.00
10 lb - 1/32 oz	12280	\$6,675.00
10 lb - 0.001lb	119053	\$6,675.00
5 lb - 1/32 oz	12278	\$5,075.00
5 lb - 0.001lb	119057	\$5,075.00
2 lb - 1/32 oz	12276	\$3,225.00
2 lb - 0.001lb	119061	\$3,225.00

Optional Certificate

Accredited	Non-accredited
\$1,260.00	\$800.00
\$1,260.00	\$800.00
\$950.00	\$670.00
\$950.00	\$670.00
\$830.00	\$600.00
\$830.00	\$600.00
\$725.00	\$530.00
\$725.00	\$530.00
\$545.00	\$415.00
\$545.00	\$415.00

Class 4

Set Range	Part #	Price
50 lb - 1/32 oz	12387	\$19,825.00
50 lb - 0.001lb	119046	\$19,825.00
20 lb - 1/32 oz	12385	\$9,150.00
20 lb - 0.001lb	119050	\$9,150.00
10 lb - 1/32 oz	12383	\$6,575.00
10 lb - 0.001lb	119054	\$6,575.00
5 lb - 1/32 oz	12381	\$4,575.00
5 lb - 0.001lb	119058	\$4,575.00
2 lb - 1/32 oz	12379	\$2,975.00
2 lb - 0.001lb	119062	\$2,975.00

Optional Certificate

Accredited
\$605.00
\$605.00
\$500.00
\$500.00
\$465.00
\$465.00
\$410.00
\$410.00
\$325.00
\$325.00



PN 11995 Set Includes Lifting Device, Glove and Case (10 lb to 1/32 oz)

Weight Set Contents

50 lb - 1/32 oz	50 lb - 0.001lb	20 lb - 1/32 oz	20 lb - 0.001lb	10 lb - 1/32 oz	10 lb - 0.001lb	5 lb - 1/32 oz	5 lb - 0.001lb	2 lb - 1/32 oz	2 lb - 0.001lb
11999 Class 1	119043 Class 1	11997 Class 1	119047 Class 1	11995 Class 1	119051 Class 1	11993 Class 1	119055 Class 1	11991 Class 1	119059 Class 1
12145 Class 2	119044 Class 2	12143 Class 2	119048 Class 2	12141 Class 2	119052 Class 2	12139 Class 2	119056 Class 2	12137 Class 2	119060 Class 2
12284 Class 3	119045 Class 3	12282 Class 3	119049 Class 3	12280 Class 3	119053 Class 3	12278 Class 3	119057 Class 3	12276 Class 3	119061 Class 3
12387 Class 4	119046 Class 4	12385 Class 4	119050 Class 4	12383 Class 4	119054 Class 4	12381 Class 4	119058 Class 4	12379 Class 4	119062 Class 4
(1) 50 lb	(1) 50 lb	—	—	—	—	—	—	—	—
(1) 30 lb	(1) 30 lb	—	—	—	—	—	—	—	—
(1) 20 lb	(1) 20 lb	(1) 20 lb	(1) 20 lb	—	—	—	—	—	—
(1) 10 lb	(1) 10 lb	(1) 10 lb	(1) 10 lb	(1) 10 lb	(1) 10 lb	—	—	—	—
(1) 5 lb	(1) 5 lb	(1) 5 lb	(1) 5 lb	(1) 5 lb	(1) 5 lb	(1) 5 lb	(1) 5 lb	—	—
(1) 3 lb	(1) 3 lb	(1) 3 lb	(1) 3 lb	(1) 3 lb	(1) 3 lb	(1) 3 lb	(1) 3 lb	—	—
(1) 2 lb	(1) 2 lb	(1) 2 lb	(1) 2 lb	(1) 2 lb	(1) 2 lb	(1) 2 lb	(1) 2 lb	(1) 2 lb	(1) 2 lb
(1) 1 lb	(1) 1 lb	(1) 1 lb	(1) 1 lb	(1) 1 lb	(1) 1 lb	(1) 1 lb	(1) 1 lb	(1) 1 lb	(1) 1 lb
(1) 8 oz	(1) 0.5 lb	(1) 8 oz	(1) 0.5 lb	(1) 8 oz	(1) 0.5 lb	(1) 8 oz	(1) 0.5 lb	(1) 8 oz	(1) 0.5 lb
(1) 4 oz	(1) 0.3 lb	(1) 4 oz	(1) 0.3 lb	(1) 4 oz	(1) 0.3 lb	(1) 4 oz	(1) 0.3 lb	(1) 4 oz	(1) 0.3 lb
(1) 2 oz	(1) 0.2 lb	(1) 2 oz	(1) 0.2 lb	(1) 2 oz	(1) 0.2 lb	(1) 2 oz	(1) 0.2 lb	(1) 2 oz	(1) 0.2 lb
(1) 1 oz	(1) 0.1 lb	(1) 1 oz	(1) 0.1 lb	(1) 1 oz	(1) 0.1 lb	(1) 1 oz	(1) 0.1 lb	(1) 1 oz	(1) 0.1 lb
(1) 1/2 oz	(1) 0.05 lb	(1) 1/2 oz	(1) 0.05 lb	(1) 1/2 oz	(1) 0.05 lb	(1) 1/2 oz	(1) 0.05 lb	(1) 1/2 oz	(1) 0.05 lb
(1) 1/4 oz	(1) 0.03 lb	(1) 1/4 oz	(1) 0.03 lb	(1) 1/4 oz	(1) 0.03 lb	(1) 1/4 oz	(1) 0.03 lb	(1) 1/4 oz	(1) 0.03 lb
(1) 1/8 oz	(1) 0.02 lb	(1) 1/8 oz	(1) 0.02 lb	(1) 1/8 oz	(1) 0.02 lb	(1) 1/8 oz	(1) 0.02 lb	(1) 1/8 oz	(1) 0.02 lb
(1) 1/16 oz	(1) 0.01 lb	(1) 1/16 oz	(1) 0.01 lb	(1) 1/16 oz	(1) 0.01 lb	(1) 1/16 oz	(1) 0.01 lb	(1) 1/16 oz	(1) 0.01 lb
(2) 1/32 oz	(1) 0.005 lb	(2) 1/32 oz	(1) 0.005 lb	(2) 1/32 oz	(1) 0.005 lb	(2) 1/32 oz	(1) 0.005 lb	(2) 1/32 oz	(1) 0.005 lb
	(1) 0.003 lb		(1) 0.003 lb		(1) 0.003 lb		(1) 0.003 lb		(1) 0.003 lb
	(1) 0.002 lb		(1) 0.002 lb		(1) 0.002 lb		(1) 0.002 lb		(1) 0.002 lb
	(1) 0.001 lb		(1) 0.001 lb		(1) 0.001 lb		(1) 0.001 lb		(1) 0.001 lb
18 pcs. 122 lb set wt.	20 pcs. 122 lb set wt.	16 pcs. 42 lb set wt.	18 pcs. 42 lb set wt.	15 pcs. 22 lb set wt.	17 pcs. 22 lb set wt.	14 pcs. 12 lb set wt.	16 pcs. 12 lb set wt.	12 pcs. 4 lb set wt.	14 pcs. 4 lb set wt.

Replacement Cases

Main Cases		
Class 1, 2 and 3		
Set Range	Part #	Price
50 lb - 1/32 oz	11589	\$2,130.00
50 lb - 0.001lb	11589	\$2,130.00
20 lb - 1/32 oz	11590	\$2,280.00
20 lb - 0.001lb	11590	\$2,280.00
10 lb - 1/32 oz	11591	\$1,820.00
10 lb - 0.001lb	11591	\$1,820.00
5 lb - 1/32 oz	11592	\$1,410.00
5 lb - 0.001lb	11592	\$1,410.00
2 lb - 1/32 oz	11593	\$1,840.00
2 lb - 0.001lb	11593	\$1,840.00

Main Cases		
Class 4		
Set Range	Part #	Price
50 lb - 1/32 oz	11589	\$2,130.00
50 lb - 0.001lb	11589	\$2,130.00
20 lb - 1/32 oz	11590	\$2,280.00
20 lb - 0.001lb	11590	\$2,280.00
10 lb - 1/32 oz	11591	\$1,820.00
10 lb - 0.001lb	11591	\$1,820.00
5 lb - 1/32 oz	11592	\$1,410.00
5 lb - 0.001lb	11592	\$1,410.00
2 lb - 1/32 oz	11593	\$1,840.00
2 lb - 0.001lb	11593	\$1,840.00

Secondary Case		
Class 1, 2, 3 and 4		
Set Range	Part #	Price
4 oz - 1/32 oz	11610	\$310.00
0.3 lb to 0.001 lb	118813	\$295.00

Accessories

Description	Part #	Price
Statement of Accuracy	36092	\$47.50
Weight glove, white cotton	11714	\$6.75
Tweezer	11711	\$5.00
Premium tweezer	152414	\$43.00
Serial number	25836	\$17.00
Leaf weight cover	11755	\$43.00
Weight forceps, plastic	50035	\$43.00
Lifter bar	11747	\$21.00
Lifter bar, large handle	11712	\$73.00
Tong assembly, Class 0	50000	\$74.00
Lifter (Class 0 and OIML 2 kg and 5 kg)	50037	\$54.00

OIML

Mass Reference Standards

Applications:

Density measurement

Tolerance checking

Mass standards

OIML guidelines for balance
and scale verification

Designs Available:

Type I (one piece design) for Class E1, E2

Type II (with sealing cavity) for Class F1, F2, M1, M2

Product Configuration:

Single weight

Single weight kit: weight, case or vial, and glove

Weight set: weights, case (additional small case or vial if required) and handling equipment

Weight set configuration: 5-2-2-1 Example: (1) 50 g, (2) 20 g and (1) 10 g

OIML weight sets larger than 500 g include a hardwood case with velvet-lined pockets

Weight sets with the largest weight of 500 g include a precision-machined, polyvinyl, crush-resistant case

Features:

Serial numbers applied to case (weights may be marked with symbol)

Density for E1/E2 are 7.95 g/cm³

Density for F1/F2/M1/M2 are 7.84 g/cm³ (unless otherwise noted)

OIML E1, E2, F1 and F2 polish finish

OIML M1 and M2 satin finish

E1, E2, F1, F2 and M1 weights include protective case

Weights manufactured to International Recommendation, OIML R111 specifications

E1 and E2 supplied with Accredited Certificate per OIML R111



Metric Single Weight with Case (Kits)

- 62** Range: 10 kg – 1g
- 63** Range: 500 mg – 1mg

Metric Single Weights

- 64** Range: 20 kg – 1mg

Metric Sets

- 65** Range: 500 mg – 50 g
- 66** Range: 100 g
- 68** Range: 200 g
- 70** Range: 500 g
- 72** Range: 1 kg
- 74** Range: 2 kg
- 76** Range: 5 kg
- 78** Range: 10 kg
- 80** Range: 20 kg

MASS REFERENCE STANDARDS / METRIC SINGLE WEIGHT WITH CASE (KITS)

RANGE: 10 kg – 1 g

Class E1 Polished Finish

Statement of Accuracy not available.

Weight	Part #	Price	Certificate Accredited
10 kg	36872	\$3,625.00	Included
5 kg	29785	\$2,400.00	Included
2 kg	29784	\$1,720.00	Included
1 kg	29783	\$1,160.00	Included
500 g	29782	\$860.00	Included
200 g	29781	\$740.00	Included
100 g	29780	\$690.00	Included
50 g	29779	\$615.00	Included
20 g	29778	\$610.00	Included
10 g	29777	\$605.00	Included
5 g	29776	\$545.00	Included
2 g	29745	\$545.00	Included
1 g	29744	\$520.00	Included

Class E2 Polished Finish

Statement of Accuracy not available.

Weight	Part #	Price	Certificate Accredited
20 kg	53850	\$3,250.00	Included
10 kg	36871	\$2,675.00	Included
5 kg	29775	\$1,500.00	Included
2 kg	29774	\$945.00	Included
1 kg	29773	\$705.00	Included
500 g	29772	\$490.00	Included
200 g	29771	\$390.00	Included
100 g	29770	\$190.00	Included
50 g	29769	\$185.00	Included
20 g	29768	\$185.00	Included
10 g	29767	\$175.00	Included
5 g	29766	\$150.00	Included
2 g	29743	\$150.00	Included
1 g	29742	\$150.00	Included

Class F1 Polished Finish

Weight	Part #	Price	Optional Certificate	
			Accredited	Non-accredited
20 kg	53654	\$2,400.00	\$145.00	\$80.00
10 kg	36870	\$1,940.00	\$145.00	\$80.00
5 kg	29765	\$1,170.00	\$145.00	\$80.00
2 kg	29764	\$685.00	\$145.00	\$80.00
1 kg	29763	\$485.00	\$125.00	\$60.00
500 g	29762	\$280.00	\$125.00	\$60.00
200 g	29761	\$220.00	\$125.00	\$60.00
100 g	29760	\$155.00	\$55.00	\$45.00
50 g	29759	\$135.00	\$55.00	\$45.00
20 g	29758	\$135.00	\$55.00	\$45.00
10 g	29757	\$135.00	\$55.00	\$45.00
5 g	29756	\$135.00	\$55.00	\$45.00
2 g	29741	\$135.00	\$55.00	\$45.00
1 g	29740	\$135.00	\$55.00	\$45.00

Class F2 Polished Finish

Weight	Part #	Price	Optional Certificate	
			Accredited	Non-accredited
20 kg	53655	\$2,290.00	\$145.00	\$80.00
10 kg	36869	\$1,500.00	\$145.00	\$80.00
5 kg	29755	\$815.00	\$145.00	\$80.00
2 kg	29754	\$645.00	\$145.00	\$80.00
1 kg	29753	\$415.00	\$125.00	\$60.00
500 g	29752	\$280.00	\$125.00	\$60.00
200 g	29751	\$215.00	\$125.00	\$60.00
100 g	29750	\$130.00	\$55.00	\$45.00
50 g	29749	\$130.00	\$55.00	\$45.00
20 g	29748	\$130.00	\$55.00	\$45.00
10 g	29747	\$93.00	\$55.00	\$45.00
5 g	29746	\$130.00	\$55.00	\$45.00
2 g	29739	\$130.00	\$55.00	\$45.00
1 g	29738	\$130.00	\$55.00	\$45.00



PN 29780 Kits Include Glove with Cased Weight

Accessories

Description	Part #	Price
Statement of Accuracy	36092	\$47.50
Weight glove, white cotton	11714	\$6.75
Premium tweezers	152414	\$43.00

MASS REFERENCE STANDARDS / METRIC SINGLE WEIGHT WITH CASE (KITS)

RANGE: 500 mg – 1 mg

Class E1 Polished Finish
Statement of Accuracy not available.

Weight	Part #	Price
500 mg	29737	\$295.00
200 mg	29736	\$295.00
100 mg	29735	\$295.00
50 mg	29734	\$295.00
20 mg	29733	\$295.00
10 mg	29732	\$295.00
5 mg	29713	\$295.00
2 mg	29712	\$295.00
1 mg	29711	\$295.00

Certificate

Accredited
Included
Included
Included
Included
Included
Included
Included
Included
Included
Included

Class F2 Polished Finish

Weight	Part #	Price
500 mg	29719	\$48.50
200 mg	29718	\$48.50
100 mg	29717	\$48.50
50 mg	29716	\$48.50
20 mg	29715	\$48.50
10 mg	29714	\$48.50
5 mg	29704	\$48.50
2 mg	29703	\$48.50
1 mg	29702	\$48.50

Optional Certificate

Accredited	Accredited
\$55.00	\$45.00
\$55.00	\$45.00
\$55.00	\$45.00
\$55.00	\$45.00
\$55.00	\$45.00
\$55.00	\$45.00
\$55.00	\$45.00
\$55.00	\$45.00
\$55.00	\$45.00
\$55.00	\$45.00

Class E2 Polished Finish
Statement of Accuracy not available.

Weight	Part #	Price
500 mg	29731	\$150.00
200 mg	29730	\$150.00
100 mg	29729	\$150.00
50 mg	29728	\$150.00
20 mg	29727	\$150.00
10 mg	29726	\$150.00
5 mg	29710	\$150.00
2 mg	29709	\$150.00
1 mg	29708	\$150.00

Certificate

Accredited
Included
Included
Included
Included
Included
Included
Included
Included
Included

Class F1 Polished Finish

Weight	Part #	Price
500 mg	29725	\$54.00
200 mg	29724	\$54.00
100 mg	29723	\$54.00
50 mg	29722	\$54.00
20 mg	29721	\$54.00
10 mg	29720	\$54.00
5 mg	29707	\$54.00
2 mg	29706	\$54.00
1 mg	29705	\$54.00

Optional Certificate

Accredited	Non-Accredited
\$55.00	\$45.00
\$55.00	\$45.00
\$55.00	\$45.00
\$55.00	\$45.00
\$55.00	\$45.00
\$55.00	\$45.00
\$55.00	\$45.00
\$55.00	\$45.00
\$55.00	\$45.00



Accessories

Description	Part #	Price
Statement of Accuracy	36092	\$47.50
Weight glove, white cotton	11714	\$6.75
Premium tweezer	152414	\$43.00
Vial for mg weights	50038	\$5.00

ASTM
PRECISION

OIML
PRECISION

BALANCE
CALIBRATION

STAINLESS
FIELD WEIGHTS

CAST IRON
FIELD WEIGHTS

ASTM
SPECIALTY

ACCESSORIES

MASS REFERENCE STANDARDS / METRIC SINGLE WEIGHTS

RANGE: 20 kg – 1 mg

ASTM
PRECISION

OIML
PRECISION

BALANCE
CALIBRATION

STAINLESS
FIELD WEIGHTS

CAST IRON
FIELD WEIGHTS

ASTM
SPECIALTY

ACCESSORIES

Class M1 Satin Finish

Weight	Part #	Price	Accredited
20 kg	156292	\$1,450.00	\$75.00
10 kg	156291	\$1,240.00	\$75.00
5 kg	116207	\$565.00	\$75.00
2 kg	116206	\$320.00	\$75.00
1 kg	116205	\$225.00	\$55.00
500 g	116204	\$130.00	\$55.00
200 g	116203	\$115.00	\$55.00
100 g	111927	\$87.00	\$40.00
50 g	111928	\$82.00	\$40.00
20 g	111929	\$79.00	\$40.00
10 g	111930	\$79.00	\$40.00
5 g	111931	\$73.00	\$40.00
2 g	111932	\$73.00	\$40.00
1 g	111933	\$73.00	\$40.00
500 mg	202833	\$24.25	\$40.00
200 mg	202835	\$24.25	\$40.00
100 mg	202836	\$24.25	\$40.00
50 mg	202837	\$24.25	\$40.00
20 mg	202838	\$24.25	\$40.00
10 mg	202839	\$24.25	\$40.00
5 mg	202840	\$24.25	\$40.00
2 mg	202841	\$24.25	\$40.00
1 mg	202842	\$24.25	\$40.00

Optional Certificate

Class M2 Satin Finish

M2 is sold as a single weight, accessory cases are available.

Weight	Part #	Price	Accredited
5 kg	115926	\$240.00	\$75.00
2 kg	115925	\$150.00	\$75.00
1 kg	115924	\$81.00	\$55.00
500 g	115923	\$75.00	\$55.00
200 g	115922	\$59.00	\$55.00
100 g	111934	\$51.00	\$40.00
50 g	111935	\$46.50	\$40.00
20 g	111936	\$41.00	\$40.00
10 g	111937	\$41.00	\$40.00
5 g	111938	\$37.50	\$40.00
2 g	111939	\$37.50	\$40.00
1 g	111940	\$37.50	\$40.00

Optional Certificate

Replacement Cases

Main Cases		
Class M1		
Nominal Value	Part #	Price
20 kg	156290	\$560.00
10 kg	156289	\$560.00
5 kg	Consult	Consult
2 kg	190266	\$38.50
1 kg	190262	\$38.50
500 g	189711	\$38.50
200 g	196466	\$37.50
100 g	189566	\$42.00
50 g	189487	\$42.00
20 g	189477	\$42.00
10 g	189351	\$42.00
5 g	189240	\$42.00
2 g	189236	\$42.00
1 g	188285	\$42.00
500 mg	50038	\$5.00
200 mg	50038	\$5.00
100 mg	50038	\$5.00
50 mg	50038	\$5.00
20 mg	50038	\$5.00
10 mg	50038	\$5.00
5 mg	50038	\$5.00
2 mg	50038	\$5.00
1 mg	50038	\$5.00

Replacement Cases

Main Cases		
Class M2		
Nominal Value	Part #	Price
5 kg	Consult	Consult
2 kg	190266	\$38.50
1 kg	190262	\$38.50
500 g	189711	\$38.50
200 g	196466	\$37.50
100 g	189566	\$42.00
50 g	189487	\$42.00
20 g	189477	\$42.00
10 g	189351	\$42.00
5 g	189240	\$42.00
2 g	189236	\$42.00
1 g	188285	\$42.00

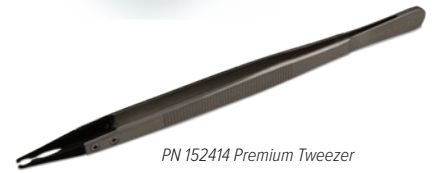

PN 152414 Premium Tweezer

Accessories

Description	Part #	Price
Statement of Accuracy	36092	\$47.50
Weight glove, white cotton	11714	\$6.75
Premium tweezer	152414	\$43.00

MASS REFERENCE STANDARDS / METRIC SETS

RANGE: 500 mg – 50 g

Class E1 Polished Finish

Statement of Accuracy not available.

Set Range	Part #	Price
500 mg - 1 mg	30850	\$2,170.00
500 mg - 100 mg	30854	\$1,100.00

Certificate

Accredited
Included
Included

Class E2 Polished Finish

Statement of Accuracy not available.

Set Range	Part #	Price
500 mg - 1 mg	30851	\$1,480.00
500 mg - 100 mg	30855	\$940.00
50 g - 1 mg	96477	\$2,210.00
50 g - 1g	96478	\$1,210.00

Certificate

Accredited
Included
Included
Included
Included

Class F1 Polished Finish

Set Range	Part #	Price
500 mg - 1 mg	30852	\$615.00
500 mg - 100 mg	30856	\$450.00
50 g - 1 mg	96479	\$1,200.00
50 g - 1g	96480	\$730.00

Optional Certificate

Accredited	Non-accredited
\$470.00	\$375.00
\$155.00	\$125.00
\$790.00	\$630.00
\$310.00	\$250.00

Class F2 Polished Finish

Set Range	Part #	Price
500 mg - 1 mg	30853	\$610.00
500 mg - 100 mg	30857	\$345.00
50 g - 1 mg	96481	\$980.00
50 g - 1g	96482	\$715.00

Optional Certificate

Accredited	Non-accredited
\$470.00	\$375.00
\$155.00	\$125.00
\$790.00	\$630.00
\$310.00	\$250.00

Class M1 Satin Finish

Set Range	Part #	Price
500 mg - 1 mg	161537	\$450.00

Optional Certificate

Accredited
\$280.00

Weight Set Contents

500 mg - 1 mg	500 mg - 100 mg	50 g - 1 mg	50 g - 1g
30850 Class E1	30854 Class E1	–	–
30851 Class E2	30855 Class E2	96477 Class E2	96478 Class E2
30852 Class F1	30856 Class F1	96479 Class F1	96480 Class F1
30853 Class F2	30857 Class F2	96481 Class F2	96482 Class F2
161537 Class M1	–	–	–
–	–	(1) 50 g	(1) 50 g
–	–	(2) 20 g	(2) 20 g
–	–	(1) 10 g	(1) 10 g
–	–	(1) 5 g	(1) 5 g
–	–	(2) 2 g	(2) 2 g
–	–	(1) 1 g	(1) 1 g
(1) 500 mg	(1) 500 mg	(1) 500 mg	
(2) 200 mg	(2) 200 mg	(2) 200 mg	
(1) 100 mg	(1) 100 mg	(1) 100 mg	
(1) 50 mg		(1) 50 mg	
(2) 20 mg		(2) 20 mg	
(1) 10 mg		(1) 10 mg	
(1) 5 mg		(1) 5 mg	
(2) 2 mg		(2) 2 mg	
(1) 1 mg		(1) 1 mg	
12 pcs. 1.11g set wt.	4 pcs. 1g set wt.	20 pcs. 111.11g set wt.	8 pcs. 108g set wt.



Set Includes Lifting Device, Glove and Case

Replacement Cases

Main Cases		
Class E1		
Set Range	Part #	Price
500 mg - 1 mg	34699	\$125.00
500 mg - 100 mg	34699	\$125.00

Main Case		
Class E2		
Set Range	Part #	Price
500 mg - 1 mg	34699	\$125.00
500 mg - 100 mg	34699	\$125.00
50 g - 1 mg	34697	\$225.00
50 g - 1g	34697	\$225.00

Main Cases		
Class F1		
Set Range	Part #	Price
500 mg - 1 mg	34699	\$125.00
500 mg - 100 mg	34699	\$125.00
50 g - 1 mg	34697	\$225.00
50 g - 1g	34697	\$225.00

Main Cases		
Class F2		
Set Range	Part #	Price
500 mg - 1 mg	34699	\$125.00
500 mg - 100 mg	34699	\$125.00
50 g - 1 mg	34697	\$225.00
50 g - 1g	34697	\$225.00

Accessories

Description	Part #	Price
Statement of Accuracy	36092	\$47.50
Weight glove, white cotton	11714	\$6.75
Tweezer	11711	\$5.00
Premium tweezer	152414	\$43.00
Serial number	25836	\$17.00
Leaf weight cover	11755	\$43.00
Weight forceps, plastic	50035	\$43.00
Tong assembly, Class 0	50000	\$74.00
Lifter (Class 0 and OIML 2 kg and 5 kg)	50037	\$54.00

ASTM
PRECISION

OIML
PRECISION

BALANCE
CALIBRATION

STAINLESS
FIELD WEIGHTS

CAST IRON
FIELD WEIGHTS

ASTM
SPECIALTY

ACCESSORIES

MASS REFERENCE STANDARDS / METRIC SETS

RANGE: 100 g

Class E1 Polished Finish

Statement of Accuracy not available.

Certificate

Set Range	Part #	Price	Accredited
100 g - 1 mg	30838	\$5,325.00	Included
100 g - 100 mg	30842	\$4,175.00	Included
100 g - 1 g	30846	\$3,450.00	Included

Class E2 Polished Finish

Statement of Accuracy not available.

Certificate

Set Range	Part #	Price	Accredited
100 g - 1 mg	30839	\$2,440.00	Included
100 g - 100 mg	30843	\$1,750.00	Included
100 g - 1 g	30847	\$1,300.00	Included

Class F1 Polished Finish**Optional Certificate**

Set Range	Part #	Price	Accredited	Non-accredited
100 g - 1 mg	30840	\$1,270.00	\$830.00	\$590.00
100 g - 100 mg	30844	\$1,070.00	\$510.00	\$405.00
100 g - 1 g	30848	\$835.00	\$355.00	\$280.00

Class F2 Polished Finish**Optional Certificate**

Set Range	Part #	Price	Accredited	Non-accredited
100 g - 1 mg	30841	\$1,000.00	\$830.00	\$590.00
100 g - 100 mg	30845	\$985.00	\$510.00	\$405.00
100 g - 1 g	30849	\$800.00	\$355.00	\$280.00

Class M1 Satin Finish**Optional Certificate**

Set Range	Part #	Price	Accredited
100 g - 1 mg	119561	\$950.00	\$505.00
100 g - 1 g	119560	\$660.00	\$215.00

Replacement Cases

Main Cases		
Class E1		
Set Range	Part #	Price
100 g - 1 mg	34697	\$225.00
100 g - 100 mg	34697	\$225.00
100 g - 1 g	34697	\$225.00

Main Case		
Class E2		
Set Range	Part #	Price
100 g - 1 mg	34697	\$225.00
100 g - 100 mg	34697	\$225.00

Main Case		
Class E2		
Set Range	Part #	Price
100 g - 1 g	34697	\$225.00

Main Cases		
Class F1		
Set Range	Part #	Price
100 g - 1 mg	34697	\$225.00
100 g - 100 mg	34697	\$225.00
100 g - 1 g	34697	\$225.00

Main Cases		
Class F2		
Set Range	Part #	Price
100 g - 1 mg	34697	\$225.00
100 g - 100 mg	34697	\$225.00
100 g - 1 g	34697	\$225.00

Main Cases		
Class M1		
Set Range	Part #	Price
100 g - 1 mg	34697	\$225.00
100 g - 1 g	34697	\$225.00

RANGE: 100 g

Weight Set Contents

100 g - 1 mg	100 g - 100 mg	100 g - 1 g
30838 Class E1	30842 Class E1	30846 Class E1
30839 Class E2	30843 Class E2	30847 Class E2
30840 Class F1	30844 Class F1	30848 Class F1
30841 Class F2	30845 Class F2	30849 Class F2
119561 Class M1	–	119560 Class M1
(1) 100 g	(1) 100 g	(1) 100 g
(1) 50 g	(1) 50 g	(1) 50 g
(2) 20 g	(2) 20 g	(2) 20 g
(1) 10 g	(1) 10 g	(1) 10 g
(1) 5 g	(1) 5 g	(1) 5 g
(2) 2 g	(2) 2 g	(2) 2 g
(1) 1 g	(1) 1 g	(1) 1 g
(1) 500 mg	(1) 500 mg	
(2) 200 mg	(2) 200 mg	
(1) 100 mg	(1) 100 mg	
(1) 50 mg		
(2) 20 mg		
(1) 10 mg		
(1) 5 mg		
(2) 2 mg		
(1) 1 mg		
21 pcs. 211.11g set wt.	13 pcs. 211g set wt.	9 pcs. 210g set wt.



Accessories

Description	Part #	Price
Statement of Accuracy	36092	\$47.50
Weight glove, white cotton	11714	\$6.75
Tweezer	11711	\$5.00
Premium tweezer	152414	\$43.00
Serial number	25836	\$17.00
Leaf weight cover	11755	\$43.00
Weight forceps, plastic	50035	\$43.00

PN 30838 Set Includes Lifting Device, Glove and Case (100 g to 1 mg)

ASTM
PRECISION

OIML
PRECISION

BALANCE
CALIBRATION

STAINLESS
FIELD WEIGHTS

CAST IRON
FIELD WEIGHTS

ASTM
SPECIALTY

ACCESSORIES

MASS REFERENCE STANDARDS / METRIC SETS

RANGE: 200 g

ASTM
PRECISION

OIML
PRECISION

BALANCE
CALIBRATION

STAINLESS
FIELD WEIGHTS

CAST IRON
FIELD WEIGHTS

ASTM
SPECIALTY

ACCESSORIES

Class E1 Polished Finish
Statement of Accuracy not available.

Set Range	Part #	Price
(2) 200 g - 1mg	40546	\$5,700.00
200 g - 100 mg	40547	\$4,850.00
200 g - 1g	40548	\$4,150.00
200 g - 100 g	40549	\$2,450.00

Certificate

Accredited
Included
Included
Included
Included

Class E2 Polished Finish
Statement of Accuracy not available.

Set Range	Part #	Price
200 g - 1mg	40550	\$2,775.00
(2) 200 g - 1mg	96468	\$3,100.00
200 g - 100 mg	40551	\$2,180.00
200 g - 1g	40552	\$1,720.00
(2) 200 g - 1g	96469	\$2,070.00
(2) 200 g - 100 g	40553	\$1,380.00

Certificate

Accredited
Included
Included
Included
Included
Included
Included

Class F1 Polished Finish

Set Range	Part #	Price
200 g - 1mg	40554	\$1,790.00
(2) 200 g - 1mg	96470	\$1,830.00
200 g - 100 mg	40555	\$1,370.00
(2) 200 g - 1g	96471	\$1,230.00
200 g - 1g	40556	\$1,140.00
(2) 200 g - 100 g	40557	\$780.00

Optional Certificate

Accredited	Non-accredited
\$930.00	\$660.00
\$1,020.00	\$675.00
\$610.00	\$450.00
\$450.00	\$325.00
\$540.00	\$370.00
\$300.00	\$155.00

Class F2 Polished Finish

Set Range	Part #	Price
200 g - 1mg	40558	\$1,760.00
(2) 200 g - 1mg	96472	\$1,790.00
200 g - 100 mg	40559	\$1,230.00
(2) 200 g - 1g	96473	\$1,170.00
200 g - 1g	40560	\$1,120.00
(2) 200 g - 100 g	40561	\$775.00

Optional Certificate

Accredited	Non-accredited
\$930.00	\$660.00
\$1,020.00	\$675.00
\$610.00	\$450.00
\$450.00	\$325.00
\$540.00	\$370.00
\$300.00	\$155.00

Class M1 Satin Finish

Set Range	Part #	Price
200 g - 1mg	195668	Consult
200 g - 1g	195669	Consult

Optional Certificate

Accredited	Non-accredited
Consult	Consult
Consult	Consult

Replacement Cases

Main Cases		
Class E1		
Set Range	Part #	Price
(2) 200 g - 1mg	34645	\$330.00
200 g - 100 mg	34645	\$330.00
200 g - 1g	34645	\$330.00
200 g - 100 g	34645	\$330.00

Main Cases		
Class E2		
Set Range	Part #	Price
200 g - 1mg	34645	\$330.00
(2) 200 g - 1mg	34645	\$330.00
200 g - 100 mg	34645	\$330.00
200 g - 1g	34645	\$330.00
(2) 200 g - 1g	34645	\$330.00
(2) 200 g - 100 g	34645	\$330.00

Main Cases		
Class F1		
Set Range	Part #	Price
200 g - 1mg	34645	\$330.00
(2) 200 g - 1mg	34645	\$330.00
200 g - 100 mg	34645	\$330.00
(2) 200 g - 1g	34645	\$330.00
200 g - 1g	34645	\$330.00
(2) 200 g - 100 g	34645	\$330.00

RANGE: 200 g

Weight Set Contents

200 g - 1mg	(2) 200 g - 1mg	200 g - 100 mg	200 g - 1g	(2) 200 g - 1g	(2) 200 g - 100 g
40550 Class E1 40554 Class E2 40558 Class F1 195668 Class F2 -	40546 Class E1 96468 Class E2 96470 Class F1 96472 Class F2 -	40547 Class E1 40551 Class E2 40555 Class F1 40559 Class F2 -	40548 Class E1 40552 Class E2 40556 Class F1 40560 Class F2 195669 Class M1	- 96469 Class E2 96471 Class F1 96473 Class F2 -	40549 Class E1 40553 Class E2 40557 Class F1 40561 Class F2 -
(1) 200 g (1) 100 g (1) 50 g (2) 20 g (1) 10 g (1) 5 g (2) 2 g (1) 1 g (1) 500 mg (2) 200 mg (1) 100 mg (1) 50 mg (2) 20 mg (1) 10 mg (1) 5 mg (2) 2 mg (1) 1 mg	(2) 200 g (1) 100 g (1) 50 g (2) 20 g (1) 10 g (1) 5 g (2) 2 g (1) 1 g (1) 500 mg (2) 200 mg (1) 100 mg (1) 50 mg (2) 20 mg (1) 10 mg (1) 5 mg (2) 2 mg (1) 1 mg	(1) 200 g (1) 100 g (1) 50 g (2) 20 g (1) 10 g (1) 5 g (2) 2 g (1) 1 g (1) 500 mg (2) 200 mg (1) 100 mg	(1) 200 g (1) 100 g (1) 50 g (2) 20 g (1) 10 g (1) 5 g (2) 2 g (1) 1 g	(2) 200 g (1) 100 g (1) 50 g (2) 20 g (1) 10 g (1) 5 g (2) 2 g (1) 1 g	(2) 200 g (1) 100 g
22 pcs. 411.11g set wt.	23 pcs. 611.11g set wt.	14 pcs. 611g set wt.	10 pcs. 410g set wt.	11 pcs. 610g set wt.	3 pcs. 500g set wt.



Set Includes Lifting Device, Glove and Case

Main Cases		
Class F2		
Set Range	Part #	Price
200 g - 1mg	34645	\$330.00
(2) 200 g - 1mg	34645	\$330.00
200 g - 100 mg	34645	\$330.00
(2) 200 g - 1g	34645	\$330.00
200 g - 1g	34645	\$330.00
(2) 200 g - 100 g	34645	\$330.00

Main Cases		
Class M1		
Set Range	Part #	Price
200 g - 1mg	Consult	Consult
200 g - 1g	Consult	Consult

Inserts		
Class E1, E2, F1 and M1		
Set Range	Part #	Price
200 g - 1mg	30607	\$205.00
(2) 200 g - 1mg	84473	\$400.00
(2) 200 g - 1g	84472	\$400.00
(2) 200 g - 100 g	30608	\$395.00

Accessories

Description	Part #	Price
Statement of Accuracy	36092	\$47.50
Weight glove, white cotton	11714	\$6.75
Tweezer	11711	\$5.00
Premium tweezer	152414	\$43.00
Serial number	25836	\$17.00
Leaf weight cover	11755	\$43.00
Weight forceps, plastic	50035	\$43.00

ASTM
PRECISION

OIML
PRECISION

BALANCE
CALIBRATION

STAINLESS
FIELD WEIGHTS

CAST IRON
FIELD WEIGHTS

ASTM
SPECIALTY

ACCESSORIES

MASS REFERENCE STANDARDS / METRIC SETS

RANGE: 500 g

Class E1 Polished Finish

Statement of Accuracy not available.

Certificate

Set Range	Part #	Price	Accredited
500 g - 1mg	30822	\$6,850.00	Included
500 g - 100 mg	30826	\$6,050.00	Included
500 g - 1g	30830	\$5,475.00	Included
500 g - 100 g	30834	\$4,600.00	Included

Class E2 Polished Finish

Statement of Accuracy not available.

Certificate

Set Range	Part #	Price	Accredited
500 g - 1mg	30823	\$3,650.00	Included
500 g - 100 mg	30827	\$3,150.00	Included
500 g - 1g	30831	\$2,525.00	Included
500 g - 100 g	30835	\$1,840.00	Included

Class F1 Polished Finish**Optional Certificate**

Set Range	Part #	Price	Accredited	Non-accredited
500 g - 1mg	30824	\$2,170.00	\$1,120.00	\$715.00
500 g - 100 mg	30828	\$1,930.00	\$800.00	\$535.00
500 g - 1g	30832	\$1,610.00	\$640.00	\$410.00
500 g - 100 g	30836	\$1,410.00	\$325.00	\$165.00

Class F2 Polished Finish**Optional Certificate**

Set Range	Part #	Price	Accredited	Non-accredited
500 g - 1mg	30825	\$1,840.00	\$1,120.00	\$715.00
500 g - 100 mg	30829	\$1,710.00	\$800.00	\$535.00
500 g - 1g	30833	\$1,430.00	\$640.00	\$410.00
500 g - 100 g	30837	\$1,040.00	\$325.00	\$165.00

Class M1 Satin Finish**Optional Certificate**

Set Range	Part #	Price	Accredited	Non-accredited
500 g - 1mg	195670	Consult	Consult	Consult
500 g - 1g	195671	Consult	Consult	Consult

Replacement Cases

Main Cases		
Class E1		
Set Range	Part #	Price
500 g - 1mg	34645	\$330.00
500 g - 100 mg	34645	\$330.00
500 g - 1g	34645	\$330.00
500 g - 100 g	34645	\$330.00

Main Cases		
Class E2		
Set Range	Part #	Price
500 g - 1mg	34645	\$330.00
500 g - 100 mg	34645	\$330.00
500 g - 1g	34645	\$330.00
500 g - 100 g	34645	\$330.00

Main Cases		
Class F1		
Set Range	Part #	Price
500 g - 1mg	34645	\$330.00
500 g - 100 mg	34645	\$330.00
500 g - 1g	34645	\$330.00
500 g - 100 g	34645	\$330.00

RANGE: 500 g

Weight Set Contents

500 g to 1 mg	500 g to 100 mg	500 g - 1 g	500 g - 100 g
30822 Class E1	30826 Class E1	30830 Class E1	30834 Class E1
30823 Class E2	30827 Class E2	30831 Class E2	30835 Class E2
30824 Class F1	30828 Class F1	30832 Class F1	30836 Class F1
30825 Class F2	30829 Class F2	30833 Class F2	30837 Class F2
195670 Class M1	–	195671 Class M1	–
(1) 500 g (2) 200 g (1) 100 g (1) 50 g (2) 20 g (1) 10 g (1) 5 g (2) 2 g (1) 1 g (1) 500 mg (2) 200 mg (1) 100 mg (1) 50 mg (2) 20 mg (1) 10 mg (1) 5 mg (2) 2 mg (1) 1 mg	(1) 500 g (2) 200 g (1) 100 g (1) 50 g (2) 20 g (1) 10 g (1) 5 g (2) 2 g (1) 1 g (1) 500 mg (2) 200 mg (1) 100 mg	(1) 500 g (2) 200 g (1) 100 g (1) 50 g (2) 20 g (1) 10 g (1) 5 g (2) 2 g (1) 1 g	(1) 500 g (2) 200 g (1) 100 g
24 pcs. 1.11111 kg set wt.	16 pcs. 1.111 kg set wt.	12 pcs. 1.11 kg set wt.	4 pcs. 1 kg set wt.



Set Includes Lifting Device, Glove and Case

Main Cases		
Class F2		
Set Range	Part #	Price
500 g - 1 mg	34645	\$330.00
500 g - 100 mg	34645	\$330.00
500 g - 1 g	34645	\$330.00
500 g - 100 g	34645	\$330.00

Main Cases		
Class M1		
Set Range	Part #	Price
500 g - 1 mg	Consult	Consult
500 g - 1 g	Consult	Consult

Inserts		
Class E1, E2, F1, F2 and M1		
Set Range	Part #	Price
500 g - 1 mg	30607	\$205.00
500 g - 100 g	30608	\$395.00

Accessories

Description	Part #	Price
Statement of Accuracy	36092	\$47.50
Weight glove, white cotton	11714	\$6.75
Tweezer	11711	\$5.00
Premium tweezer	152414	\$43.00
Serial number	25836	\$17.00
Leaf weight cover	11755	\$43.00
Weight forceps, plastic	50035	\$43.00
Tong assembly 1 kg - 200 g	50000	\$74.00

ASTM
PRECISION

OIML
PRECISION

BALANCE
CALIBRATION

STAINLESS
FIELD WEIGHTS

CAST IRON
FIELD WEIGHTS

ASTM
SPECIALTY

ACCESSORIES

MASS REFERENCE STANDARDS / METRIC SETS

RANGE: 1kg

Class E1 Polished Finish

Statement of Accuracy not available.

Certificate

Set Range	Part #	Price	Accredited
1kg - 1mg	30806	\$7,825.00	Included
1kg - 100 mg	30810	\$6,625.00	Included
1kg - 1g	30814	\$5,975.00	Included
1kg - 100 g	30818	\$4,050.00	Included

Class E2 Polished Finish

Statement of Accuracy not available.

Certificate

Set Range	Part #	Price	Accredited
1kg - 1mg	30807	\$4,275.00	Included
1kg - 100 mg	30811	\$4,275.00	Included
1kg - 1g	30815	\$3,700.00	Included
1kg - 100 g	30819	\$2,950.00	Included

Class F1 Polished Finish**Optional Certificate**

Set Range	Part #	Price	Accredited	Non-accredited
1kg - 1mg	30808	\$3,075.00	\$1,120.00	\$765.00
1kg - 100 mg	30812	\$2,950.00	\$900.00	\$525.00
1kg - 1g	30816	\$2,850.00	\$730.00	\$455.00
1kg - 100 g	30820	\$2,490.00	\$415.00	\$205.00

Class F2 Polished Finish**Optional Certificate**

Set Range	Part #	Price	Accredited	Non-accredited
1kg - 1mg	30809	\$2,975.00	\$1,120.00	\$765.00
1kg - 100 mg	30813	\$2,900.00	\$900.00	\$525.00
1kg - 1g	30817	\$2,825.00	\$730.00	\$455.00
1kg - 100 g	30821	\$2,180.00	\$415.00	\$205.00

Class M1 Satin Finish**Optional Certificate**

Set Range	Part #	Price	Accredited	Non-accredited
1kg - 1mg	159154	\$2,170.00	Consult	Consult
1kg - 1g	159155	\$1,770.00	Consult	Consult

Replacement Cases

Main Cases		
Class E1		
Set Range	Part #	Price
1kg - 1mg	30605	\$1,960.00
1kg - 100 mg	30605	\$1,960.00
1kg - 1g	30605	\$1,960.00
1kg - 100 g	30606	\$1,770.00

Main Cases		
Class E2		
Set Range	Part #	Price
1kg - 1mg	30605	\$1,960.00
1kg - 100 mg	30605	\$1,960.00
1kg - 1g	30605	\$1,960.00
1kg - 100 g	30606	\$1,770.00

Main Cases		
Class F1		
Set Range	Part #	Price
1kg - 1mg	30605	\$1,960.00
1kg - 100 mg	30605	\$1,960.00
1kg - 1g	30605	\$1,960.00
1kg - 100 g	30606	\$1,770.00

RANGE: 1kg

Weight Set Contents

1kg - 1mg		1kg - 100 mg		1kg - 1g		1kg - 100 g	
30806 Class E1	30810 Class E1	30814 Class E1	30818 Class E1	30807 Class E2	30811 Class E2	30815 Class E2	30819 Class E2
30808 Class F1	30812 Class F1	30816 Class F1	30820 Class F1	30809 Class F2	30813 Class F2	30817 Class F2	30821 Class F2
159154 Class M1	–	159155 Class M1	–				
(1) 1kg	(1) 1kg	(1) 1kg	(1) 1kg	(1) 500g	(1) 500g	(1) 500g	(1) 500g
(1) 500g	(1) 500g	(1) 500g	(1) 500g	(2) 200g	(2) 200g	(2) 200g	(2) 200g
(2) 200g	(2) 200g	(2) 200g	(2) 200g	(1) 100g	(1) 100g	(1) 100g	(1) 100g
(1) 100g	(1) 100g	(1) 100g	(1) 100g	(1) 50g	(1) 50g	(1) 50g	
(1) 50g	(1) 50g	(1) 50g	(1) 50g	(2) 20g	(2) 20g	(2) 20g	
(2) 20g	(2) 20g	(2) 20g	(2) 20g	(1) 10g	(1) 10g	(1) 10g	
(1) 10g	(1) 10g	(1) 10g	(1) 10g	(1) 5g	(1) 5g	(1) 5g	
(1) 5g	(1) 5g	(1) 5g	(1) 5g	(2) 2g	(2) 2g	(2) 2g	
(2) 2g	(2) 2g	(2) 2g	(2) 2g	(1) 1g	(1) 1g	(1) 1g	
(1) 1g	(1) 1g	(1) 1g	(1) 1g	(1) 500mg	(1) 500mg		
(1) 500mg	(1) 500mg			(2) 200mg	(2) 200mg		
(2) 200mg	(2) 200mg			(1) 100mg	(1) 100mg		
(1) 100mg	(1) 100mg			(1) 50mg			
(1) 50mg				(2) 20mg			
(2) 20mg				(1) 10mg			
(1) 10mg				(1) 5mg			
(1) 5mg				(2) 2mg			
(2) 2mg				(1) 1mg			
(1) 1mg							
25 pcs. 2.11111kg set wt.	17 pcs. 2.111kg set wt.	13 pcs. 2.11kg set wt.	5 pcs. 2kg set wt.				



PN 30806 Set Includes Lifting Device, Glove and Case (1 kg to 1 mg)

ASTM
PRECISION

OIML
PRECISION

BALANCE
CALIBRATION

STAINLESS
FIELD WEIGHTS

CAST IRON
FIELD WEIGHTS

ASTM
SPECIALTY

ACCESSORIES

Main Cases		
Class F2		
Set Range	Part #	Price
1kg - 1mg	30605	\$1,960.00
1kg - 100 mg	30605	\$1,960.00
1kg - 1g	30605	\$1,960.00
1kg - 100 g	30606	\$1,770.00

Main Cases		
Class M1		
Set Range	Part #	Price
1kg - 1mg	Consult	Consult
1kg - 1g	Consult	Consult

Secondary Case		
Set Range	Part #	Price
100g - 1mg	34697	\$225.00

Accessories

Description	Part #	Price
Statement of Accuracy	36092	\$47.50
Weight glove, white cotton	11714	\$6.75
Tweezer	11711	\$5.00
Premium tweezer	152414	\$43.00
Serial number	25836	\$17.00
Leaf weight cover	11755	\$43.00
Weight forceps, plastic	50035	\$43.00
Tong assembly 1kg - 200 g	50000	\$74.00

MASS REFERENCE STANDARDS / METRIC SETS

RANGE: 2 kg

Class E1 Polished Finish

Statement of Accuracy not available.

Certificate

Set Range	Part #	Price	Accredited
2 kg - 1 mg	40518	\$10,300.00	Included
2 kg - 100 mg	40519	\$8,975.00	Included
2 kg - 1 g	40520	\$7,525.00	Included
2 kg - 100 g	40521	\$5,500.00	Included

Class E2 Polished Finish

Statement of Accuracy not available.

Certificate

Set Range	Part #	Price	Accredited
2 kg - 1 mg	40523	\$5,325.00	Included
(2) 2 kg - 1 mg	96455	\$5,875.00	Included
2 kg - 1 g	40525	\$4,200.00	Included
(2) 2 kg - 1 g	96457	\$5,300.00	Included

Class F1 Polished Finish**Optional Certificate**

Set Range	Part #	Price	Accredited	Non-accredited
2 kg - 1 mg	40528	\$4,200.00	\$1,310.00	\$900.00
(2) 2 kg - 1 mg	96459	\$4,375.00	\$1,430.00	\$960.00
2 kg - 1 g	40530	\$3,250.00	\$840.00	\$510.00
(2) 2 kg - 1 g	96461	\$3,825.00	\$960.00	\$570.00

Class F2 Polished Finish**Optional Certificate**

Set Range	Part #	Price	Accredited	Non-accredited
2 kg - 1 mg	40533	\$3,625.00	\$1,310.00	\$900.00
(2) 2 kg - 1 mg	96463	\$3,625.00	\$1,430.00	\$960.00
2 kg - 1 g	40535	\$3,200.00	\$840.00	\$510.00
(2) 2 kg - 1 g	96465	\$3,700.00	\$960.00	\$570.00

Class M1 Satin Finish**Optional Certificate**

Set Range	Part #	Price	Accredited	Non-accredited
2 kg - 1 mg	195672	\$2,775.00	Consult	Consult
2 kg - 1 g	195673	\$2,000.00	Consult	Consult



Set Includes Lifting Device, Glove and Case (1 kg to 1 mg)

Replacement Cases

Main Cases		
Class E1		
Set Range	Part #	Price
2 kg - 1 mg	84474	\$1,970.00
2 kg - 100 mg	96308	\$1,970.00
2 kg - 1 g	84474	\$1,970.00
2 kg - 100 g	96308	\$1,970.00

Main Cases		
Class E2		
Set Range	Part #	Price
2 kg - 1 mg	84474	\$1,970.00
2 kg - 100 mg	96308	\$1,970.00
2 kg - 1 g	84474	\$1,970.00
2 kg - 100 g	96308	\$1,970.00

Main Cases		
Class F1		
Set Range	Part #	Price
2 kg - 1 mg	96308	\$1,970.00
(2) 2 kg - 1 mg	84474	\$1,970.00
2 kg - 1 g	96308	\$1,970.00
(2) 2 kg - 1 g	84474	\$1,970.00

RANGE: 2 kg

Weight Set Contents

2 kg - 1 mg	2 kg - 100 mg	(2) 2 kg - 1 mg	2 kg - 1 g	(2) 2 kg - 1 g	2 kg - 100 g
40518 Class E1 40523 Class E2 40528 Class F1 40533 Class F2 195672 Class M1	40519 Class E1 - - - -	- 96455 Class E2 96459 Class F1 96463 Class F2 -	40520 Class E1 40525 Class E2 40530 Class F1 40535 Class F2 195673 Class M1	- 96457 Class E2 96461 Class F1 96465 Class F2 -	40521 Class E1 - - - -
(1) 2 kg (1) 1 kg (1) 500 g (2) 200 g (1) 100 g (1) 50 g (2) 20 g (1) 10 g (1) 5 g (2) 2 g (1) 1 g (1) 500 mg (2) 200 mg (1) 100 mg (1) 50 mg (2) 20 mg (1) 10 mg (1) 5 mg (2) 2 mg (1) 1 mg	(1) 2 kg (1) 1 kg (1) 500 g (2) 200 g (1) 100 g (1) 50 g (2) 20 g (1) 10 g (1) 5 g (2) 2 g (1) 1 g (1) 500 mg (2) 200 mg (1) 100 mg (1) 50 mg (2) 20 mg (1) 10 mg (1) 5 mg (2) 2 mg (1) 1 mg	(2) 2 kg (1) 1 kg (1) 500 g (2) 200 g (1) 100 g (1) 50 g (2) 20 g (1) 10 g (1) 5 g (2) 2 g (1) 1 g (1) 500 mg (2) 200 mg (1) 100 mg (1) 50 mg (2) 20 mg (1) 10 mg (1) 5 mg (2) 2 mg (1) 1 mg	(1) 2 kg (1) 1 kg (1) 500 g (2) 200 g (1) 100 g (1) 50 g (2) 20 g (1) 10 g (1) 5 g (2) 2 g (1) 1 g	(2) 2 kg (1) 1 kg (1) 500 g (2) 200 g (1) 100 g (1) 50 g (2) 20 g (1) 10 g (1) 5 g (2) 2 g (1) 1 g	(1) 2 kg (1) 1 kg (1) 500 g (2) 200 g (1) 100 g
26 pcs. 4.11111 kg set wt.	18 pcs. 4.111 kg set wt.	27 pcs. 6.11111 kg set wt.	14 pcs. 4.11 kg set wt.	15 pcs. 4.11 kg set wt.	6 pcs. 4.0 kg set wt.

ASTM
PRECISION

OIML
PRECISION

BALANCE
CALIBRATION

STAINLESS
FIELD WEIGHTS

CAST IRON
FIELD WEIGHTS

ASTM
SPECIALTY

ACCESSORIES

Main Cases		
Class F2		
Set Range	Part #	Price
2 kg - 1 mg	96308	\$1,970.00
(2) 2 kg - 1 mg	84474	\$1,970.00
2 kg - 1 g	96308	\$1,970.00
(2) 2 kg - 1 g	84474	\$1,970.00

Main Cases		
Class M1		
Set Range	Part #	Price
2 kg - 1 mg	Consult	Consult
2 kg - 1 g	Consult	Consult

Secondary Case		
Set Range	Part #	Price
100 g - 1 mg	34697	\$225.00

Accessories

Description	Part #	Price
Statement of Accuracy	36092	\$47.50
Weight glove, white cotton	11714	\$6.75
Tweezer	11711	\$5.00
Premium tweezer	152414	\$43.00
Serial number	25836	\$17.00
Leaf weight cover	11755	\$43.00
Weight forceps, plastic	50035	\$43.00
Tong assembly 1 kg - 200 g	50000	\$74.00
Lifter, 5 kg and 2 kg	50037	\$54.00

MASS REFERENCE STANDARDS / METRIC SETS

RANGE: 5 kg

ASTM
PRECISION

OIML
PRECISION

BALANCE
CALIBRATION

STAINLESS
FIELD WEIGHTS

CAST IRON
FIELD WEIGHTS

ASTM
SPECIALTY

ACCESSORIES

Class E1 Polished Finish
Statement of Accuracy not available.

Certificate

Set Range	Part #	Price	Accredited
5 kg - 1 mg	30785	\$12,150.00	Included
5 kg - 100 mg	30789	\$11,700.00	Included
5 kg - 1 g	30793	\$11,225.00	Included
5 kg - 100 g	30797	\$7,925.00	Included
5 kg - 1 kg	30802	\$6,700.00	Included

Class E2 Polished Finish
Statement of Accuracy not available.

Certificate

Set Range	Part #	Price	Accredited
5 kg - 1 mg	30786	\$6,925.00	Included
5 kg - 100 mg	30790	\$6,650.00	Included
5 kg - 1 g	30794	\$6,000.00	Included
5 kg - 100 g	30798	\$5,275.00	Included
5 kg - 1 kg	30803	\$4,475.00	Included

Class F1 Polished Finish

Optional Certificate

Set Range	Part #	Price	Accredited	Non-accredited
5 kg - 1 mg	30787	\$5,175.00	\$1,400.00	\$840.00
5 kg - 100 mg	30791	\$5,275.00	\$1,225.00	\$765.00
5 kg - 1 g	30795	\$4,875.00	\$1,075.00	\$635.00
5 kg - 100 g	30800	\$4,475.00	\$755.00	\$380.00
5 kg - 1 kg	30804	\$4,225.00	\$385.00	\$220.00

Class F2 Polished Finish

Optional Certificate

Set Range	Part #	Price	Accredited	Non-accredited
5 kg - 1 mg	30788	\$4,750.00	\$1,400.00	\$840.00
5 kg - 100 mg	30792	\$4,600.00	\$1,225.00	\$765.00
5 kg - 1 g	30796	\$4,200.00	\$1,075.00	\$635.00
5 kg - 100 g	30801	\$3,850.00	\$755.00	\$380.00
5 kg - 1 kg	30805	\$3,550.00	\$385.00	\$220.00

Class M1 Satin Finish

Optional Certificate

Set Range	Part #	Price	Accredited
5 kg - 1 mg	126169	\$2,750.00	\$780.00
5 kg - 1 g	126168	\$2,370.00	\$490.00

Replacement Cases

Main Cases		
Class E1		
Set Range	Part #	Price
5 kg - 1 mg	30602	\$1,920.00
5 kg - 100 mg	30602	\$1,920.00
5 kg - 1 g	30602	\$1,920.00
5 kg - 100 g	30603	\$1,920.00
5 kg - 1 kg	30604	\$1,770.00

Main Cases		
Class E2		
Set Range	Part #	Price
5 kg - 1 mg	30602	\$1,920.00
5 kg - 100 mg	30602	\$1,920.00
5 kg - 1 g	30602	\$1,920.00
5 kg - 100 g	30603	\$1,920.00
5 kg - 1 kg	30604	\$1,770.00

Main Cases		
Class F1		
Set Range	Part #	Price
5 kg - 1 mg	30602	\$1,920.00
5 kg - 100 mg	30602	\$1,920.00
5 kg - 1 g	30602	\$1,920.00
5 kg - 100 g	30603	\$1,920.00
5 kg - 1 kg	30604	\$1,770.00

RANGE: 5 kg

ASTM
PRECISION

OIML
PRECISION

BALANCE
CALIBRATION

STAINLESS
FIELD WEIGHTS

CAST IRON
FIELD WEIGHTS

ASTM
SPECIALTY

ACCESSORIES

Weight Set Contents

5 kg - 1 mg	5 kg - 100 mg	5 kg - 1 g	5 kg - 100 g	5 kg - 1 kg
30785 Class E1	30789 Class E1	30793 Class E1	30797 Class E1	30802 Class E1
30786 Class E2	30790 Class E2	30794 Class E2	30798 Class E2	30803 Class E2
30787 Class F1	30791 Class F1	30795 Class F1	30800 Class F1	30804 Class F1
30788 Class F2	30792 Class F2	30796 Class F2	30801 Class F2	30805 Class F2
126169 Class M1	-	126168 Class M1	-	-
(1) 5 kg (2) 2 kg (1) 1 kg (1) 500 g (2) 200 g (1) 100 g (1) 50 g (2) 20 g (1) 10 g (1) 5 g (2) 2 g (1) 1 g (1) 500 mg (2) 200 mg (1) 100 mg (1) 50 mg (2) 20 mg (1) 10 mg (1) 5 mg (2) 2 mg (1) 1 mg	(1) 5 kg (2) 2 kg (1) 1 kg (1) 500 g (2) 200 g (1) 100 g (1) 50 g (2) 20 g (1) 10 g (1) 5 g (2) 2 g (1) 1 g (1) 500 mg (2) 200 mg (1) 100 mg (1) 50 mg (2) 20 mg (1) 10 mg (1) 5 mg (2) 2 mg (1) 1 mg	(1) 5 kg (2) 2 kg (1) 1 kg (1) 500 g (2) 200 g (1) 100 g (1) 50 g (2) 20 g (1) 10 g (1) 5 g (2) 2 g (1) 1 g	(1) 5 kg (2) 2 kg (1) 1 kg (1) 500 g (2) 200 g (1) 100 g	(1) 5 kg (2) 2 kg (1) 1 kg
28 pcs. 11.11111 kg set wt.	20 pcs. 11.111 kg set wt.	16 pcs. 11.11 kg set wt.	8 pcs. 11 kg set wt.	4 pcs. 10 kg set wt.



Set Includes Lifting Device, Glove and Case (1 kg to 1 mg)

Main Cases		
Class F2		
Set Range	Part #	Price
5 kg - 1 mg	30602	\$1,920.00
5 kg - 100 mg	30602	\$1,920.00
5 kg - 1 g	30602	\$1,920.00
5 kg - 100 g	30603	\$1,920.00
5 kg - 1 kg	30604	\$1,770.00

Main Cases		
Class M1		
Set Range	Part #	Price
5 kg - 1 mg	126164	\$250.00
5 kg - 1 g	126164	\$250.00
Secondary Case		
Set Range	Part #	Price
100 g - 1 mg	34697	\$225.00

Accessories

Description	Part #	Price
Statement of Accuracy	36092	\$47.50
Weight glove, white cotton	11714	\$6.75
Tweezer	11711	\$5.00
Premium tweezer	152414	\$43.00
Serial number	25836	\$17.00
Leaf weight cover	11755	\$43.00
Weight forceps, plastic	50035	\$43.00
Tong assembly 1 kg - 200 g	50000	\$74.00
Lifter, 5 kg and 2 kg	50037	\$54.00

MASS REFERENCE STANDARDS / METRIC SETS

RANGE: 10 kg

Class E2 Polished Finish

Statement of Accuracy not available.

Certificate

Set Range	Part #	Price	Accredited
10 kg - 1mg	65213	\$9,850.00	Included
10 kg - 100mg	96419	\$9,525.00	Included
10 kg - 1g	96415	\$9,250.00	Included
10 kg - 100g	96420	\$8,100.00	Included
10 kg - 1kg	96421	\$7,225.00	Included

Class F1 Polished Finish**Optional Certificate**

Set Range	Part #	Price	Accredited	Non-accredited
10 kg - 1mg	65214	\$8,150.00	\$1,500.00	\$900.00
10 kg - 100mg	96429	\$8,025.00	\$1,325.00	\$820.00
10 kg - 1g	96430	\$7,875.00	\$1,180.00	\$690.00
10 kg - 100g	96467	\$7,400.00	\$870.00	\$440.00
10 kg - 1kg	96432	\$6,625.00	\$530.00	\$280.00

Class F2 Polished Finish**Optional Certificate**

Set Range	Part #	Price	Accredited	Non-accredited
10 kg - 1mg	65215	\$7,250.00	\$1,500.00	\$900.00
10 kg - 100mg	96445	\$7,125.00	\$1,325.00	\$820.00
10 kg - 1g	96446	\$7,025.00	\$1,180.00	\$690.00
10 kg - 100g	96444	\$6,450.00	\$870.00	\$440.00
10 kg - 1kg	96448	\$5,900.00	\$530.00	\$280.00

Class M1 Satin Finish**Optional Certificate**

Set Range	Part #	Price	Accredited	Non-accredited
10 kg - 1mg	195676	\$3,250.00	Consult	Consult
10 kg - 1g	195677	\$2,925.00	Consult	Consult

Replacement Cases

Main Cases		
Class E2		
Set Range	Part #	Price
10 kg - 1mg	65218	\$2,450.00
10 kg - 100mg	65218	\$2,450.00
10 kg - 1g	65218	\$2,450.00
10 kg - 100g	65218	\$2,450.00
10 kg - 1kg	65218	\$2,450.00

Main Cases		
Class F1		
Set Range	Part #	Price
10 kg - 1mg	65218	\$2,450.00
10 kg - 100mg	65218	\$2,450.00
10 kg - 1g	65218	\$2,450.00
10 kg - 100g	65218	\$2,450.00
10 kg - 1kg	65218	\$2,450.00

Main Cases		
Class F2		
Set Range	Part #	Price
10 kg - 1mg	65218	\$2,450.00
10 kg - 100mg	65218	\$2,450.00
10 kg - 1g	65218	\$2,450.00
10 kg - 100g	65218	\$2,450.00
10 kg - 1kg	65218	\$2,450.00

RANGE: 10 kg

Weight Set Contents

10 kg - 1 mg	10 kg - 100 mg	10 kg - 1 g	10 kg - 100 g	10 kg - 1 kg
65213 Class E2 65214 Class F1 65215 Class F2 195676 Class M1	96419 Class E2 96429 Class F1 96445 Class F2 -	96415 Class E2 96430 Class F1 96446 Class F2 195677 Class M1	96420 Class E2 96467 Class F1 96444 Class F2 -	96421 Class E2 96432 Class F1 96448 Class F2 -
(1) 10 kg (1) 5 kg (2) 2 kg (1) 1 kg (1) 500 g (2) 200 g (1) 100 g (1) 50 g (2) 20 g (1) 10 g (1) 5 g (2) 2 g (1) 1 g (1) 500 mg (2) 200 mg (1) 100 mg (1) 50 mg (2) 20 mg (1) 10 mg (1) 5 mg (2) 2 mg (1) 1 mg	(1) 10 kg (1) 5 kg (2) 2 kg (1) 1 kg (1) 500 g (2) 200 g (1) 100 g (1) 50 g (2) 20 g (1) 10 g (1) 5 g (2) 2 g (1) 1 g (1) 500 mg (2) 200 mg (1) 100 mg	(1) 10 kg (1) 5 kg (2) 2 kg (1) 1 kg (1) 500 g (2) 200 g (1) 100 g (1) 50 g (2) 20 g (1) 10 g (1) 5 g (2) 2 g (1) 1 g	(1) 10 kg (1) 5 kg (2) 2 kg (1) 1 kg (1) 500 g (2) 200 g (1) 100 g	(1) 10 kg (1) 5 kg (2) 2 kg (1) 1 kg
29 pcs. 21.1111kg set wt.	21 pcs. 21.11105 kg	17 pcs. 21.111 kg set wt.	9 pcs. 21 kg set wt.	5 pcs. 20 kg set wt.

ASTM
PRECISION

OIML
PRECISION

BALANCE
CALIBRATION

STAINLESS
FIELD WEIGHTS

CAST IRON
FIELD WEIGHTS

ASTM
SPECIALTY

ACCESSORIES

Accessories

Main Cases		
Set Range	Part #	Price
10 kg - 1mg	Consult	Consult
10 kg - 1g	200297	\$585.00

Secondary Case		
Set Range	Part #	Price
100 g - 1 mg	34697	\$225.00

Description	Part #	Price
Statement of Accuracy	36092	\$47.50
Weight glove, white cotton	11714	\$6.75
Tweezer	11711	\$5.00
Premium tweezer	152414	\$43.00
Serial number	25836	\$17.00
Leaf weight cover	11755	\$43.00
Weight forceps, plastic	50035	\$43.00
Tong assembly 1 kg - 200 g	50000	\$74.00
Lifter, 5 kg and 2 kg	50037	\$54.00

MASS REFERENCE STANDARDS / METRIC SETS

RANGE: 20 kg

Class E2 Polished Finish

Statement of Accuracy not available.

Certificate

Set Range	Part #	Price	Accredited
20 kg - 1mg	65210	\$13,650.00	Included
20 kg - 100 mg	96416	\$13,275.00	Included
20 kg - 1g	96414	\$12,875.00	Included
20 kg - 100 g	96417	\$11,800.00	Included
20 kg - 1kg	96418	\$10,500.00	Included

Class F1 Polished Finish**Optional Certificate**

Set Range	Part #	Price	Accredited	Non-accredited
20 kg - 1mg	65211	\$10,650.00	\$1,680.00	\$1,025.00
20 kg - 100 mg	96428	\$7,050.00	\$1,445.00	\$885.00
20 kg - 1g	96425	\$10,350.00	\$1,285.00	\$760.00
20 kg - 100 g	96426	\$9,850.00	\$975.00	\$500.00
20 kg - 1kg	96427	\$9,075.00	\$645.00	\$340.00

Class F2 Polished Finish**Optional Certificate**

Set Range	Part #	Price	Accredited	Non-accredited
20 kg - 1mg	65212	\$9,475.00	\$1,680.00	\$1,025.00
20 kg - 100 mg	96447	\$9,325.00	\$1,445.00	\$885.00
20 kg - 1g	96441	\$9,225.00	\$1,285.00	\$760.00
20 kg - 100 g	96442	\$8,775.00	\$975.00	\$500.00
20 kg - 1kg	96443	\$8,075.00	\$645.00	\$340.00

Replacement Cases

Main Cases		
Class E2		
Set Range	Part #	Price
20 kg - 1mg	65219	\$2,330.00
20 kg - 100 mg	65219	\$2,330.00
20 kg - 1g	65219	\$2,330.00
20 kg - 100 g	65219	\$2,330.00
20 kg - 1kg	65219	\$2,330.00

Main Cases		
Class F1		
Set Range	Part #	Price
20 kg - 1mg	65219	\$2,330.00
20 kg - 100 mg	65219	\$2,330.00
20 kg - 1g	65219	\$2,330.00
20 kg - 100 g	65219	\$2,330.00
20 kg - 1kg	65219	\$2,330.00

Main Cases		
Class F2		
Set Range	Part #	Price
20 kg - 1mg	65219	\$2,330.00
20 kg - 100 mg	65219	\$2,330.00
20 kg - 1g	65219	\$2,330.00
20 kg - 100 g	65219	\$2,330.00
20 kg - 1kg	65219	\$2,330.00

Secondary Case		
Set Range	Part #	Price
100 g - 1mg	34697	\$225.00

Weight Set Contents

20 kg - 1 mg		20 kg - 100 mg		20 kg - 1 g		20 kg - 100 g		20 kg - 1 kg	
65210	Class E2	96416	Class E2	96414	Class E2	96417	Class E2	96418	Class E2
65211	Class F1	96428	Class F1	96425	Class F1	96426	Class F1	96427	Class F1
65212	Class F2	96447	Class F2	96441	Class F2	96442	Class F2	96443	Class F2
(1) 20 kg		(1) 20 kg		(1) 20 kg		(1) 20 kg		(1) 20 kg	
(1) 10 kg		(1) 10 kg		(1) 10 kg		(1) 10 kg		(1) 10 kg	
(1) 5 kg		(1) 5 kg		(1) 5 kg		(1) 5 kg		(1) 5 kg	
(2) 2 kg		(2) 2 kg		(2) 2 kg		(2) 2 kg		(2) 2 kg	
(1) 1 kg		(1) 1 kg		(1) 1 kg		(1) 1 kg		(1) 1 kg	
(1) 500 g		(1) 500 g		(1) 500 g		(1) 500 g			
(2) 200 g		(2) 200 g		(2) 200 g		(2) 200 g			
(1) 100 g		(1) 100 g		(1) 100 g		(1) 100 g			
(1) 50 g		(1) 50 g		(1) 50 g					
(2) 20 g		(2) 20 g		(2) 20 g					
(1) 10 g		(1) 10 g		(1) 10 g					
(1) 5 g		(1) 5 g		(1) 5 g					
(2) 2 g		(2) 2 g		(2) 2 g					
(1) 1 g		(1) 1 g		(1) 1 g					
(1) 500 mg		(1) 500 mg							
(2) 200 mg		(2) 200 mg							
(1) 100 mg		(1) 100 mg							
(1) 50 mg									
(2) 20 mg									
(1) 10 mg									
(1) 5 mg									
(2) 2 mg									
(1) 1 mg									
30 pcs. 41.1111 kg set wt.		22 pcs. 41.1105 kg set wt.		18 pcs. 41.111 kg set wt.		10 pcs. 41 kg set wt.		6 pcs. 40 kg set wt.	

Accessories

Description	Part #	Price
Statement of Accuracy	36092	\$47.50
Weight glove, white cotton	11714	\$6.75
Tweezer	11711	\$5.00
Premium tweezer	152414	\$43.00
Serial number	25836	\$17.00
Leaf weight cover	11755	\$43.00
Weight forceps, plastic	50035	\$43.00
Tong assembly 1 kg - 200 g	50000	\$74.00
Lifter, 5 kg and 2 kg	50037	\$54.00

ASTM
PRECISION

OIML
PRECISION

BALANCE
CALIBRATION

STAINLESS
FIELD WEIGHTS

CAST IRON
FIELD WEIGHTS

ASTM
SPECIALTY

ACCESSORIES

ASTM Balance Calibration Weights

Applications:

Calibrating Class I and II balances
ASTM Class 4, 5 and 6 weights
Tolerance checking or verification
of balances

Styles Available:

Cylindrical
Grip-handle

Classes Available:

Class 1 to 2 polished finish
Class 3 to 4 satin finish
Class 1 to 7 manufactured in accordance with
ASTM E617 specification and tolerances

Product Configuration:

Single weight
Single weight kit: includes weight, case
and glove or appropriate lifting device

Features:

Nominal value marked on weights
Serial numbers may be stamped or
laser marked on weights (Class 2 to 4)
Sealing cavity for adjusting material
in 100 g or larger weights
Density 7.84 g/cm³





Metric Single Weight with Case (Kits)

84 Range: 5 kg – 10 g

Metric Single Weights Grip-handle

86 Range: 30 kg – 5 kg

Metric Single Weights Cylindrical

87 Range: 5 kg – 10 g

Avoirdupois Single Weights Grip-handle

88 Range: 50 lb – 10 lb

Avoirdupois Single Weights Cylindrical

89 Range: 10 lb – 0.05 lb

BALANCE CALIBRATION WEIGHTS / METRIC SINGLE WEIGHT WITH CASE (KIT)**RANGE: 5 kg – 10 g****Class 1** Polished Finish

Weight	Kit Part #	Price
5 kg	12958	\$755.00
4 kg	12956	\$660.00
3 kg	12954	\$400.00
2 kg	12952	\$235.00
1,500 g	12985	\$215.00
1,000 g	12971	\$195.00
600 g	12983	\$205.00
500 g	12950	\$160.00
400 g	12968	\$160.00
300 g	12966	\$150.00
200 g	12948	\$135.00
160 g	12981	\$140.00
150 g	12979	\$125.00
100 g	12946	\$115.00
50 g	12964	\$100.00
30 g	12962	\$100.00
20 g	12960	\$100.00
10 g	12944	\$100.00

Optional Certificate

Accredited	Non-Accredited
\$145.00	\$80.00
\$145.00	\$80.00
\$145.00	\$80.00
\$145.00	\$80.00
\$145.00	\$80.00
\$125.00	\$60.00
\$125.00	\$60.00
\$125.00	\$60.00
\$125.00	\$60.00
\$125.00	\$60.00
\$125.00	\$60.00
\$125.00	\$60.00
\$125.00	\$60.00
\$125.00	\$60.00
\$55.00	\$45.00
\$55.00	\$45.00
\$55.00	\$45.00
\$55.00	\$45.00
\$55.00	\$45.00

Class 2 Polished Finish

Weight	Kit Part #	Price
5 kg	13076	\$605.00
4 kg	13074	\$600.00
3 kg	13072	\$320.00
2 kg	13070	\$215.00
1,500 g	13103	\$215.00
1,000 g	13089	\$175.00
600 g	13101	\$200.00
500 g	13068	\$160.00
400 g	13086	\$155.00
300 g	13084	\$150.00
200 g	13066	\$135.00
160 g	13099	\$135.00
150 g	13097	\$120.00
100 g	13064	\$110.00
50 g	13082	\$93.00
30 g	13080	\$93.00
20 g	13078	\$93.00
10 g	13062	\$93.00

Optional Certificate

Accredited	Non-Accredited
\$145.00	\$80.00
\$145.00	\$80.00
\$145.00	\$80.00
\$145.00	\$80.00
\$145.00	\$80.00
\$125.00	\$60.00
\$125.00	\$60.00
\$125.00	\$60.00
\$125.00	\$60.00
\$125.00	\$60.00
\$125.00	\$60.00
\$125.00	\$60.00
\$125.00	\$60.00
\$55.00	\$45.00
\$55.00	\$45.00
\$55.00	\$45.00
\$55.00	\$45.00
\$55.00	\$45.00



*Kits Include a Single Weight
with Case and Glove*

Replacement Cases

Main Cases		
Class 1 and 2		
Nominal Value	Part #	Price
5 kg	197476	\$225.00
4 kg	197475	\$225.00
3 kg	190273	\$38.50
2 kg	190268	\$38.50
1,500 g	190270	\$38.50
1,000 g	190259	\$38.50
600 g	189714	\$38.50
500 g	189712	\$38.50
400 g	189709	\$38.50

Main Cases		
Class 1 and 2		
Nominal Value	Part #	Price
300 g	189643	\$38.50
200 g	194185	\$36.50
160 g	189634	\$38.50
150 g	189633	\$38.50
100 g	189567	\$42.00
50 g	189506	\$42.00
30 g	189505	\$42.00
20 g	189482	\$42.00
10 g	189475	\$42.00

Accessories

Description	Part #	Price
Statement of Accuracy	36092	\$47.50
Weight glove, white cotton	11714	\$6.75
Vinyl glove	11773	\$3.25
Serial number	25836	\$17.00

BALANCE CALIBRATION WEIGHTS / METRIC SINGLE WEIGHT WITH CASE (KIT)

RANGE: 5 kg – 10 g

Class 3 Satin Finish

Weight	Kit Part #	Price
5 kg	13179	\$575.00
4 kg	13177	\$550.00
3 kg	13175	\$310.00
2 kg	13173	\$215.00
1,500 g	13206	\$205.00
1,000 g	13192	\$175.00
600 g	13204	\$195.00
500 g	13171	\$150.00
400 g	13189	\$150.00
300 g	13187	\$130.00
200 g	13169	\$130.00
160 g	13202	\$130.00
150 g	13200	\$115.00
100 g	13167	\$110.00
50 g	13185	\$93.00
30 g	13183	\$93.00
20 g	13181	\$93.00
10 g	13165	\$93.00

Optional Certificate

Accredited	Non-Accredited
\$145.00	\$80.00
\$145.00	\$80.00
\$145.00	\$80.00
\$145.00	\$80.00
\$145.00	\$80.00
\$125.00	\$60.00
\$125.00	\$60.00
\$125.00	\$60.00
\$125.00	\$60.00
\$125.00	\$60.00
\$125.00	\$60.00
\$125.00	\$60.00
\$125.00	\$60.00
\$55.00	\$45.00
\$55.00	\$45.00
\$55.00	\$45.00
\$55.00	\$45.00
\$55.00	\$45.00



Case for 4 kg and 5 kg only

Class 4 Satin Finish

Weight	Kit Part #	Price
5 kg	13282	\$560.00
4 kg	13280	\$525.00
3 kg	13278	\$305.00
2 kg	13276	\$200.00
1,500 g	13309	\$195.00
1,000 g	13295	\$175.00
600 g	13307	\$185.00
500 g	13274	\$140.00
400 g	13292	\$135.00
300 g	13290	\$125.00
200 g	13272	\$120.00
160 g	13305	\$125.00
150 g	13303	\$110.00
100 g	13270	\$93.00
50 g	13288	\$93.00
30 g	13286	\$85.00
20 g	13284	\$85.00
10 g	13268	\$85.00

Optional Certificate

Accredited
\$75.00
\$75.00
\$75.00
\$75.00
\$75.00
\$55.00
\$55.00
\$55.00
\$55.00
\$55.00
\$55.00
\$55.00
\$55.00
\$40.00
\$40.00
\$40.00
\$40.00



Kits Include a Single Weight with Case and Glove

Replacement Cases

Main Cases		
Class 3 and 4		
Nominal Value	Part #	Price
5 kg	197476	\$225.00
4 kg	197475	\$225.00
3 kg	190273	\$38.50
2 kg	190268	\$38.50
1,500 g	190270	\$38.50
1,000 g	190259	\$38.50
600 g	189714	\$38.50
500 g	189712	\$38.50
400 g	189709	\$38.50

Main Cases		
Class 3 and 4		
Nominal Value	Part #	Price
300 g	189643	\$38.50
200 g	194185	\$36.50
160 g	189634	\$38.50
150 g	189633	\$38.50
100 g	189567	\$42.00
50 g	189506	\$42.00
30 g	189505	\$42.00
20 g	189482	\$42.00
10 g	189475	\$42.00

Accessories

Description	Part #	Price
Statement of Accuracy	36092	\$47.50
Weight glove, white cotton	11714	\$6.75
Vinyl glove	11773	\$3.25
Serial number	25836	\$17.00

ASTM
PRECISION

OIML
PRECISION

BALANCE
CALIBRATION

STAINLESS
FIELD WEIGHTS

CAST IRON
FIELD WEIGHTS

SPECIALTY

ACCESSORIES

BALANCE CALIBRATION WEIGHTS / METRIC SINGLE WEIGHTS

RANGE: 30 kg – 5 kg

Class 1 Polished Finish
Grip-handle**Optional Certificate**

Weight	Part #	Price	Accredited	Non-Accredited
30 kg	12996	\$2,170.00	\$390.00	\$85.00
25 kg	12995	\$1,870.00	\$145.00	\$80.00
24 kg	12994	\$1,810.00	\$145.00	\$80.00
20 kg	12993	\$1,640.00	\$145.00	\$80.00
16 kg	12992	\$1,450.00	\$145.00	\$80.00
10 kg	12991	\$1,040.00	\$145.00	\$80.00
8 kg	12990	\$1,020.00	\$145.00	\$80.00
5 kg	12989	\$770.00	\$145.00	\$80.00

Class 2 Polished Finish
Grip-handle**Optional Certificate**

Weight	Part #	Price	Accredited	Non-Accredited
30 kg	13114	\$1,900.00	\$390.00	\$85.00
25 kg	13113	\$1,600.00	\$145.00	\$80.00
24 kg	13112	\$1,580.00	\$145.00	\$80.00
20 kg	13111	\$1,410.00	\$145.00	\$80.00
16 kg	13110	\$1,360.00	\$145.00	\$80.00
10 kg	13109	\$950.00	\$145.00	\$80.00
8 kg	13108	\$930.00	\$145.00	\$80.00
5 kg	13107	\$615.00	\$145.00	\$80.00

Class 3 Satin Finish
Grip-handle**Optional Certificate**

Weight	Part #	Price	Accredited	Non-Accredited
30 kg	13217	\$1,720.00	\$390.00	\$85.00
25 kg	13216	\$1,490.00	\$145.00	\$80.00
24 kg	13215	\$1,450.00	\$145.00	\$80.00
20 kg	13214	\$1,270.00	\$145.00	\$80.00
16 kg	13213	\$1,090.00	\$145.00	\$80.00
10 kg	13212	\$860.00	\$145.00	\$80.00
8 kg	13211	\$800.00	\$145.00	\$80.00
5 kg	13210	\$600.00	\$145.00	\$80.00

Class 4 Satin Finish
Grip-handle**Optional Certificate**

Weight	Part #	Price	Accredited
30 kg	13320	\$1,590.00	\$80.00
25 kg	13319	\$1,350.00	\$75.00
24 kg	13318	\$1,280.00	\$75.00
20 kg	13317	\$1,100.00	\$75.00
16 kg	13316	\$970.00	\$75.00
10 kg	13315	\$765.00	\$75.00
8 kg	13314	\$755.00	\$75.00
5 kg	13313	\$530.00	\$75.00



Replacement Cases

Main Cases		
Class 1, 2, 3 and 4		
Nominal Value	Part #	Price
30 kg	Consult	Consult
25 kg	Consult	Consult
24 kg	Consult	Consult
20 kg	Consult	Consult
16 kg	Consult	Consult
10 kg	Consult	Consult
8 kg	Consult	Consult
5 kg	Consult	Consult

BALANCE CALIBRATION WEIGHTS / METRIC SINGLE WEIGHTS

RANGE: 5 kg – 10 g

Class 1 Polished Finish Cylindrical

Weight	Part #	Price
5 kg	12959	\$725.00
4 kg	12957	\$630.00
3 kg	12955	\$375.00
2 kg	12953	\$215.00
1,500 g	12986	\$190.00
1,000 g	12972	\$160.00
600 g	12984	\$175.00
500 g	12951	\$135.00
400 g	12969	\$130.00
300 g	12967	\$125.00
200 g	12949	\$125.00
160 g	12982	\$135.00
150 g	12980	\$93.00
100 g	12947	\$85.00
50 g	12965	\$79.00
30 g	12963	\$79.00
20 g	12961	\$79.00
10 g	12945	\$79.00

Optional Certificate

Accredited	Non-Accredited
\$145.00	\$80.00
\$145.00	\$80.00
\$145.00	\$80.00
\$145.00	\$80.00
\$145.00	\$80.00
\$125.00	\$60.00
\$125.00	\$60.00
\$125.00	\$60.00
\$125.00	\$60.00
\$125.00	\$60.00
\$125.00	\$60.00
\$125.00	\$60.00
\$125.00	\$60.00
\$125.00	\$60.00
\$55.00	\$45.00
\$55.00	\$45.00
\$55.00	\$45.00
\$55.00	\$45.00

Class 3 Satin Finish Cylindrical

Weight	Part #	Price
5 kg	13180	\$550.00
4 kg	13178	\$520.00
3 kg	13176	\$285.00
2 kg	13174	\$185.00
1,500 g	13207	\$185.00
1,000 g	13193	\$150.00
600 g	13205	\$155.00
500 g	13172	\$120.00
400 g	13190	\$120.00
300 g	13188	\$110.00
200 g	13170	\$100.00
160 g	13203	\$125.00
150 g	13201	\$79.00
100 g	13168	\$73.00
50 g	13186	\$68.00
30 g	13184	\$68.00
20 g	13182	\$68.00
10 g	13166	\$68.00

Optional Certificate

Accredited	Non-Accredited
\$145.00	\$80.00
\$145.00	\$80.00
\$145.00	\$80.00
\$145.00	\$80.00
\$145.00	\$80.00
\$125.00	\$60.00
\$125.00	\$60.00
\$125.00	\$60.00
\$125.00	\$60.00
\$125.00	\$60.00
\$125.00	\$60.00
\$125.00	\$60.00
\$125.00	\$60.00
\$125.00	\$60.00
\$55.00	\$45.00
\$55.00	\$45.00
\$55.00	\$45.00
\$55.00	\$45.00

Class 2 Polished Finish Cylindrical

Weight	Part #	Price
5 kg	13077	\$580.00
4 kg	13075	\$570.00
3 kg	13073	\$295.00
2 kg	13071	\$195.00
1,500 g	13104	\$190.00
1,000 g	13090	\$155.00
600 g	13102	\$160.00
500 g	13069	\$130.00
400 g	13087	\$125.00
300 g	13085	\$115.00
200 g	13067	\$115.00
160 g	13100	\$125.00
150 g	13098	\$85.00
100 g	13065	\$79.00
50 g	13083	\$73.00
30 g	13081	\$73.00
20 g	13079	\$73.00
10 g	13063	\$73.00

Optional Certificate

Accredited	Non-Accredited
\$145.00	\$80.00
\$145.00	\$80.00
\$145.00	\$80.00
\$145.00	\$80.00
\$145.00	\$80.00
\$125.00	\$60.00
\$125.00	\$60.00
\$125.00	\$60.00
\$125.00	\$60.00
\$125.00	\$60.00
\$125.00	\$60.00
\$125.00	\$60.00
\$125.00	\$60.00
\$55.00	\$45.00
\$55.00	\$45.00
\$55.00	\$45.00
\$55.00	\$45.00

Class 4 Satin Finish Cylindrical

Weight	Part #	Price
5 kg	13283	\$480.00
4 kg	13281	\$450.00
3 kg	13279	\$280.00
2 kg	13277	\$175.00
1,500 g	13310	\$170.00
1,000 g	13296	\$150.00
600 g	13308	\$150.00
500 g	13275	\$115.00
400 g	13293	\$115.00
300 g	13291	\$100.00
200 g	13273	\$93.00
160 g	13306	\$120.00
150 g	13304	\$66.00
100 g	13271	\$68.00
50 g	13289	\$68.00
30 g	13287	\$68.00
20 g	13285	\$68.00
10 g	13269	\$68.00

Optional Certificate

Accredited
\$75.00
\$75.00
\$75.00
\$75.00
\$75.00
\$55.00
\$55.00
\$55.00
\$55.00
\$55.00
\$55.00
\$55.00
\$55.00
\$40.00
\$40.00
\$40.00
\$40.00

Replacement Cases

Main Cases		
Class 1, 2, 3 and 4		
Nominal Value	Part #	Price
5 kg	197476	\$225.00
4 kg	197475	\$225.00
3 kg	190273	\$38.50
2 kg	190268	\$38.50
1,500 g	190270	\$38.50
1,000 g	190259	\$38.50
600 g	189714	\$38.50
500 g	189712	\$38.50
400 g	189709	\$38.50

Main Cases		
Class 1, 2, 3 and 4		
Nominal Value	Part #	Price
300 g	189643	\$38.50
200 g	194185	\$36.50
160 g	189634	\$38.50
150 g	189633	\$38.50
100 g	189567	\$42.00
50 g	189506	\$42.00
30 g	189505	\$42.00
20 g	189482	\$42.00
10 g	189475	\$42.00



ASTM
PRECISION

OIML
PRECISION

BALANCE
CALIBRATION

STAINLESS
FIELD WEIGHTS

CAST IRON
FIELD WEIGHTS

SPECIALTY

ACCESSORIES

BALANCE CALIBRATION WEIGHTS / AVOIRDUPOIS SINGLE WEIGHTS

RANGE: 50 lb – 10 lb

Class 1 Polished Finish
Grip-handle**Optional Certificate**

Weight	Part #	Price	Accredited	Non-Accredited
50 lb	13038	\$1,870.00	\$285.00	\$85.00
30 lb	13037	\$1,460.00	\$130.00	\$85.00
25 lb	13036	\$1,040.00	\$130.00	\$85.00
20 lb	13035	\$1,040.00	\$130.00	\$85.00
10 lb	13034	\$755.00	\$130.00	\$85.00

Class 2 Polished Finish
Grip-handle**Optional Certificate**

Weight	Part #	Price	Accredited	Non-Accredited
50 lb	13155	\$1,600.00	\$285.00	\$85.00
30 lb	13154	\$1,180.00	\$130.00	\$85.00
25 lb	13153	\$920.00	\$130.00	\$85.00
20 lb	13152	\$885.00	\$130.00	\$85.00
10 lb	13151	\$615.00	\$130.00	\$85.00

Class 3 Satin Finish
Grip-handle**Optional Certificate**

Weight	Part #	Price	Accredited	Non-Accredited
50 lb	13258	\$1,500.00	\$285.00	\$85.00
30 lb	13257	\$1,040.00	\$130.00	\$85.00
25 lb	13256	\$795.00	\$130.00	\$85.00
20 lb	13255	\$775.00	\$130.00	\$85.00
10 lb	13254	\$605.00	\$130.00	\$85.00

Class 4 Satin Finish
Grip-handle**Optional Certificate**

Weight	Part #	Price	Accredited
50 lb	13361	\$1,480.00	\$80.00
30 lb	13360	\$985.00	\$80.00
25 lb	13359	\$725.00	\$80.00
20 lb	13358	\$645.00	\$80.00
10 lb	13357	\$495.00	\$80.00



Replacement Cases

Main Cases		
Class 1, 2, 3 and 4		
Nominal Value	Part #	Price
50 lb	Consult	Consult
30 lb	Consult	Consult
25 lb	Consult	Consult
20 lb	Consult	Consult
10 lb	Consult	Consult

BALANCE CALIBRATION WEIGHTS / AVOIRDUPOIS SINGLE WEIGHTS

RANGE: 10 lb – 0.05 lb

Class 1 Polished Finish
Cylindrical

Weight	Part #	Price
10 lb	13022	\$735.00
5 lb	13020	\$375.00
4 lb	13018	\$215.00
3 lb	13016	\$190.00
2 lb	13014	\$170.00
1 lb	13012	\$135.00
8 oz	13010	\$115.00
4 oz	13008	\$110.00
2 oz	13006	\$100.00
1 oz	13004	\$100.00
1/2 oz	13002	\$93.00
0.5 lb	13033	\$115.00
0.2 lb	13025	\$110.00
0.1 lb	13027	\$100.00
0.05 lb	13029	\$93.00

Optional Certificate

Accredited	Non-Accredited
\$130.00	\$85.00
\$130.00	\$85.00
\$130.00	\$85.00
\$130.00	\$85.00
\$105.00	\$70.00
\$105.00	\$70.00
\$55.00	\$45.00
\$55.00	\$45.00
\$55.00	\$45.00
\$55.00	\$45.00
\$55.00	\$45.00
\$55.00	\$45.00
\$55.00	\$45.00
\$55.00	\$45.00
\$55.00	\$45.00
\$55.00	\$45.00

Class 3 Satin Finish
Cylindrical

Weight	Part #	Price
10 lb	13242	\$520.00
5 lb	13240	\$295.00
4 lb	13238	\$195.00
3 lb	13236	\$185.00
2 lb	13234	\$150.00
1 lb	13232	\$125.00
8 oz	13230	\$100.00
4 oz	13228	\$84.00
2 oz	13226	\$79.00
1 oz	13224	\$73.00
1/2 oz	13222	\$73.00
0.5 lb	13253	\$100.00
0.2 lb	13245	\$68.00
0.1 lb	13247	\$68.00
0.05 lb	13249	\$68.00

Optional Certificate

Accredited	Non-Accredited
\$130.00	\$85.00
\$130.00	\$85.00
\$130.00	\$85.00
\$130.00	\$85.00
\$105.00	\$70.00
\$105.00	\$70.00
\$55.00	\$45.00
\$55.00	\$45.00
\$55.00	\$45.00
\$55.00	\$45.00
\$55.00	\$45.00
\$55.00	\$45.00
\$55.00	\$45.00
\$55.00	\$45.00
\$55.00	\$45.00
\$55.00	\$45.00

Class 2 Polished Finish
Cylindrical

Weight	Part #	Price
10 lb	13139	\$575.00
5 lb	13137	\$310.00
4 lb	13135	\$200.00
3 lb	13133	\$185.00
2 lb	13131	\$155.00
1 lb	13129	\$130.00
8 oz	13127	\$110.00
4 oz	13125	\$84.00
2 oz	13123	\$79.00
1 oz	13121	\$79.00
1/2 oz	13119	\$79.00
0.5 lb	13150	\$100.00
0.2 lb	13142	\$79.00
0.1 lb	13144	\$79.00
0.05 lb	13146	\$79.00

Optional Certificate

Accredited	Non-Accredited
\$130.00	\$85.00
\$130.00	\$85.00
\$130.00	\$85.00
\$130.00	\$85.00
\$105.00	\$70.00
\$105.00	\$70.00
\$55.00	\$45.00
\$55.00	\$45.00
\$55.00	\$45.00
\$55.00	\$45.00
\$55.00	\$45.00
\$55.00	\$45.00
\$55.00	\$45.00
\$55.00	\$45.00
\$55.00	\$45.00

Class 4 Satin Finish
Cylindrical

Weight	Part #	Price
10 lb	13345	\$495.00
5 lb	13343	\$285.00
4 lb	13341	\$190.00
3 lb	13339	\$175.00
2 lb	13337	\$150.00
1 lb	13335	\$120.00
8 oz	13333	\$93.00
4 oz	13331	\$79.00
2 oz	13329	\$73.00
1 oz	13327	\$68.00
1/2 oz	13325	\$68.00
0.5 lb	13356	\$93.00
0.2 lb	13348	\$68.00
0.1 lb	13350	\$68.00
0.05 lb	13352	\$68.00

Optional Certificate

Accredited
\$80.00
\$80.00
\$80.00
\$80.00
\$65.00
\$65.00
\$40.00
\$40.00
\$40.00
\$40.00
\$40.00
\$40.00
\$40.00
\$40.00
\$40.00

Replacement Cases

Main Cases		
Class 1, 2, 3 and 4		
Nominal Value	Part #	Price
10 lb	197473	\$225.00
5 lb	190269	\$38.50
4 lb	190267	\$38.50
3 lb	190263	\$38.50
2 lb	190260	\$38.50
1 lb	189710	\$38.50
8 oz	189635	\$38.50
4 oz	189568	\$42.00

Main Cases		
Class 1, 2, 3 and 4		
Nominal Value	Part #	Price
2 oz	189565	\$42.00
1 oz	189484	\$42.00
1/2 oz	189476	\$42.00
0.5 lb	189635	\$38.50
0.2 lb	189565	\$42.00
0.1 lb	189507	\$42.00
0.05 lb	189483	\$42.00



ASTM
PRECISION

OIML
PRECISION

BALANCE
CALIBRATION

STAINLESS
FIELD WEIGHTS

CAST IRON
FIELD WEIGHTS

SPECIALTY

ACCESSORIES

BALANCE CALIBRATION WEIGHTS / AVOIRDUPOIS SINGLE WEIGHT WITH CASE (KIT)**RANGE: 10 lb – 0.05 lb****Class 1** Polished Finish

Weight	Part #	Price
10 lb	13021	\$755.00
5 lb	13019	\$400.00
4 lb	13017	\$235.00
3 lb	13015	\$215.00
2 lb	13013	\$195.00
1 lb	13011	\$160.00
8 oz	13009	\$135.00
4 oz	13007	\$130.00
2 oz	13005	\$125.00
1 oz	13003	\$125.00
1/2 oz	13001	\$125.00
0.5 lb	13032	\$135.00
0.2 lb	13024	\$130.00
0.1 lb	13026	\$125.00
0.05 lb	13028	\$125.00

Optional Certificate

Accredited	Non-Accredited
\$130.00	\$85.00
\$130.00	\$85.00
\$130.00	\$85.00
\$130.00	\$85.00
\$105.00	\$70.00
\$105.00	\$70.00
\$55.00	\$45.00
\$55.00	\$45.00
\$55.00	\$45.00
\$55.00	\$45.00
\$55.00	\$45.00
\$55.00	\$45.00
\$55.00	\$45.00
\$55.00	\$45.00
\$55.00	\$45.00
\$55.00	\$45.00
\$55.00	\$45.00

Class 2 Polished Finish

Weight	Part #	Price
10 lb	13138	\$605.00
5 lb	13136	\$320.00
4 lb	13134	\$230.00
3 lb	13132	\$215.00
2 lb	13130	\$175.00
1 lb	13128	\$160.00
8 oz	13126	\$130.00
4 oz	13124	\$110.00
2 oz	13122	\$110.00
1 oz	13120	\$110.00
1/2 oz	13118	\$110.00
0.5 lb	13149	\$130.00
0.2 lb	13141	\$110.00
0.1 lb	13143	\$110.00
0.05 lb	13145	\$110.00

Optional Certificate

Accredited	Non-Accredited
\$130.00	\$85.00
\$130.00	\$85.00
\$130.00	\$85.00
\$130.00	\$85.00
\$105.00	\$70.00
\$105.00	\$70.00
\$55.00	\$45.00
\$55.00	\$45.00
\$55.00	\$45.00
\$55.00	\$45.00
\$55.00	\$45.00
\$55.00	\$45.00
\$55.00	\$45.00
\$55.00	\$45.00
\$55.00	\$45.00
\$55.00	\$45.00



*Kits Include a Single Weight
with Case and Glove*

Replacement Cases

Main Cases		
Class 1 and 2		
Nominal Value	Part #	Price
10 lb	197473	\$225.00
5 lb	190269	\$38.50
4 lb	190267	\$38.50
3 lb	190263	\$38.50
2 lb	190260	\$38.50
1 lb	189710	\$38.50
8 oz	189635	\$38.50
4 oz	189568	\$42.00
2 oz	189565	\$42.00

Main Cases		
Class 1 and 2		
Nominal Value	Part #	Price
1 oz	189484	\$42.00
1/2 oz	189476	\$42.00
0.5 lb	189635	\$38.50
0.2 lb	190126	\$38.50
0.1 lb	189507	\$42.00
0.05 lb	189483	\$42.00

Accessories

Description	Part #	Price
Statement of Accuracy	36092	\$47.50
Weight glove, white cotton	11714	\$6.75
Vinyl glove	11773	\$3.25
Serial number	25836	\$17.00

BALANCE CALIBRATION WEIGHTS / AVOIRDUPOIS SINGLE WEIGHT WITH CASE (KIT)

RANGE: 10 lb – 0.05 lb

Class 3 Satin Finish

Weight	Part #	Price
10 lb	13241	\$545.00
5 lb	13239	\$320.00
4 lb	13237	\$230.00
3 lb	13235	\$215.00
2 lb	13233	\$175.00
1 lb	13231	\$150.00
8 oz	13229	\$130.00
4 oz	13227	\$110.00
2 oz	13225	\$110.00
1 oz	13223	\$110.00
1/2 oz	13221	\$110.00
0.5 lb	13252	\$130.00
0.2 lb	13244	\$100.00
0.1 lb	13246	\$100.00
0.05 lb	13248	\$100.00

Optional Certificate

Accredited	Non-Accredited
\$130.00	\$85.00
\$130.00	\$85.00
\$130.00	\$85.00
\$130.00	\$85.00
\$105.00	\$70.00
\$105.00	\$70.00
\$55.00	\$45.00
\$55.00	\$45.00
\$55.00	\$45.00
\$55.00	\$45.00
\$55.00	\$45.00
\$55.00	\$45.00
\$55.00	\$45.00
\$55.00	\$45.00
\$55.00	\$45.00
\$55.00	\$45.00
\$55.00	\$45.00

Class 4 Satin Finish

Weight	Part #	Price
10 lb	13344	\$525.00
5 lb	13342	\$310.00
4 lb	13340	\$220.00
3 lb	13338	\$200.00
2 lb	13336	\$175.00
1 lb	13334	\$140.00
8 oz	13332	\$120.00
4 oz	13330	\$110.00
2 oz	13328	\$110.00
1 oz	13326	\$100.00
1/2 oz	13324	\$100.00
0.5 lb	13355	\$125.00
0.2 lb	13347	\$93.00
0.1 lb	13349	\$93.00
0.05 lb	13351	\$93.00

Optional Certificate

Accredited
\$80.00
\$80.00
\$80.00
\$80.00
\$65.00
\$65.00
\$40.00
\$40.00
\$40.00
\$40.00
\$40.00
\$40.00
\$40.00
\$40.00
\$40.00
\$40.00
\$40.00



Kits Include a Single Weight with Case and Glove

ASTM
PRECISION

OIML
PRECISION

BALANCE
CALIBRATION

STAINLESS
FIELD WEIGHTS

CAST IRON
FIELD WEIGHTS

SPECIALTY

ACCESSORIES

Replacement Cases

Main Cases		
Class 3 and 4		
Nominal Value	Part #	Price
10 lb	197473	\$225.00
5 lb	190269	\$38.50
4 lb	190267	\$38.50
3 lb	190263	\$38.50
2 lb	190260	\$38.50
1 lb	189710	\$38.50
8 oz	189635	\$38.50
4 oz	189568	\$42.00
2 oz	189565	\$42.00

Main Cases		
Class 3 and 4		
Nominal Value	Part #	Price
1 oz	189484	\$42.00
1/2 oz	189476	\$42.00
0.5 lb	189635	\$38.50
0.2 lb	190126	\$38.50
0.1 lb	189507	\$42.00
0.05 lb	189483	\$42.00

Accessories

Description	Part #	Price
Statement of Accuracy	36092	\$47.50
Weight glove, white cotton	11714	\$6.75
Vinyl glove	11773	\$3.25
Serial number	25836	\$17.00

5

ASTM Stainless Steel Field Weights

Applications:

Field standards for Class III scales or balances

Testing non-classified scale equipment

Tolerance checking

Designs Available:

Cylindrical

Grip-handle

Product Configuration:

Single weight

Weight set includes weights, case and handling equipment

Weight set configuration: 5-2-2-1 or 5-3-2-1

Example: (1) 50 g, (2) 20 g and (1) 10 g or (1) 50 g, (1) 30 g, (1) 20 g and (1) 10 g

Appropriate lifting device, tweezer and/or glove

Features:

Stainless steel weights designed to meet NIST Handbook 44 and 105-1

ASTM Class 5 tolerance

Sealing cavity for adjustment on most weights

Serial numbers may be stamped on weights (optional)

Nominal value marked on weights



Metric Single Weights

92 Range: 30 kg – 1mg

Avoirdupois Single Weights

93 Range: 50 lb – 10 lb

94 Range: 10 lb – 0.001lb

Metric Sets

95 Range: 5 g and 50 g

96 Range: 100 g

97 Range: 500 g

98 Range: 1kg

99 Range: 2 kg

100 Range: 5 kg

Avoirdupois Sets

101 Range: 4 oz

102 Range: 1lb

103 Range: 2 lb

104 Range: 5 lb

106 Range: 10 lb

STAINLESS STEEL / METRIC SINGLE WEIGHTS

RANGE: 30 kg – 1 mg

ASTM

Class 5

Grip-handle

Weight	Part #	Height	Diameter	Price
30 kg	12572	9-3/16 in (233 mm)	6 in (152 mm)	\$1,290.00
25 kg	12571	7-3/16 in (183 mm)	6 in (152 mm)	\$1,020.00
20 kg	12569	6-7/16 in (164 mm)	6 in (152 mm)	\$885.00
10 kg	12567	5-3/16 in (132 mm)	5 in (127 mm)	\$625.00
8 kg	12565	4-13/32 in (112 mm)	5 in (127 mm)	\$585.00
5 kg	12564	3-7/32 in (82 mm)	5 in (127 mm)	\$340.00

Optional Certificate

Accredited
\$80.00
\$75.00
\$75.00
\$75.00
\$75.00
\$75.00



Class 5

Cylindrical

Weight	Part #	Height	Diameter	Price
5 kg	12521	4-13/32 in (112 mm)	3-1/2 in (89 mm)	\$250.00
4 kg	12519	3-3/16 in (97 mm)	3-3/8 in (85 mm)	\$230.00
3 kg	12517	3-23/32 in (95 mm)	3 in (76 mm)	\$205.00
2 kg	12515	3-5/16 in (84 mm)	2-5/8 in (66 mm)	\$150.00
1 kg	12513	2-11/16 in (68 mm)	2 in (50 mm)	\$85.00
500 g	12511	2-1/8 in (54 mm)	1-5/8 in (41 mm)	\$80.00
400 g	12531	2-1/32 in (52 mm)	1-1/2 in (38 mm)	\$73.00
300 g	12529	1-13/16 in (46 mm)	1-3/8 in (35 mm)	\$73.00
200 g	12509	1-21/32 in (42 mm)	1-3/16 in (30 mm)	\$62.00
150 g	12549	1-9/32 in (33 mm)	1-3/16 in (30 mm)	\$54.00
100 g	12507	1-3/16 in (30 mm)	1 in (25 mm)	\$51.00
50 g	12527	31/32 in (25 mm)	3/4 in (19 mm)	\$46.50
30 g	12525	11/16 in (17 mm)	11/16 in (17 mm)	\$43.00
20 g	12523	5/8 in (16 mm)	19/32 in (15 mm)	\$43.00
10 g	12505	19/32 in (15 mm)	7/16 in (11 mm)	\$43.00
5 g	12503	13/32 in (10 mm)	3/8 in (10 mm)	\$37.50
3 g	12533	3/8 in (9 mm)	5/16 in (8 mm)	\$37.50
2 g	12501	5/16 in (8 mm)	9/32 in (7 mm)	\$37.50
1 g	12499	1/4 in (6 mm)	7/32 in (6 mm)	\$37.50

Optional Certificate

Accredited
\$75.00
\$75.00
\$75.00
\$75.00
\$55.00
\$55.00
\$55.00
\$55.00
\$55.00
\$55.00
\$40.00
\$40.00
\$40.00
\$40.00
\$40.00
\$40.00
\$40.00
\$40.00
\$40.00
\$40.00



Class 5

Leaf (Milligram)

Optional Certificate

Weight	Part #	Price	Accredited
500 mg	12913	\$24.25	\$40.00
300 mg	12914	\$24.25	\$40.00
200 mg	12915	\$24.25	\$40.00
100 mg	12916	\$24.25	\$40.00
50 mg	12917	\$24.25	\$40.00
30 mg	12918	\$24.25	\$40.00
20 mg	12919	\$24.25	\$40.00
10 mg	12920	\$24.25	\$40.00
5 mg	12921	\$24.25	\$40.00
3 mg	12922	\$24.25	\$40.00
2 mg	12923	\$24.25	\$40.00
1 mg	12924	\$24.25	\$40.00



Replacement Cases

Main Cases		
Cylindrical Class 5		
Nominal Value	Part #	Price
5 kg	197476	\$225.00
4 kg	197475	\$225.00
3 kg	190273	\$38.50
2 kg	190268	\$38.50
1 kg	190259	\$38.50
500 g	189712	\$38.50
400 g	189709	\$38.50
300 g	189643	\$38.50
200 g	194185	\$36.50

Main Cases		
Cylindrical Class 5		
Nominal Value	Part #	Price
150 g	189633	\$38.50
100 g	189567	\$42.00
50 g	189506	\$42.00
30 g	190126	\$38.50
20 g	189482	\$42.00
10 g	189475	\$42.00
5 g	194048	\$40.00
3 g	194030	\$40.00

Accessories

Description	Part #	Price
Statement of Accuracy	36092	\$47.50
Serial number	25836	\$17.00

STAINLESS STEEL / AVOIRDUPOIS SINGLE WEIGHTS

RANGE: 50 lb – 10 lb

ASTM

Class 5
Grip-handle

Optional Certificate

Weight	Part #	Height	Diameter	Price	Accredited
50 lb	12677	6-21/32 in (169 mm)	6 in (152 mm)	\$965.00	\$80.00
30 lb	12676	6-11/16 in (170 mm)	5 in (127 mm)	\$735.00	\$80.00
25 lb	12675	5-3/4 in (146 mm)	5 in (127 mm)	\$615.00	\$80.00
20 lb	12674	4-27/32 in (123 mm)	5 in (127 mm)	\$570.00	\$80.00
10 lb	12673	3-1/32 in (77 mm)	5 in (127 mm)	\$340.00	\$80.00



Accessories

Description	Part #	Price
Statement of Accuracy	36092	\$47.50
Serial number	25836	\$17.00

ASTM
PRECISION

OIML
PRECISION

BALANCE
CALIBRATION

STAINLESS
FIELD WEIGHTS

CAST IRON
FIELD WEIGHTS

ASTM
SPECIALTY

ACCESSORIES

STAINLESS STEEL / AVOIRDUPOIS SINGLE WEIGHTS

RANGE: 10 lb – 0.001 lb

ASTM

Class 5

Cylindrical

Weight	Part #	Height	Diameter	Price	Optional Certificate	Accredited
10 lb	12606	4-1/16 in (103 mm)	3-1/2 in (88 mm)	\$235.00		\$80.00
5 lb	12604	3-11/16 in (93 mm)	2-5/8 in (66 mm)	\$150.00		\$80.00
4 lb	12602	3-1/16 in (77 mm)	2-5/8 in (66 mm)	\$145.00		\$80.00
3 lb	12600	2-15/16 in (74 mm)	2-1/4 in (57 mm)	\$140.00		\$80.00
2 lb	12598	2-15/32 in (63 mm)	2 in (51 mm)	\$79.00		\$65.00
1 lb	12596	2-9/32 in (58 mm)	1-1/2 in (38 mm)	\$68.00		\$65.00
12 oz	12626	2-1/16 in (52 mm)	1-3/8 in (35 mm)	\$62.00		\$40.00
8 oz	12594	1-21/32 in (42 mm)	1-1/4 in (32 mm)	\$54.00		\$40.00
4 oz	12592	1-11/32 in (34 mm)	1 in (25 mm)	\$48.50		\$40.00
2 oz	12590	15/16 in (24 mm)	13/16 in (21 mm)	\$46.50		\$40.00
1 oz	12587	13/16 in (20 mm)	5/8 in (16 mm)	\$43.00		\$40.00
1/2 oz	12584	21/32 in (17 mm)	1/2 in (13 mm)	\$43.00		\$40.00
1/4 oz	12581	5/8 in (16 mm)	3/8 in (10 mm)	\$37.50		\$40.00
1/8 oz	12578	7/16 in (11 mm)	5/16 in (8 mm)	\$37.50		\$40.00
1/16 oz	12575	3/8 in (10 mm)	1/4 in (6 mm)	\$37.50		\$40.00
1/32 oz	12608	11/32 in (9 mm)	3/16 in (5 mm)	\$37.50		\$40.00
0.5 oz	12647	21/32 in (17 mm)	1/2 in (13 mm)	\$43.00		\$40.00
0.3 oz	12645	17/32 in (14 mm)	7/16 in (11 mm)	\$43.00		\$40.00
0.2 oz	12643	1/2 in (13 mm)	3/8 in (9 mm)	\$43.00		\$40.00
0.1 oz	12641	3/8 in (9 mm)	5/16 in (8 mm)	\$43.00		\$40.00
0.05 oz	12639	5/16 in (7 mm)	1/4 in (6 mm)	\$43.00		\$40.00
0.5 lb	12624	1-21/32 in (42 mm)	1 1/4 in (32 mm)	\$54.00		\$40.00
0.3 lb	12622	1-3/16 in (30 mm)	1 1/8 in (28 mm)	\$54.00		\$40.00
0.2 lb	12610	1-7/32 in (31 mm)	15/16 in (24 mm)	\$46.50		\$40.00
0.1 lb	12612	7/8 in (22 mm)	3/4 in (19 mm)	\$46.50		\$40.00
0.05 lb	12614	23/32 in (18 mm)	19/32 in (15 mm)	\$46.50		\$40.00
0.03 lb	12620	5/8 in (16 mm)	1/2 in (12 mm)	\$46.50		\$40.00
0.02 lb	12616	9/16 in (14 mm)	7/16 in (11 mm)	\$46.50		\$40.00
0.01 lb	12618	17/32 in (14 mm)	5/16 in (8 mm)	\$46.50		\$40.00
0.005 lb	198340	7/16 in (11 mm)	15/64 in (6 mm)	\$43.00		\$40.00
0.003 lb	198344	7/64 in (7 mm)	15/64 in (6 mm)	\$43.00		\$40.00
0.002 lb	198341	21/64 in (9 mm)	11/64 in (4 mm)	\$43.00		\$40.00
0.001 lb	198343	3/16 in (5 mm)	11/64 in (4 mm)	\$43.00		\$40.00



Replacement Cases

Main Cases		
Class 5		
Nominal Vaule	Part #	Price
10 lb	197473	\$225.00
5 lb	190269	\$38.50
4 lb	190267	\$38.50
3 lb	190263	\$38.50
2 lb	190260	\$38.50
1 lb	189710	\$38.50
12 oz	189636	\$38.50
8 oz	189635	\$38.50
4 oz	189567	\$42.00
2 oz	189565	\$42.00
1 oz	189484	\$42.00
1/2 oz	189476	\$42.00
1/4 oz	194054	\$40.00
1/8 oz	194032	\$40.00
1/16 oz	189234	\$42.00
1/32 oz	190126	\$38.50
0.5 oz	189476	\$42.00

Main Cases		
Class 5		
Nominal Vaule	Part #	Price
0.3 oz	189350	\$42.00
0.2 oz	194054	\$40.00
0.1 oz	194032	\$40.00
0.05 oz	189234	\$42.00
0.5 lb	189635	\$38.50
0.3 lb	189644	\$38.50
0.2 lb	190126	\$38.50
0.1 lb	189506	\$42.00
0.05 lb	190126	\$38.50
0.03 lb	189476	\$42.00
0.02 lb	189350	\$42.00
0.01 lb	194031	\$155.00
0.005 lb	Consult	Consult
0.003 lb	Consult	Consult
0.002 lb	Consult	Consult
0.001 lb	Consult	Consult

Accessories

Description	Part #	Price
Statement of Accuracy	36092	\$47.50
Serial number	25836	\$17.00

STAINLESS STEEL / METRIC SETS

RANGE: 5 g and 50 g

ASTM

Class 5

Optional Certificate

Set Range	Part #	Price	Accredited
5g - 1mg	12548	\$200.00	\$240.00
50g - 1mg	12504	\$250.00	\$475.00
50g - 10mg	12502	\$230.00	\$380.00
50g - 1g	12500	\$190.00	\$190.00
(2) 50g - 1mg	12550	\$365.00	\$475.00

Weight Set Contents

5g - 1mg	50g - 1mg	(2) 50g - 1mg	50g - 10mg	50g - 1g
12548	12504	12550	12502	12500
-	(1) 50 g	(2) 50 g	(1) 50 g	(1) 50 g
-	-	(1) 30 g	-	-
-	(2) 20 g	(1) 20 g	(2) 20 g	(2) 20 g
-	(1) 10 g	(1) 10 g	(1) 10 g	(1) 10 g
(1) 5 g	(1) 5 g	(1) 5 g	(1) 5 g	(1) 5 g
(1) 3 g	-	(1) 3 g	-	-
(1) 2 g	(2) 2 g	(1) 2 g	(2) 2 g	(2) 2 g
(1) 1 g	(1) 1 g	(1) 1 g	(1) 1 g	(1) 1 g
(1) 500 mg	(1) 500 mg	(1) 500 mg	(1) 500 mg	-
(1) 300 mg	-	(1) 300 mg	-	-
(1) 200 mg	(2) 200 mg	(1) 200 mg	(2) 200 mg	-
(1) 100 mg	(1) 100 mg	(1) 100 mg	(1) 100 mg	-
(1) 50 mg	(1) 50 mg	(1) 50 mg	(1) 50 mg	-
(1) 30 mg	-	(1) 30 mg	-	-
(1) 20 mg	(2) 20 mg	(1) 20 mg	(2) 20 mg	-
(1) 10 mg	(1) 10 mg	(1) 10 mg	(1) 10 mg	-
(1) 5 mg	(1) 5 mg	(1) 5 mg	-	-
(1) 3 mg	-	(1) 3 mg	-	-
(1) 2 mg	(2) 2 mg	(1) 2 mg	-	-
(1) 1 mg	(1) 1 mg	(1) 1 mg	-	-
16 pcs. 12.221g set wt.	20 pcs. 111.11g set wt.	21 pcs. 172.221g set wt.	16 pcs. 111.1g set wt.	8 pcs. 110.000 g set wt.



PN 12500 50 g to 1 g

Replacement Cases

Main Cases		
Class 5		
Set Range	Part #	Price
5g - 1mg	11510	\$37.50
50g - 1mg	11512	\$37.50
50g - 10mg	11512	\$37.50
50g - 1g	11512	\$37.50
(2) 50g - 1mg	11512	\$37.50

Inserts		
Class 5 (leaf weight cover not included)		
Set Range	Part #	Price
50g - 1mg	11517	\$37.50
50g - 10mg	11517	\$37.50
50g - 1g	11516	\$37.50

Accessories

Description	Part #	Price
Statement of Accuracy	36092	\$47.50
Leaf weight cover	11758	\$43.00
Tweezer	65640	\$21.00
Serial number	25836	\$17.00
Premium tweezer	152414	\$43.00

ASTM
PRECISION

OIML
PRECISION

BALANCE
CALIBRATION

STAINLESS
FIELD WEIGHTS

CAST IRON
FIELD WEIGHTS

ASTM
SPECIALTY

ACCESSORIES

STAINLESS STEEL / METRIC SETS

RANGE: 100 g

ASTM

Class 5

Set Range	Part #	Price	Optional Certificate Accredited
100 g - 1 mg	12510	\$265.00	\$505.00
100 g - 10 mg	12508	\$255.00	\$395.00
100 g - 1 g	12506	\$230.00	\$215.00

Weight Set Contents

100 g - 1 mg	100 g - 10 mg	100 g - 1 g
12510	12508	12506
(1) 100 g	(1) 100 g	(1) 100 g
(1) 50 g	(1) 50 g	(1) 50 g
(2) 20 g	(2) 20 g	(2) 20 g
(1) 10 g	(1) 10 g	(1) 10 g
(1) 5 g	(1) 5 g	(1) 5 g
(2) 2 g	(2) 2 g	(2) 2 g
(1) 1 g	(1) 1 g	(1) 1 g
(1) 500 mg	(1) 500 mg	
(2) 200 mg	(2) 200 mg	
(1) 100 mg	(1) 100 mg	
(1) 50 mg	(1) 50 mg	
(2) 20 mg	(2) 20 mg	
(1) 10 mg	(1) 10 mg	
(1) 5 mg		
(2) 2 mg		
(1) 1 mg		
21 pcs. 211.11 g set wt.	17 pcs. 211.19 g set wt.	9 pcs. 210.000 g set wt.



PN 12506 100 g to 1 g

Replacement Cases

Main Cases		
Class 5		
Set Range	Part #	Price
100 g - 1 mg	11512	\$37.50
100 g - 10 mg	11512	\$37.50
100 g - 1 g	11512	\$37.50

Inserts		
Class 5 (leaf weight cover not included)		
Set Range	Part #	Price
100 g - 1 mg	11519	\$37.50
100 g - 10 mg	11519	\$37.50
100 g - 1 g	11518	\$37.50

Accessories

Description	Part #	Price
Statement of Accuracy	36092	\$47.50
Leaf weight cover	11758	\$43.00
Tweezer	65640	\$21.00
Serial number	25836	\$17.00
Premium tweezer	152414	\$43.00

RANGE: 500 g

ASTM

Class 5

Set Range	Part #	Price
500 g - 1mg	12516	\$490.00
500 g - 10 mg	12514	\$440.00
500 g - 1g	12512	\$390.00

Optional Certificate

Accredited
\$605.00
\$505.00
\$310.00

Weight Set Contents

500 g - 1mg	500 g - 10 mg	500 g - 1g
12516	12514	12512
(1) 500 g	(1) 500 g	(1) 500 g
(2) 200 g	(2) 200 g	(2) 200 g
(1) 100 g	(1) 100 g	(1) 100 g
(1) 50 g	(1) 50 g	(1) 50 g
(2) 20 g	(2) 20 g	(2) 20 g
(1) 10 g	(1) 10 g	(1) 10 g
(1) 5 g	(1) 5 g	(1) 5 g
(2) 2 g	(2) 2 g	(2) 2 g
(1) 1 g	(1) 1 g	(1) 1 g
(1) 500 mg	(1) 500 mg	
(2) 200 mg	(2) 200 mg	
(1) 100 mg	(1) 100 mg	
(1) 50 mg	(1) 50 mg	
(2) 20 mg	(2) 20 mg	
(1) 10 mg	(1) 10 mg	
(1) 5 mg		
(2) 2 mg		
(1) 1 mg		
24 pcs. 1.11111 kg set wt.	20 pcs. 1.1111 kg set wt.	12 pcs. 1.110 kg set wt.



PN 12512 500 g to 1g

Replacement Cases

Main Cases		
Class 5		
Set Range	Part #	Price
500 g - 1mg	11520	\$73.00
500 g - 10 mg	11520	\$73.00
500 g - 1g	11520	\$73.00

Secondary Leatherette Case		
Class 5		
Set Range	Part #	Price
100 g - 1mg	11512	\$37.50
100 g - 10 mg	11512	\$37.50
100 g - 1g	11512	\$37.50

Inserts for Secondary Case		
Class 5 (leaf weight cover not included)		
Set Range	Part #	Price
100 g - 1mg	11519	\$37.50
100 g - 10 mg	11519	\$37.50
100 g - 1g	11518	\$37.50

Accessories

Description	Part #	Price
Statement of Accuracy	36092	\$47.50
Leaf weight cover	11758	\$43.00
Tweezer	65640	\$21.00
Serial number	25836	\$17.00
Premium tweezer	152414	\$43.00

ASTM
PRECISION

OIML
PRECISION

BALANCE
CALIBRATION

STAINLESS
FIELD WEIGHTS

CAST IRON
FIELD WEIGHTS

ASTM
SPECIALTY

ACCESSORIES

ASTM
PRECISIONOIML
PRECISIONBALANCE
CALIBRATIONSTAINLESS
FIELD WEIGHTSCAST IRON
FIELD WEIGHTSASTM
SPECIALTY

ACCESSORIES

STAINLESS STEEL / METRIC SETS

RANGE: 1kg

ASTM

Class 5

Set Range	Part #	Price	Optional Certificate Accredited
1kg - 1mg	12522	\$545.00	\$630.00
1kg - 10mg	12520	\$535.00	\$540.00
1kg - 1g	12518	\$500.00	\$350.00

Weight Set Contents

1kg - 1mg	1kg - 10mg	1kg - 1g
12522	12520	12518
(1) 1kg	(1) 1kg	(1) 1kg
(1) 500g	(1) 500g	(1) 500g
(2) 200g	(2) 200g	(2) 200g
(1) 100g	(1) 100g	(1) 100g
(1) 50g	(1) 50g	(1) 50g
(2) 20g	(2) 20g	(2) 20g
(1) 10g	(1) 10g	(1) 10g
(1) 5g	(1) 5g	(1) 5g
(2) 2g	(2) 2g	(2) 2g
(1) 1g	(1) 1g	(1) 1g
(1) 500mg	(1) 500mg	
(2) 200mg	(2) 200mg	
(1) 100mg	(1) 100mg	
(1) 50mg	(1) 50mg	
(2) 20mg	(2) 20mg	
(1) 10mg	(1) 10mg	
(1) 5mg		
(2) 2mg		
(1) 1mg		
25 pcs. 2.1111kg set wt.	21 pcs. 2.1111kg set wt.	13 pcs. 2.11kg set wt.



PN 12518 1kg to 1g

Replacement Cases

Main Cases			
Class 5			
Set Range	Part #	Price	
1kg - 1mg	11521	\$73.00	
1kg - 10mg	11521	\$73.00	
1kg - 1g	11521	\$73.00	

Secondary Leatherette Case			
Class 5			
Set Range	Part #	Price	
100g - 1mg	11512	\$37.50	
100g - 10mg	11512	\$37.50	
100g - 1g	11512	\$37.50	

Inserts			
Class 5 (leaf weight cover not included)			
Set Range	Part #	Price	
100g - 1mg	11519	\$37.50	
100g - 10mg	11519	\$37.50	
100g - 1g	11518	\$37.50	

Accessories

Description	Part #	Price
Statement of Accuracy	36092	\$47.50
Leaf weight cover	11758	\$43.00
Tweezer	65640	\$21.00
Serial number	25836	\$17.00
Premium tweezer	152414	\$43.00

RANGE: 2 kg

ASTM

Class 5			Optional Certificate
Set Range	Part #	Price	Accredited
2 kg - 1 mg	12528	\$660.00	\$640.00
(5) 2 kg - 1 mg	12534	\$1,040.00	\$818.00
2 kg - 10 mg	12526	\$625.00	\$590.00
(5) 2 kg - 10 mg	12532	\$1,040.00	\$730.00
2 kg - 1 g	12524	\$580.00	\$395.00
(5) 2 kg - 1 g	12530	\$965.00	\$565.00

Weight Set Contents

2 kg - 1 mg	(5) 2 kg - 1 mg	2 kg - 10 mg	(5) 2 kg - 10 mg	2 kg - 1 g	(5) 2 kg - 1 g
12528	12534	12526	12532	12524	12530
(1) 2 kg	(5) 2 kg	(1) 2 kg	(5) 2 kg	(1) 2 kg	(5) 2 kg
(1) 1 kg	-	(1) 1 kg	-	(1) 1 kg	-
(1) 500 g	(5) 500 g	(1) 500 g	(5) 500 g	(1) 500 g	(5) 500 g
(2) 200 g	(2) 200 g	(2) 200 g	(2) 200 g	(2) 200 g	(2) 200 g
(1) 100 g	(1) 100 g	(1) 100 g	(1) 100 g	(1) 100 g	(1) 100 g
(1) 50 g	(1) 50 g	(1) 50 g	(1) 50 g	(1) 50 g	(1) 50 g
(2) 20 g	(2) 20 g	(2) 20 g	(2) 20 g	(2) 20 g	(2) 20 g
(1) 10 g	(1) 10 g	(1) 10 g	(1) 10 g	(1) 10 g	(1) 10 g
(1) 5 g	(1) 5 g	(1) 5 g	(1) 5 g	(1) 5 g	(1) 5 g
(2) 2 g	(2) 2 g	(2) 2 g	(2) 2 g	(2) 2 g	(2) 2 g
(1) 1 g	(1) 1 g	(1) 1 g	(1) 1 g	(1) 1 g	(1) 1 g
(1) 500 mg	(1) 500 mg	(1) 500 mg	(1) 500 mg		
(2) 200 mg	(2) 200 mg	(2) 200 mg	(2) 200 mg		
(1) 100 mg	(1) 100 mg	(1) 100 mg	(1) 100 mg		
(1) 50 mg	(1) 50 mg	(1) 50 mg	(1) 50 mg		
(2) 20 mg	(2) 20 mg	(2) 20 mg	(2) 20 mg		
(1) 10 mg	(1) 10 mg	(1) 10 mg	(1) 10 mg		
(1) 5 mg	(1) 5 mg				
(2) 2 mg	(2) 2 mg				
(1) 1 mg	(1) 1 mg				
26 pc 4.11111 kg set wt.	33 pc 13.11111 kg set wt.	22 pc 4.1111 kg set wt.	29 pc 13.1111 kg set wt.	14 pc 4.110 kg set wt.	21 pc 13.11 kg set wt.



PN 12528 2 kg to 1 mg

Replacement Cases

Main Cases		
Class 5		
Set Range	Part #	Price
2 kg - 1 mg	11522	\$180.00
(5) 2 kg - 1 mg	11523	\$250.00
2 kg - 10 mg	11522	\$180.00
(5) 2 kg - 10 mg	11523	\$250.00
2 kg - 1 g	11522	\$180.00
(5) 2 kg - 1 g	11523	\$250.00

Secondary Leatherette Case		
Class 5		
Set Range	Part #	Price
100 g - 1 mg	11512	\$37.50
100 g - 10 mg	11512	\$37.50
100 g - 1 g	11512	\$37.50

Inserts		
Class 5 (leaf weight cover not included)		
Set Range	Part #	Price
100 g - 1 mg	11519	\$37.50
100 g - 10 mg	11519	\$37.50
100 g - 1 g	11518	\$37.50

Accessories

Description	Part #	Price
Statement of Accuracy	36092	\$47.50
Leaf weight cover	11758	\$43.00
Tweezer	65640	\$21.00
Serial number	25836	\$17.00
Premium tweezer	152414	\$43.00

ASTM
PRECISIONOIML
PRECISIONBALANCE
CALIBRATIONSTAINLESS
FIELD WEIGHTSCAST IRON
FIELD WEIGHTSASTM
SPECIALTY

ACCESSORIES

STAINLESS STEEL / METRIC SETS

RANGE: 5 kg

ASTM

Class 5			Optional Certificate
Set Range	Part #	Price	Accredited
5 kg - 1 mg	12537	\$890.00	\$780.00
(2) 5 kg - 1 mg	12542	\$1,320.00	\$800.00
5 kg - 10 mg	12536	\$825.00	\$680.00
(2) 5 kg - 10 mg	12539	\$1,160.00	\$710.00
5 kg - 1 g	12535	\$785.00	\$490.00
(2) 5 kg - 1 g	12538	\$1,130.00	\$520.00
(3) 5 kg	12562	\$995.00	\$220.00

Weight Set Contents

5 kg - 1 mg	(2) 5 kg - 1 mg	5 kg - 10 mg	(2) 5 kg - 10 mg	5 kg - 1 g	(2) 5 kg - 1 g	(3) 5 kg
12537	12542	12536	12539	12535	12538	12562
(1) 5 kg	(2) 5 kg	(1) 5 kg	(2) 5 kg	(1) 5 kg	(2) 5 kg	(3) 5 kg
(2) 2 kg	(2) 2 kg	(2) 2 kg	(2) 2 kg	(2) 2 kg	(2) 2 kg	
(1) 1 kg	(1) 1 kg	(1) 1 kg	(1) 1 kg	(1) 1 kg	(1) 1 kg	
(1) 500 g	(5) 500 g	(1) 500 g	(5) 500 g	(1) 500 g	(5) 500 g	
(2) 200 g	(2) 200 g	(2) 200 g	(2) 200 g	(2) 200 g	(2) 200 g	
(1) 100 g	(1) 100 g	(1) 100 g	(1) 100 g	(1) 100 g	(1) 100 g	
(1) 50 g	(1) 50 g	(1) 50 g	(1) 50 g	(1) 50 g	(1) 50 g	
(2) 20 g	(2) 20 g	(2) 20 g	(2) 20 g	(2) 20 g	(2) 20 g	
(1) 10 g	(1) 10 g	(1) 10 g	(1) 10 g	(1) 10 g	(1) 10 g	
(1) 5 g	(1) 5 g	(1) 5 g	(1) 5 g	(1) 5 g	(1) 5 g	
(2) 2 g	(2) 2 g	(2) 2 g	(2) 2 g	(2) 2 g	(2) 2 g	
(1) 1 g	(1) 1 g	(1) 1 g	(1) 1 g	(1) 1 g	(1) 1 g	
(1) 500 mg	(1) 500 mg	(1) 500 mg	(1) 500 mg	(1) 500 mg		
(2) 200 mg	(2) 200 mg	(2) 200 mg	(2) 200 mg	(2) 200 mg		
(1) 100 mg	(1) 100 mg	(1) 100 mg	(1) 100 mg	(1) 100 mg		
(1) 50 mg	(1) 50 mg	(1) 50 mg	(1) 50 mg	(1) 50 mg		
(2) 20 mg	(2) 20 mg	(2) 20 mg	(2) 20 mg	(2) 20 mg		
(1) 10 mg	(1) 10 mg	(1) 10 mg	(1) 10 mg	(1) 10 mg		
(1) 5 mg	(1) 5 mg					
(2) 2 mg	(2) 2 mg					
(1) 1 mg	(1) 1 mg					
28 pcs. 11.11 kg set wt.	33 pcs. 18.11 kg set wt.	24 pcs. 11.1111 kg set wt.	29 pcs. 18.1111 kg set wt.	16 pcs. 11.11 kg set wt.	21 pcs. 18.110 kg set wt.	3 pcs. 15 kg set wt.



PN 12542 (2) 5 kg to 1 mg

Replacement Cases

Main Cases		
Class 5		
Set Range	Part #	Price
5 kg - 1 mg	11524	\$250.00
(2) 5 kg - 1 mg	11525	\$250.00
5 kg - 10 mg	11524	\$250.00
(2) 5 kg - 10 mg	11525	\$250.00
5 kg - 1 g	11524	\$250.00
(2) 5 kg - 1 g	11525	\$250.00
(3) 5 kg	11558	\$250.00

Secondary Leatherette Case		
Class 5		
Set Range	Part #	Price
100 g - 1 mg	11512	\$37.50
100 g - 10 mg	11512	\$37.50
100 g - 1 g	11512	\$37.50

Inserts		
Class 5 (leaf weight cover not included)		
Set Range	Part #	Price
100 g - 1 mg	11519	\$37.50
100 g - 10 mg	11519	\$37.50
100 g - 1 g	11518	\$37.50

Accessories

Description	Part #	Price
Statement of Accuracy	36092	\$47.50
Leaf weight cover	11758	\$43.00
Tweezer	65640	\$21.00
Serial number	25836	\$17.00
Premium tweezer	152414	\$43.00

100

An ISO 9001 Registered Company ©2022 Rice Lake Weighing Systems 7122
Prices and specifications subject to change without notice. Visit ricelake.com for current prices.

RANGE: 4 oz

ASTM

Class 5

Optional Certificate

Set Range	Part #	Price	Accredited
4 oz - 1/32 oz	12623	\$215.00	\$215.00
4 oz - 0.05 oz	12625	\$235.00	\$195.00
0.2 lb - 0.001lb	12576	\$225.00	\$260.00
0.3 lb - 0.001lb	12654	\$505.00	\$260.00

Weight Set Contents

4 oz - 1/32 oz	4 oz - 0.05 oz	0.2 lb - 0.001lb	0.3 lb - 0.001lb
12623	12625	12576	12654
(1) 4 oz	(1) 4 oz	-	(1) 0.3 lb
(1) 2 oz	(1) 2 oz	(2) 0.2 lb	(1) 0.2 lb
(1) 1 oz	(1) 1 oz	(1) 0.1 lb	(1) 0.1 lb
(1) 1/2 oz	(1) 0.5 oz	(1) 0.05 lb	(1) 0.05 lb
(1) 1/4 oz	(1) 0.2 oz	-	(1) 0.03 lb
(1) 1/8 oz	(1) 0.1 oz	(2) 0.02 lb	(1) 0.02 lb
(1) 1/16 oz	(1) 0.05 oz	(1) 0.01 lb	(1) 0.01 lb
(2) 1/32 oz		(1) 0.005 lb	(1) 0.005 lb
		-	(1) 0.003 lb
		(2) 0.002 lb	(1) 0.002 lb
		(1) 0.001 lb	(1) 0.001 lb
9 pcs. 1/2 lb set wt.	8 pcs. 1 lb 0.05 oz set wt.	11 pcs. 0.61 lb set wt.	11 pcs. 0.722 lb set wt.



PN 12623 4 oz to 1/32 oz

Replacement Cases

Main Cases		
Class 5		
Set Size	Part #	Price
4 oz - 1/32 oz	11510	\$37.50
4 oz - 0.05 oz	11510	\$37.50
0.2 lb - 0.001lb	11512	\$37.50
0.3 lb - 0.001lb	200180	\$40.00

Inserts		
Class 5		
Size	Part #	Price
4 oz - 1/32 oz	11552	\$26.50
4 oz - 0.05 oz	11553	\$26.50
0.2 oz - 0.001lb	200160	\$40.00

Accessories

Description	Part #	Price
Statement of Accuracy	36092	\$47.50
Serial number	25836	\$17.00

ASTM
PRECISION

OIML
PRECISION

BALANCE
CALIBRATION

STAINLESS
FIELD WEIGHTS

CAST IRON
FIELD WEIGHTS

ASTM
SPECIALTY

ACCESSORIES

ASTM
PRECISIONOIML
PRECISIONBALANCE
CALIBRATIONSTAINLESS
FIELD WEIGHTSCAST IRON
FIELD WEIGHTSASTM
SPECIALTY

ACCESSORIES

STAINLESS STEEL / AVOIRDUPOIS SET

RANGE: 1lb

ASTM

Class 5

Optional Certificate

Set Range	Part #	Price	Accredited
1lb - 1/32 oz (fractional)	12591	\$345.00	\$280.00
1lb - 0.001lb (decimal)	12593	\$405.00	\$330.00
1lb - 0.05 oz (combination)	12595	\$370.00	\$255.00

Weight Set Contents

1lb - 1/32 oz	1lb - 0.001lb	1lb - 0.05 oz
12591	12593	12595
(1) 1lb	(1) 1lb	(1) 1lb
(1) 8 oz	(1) 0.5 lb	(1) 8 oz
(1) 4 oz	(2) 0.2 lb	(1) 4 oz
(1) 2 oz	(1) 0.1lb	(1) 2 oz
(1) 1oz	(1) 0.05 lb	(1) 1oz
(1) 1/2 oz	(2) 0.02 lb	(1) 0.5 oz
(1) 1/4 oz	(1) 0.01lb	(2) 0.2 oz
(1) 1/8 oz	(1) 0.005 lb	(1) 0.1 oz
(1) 1/16 oz	(2) 0.002 lb	(1) 0.05 oz
(2) 1/32 oz	(1) 0.001lb	
11 pcs. 2 lb set wt.	13 pcs. 2.1110 lb set wt.	10 pcs. 1.990625 lb set wt.



PN 12591 1 lb to 1/32 oz

Replacement Cases

Main Cases			
Class 5			
Set Range	Part #	Price	
1lb - 1/32 oz (fractional)	11544	\$79.00	
1lb - 0.001lb (decimal)	11544	\$79.00	
1lb - 0.05 oz (combination)	11544	\$79.00	

Secondary Leatherette Cases			
Class 5			
Set Range	Part #	Price	
1lb - 1/32 oz	11510	\$37.50	
1lb - 0.001lb	11512	\$37.50	
1lb - 0.05 oz	11510	\$37.50	

Inserts			
Class 5			
Set Range	Part #	Price	
1lb - 1/32 oz	11552	\$26.50	
1lb - 0.001lb	11553	\$26.50	
1lb - 0.05 oz	200160	\$40.00	

Accessories

Description	Part #	Price
Statement of Accuracy	36092	\$47.50
Serial number	25836	\$17.00

RANGE: 2 lb

ASTM

Class 5

Set Size	Part #	Price
2 lb - 1/32 oz (fractional)	12597	\$455.00
(2) 2 lb - 1/32 oz (fractional)	12603	\$590.00
2 lb - 0.001 lb (decimal)	12599	\$470.00
(2) 2 lb - 0.001 lb (decimal)	12605	\$590.00
2 lb - 0.05 oz (decimal)	12601	\$500.00
(2) 2 lb - 0.05 oz (decimal)	12607	\$590.00

Optional Certificate

Accredited
\$325.00
\$365.00
\$365.00
\$415.00
\$270.00
\$310.00

Weight Set Contents

2 lb - 1/32 oz	(2) 2 lb - 1/32 oz	2 lb - 0.001 lb	(2) 2 lb - 0.001 lb	2 lb - 0.05 oz	(2) 2 lb - 0.05 oz
12597	12603	12599	12605	12601	12607
(1) 2 lb	(2) 2 lb	(1) 2 lb	(2) 2 lb	(1) 2 lb	(2) 2 lb
(1) 1 lb	(1) 1 lb	(1) 1 lb	(1) 1 lb	(1) 1 lb	(1) 1 lb
(1) 8 oz	(1) 8 oz	(1) 0.5 lb	(1) 0.5 lb	(1) 8 oz	(1) 8 oz
(1) 4 oz	(1) 4 oz	(2) 0.2 lb	(2) 0.2 lb	(1) 4 oz	(1) 4 oz
(1) 2 oz	(1) 2 oz	(1) 0.1 lb	(1) 0.1 lb	(1) 2 oz	(1) 2 oz
(1) 1 oz	(1) 1 oz	(1) 0.05 lb	(1) 0.05 lb	(1) 1 oz	(1) 1 oz
(1) 1/2 oz	(1) 1/2 oz	(2) 0.02 lb	(2) 0.02 lb	(1) 0.5 oz	(1) 0.5 oz
(1) 1/4 oz	(1) 1/4 oz	(1) 0.01 lb	(1) 0.01 lb	(2) 0.2 oz	(2) 0.2 oz
(1) 1/8 oz	(1) 1/8 oz	(1) 0.005 lb	(1) 0.005 lb	(1) 0.1 oz	(1) 0.1 oz
(1) 1/16 oz	(1) 1/16 oz	(2) 0.002 lb	(2) 0.002 lb	(1) 0.05 oz	(1) 0.05 oz
(2) 1/32 oz	(2) 1/32 oz	(1) 0.001 lb	(1) 0.001 lb		
12 pcs. 4 lb set wt.	13 pcs. 6 lb set wt.	14 pcs. 4.108 lb set wt.	15 pcs. 6.1100 lb set wt.	11 pcs. 4.7875 lb set wt.	12 pcs. 6 lb 0.05 oz set wt.



PN 12599 2 lb - 0.001 lb

Replacement Cases

Main Cases		
Class 5		
Set Size	Part #	Price
2 lb - 1/32 oz (fractional)	11547	\$79.00
(2) 2 lb - 1/32 oz (fractional)	11548	\$79.00
2 lb - 0.001 lb (decimal)	11547	\$79.00
(2) 2 lb - 0.001 lb (decimal)	11548	\$79.00
2 lb - 0.05 oz (decimal)	11547	\$79.00
(2) 2 lb - 0.05 oz (decimal)	11548	\$79.00

Secondary Leatherette Cases		
Class 5		
Size	Part #	Price
4 oz - 1/32 oz	11510	\$37.50
0.2 lb - 0.001 lb	11512	\$37.50
4 oz - 0.05 oz	11510	\$37.50

Inserts		
Class 5		
Size	Part #	Price
2 lb - 1/32 oz	11552	\$26.50
2 lb - 0.001 lb	11553	\$26.50
2 lb - 0.05 oz	200160	\$40.00

Accessories

Description	Part #	Price
Statement of Accuracy	36092	\$47.50
Serial number	25836	\$17.00

ASTM
PRECISION

OIML
PRECISION

BALANCE
CALIBRATION

STAINLESS
FIELD WEIGHTS

CAST IRON
FIELD WEIGHTS

ASTM
SPECIALTY

ACCESSORIES

RANGE: 5 lb

ASTM
PRECISION

OIML
PRECISION

BALANCE
CALIBRATION

STAINLESS
FIELD WEIGHTS

CAST IRON
FIELD WEIGHTS

ASTM
SPECIALTY

ACCESSORIES

ASTM

Class 5

Optional Certificate

Set Range	Part #	Price	Accredited
5 lb - 1/32 oz	12615	\$580.00	\$410.00
(5) 5 lb - 1/32 oz	12579	\$1,190.00	\$700.00
5 lb - 0.001 lb	12617	\$585.00	\$460.00
(5) 5 lb - 0.001 lb (combination)	12582	\$1,220.00	\$755.00
(5) 5 lb - 0.001 lb	12634	\$1,220.00	\$755.00
5 lb - 0.05 oz (combination)	12619	\$600.00	\$385.00
(5) 5 lb - 0.05 oz (combination)	12636	\$1,150.00	\$650.00
(3) 5 lb - 1 gr (21 lb fractional U.S. Postal Service)	12627	\$1,210.00	\$790.00
(5) 5 lb - 1 gr (31 lb 55 gr)	12661	\$1,390.00	\$920.00
5 lb x (6) (30 lb)	12640	\$1,070.00	\$470.00

Weight Set Contents

5 lb - 1/32 oz	(5) 5 lb - 1/32 oz	5 lb - 0.001 lb	(5) 5 lb - 0.001 lb	(5) 5 lb - 0.001 lb	5 lb - 0.05 oz	(5) 5 lb - 0.05 oz
12615	12579	12617	12582	12634	12619	12636
(1) 5 lb	(5) 5 lb	(1) 5 lb	(5) 5 lb	(5) 5 lb	(1) 5 lb	(5) 5 lb
(2) 2 lb	-	(2) 2 lb	-	-	(2) 2 lb	-
(1) 1 lb	(5) 1 lb	(1) 1 lb	(5) 1 lb	(5) 1 lb	(1) 1 lb	(5) 1 lb
(1) 8 oz	(1) 8 oz	(1) 0.5 lb	(1) 8 oz	(1) 0.5 lb	(1) 8 oz	(1) 8 oz
(1) 4 oz	(1) 4 oz	(2) 0.2 lb	(1) 4 oz	(2) 0.2 lb	(1) 4 oz	(1) 4 oz
(1) 2 oz	(1) 2 oz	(1) 0.1 lb	(2) 0.2 lb	(1) 0.1 lb	(1) 2 oz	(1) 2 oz
(1) 1 oz	(1) 1 oz	(1) 0.05 lb	(1) 2 oz	(1) 0.05 lb	(1) 1 oz	(1) 1 oz
(1) 1/2 oz	(1) 1/2 oz	(2) 0.02 lb	(1) 0.1 lb	(2) 0.02 lb	(1) 0.5 oz	(1) 0.5 oz
(1) 1/4 oz	(1) 1/4 oz	(1) 0.01 lb	(1) 1 oz	(1) 0.01 lb	(2) 0.2 oz	(2) 0.2 oz
(1) 1/8 oz	(1) 1/8 oz	(1) 0.005 lb	(1) 0.05 lb	(1) 0.005 lb	(1) 0.1 oz	(1) 0.05 oz
(1) 1/16 oz	(1) 1/16 oz	(2) 0.002 lb	(1) 1/2 oz	(2) 0.002 lb	(1) 0.05 oz	
(2) 1/32 oz	(2) 1/32 oz	(1) 0.001 lb	(2) 0.02 lb	(1) 0.001 lb		
			(1) 1/4 oz			
			(1) 0.01 lb			
			(1) 1/8 oz			
			(1) 0.005 lb			
			(1) 1/16 oz			
			(2) 0.002 lb			
			(2) 1/32 oz			
			(1) 0.001 lb			
14 pcs. 11 lb set wt.	20 pcs. 31 lb set wt.	16 pcs. 11.11 lb set wt.	31 pcs. 31.61 lb set wt.	22 pcs. 31.11 lb set wt.	13 pcs. 11 lb 0.05 oz set wt.	18 pcs. 31 lb 0.05 oz set wt.

Replacement Cases

Main Cases		
Class 5		
Set Range	Part #	Price
5 lb - 1/32 oz	11550	\$245.00
(5) 5 lb - 1/32 oz	11542	\$245.00
5 lb - 0.001 lb	11550	\$245.00
(5) 5 lb - 0.001 lb (combination)	11542	\$245.00
(5) 5 lb - 0.001 lb	11542	\$245.00
5 lb - 0.05 oz (combination)	11550	\$245.00
5 lb - 0.05 oz (combination)	11542	\$245.00
(3) 5 lb - 1 gr (21 lb fractional U.S. Postal Service)	11554	\$245.00

Main Cases		
Class 5		
Set Range	Part #	Price
(5) 5 lb - 1 gr (31 lb 55 gr)	11570	\$245.00
5 lb x (6) (30 lb)	11559	\$245.00

Secondary Leatherette Cases		
Class 5		
Set Range	Part #	Price
5 lb - 1/32 oz	11510	\$37.50
(5) 5 lb - 1/32 oz	11510	\$37.50
5 lb - 0.001 lb	11512	\$37.50

Secondary Leatherette Cases		
Class 5		
Set Range	Part #	Price
(5) 5 lb - 0.001 lb (combination)	11510 and 11512	\$37.50
(5) 5 lb - 0.001 lb	11512	\$37.50
5 lb - 0.05 oz	11510	\$37.50
(5) 5 lb - 0.05 oz	11510	\$37.50
(3) 5 lb - 1 gr	11510	\$37.50

(3) 5 lb - 1 gr	(5) 5 lb - 1 gr	(6) 5 lb
12627	12661	12640
(3) 5 lb	(5) 5 lb	(6) 5 lb
(5) 1 lb	(5) 1 lb	
(1) 8 oz	(1) 8 oz	
(1) 4 oz	(1) 4 oz	
(1) 2 oz	(1) 2 oz	
(1) 1 oz	(1) 1 oz	
(1) 1/2 oz	(1) 1/2 oz	
(1) 1/4 oz	(1) 1/4 oz	
(1) 1/8 oz	(1) 1/8 oz	
(1) 1/16 oz	(1) 1/16 oz	
(2) 1/32 oz	(2) 1/32 oz	
(2) 10 gr	(1) 20 gr	
(2) 5 gr	(2) 10 gr	
(2) 2 gr	(2) 5 gr	
(1) 1 gr	(2) 2 gr	
	(1) 1 gr	
25 pcs. 21lb 55gr set wt.	28 pcs. 31lb 55gr set wt.	6 pcs. 30 lb set wt.



PN 12582 5 lb to 0.001 lb

Accessories

Inserts		
Class 5		
Size	Part #	Price
5 lb - 1/32 oz	11552	\$26.50
(5) 5 lb - 1/32 oz	11552	\$26.50
5 lb - 0.001lb	200160	\$40.00
(5) 5 lb - 0.001lb (combination)	200160	\$40.00
(5) 5 lb - 0.001lb	200160	\$40.00
5 lb - 0.05 oz	11553	\$26.50
(5) 5 lb - 0.05 oz	11553	\$26.50
(3) 5 lb - 1 gr	11552	\$26.50

Description	Part #	Price
Statement of Accuracy	36092	\$47.50
Serial number	25836	\$17.00

STAINLESS STEEL / AVOIRDUPOIS SET

RANGE: 10 lb

ASTM
PRECISION

OIML
PRECISION

BALANCE
CALIBRATION

STAINLESS
FIELD WEIGHTS

CAST IRON
FIELD WEIGHTS

ASTM
SPECIALTY

ACCESSORIES

ASTM

Set Range	Part #	Price	Optional Certificate	
				Accredited
(3) 10 lb	12638	\$925.00		\$235.00
10 lb - 1/32 oz	12609	\$845.00		\$465.00
10 lb - 0.001lb	12611	\$830.00		\$510.00
10 lb - 0.05 oz (21lb x 0.05 oz)	12613	\$900.00		\$415.00
10 lb - 1/4 oz	12573	\$1,310.00		\$475.00
10 lb - 1/32 oz	12642	\$1,210.00		\$465.00
10 lb - 0.001lb	12588	\$1,450.00		\$780.00
10 lb - 0.001lb	12644	\$1,150.00		\$510.00
10 lb - 0.001lb (combination)	12648	\$1,370.00		\$555.00
10 lb - 0.05 oz (combination)	12646	\$1,300.00		\$415.00
10 lb - 1/32 oz	12628	\$1,570.00		\$755.00
10 lb - 0.001lb	12621	\$1,720.00		\$800.00
10 lb - 0.05 oz (combination)	12632	\$1,750.00		\$725.00
10 lb - 0.001lb (51.61lb combination)	12650	\$1,770.00		\$800.00

Weight Set Contents

(3) 10 lb	10 lb - 1/32 oz	10 lb - 0.001lb	10 lb - 0.05 oz	10 lb - 1/4 oz	10 lb - 1/32 oz	10 lb - 0.001lb	10 lb - 0.001lb	10 lb - 0.001lb
12638	12609	12611	12613	12573	12642	12588	12644	12648
(3) 10 lb	(1) 10 lb (1) 5 lb (2) 2 lb (1) 1 lb (1) 8 oz (1) 4 oz (1) 2 oz (1) 1 oz (1) 1/2 oz (1) 1/4 oz (1) 1/8 oz (1) 1/16 oz (2) 1/32 oz	(1) 10 lb (1) 5 lb (2) 2 lb (1) 1 lb (1) 0.5 lb (2) 0.2 lb (1) 0.1 lb (1) 0.05 lb (2) 0.02 lb (1) 0.01 lb (1) 0.005 lb (2) 0.002 lb (1) 0.001 lb	(1) 10 lb (1) 5 lb (2) 2 lb (1) 1 lb (1) 8 oz (1) 4 oz (1) 2 oz (1) 1 oz (1) 0.5 oz (1) 0.2 oz (1) 0.1 oz (1) 0.05 oz	(2) 10 lb (1) 5 lb (5) 1 lb (3) 4 oz (3) 1 oz (2) 1/2 oz (2) 1/4 oz	(2) 10 lb (1) 5 lb (2) 2 lb (1) 1 lb (1) 8 oz (1) 4 oz (1) 2 oz (1) 1 oz (1) 1/2 oz (1) 1/4 oz (1) 1/8 oz (1) 1/16 oz (2) 1/32 oz	(2) 10 lb (1) 5 lb (5) 1 lb (3) 4 oz (2) 0.2 lb (1) 0.1 lb (3) 1 oz (1) 0.05 lb (2) 1/2 oz (2) 0.02 lb (2) 1/4 oz (1) 0.01 lb (1) 0.005 lb (2) 0.002 lb (1) 0.001 lb	(2) 10 lb (1) 5 lb (2) 2 lb (1) 1 lb (1) 0.5 lb (2) 0.2 lb (1) 0.1 lb (1) 0.05 lb (2) 0.02 lb (1) 0.01 lb (1) 0.005 lb (2) 0.002 lb (1) 0.001 lb	(2) 10 lb (1) 5 lb (2) 2 lb (1) 1 lb (1) 8 oz (1) 4 oz (1) 2 oz (1) 1 oz (1) 1/2 oz (1) 1/4 oz (1) 1/8 oz (1) 1/16 oz (2) 1/32 oz (2) 0.2 lb (1) 0.1 lb (1) 0.05 lb (2) 0.02 lb (1) 0.01 lb (1) 0.005 lb (2) 0.002 lb (1) 0.001 lb
3 pcs. 30lb set wt.	15 pcs. 21lb set wt.	17 pcs. 21.11lb set wt.	13 pcs. 21lb 0.05oz set wt.	18 pcs. 31lb 1/2 oz set wt.	16 pcs. 31lb set wt.	29 pcs. 31lb 1/2 oz set wt.	18 pcs. 31.1100 lb set wt.	27 pcs. 31lb set wt.

Replacement Cases

Main Cases		
Class 5		
Set Range	Part #	Price
(3) 10 lb	11558	\$250.00
10 lb - 1/32 oz	11549	\$245.00
10 lb - 0.001lb	11549	\$245.00
10 lb - 0.05 oz (21lb x 0.05 oz)	11549	\$245.00
10 lb - 1/4 oz	11540	\$245.00
10 lb - 1/32 oz	11562	\$245.00
10 lb - 0.001lb	11543	\$245.00
10 lb - 0.001lb	11562	\$245.00

Main Cases		
Class 5		
Set Range	Part #	Price
10 lb - 0.001lb (combination)	11562	\$245.00
10 lb - 0.05 oz (combination)	11562	\$245.00
10 lb - 1/32 oz	11555	\$245.00
10 lb - 0.001lb	11555	\$245.00
10 lb - 0.05 oz (combination)	11555	\$245.00
10 lb - 0.001lb (combination)	11563	\$245.00

Secondary Leatherette Cases		
Class 5		
Size	Part #	Price
10 lb - 0.001lb	11512	\$37.50
10 lb - 1/32 oz	11510	\$37.50

Inserts		
Class 5		
Size	Part #	Price
10 lb - 0.001lb	200160	\$40.00
10 lb - 1/32 oz	11552	\$26.50
10 lb - 0.05 oz	11553	\$26.50

STAINLESS STEEL / AVOIRDUPOIS SET

RANGE: 10 lb



ASTM
PRECISION

OIML
PRECISION

BALANCE
CALIBRATION

STAINLESS
FIELD WEIGHTS

CAST IRON
FIELD WEIGHTS

ASTM
SPECIALTY

ACCESSORIES

10 lb - 0.05 oz	10 lb - 1/32 oz	10 lb - 0.001 lb	10 lb - 0.05 oz	10 lb - 0.001 lb
12646	12628	12621	12632	12650
(2) 10 lb	(3) 10 lb	(3) 10 lb	(3) 10 lb	(3) 10 lb
(1) 5 lb	(3) 5 lb	(3) 5 lb	(3) 5 lb	(3) 5 lb
(2) 2 lb	—	—	—	—
(1) 1 lb	(5) 1 lb	(5) 1 lb	(5) 1 lb	(5) 1 lb
(1) 8 oz	(1) 8 oz	(1) 0.5 lb	(1) 8 oz	(1) 8 oz
(1) 4 oz	(1) 4 oz	(2) 0.2 lb	(1) 4 oz	(1) 4 oz
(1) 2 oz	(1) 2 oz	(1) 0.1 lb	(1) 2 oz	(2) 0.2 lb
(1) 1 oz	(1) 1 oz	(1) 0.05 lb	(1) 1 oz	(1) 2 oz
(1) 0.5 oz	(1) 1/2 oz	(2) 0.02 lb	(1) 0.5 oz	(1) 0.1 lb
(2) 0.2 oz	(1) 1/4 oz	(1) 0.01 lb	(2) 0.20 oz	(1) 1 oz
(1) 0.1 oz	(1) 1/8 oz	(1) 0.005 lb	(1) 0.1 oz	(1) 0.05 lb
(1) 0.05 oz	(1) 1/16 oz	(2) 0.002 lb	(1) 0.05 oz	(1) 1/2 oz
	(2) 1/32 oz	(1) 0.001 lb		(2) 0.02 lb
				(1) 1/4 oz
				(1) 0.01 lb
				(1) 1/8 oz
				(1) 0.005 lb
				(1) 1/16 oz
				(2) 0.002 lb
				(2) 1/32 oz
				(1) 0.001 lb
15 pcs. 31lb 0.05oz set wt.	21 pcs. 51lb set wt.	23 pcs. 51.11lb set wt.	20 pcs. 51lb 0.05oz set wt.	32 pcs. 51.6100 lb set wt.

Accessories

Description	Part #	Price
Statement of Accuracy	36092	\$47.50
Leaf weight cover	11758	\$43.00
Tweezer	65640	\$21.00
Serial number	25836	\$17.00
Premium tweezer	152414	\$43.00

ASTM

Cast Iron Field Weights

Applications:

Field standards for testing industrial devices Class III, Class III L or Class III I

Testing for non-marked scales without class designation

Verifying scales are within specified accuracy and tolerances

Styles Available:

- Grip-handle design for easy handling
- Nesting slab weights for heavy-capacity weighing
- Slotted weights and hangers for suspended weighing
- Counterpoise weights for ratio weighing

Features:

- Nominal value marked on weight
- Weight capacities of 10 kg/20 lb and up meet NIST Handbook 105-1 and Handbook 44 specifications
- Metric weights designated by gold paint
- Avoirdupois (pound) weights designated by silver paint
- Serial numbers may be stamped on weights (optional)



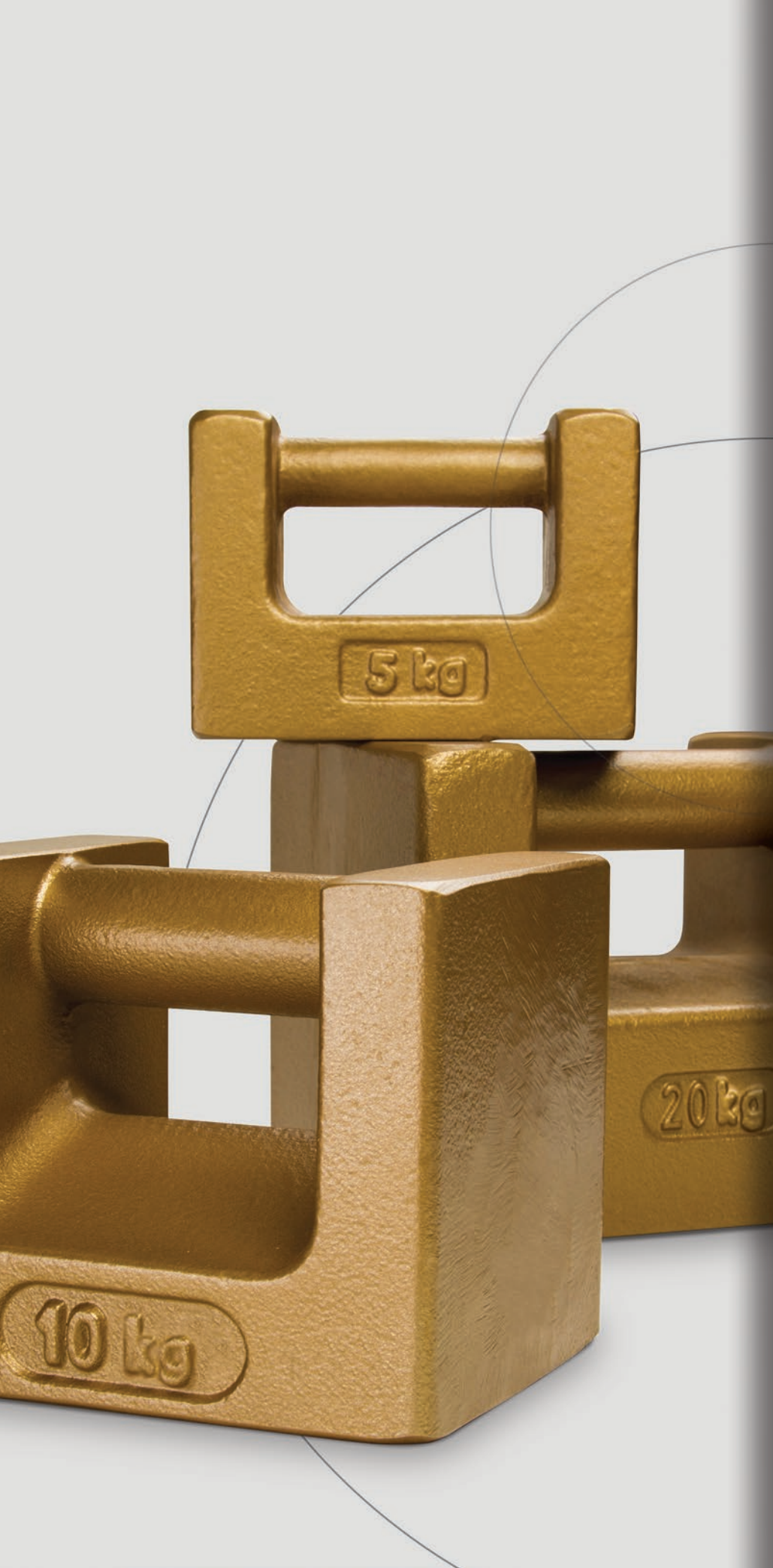

Grip-handle and Nesting Slab

110 Range: 3,000 lb – 1 lb

Grip-handle

111 Range: 1,000 kg – 500 g

Slotted Interlocking and Hanger

112 Range: 100 lb – 200 g

Counterpoise and Hanger Weights

113 Range: 200 kg – 7 oz

Avoirdupois Counterpoise and Hanger

114 Range: 500 lb – 7 oz

CAST IRON / GRIP-HANDLE AND NESTING SLAB

RANGE: 3,000 lb – 1 lb

ASTM

Class 6

Grip-handle

Weight	Part #	Length	Width	Height	Slot Width	Slot Depth*	Price	Optional Certificate	
								Accredited	
3,000 lb	12872	20-3/4 in (527 mm)	20-3/4 in (527 mm)	29 in (737 mm)	3-1/2 in (89 mm)	2-3/4 in (70 mm)	\$9,900.00		\$310.00
2,500 lb	12854	20-3/4 in (527 mm)	20-3/4 in (527 mm)	24-3/4 in (629 mm)	3-31/32 in (101 mm)	2-3/4 in (70 mm)	\$8,900.00		\$235.00
2,000 lb	12868	20-3/4 in (527 mm)	20-3/4 in (527 mm)	19-1/2 in (495 mm)	3-1/2 in (89 mm)	2-3/4 in (70 mm)	\$7,850.00		\$235.00
1,500 lb	12864	15-1/8 in (384 mm)	15-1/8 in (384 mm)	26-7/8 in (683 mm)	2-1/2 in (64 mm)	2-1/4 in (57 mm)	\$7,125.00		\$235.00
1,250 lb	12858	15 in (381 mm)	15 in (381 mm)	23-3/4 in (603 mm)	2-1/2 in (64 mm)	2-1/4 in (57 mm)	\$5,950.00		\$235.00
1,000 lb	12850	15-1/2 in (394 mm)	15 in (381 mm)	18-11/16 in (478 mm)	2-3/4 in (70 mm)	2-29/32 in (74 mm)	\$2,850.00		\$235.00
500 lb	12844	12 in (305 mm)	11-1/2 in (292 mm)	15-3/4 in (400 mm)	2-1/2 in (64 mm)	1-29/32 in (48 mm)	\$1,790.00		\$235.00
250 lb	12892	9-3/4 in (248 mm)	9-3/4 in (248 mm)	12 in (305 mm)	2-1/2 in (64 mm)	2 in (51 mm)	\$1,640.00		\$235.00
200 lb	12890	9-3/4 in (248 mm)	9-3/4 in (248 mm)	10 in (254 mm)	2-1/2 in (64 mm)	2 in (51 mm)	\$1,430.00		\$235.00
100 lb	12862	7 in (178 mm)	9-1/8 in (232 mm)	7-7/8 in (200 mm)	4-1/2 in (114 mm)	1-1/2 in (38 mm)	\$625.00		\$105.00
50 lb	12839	5-1/2 in (140 mm)	7-29/32 in (201 mm)	6-9/16 in (167 mm)	4-1/2 in (114 mm)	1-21/32 in (42 mm)	\$150.00		\$80.00
30 lb	12878	4-29/32 in (125 mm)	8-1/4 in (210 mm)	4-1/2 in (114 mm)	4-15/32 in (114 mm)	31/32 in (25 mm)	\$200.00		\$80.00
25 lb	12833	4-1/2 in (114 mm)	6-1/2 in (165 mm)	4-15/16 in (125 mm)	3-5/8 in (92 mm)	31/32 in (25 mm)	\$135.00		\$80.00
20 lb	12870	4-15/32 in (114 mm)	5-3/4 in (146 mm)	5-3/32 in (129 mm)	3-31/32 in (101 mm)	1-5/32 in (29 mm)	\$105.00		\$80.00

Class 7

Optional Certificate

Weight	Part #	Length	Width	Height	Price	Optional Certificate	
						Accredited	
10 lb	12828	3-1/4 in (83 mm)	5 in (127 mm)	4-1/32 in (102 mm)	\$82.00		\$80.00
5 lb	12823	2-9/16 in (65 mm)	4 in (102 mm)	3-7/32 in (82 mm)	\$63.00		\$80.00
2 lb	12874	2-1/8 in (54 mm)	3 in (76 mm)	1-3/4 in (45 mm)	\$60.00		\$65.00
1 lb	12876	1-11/16 in (43 mm)	2-1/2 in (64 mm)	1-13/32 in (38 mm)	\$55.00		\$65.00

Class 6

Nesting Slab

Weight	Part #	Length	Width	Height	Slot Width	Slot Depth*	Price	Optional Certificate	
								Accredited	
2,500 lb	12860	30 in (762 mm)	42 in (1067 mm)	8-1/4 in (210 mm)	2 in (51 mm)	2-1/4 in (57 mm)	\$8,900.00		\$235.00
1,000 lb	34563	19-1/2 in (495 mm)	29-1/2 in (749 mm)	7-1/4 in (184 mm)	2 in (51 mm)	2-1/4 in (57 mm)	\$4,500.00		\$235.00

* Slot depth refers to distance between lifting bars and castings.



PN 12860 Nesting Slab



PN 12839 Grip-handle

Accessories

Description	Part #	Price
Statement of Accuracy	36092	\$47.50
Serial number	25836	\$17.00

CAST IRON / GRIP-HANDLE

RANGE: 1,000 kg – 500 g

ASTM

Class 6

Weight	Part #	Length	Width	Height	Slot Width	Slot Depth*	Price	Optional Certificate	
								Accredited	
1,000 kg	12801	20-1/2 in (521mm)	20-1/2 in (521mm)	22 in (559 mm)	3-1/2 in (89 mm)	2-3/4 in (70 mm)	\$7,850.00		\$310.00
500 kg	12797	15-1/8 in (384mm)	15-1/8 in (384mm)	20-3/4 in (527 mm)	2-1/2 in (64 mm)	2 in (51 mm)	\$2,900.00		\$235.00
250 kg	12782	12-1/2 in (318mm)	11-1/2 in (292mm)	17-1/2 in (445 mm)	2-1/2 in (64 mm)	1-7/8 in (48 mm)	\$1,820.00		\$235.00
200 kg	12793	12 in (305mm)	11-1/2 in (292mm)	14-1/4 in (362 mm)	2-1/2 in (64 mm)	1-7/8 in (48 mm)	\$1,570.00		\$235.00
100 kg	12817	9-7/8 in (251mm)	9-7/8 in (251mm)	11 in (279 mm)	2-1/2 in (64 mm)	2 in (51 mm)	\$1,440.00		\$235.00
50 kg	12803	7 in (178mm)	9-7/32 in (234 mm)	8-13/16 in (224 mm)	4-15/32 in (114 mm)	1-29/32 in (48 mm)	\$625.00		\$130.00
35 kg	12805	5-1/2 in (140 mm)	7-7/8 in (200 mm)	9-15/32 in (252 mm)	4-15/32 in (114 mm)	1-1/16 in (27 mm)	\$450.00		\$130.00
25 kg	12775	5-1/2 in (140 mm)	7-21/32 in (195 mm)	7-3/32 in (180 mm)	4-7/16 in (113 mm)	1-13/16 in (46 mm)	\$175.00		\$75.00
20 kg	12771	5-19/32 in (142 mm)	7-5/8 in (194 mm)	5-29/32 in (150 mm)	4-5/8 in (118 mm)	1-19/32 in (41 mm)	\$145.00		\$75.00
10 kg	12767	4-1/2 in (114 mm)	6 in (152 mm)	5 in (127 mm)	3-3/4 in (95 mm)	1-1/16 in (27 mm)	\$140.00		\$75.00

Class 7

Weight	Part #	Length	Width	Height	Price	Optional Certificate	
						Accredited	
5 kg	12786	3-13/32 in (87 mm)	5-15/32 in (139 mm)	4-1/8 (105 mm)	\$83.00		\$75.00
2 kg	12809	2-9/16 in (65 mm)	3-31/32 in (101 mm)	2-13/16 in (71 mm)	\$70.00		\$75.00
1 kg	12813	2-1/8 in (54 mm)	3 in (76 mm)	1-27/32 in (47 mm)	\$60.00		\$55.00
500 g	12815	1-5/8 in (41 mm)	2-1/2 in (64 mm)	1-17/32 in (39 mm)	\$55.00		\$55.00

OIML

Class M1

Weight	Part #	Length	Width	Height	Slot Width	Slot Depth*	Price	Optional Certificate	
								Accredited	
500 kg	156304	15-1/8 in (384mm)	15-1/8 in (384mm)	20-3/4 in (527 mm)	2-1/2 in (64 mm)	2 in (51 mm)	\$3,050.00		\$235.00
250 kg	156305	12 in (305mm)	11-1/2 in (292mm)	17-1/2 in (445 mm)	2-1/2 in (64 mm)	1-7/8 in (48 mm)	\$1,910.00		\$235.00
100 kg	156306	9.87 in (251 mm)	9.87 in (251 mm)	11 in (279 mm)	2-1/2 in (64 mm)	2 in (51 mm)	\$1,510.00		\$235.00
50 kg	105417	7 in (178mm)	9-7/32 in (234 mm)	8-13/16 in (224 mm)	4-15/32 in (114 mm)	1-29/32 in (48 mm)	\$655.00		\$130.00
20 kg	105416	5-19/32 in (142 mm)	7-5/8 in (194 mm)	5-29/32 in (150 mm)	4-5/8 in (118 mm)	1-19/32 in (41 mm)	\$155.00		\$75.00
10 kg	105415	4-1/2 in (114 mm)	6 in (152 mm)	5 in (127 mm)	3-3/4 in (95 mm)	1-1/16 in (27 mm)	\$150.00		\$75.00
5 kg	105414	3-13/32 in (87 mm)	5-15/32 in (139 mm)	4-1/8 in (105 mm)	-	-	\$87.00		\$75.00

* Slot depth refers to distance between lifting bars and castings.

Accessories

Description	Part #	Price
Statement of Accuracy	36092	\$47.50
Serial number	25836	\$17.00



PN 12767 and PN 12771 OIML Grip-handle

ASTM
PRECISION

OIML
PRECISION

BALANCE
CALIBRATION

STAINLESS
FIELD WEIGHTS

CAST IRON
FIELD WEIGHTS

ASTM
SPECIALTY

ACCESSORIES

CAST IRON / SLOTTED INTERLOCKING AND HANGER

RANGE: 100 lb – 200 g

ASTM

Class 6

Slotted

Weight	Part #	Slot Width	Diameter	Height	Price
100 lb	40828	1 in (25 mm)	17 in (432 mm)	1-15/16 in (49 mm)	\$645.00
50 lb	12856	3/4 in (9 mm)	10-5/8 in (270 mm)	2-11/16 in (68 mm)	\$255.00
20 lb	12831	13/16 in (21 mm)	8-1/8 in (206 mm)	1-31/32 in (50 mm)	\$110.00

Optional Certificate

Accredited	Price
	\$105.00
	\$80.00
	\$80.00

Class 7

Slotted

Weight	Part #	Slot Width	Diameter	Height	Price
10 lb	12826	13/16 in (21 mm)	6-1/8 in (156 mm)	1-11/16 in (43 mm)	\$93.00
5 lb	12852	11/16 in (18 mm)	5-1/8 in (130 mm)	1-5/16 in (33 mm)	\$75.00
2 lb	12848	9/16 in (14 mm)	5 in (127 mm)	23/32 in (18 mm)	\$65.00
1 lb	12842	9/16 in (14 mm)	5 in (127 mm)	15/32 in (12 mm)	\$65.00
1/2 lb	12837	9/16 in (14 mm)	3-3/4 in (95 mm)	7/16 in (11 mm)	\$49.50

Optional Certificate

Accredited	Price
	\$80.00
	\$80.00
	\$65.00
	\$65.00
	\$40.00

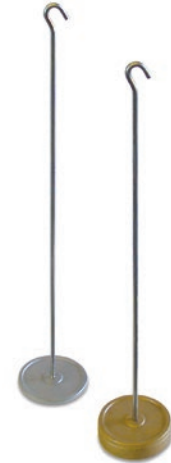

Class 7

Hanger

Weight	Part #	Capacity	Total Length	Operational Length	Diameter	Price
5 lb*	12846	500 lb	37-1/4 in (946 mm)	35 in (889 mm)	4 in (102 mm)	\$300.00
2 lb	12841	200 lb	21-13/32 in (544 mm)	19 in (483 mm)	3-3/4 in (95 mm)	\$150.00
2 lb	12835	200 lb	10-1/4 in (260 mm)	8 in (203 mm)	3-3/4 in (95 mm)	\$145.00
1 lb	12830	200 lb	21-29/32 in (556 mm)	20-7/32 in (514 mm)	3-3/4 in (95 mm)	\$130.00
1 lb	12825	200 lb	9-5/16 in (237 mm)	7-9/16 in (192 mm)	3-3/4 in (95 mm)	\$105.00

Optional Certificate

Accredited	Price
	\$80.00
	\$65.00
	\$65.00
	\$65.00
	\$65.00

* Stainless steel

Class 6

Slotted

Weight	Part #	Slot Width	Diameter	Height	Price
20 kg	12819	21/32 in (17 mm)	10-5/16 in (262 mm)	2-11/32 in (60 mm)	\$255.00
10 kg	12811	3/4 in (19 mm)	8-3/16 in (208 mm)	2-1/16 in (52 mm)	\$140.00

Optional Certificate

Accredited	Price
	\$75.00
	\$75.00

Class 7

Slotted

Weight	Part #	Slot Width	Diameter	Height	Price
5 kg	12807	13/16 in (21 mm)	6-3/16 in (157 mm)	1-13/16 in (46 mm)	\$130.00
2 kg	12799	9/16 in (14 mm)	5-1/8 in (130 mm)	1-3/16 in (30 mm)	\$75.00
1 kg	12795	9/16 in (14 mm)	5-1/16 in (129 mm)	3/4 in (19 mm)	\$66.00
500 g	12791	9/16 in (14 mm)	5 in (127 mm)	15/32 in (12 mm)	\$63.00
200 g	12780	5/8 in (16 mm)	3-21/32 in (93 mm)	7/16 in (11 mm)	\$51.00

Optional Certificate

Accredited	Price
	\$75.00
	\$75.00
	\$55.00
	\$55.00
	\$55.00

Class 7

Hanger

Weight	Part #	Capacity	Total Length	Operational Length	Diameter	Price
2 kg	12788	250 kg	37-1/4 in (946 mm)	35 in (889 mm)	4 in (102 mm)	\$300.00
1 kg	12784	100 kg	21-13/32 in (544 mm)	19 in (483 mm)	3-3/4 in (95 mm)	\$145.00
1 kg	12777	100 kg	10-1/4 in (260 mm)	8 in (203 mm)	3-3/4 in (95 mm)	\$145.00
500 g	12773	100 kg	21-29/32 in (556 mm)	20-7/32 in (514 mm)	3-3/4 in (95 mm)	\$130.00
500 g	12769	100 kg	9-5/16 in (237 mm)	7-9/16 in (192 mm)	3-3/4 in (95 mm)	\$115.00

Optional Certificate

Accredited	Price
	\$75.00
	\$55.00
	\$55.00
	\$55.00
	\$55.00

Accessories

Description	Part #	Price
Statement of Accuracy	36092	\$47.50
Serial number	25836	\$17.00



Avoirdupois

Metric

CAST IRON / COUNTERPOISE AND HANGER WEIGHTS

RANGE: 200 kg – 7 oz

ASTM

Class 7

Round

Weight	Part #	Ratio	Diameter	Fairbanks Part #	Price
50 lb x 1/2 lb	10154	1 lb - 100 lb	2-7/8 in (73 mm)	PA48	\$40.00
100 lb x 1 lb	10156	1 lb - 100 lb	4-1/16 in (103 mm)	PA32	\$45.50
200 lb x 2 lb	10158	1 lb - 100 lb	4-1/16 in (103 mm)	PA21	\$40.00
500 lb x 5 lb	10160	1 lb - 100 lb	3-3/4 in (95 mm)	Pb52	\$45.50
100 lb x 1/2 lb	10152	1/2 lb - 100 lb	2-7/8 in (73 mm)	PBC32	\$40.00
200 lb x 1 lb	10168	1/2 lb - 100 lb	3-17/32 in (90 mm)	PBC21	\$51.00
300 lb x 1 1/2 lb	10189	1/2 lb - 100 lb	3-1/2 in (89 mm)	-	\$40.00
500 lb x 2 1/2 lb	10170	1/2 lb - 100 lb	3-1/2 in (89 mm)	PBC52	\$58.00
1,000 lb x 5 lb	10196	1/2 lb - 100 lb	3-7/8 in (98 mm)	-	\$69.00

Class 7

Hexagon

Weight	Part #	Diameter	Price
10 kg x 100 g	10266	2 in (51 mm)	\$45.50
25 kg x 250 g	10268	2-13/16 in (71 mm)	\$45.50
50 kg x 500 g	10270	4 in (102 mm)	\$49.50
100 g x 1 kg	10272	4 in (102 mm)	\$55.00
200 kg x 2 kg	10274	4 in (102 mm)	\$60.00

Class 7

Square

Weight	Part #	Ratio	Diameter	Fairbanks Part #	Price
50 lb x 1/2 lb	10191	1 lb - 100 lb	2-5/16 in (59 mm)	1A2349	\$45.50
100 lb x 1 lb	10162	1 lb - 100 lb	3-1/2 in (89 mm)	1A1469	\$45.50
200 lb x 2 lb	10164	1 lb - 100 lb	3-1/2 in (89 mm)	1A1470	\$51.00
500 lb x 5 lb	10166	1 lb - 100 lb	3-1/2 in (89 mm)	1A1471	\$86.00

Round and Square

Hangers

Approx. Weight	Part #	Total Length	Operational Length	Diameter	Price
Round					
7 oz	10188	7-1/16 in (179 mm)	5-1/8 in (130 mm)	3-31/32 in (101 mm)	\$74.00
10 oz (Fairbanks® only)	10184	7-1/16 in (179 mm)	5-1/8 in (130 mm)	3-31/32 in (101 mm)	\$74.00
12 oz	10185	7-1/16 in (179 mm)	5-1/8 in (130 mm)	3-31/32 in (101 mm)	\$74.00
17 oz	10186	7-1/16 in (179 mm)	5-1/8 in (130 mm)	4 in (102 mm)	\$74.00
21 oz	10187	7-1/16 in (179 mm)	5-1/8 in (130 mm)	4 in (102 mm)	\$74.00
Square					
21 oz	10193	8-7/16 in (214 mm)	6-5/16 in (160 mm)	-	\$74.00



PN 10193 21 oz Square Hanger

PN 10185 12 oz Round Hanger

ASTM
PRECISION

OIML
PRECISION

BALANCE
CALIBRATION

STAINLESS
FIELD WEIGHTS

CAST IRON
FIELD WEIGHTS

ASTM
SPECIALTY

ACCESSORIES

CAST IRON / AVOIRDUPOIS COUNTERPOISE AND HANGER

RANGE: 500 lb – 7 oz

Class 7

Round

Weight	Part #	Diameter	Howe™ Part #	Price
50 lb x 1/2 lb	10367	3 in (76 mm)	42071831	\$51.00
100 lb x 1 lb	10369	2-7/8 in (73 mm)	42076188	\$51.00
200 lb x 2 lb	10371	2-31/32 in (75 mm)	42076189	\$51.00
300 lb x 3 lb	10373	2-31/32 in (75 mm)	42076190	\$51.00
500 lb x 5 lb	10385	3-1/8 in (79 mm)	42078947	\$51.00

Class 7 For Counting Scales

Round

Weight	Part #	Ratio	Diameter	Fairbanks Part #	Price
100 lb x 1 1/99 lb	10387	99 - 1	3 in (76 mm)	40810545	\$58.00
500 lb x 5 5/99 lb	10391	99 - 1	3-3/32 in (79 mm)	42111567	\$58.00
10 lb x 1 1/4 lb	10427	8 - 1	2-15/16 in (75 mm)	-	\$58.00
5 lb x 5/8 lb	10425	8 - 1	2-15/16 in (75 mm)	-	\$51.00
2 lb x 1/4 lb	10411	8 - 1	2-7/32 in (56 mm)	-	\$51.00
80 lb x 1 3/5 lb	10421	50 - 1	3 in (76 mm)	-	\$51.00
40 lb x 4/5 lb	10419	50 - 1	2-13/16 in (71 mm)	-	\$51.00
20 lb x 2/5 lb	10417	50 - 1	2-31/32 in (75 mm)	-	\$58.00
10 lb x 1/5 lb	10415	50 - 1	2 in (51 mm)	-	\$51.00
5 lb x 1/10 lb	10413	50 - 1	1-1/2 in (38 mm)	-	\$51.00
100 lb x 1 9/16 lb or 25 oz	10409	64 - 1	3 in (76 mm)	42111417	\$51.00
50 lb x 28/32 lb or 12 1/2 oz	10407	61 - 1	2-15/16 in (75 mm)	40807082	\$51.00
25 lb x 25/64 lb or 6 1/4 oz	10405	64 - 1	2-31/32 in (75 mm)	40807092	\$51.00
10 lb x 5/32 lb or 2 1/2 oz	10404	64 - 1	1-1/2 in (38 mm)	42111454	\$51.00

Round

Hangers

Approx. Weight	Part #	Total Length	Operational Length	Diameter	Price
7 oz	10382	8-1/4 in (210 mm)	6-3/16 in (157 mm)	2-31/32 in (75 mm)	\$69.00
10 oz	10379	8-1/4 in (210 mm)	6-3/16 in (157 mm)	2-31/32 in (75 mm)	\$69.00
12 oz	10380	8-1/4 in (210 mm)	6-3/16 in (157 mm)	2-31/32 in (75 mm)	\$115.00
16 oz	10381	8-1/4 in (210 mm)	6-3/16 in (157 mm)	2-31/32 in (75 mm)	\$115.00

Triangle

Approx. Weight	Part #	Toledo® Part #	Price
100 lb x 1 lb	11417	49868	\$40.00
200 lb x 2 lb	11419	49869	\$45.50
500 lb x 5 lb	11421	49870	\$69.00

Triangle

Hangers

Approx. Weight	Part #	Total Length	Operational Length	Toledo® Part #	Price
14 oz	11423	8-1/4 in (210 mm)	6-3/16 in (157 mm)	49857	\$69.00

Triangle Single
and Hanger

ASTM Specialty Calibration Weights

Applications:

Tolerance test or checking

Equipment verification in
unique units of measurement

Slotted weights for suspended
verification of weight

Forklift weights for forklift scale calibration

Designs Available:

Cube

Ring

Lift truck weights

Hook weights

Stainless steel slotted weights

Unique Units of Measure:

Penny weight

Grain

Troy ounce

Features:

Nominal value marked on weights

Cavity for adjustment

Cube weight sets designed as sealer's kits
for calibration adjustments





*Metric Cube and Ring Weights;
Avoirdupois Ring Weights*

118 RANGE: 5 lb – 25 g

Troy Ounce Cylindrical/Leaf Weights

119 Range: 500 oz t – 0.005 oz t

*Pennyweight Cylindrical and Leaf,
and Grain Weights*

120 Range: 20 dwt – 20 gr

Specialty Weights/Cube Weights Sets

121 Range: 1kg – 1mg

*Avoirdupois and Metric
Single Hook Weights*

122 Range: 25 kg – 1/32 oz

*Avoirdupois/Metric Single
Hangers/Slotted Weights*

123 Range: 5 lb – 100 g

Lift Truck Weights and Clean Room Cart

124 Range: 50 kg - 2,000 lb

SPECIALTY CALIBRATION WEIGHTS / METRIC CUBE AND RING WEIGHTS; AVOIRDUPOIS RING WEIGHTS

RANGE: 5 lb – 25 g

Class 5

Cube

Weight	Part #	Length	Width	Height	Price	Accredited
2 lb	12649	1 in (25 mm)	2.4 in (61 mm)	3 in (76 mm)	\$165.00	\$65.00
1 lb	12651	1 in (25 mm)	1.2 in (31 mm)	3 in (76 mm)	\$150.00	\$65.00
8 oz	12653	1 in (25 mm)	1-9/10 in (48 mm)	1 in (25 mm)	\$130.00	\$55.00
2 oz	12658	0.60 in (15 mm)	0.70 in (18 mm)	1 in (25 mm)	\$93.00	\$55.00
4 oz	12655	1 in (25 mm)	73/100 in (19 mm)	309/1000 in (33 mm)	\$110.00	\$55.00
1 kg	12557	3-3/8 in (87 mm)	1 in (25 mm)	2-1/2 in (63 mm)	\$165.00	\$55.00
500 g	12552	3-13/32 in (87 mm)	1 in (25 mm)	1-1/4 in (32 mm)	\$130.00	\$55.00
300 g	12547	1-1/4 in (32 mm)	2-1/32 in (52 mm)	1 in (25 mm)	\$120.00	\$55.00
200 g	12544	1-3/8 in (35 mm)	1-1/4 in (31 mm)	1 in (25 mm)	\$110.00	\$55.00
100 g	12541	1-7/32 in (31 mm)	3/4 in (19 mm)	1 in (25 mm)	\$93.00	\$40.00

Optional Certificate

Class 5

Ring

Weight	Part #	Outside Dia.	Inside Dia.	Height	Price	Accredited
500 g	12566	3 in (76 mm)	25/64 in (10 mm)	37/64 in (15 mm)	\$140.00	\$55.00
200 g	12563	2 in (51 mm)	25/64 in (10 mm)	17/32 in (14 mm)	\$115.00	\$55.00
100 g	12561	1-1/2 in (38 mm)	25/64 in (10 mm)	1/2 in (13 mm)	\$93.00	\$40.00
50 g	12560	1-1/2 in (38 mm)	25/64 in (10 mm)	1/4 in (6 mm)	\$79.00	\$40.00
25 g	12559	1 in (25 mm)	25/64 in (10 mm)	5/16 in (8 mm)	\$62.00	\$40.00
5 lb	12672	4 in (102 mm)	25/64 in (10 mm)	1-7/16 in (37 mm)	\$125.00	\$80.00
3 lb	12671	3 in (76 mm)	25/64 in (10 mm)	1-35/64 in (36 mm)	\$100.00	\$80.00
2 lb	12670	3 in (76 mm)	25/64 in (10 mm)	1-1/32 in (26 mm)	\$79.00	\$65.00
1 lb	12669	3 in (76 mm)	25/64 in (10 mm)	33/64 in (13 mm)	\$79.00	\$65.00
8 oz	12668	2 in (51 mm)	25/64 in (10 mm)	39/64 in (16 mm)	\$38.50	\$40.00
4 oz	12667	1-1/2 in (38 mm)	25/64 in (10 mm)	9/16 in (14 mm)	\$38.50	\$40.00
2 oz	12666	1 1/2 in (38 mm)	25/64 in (10 mm)	9/32 in (7 mm)	\$38.50	\$40.00
1 oz	12665	1 in (25 mm)	25/64 in (10 mm)	11/32 in (9 mm)	\$38.50	\$40.00
1/2 oz	12664	1 in (25 mm)	25/64 in (10 mm)	11/64 in (4 mm)	\$73.00	\$40.00
1/4 oz	12663	1 in (25 mm)	25/64 in (10 mm)	3/32 in (2 mm)	\$100.00	\$40.00

Optional Certificate

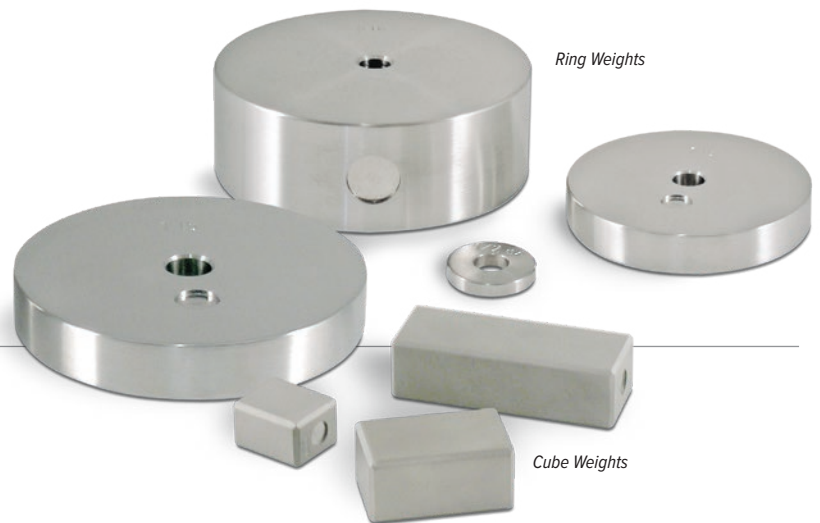

Ring Weights

Cube Weights

Accessories

Description	Part #	Price
Statement of Accuracy	36092	\$47.50
Serial number	25836	\$17.00

SPECIALTY CALIBRATION WEIGHTS / TROY OUNCE

RANGE: 500 oz t – 0.005 oz t

Class 5 Cylindrical

Weight	Part #	Height	Diameter	Price
500 oz t	12719	6-5/16 in (160 mm)	5 in (127 mm)	\$1,200.00
200 oz t	12718	3-3/4 in (95 mm)	4-25/32 in (121 mm)	\$525.00
100 oz t	12717	3-13/16 in (96 mm)	3 in (75 mm)	\$315.00
50 oz t	12716	2-5/8 in (67 mm)	2-21/32 in (68 mm)	\$185.00
20 oz t	12715	2-1/4 in (57 mm)	1-3/4 in (44 mm)	\$93.00
10 oz t	12714	1-3/8 in (35 mm)	1-29/32 in (48 mm)	\$74.00
5 oz t	12713	1-3/16 in (30 mm)	1-13/32 in (36 mm)	\$74.00
2 oz t	12712	7/8 in (22 mm)	31/32 in (25 mm)	\$43.00
1 oz t	12711	7/8 in (21 mm)	5/8 in (16 mm)	\$40.00
1/4 oz t	12709	11/16 in (17 mm)	3/8 in (9 mm)	\$48.50
1/8 oz t	12708	5/16 in (8 mm)	15/32 in (12 mm)	\$48.50
1/16 oz t	12707	3/8 in (9 mm)	1/4 in (6 mm)	\$48.50
1/32 oz t	12706	5/16 in (8 mm)	3/16 in (5 mm)	\$48.50
0.5 oz t	12705	1/2 in (13 mm)	23/32 in (18 mm)	\$48.50
0.2 oz t	12704	1/2 in (13 mm)	3/8 in (9 mm)	\$48.50
0.1 oz t	12703	5/16 in (8 mm)	13/32 in (10 mm)	\$48.50
0.05 oz t	12702	1/4 in (6 mm)	11/32 in (9 mm)	\$48.50

Optional Certificate

Accredited
\$80.00
\$80.00
\$80.00
\$80.00
\$65.00
\$40.00
\$40.00
\$40.00
\$40.00
\$40.00
\$40.00
\$40.00
\$40.00
\$40.00
\$40.00
\$40.00

Class 5 Leaf

Weight	Part #	Height	Diameter	Price
0.02 oz t	12701	W x L (0.375 in x 0.287 in)	-	\$37.50
0.01 oz t	12700	W x L (0.312 in x 0.270 in)	-	\$37.50
0.005 oz t	12699	W x L (0.25 in x 0.22 in)	-	\$37.50

Optional Certificate

Accredited
\$40.00
\$40.00
\$40.00



PN 12714 Cylindrical Weight

Accessories

Description	Part #	Price
Statement of Accuracy	36092	\$47.50
Serial number	25836	\$17.00

ASTM
PRECISION

OIML
PRECISION

BALANCE
CALIBRATION

STAINLESS
FIELD WEIGHTS

CAST IRON
FIELD WEIGHTS

ASTM
SPECIALTY

ACCESSORIES

SPECIALTY CALIBRATION WEIGHTS / PENNYWEIGHT CYLINDRICAL AND LEAF, AND GRAIN WEIGHTS

RANGE: 20 dwt – 20 gr

Class 5

Cylindrical

Optional Certificate

Weight	Part #	Price	Accredited
20 dwt	12698	\$79.00	\$40.00
10 dwt	12697	\$79.00	\$40.00
5 dwt	12696	\$79.00	\$40.00
2 dwt	12695	\$79.00	\$40.00
1 dwt	12694	\$79.00	\$40.00

Class 5

Leaf

Optional Certificate

Weight	Part #	Price	Accredited
0.5 dwt	12693	\$70.00	\$55.00
0.2 dwt	12692	\$70.00	\$55.00
0.1 dwt	12691	\$70.00	\$40.00

Class 5

Grain

Optional Certificate

Weight	Part #	Price	Accredited
1 gr	12726	\$26.50	\$55.00
2 gr	12727	\$30.00	\$55.00
10 gr	12733	\$30.00	\$40.00
20 gr	12736	\$37.50	\$40.00



PN 12693 Pennyweight Leaf Weight



PN 12695 Cylindrical

Accessories

Description	Part #	Price
Statement of Accuracy	36092	\$47.50
Serial number	25836	\$17.00

SPECIALTY CALIBRATION WEIGHTS / CUBE WEIGHTS SETS

RANGE: 1kg – 1mg

Class 5

Cube Avoirdupois

Optional Certificate

Set Size	Part #	Price	Accredited
8 oz - 1/16 oz	12630	\$340.00	\$230.00
(3) 2 lb - 1/16 oz	12652	\$1,000.00	\$379.00
(3) 2 lb - .001lb	12659	\$1,130.00	\$457.00
(14) 2 lb - 1/16 oz	12585	\$1,640.00	\$918.00

Class 5

Cube Metric

Optional Certificate

Set Size	Part #	Price	Accredited
300 g - 10 g	12545	\$345.00	\$280.00
(14) 1kg - 1mg	12553*	\$2,280.00	\$999.00
(3) 1kg - 1mg	12555*	\$1,420.00	\$645.00

Weight Set Contents

8 oz - 1/16 oz	2 lb - 1/16 oz	2 lb - 0.001lb	2 lb - 1/16 oz
12630	12652	12659	12585
1 - 8 oz*	3 - 2lb*	3 - 2lb*	14 - 2lb*
1 - 4 oz*	1 - 1lb*	1 - 1lb*	2 - 1lb*
1 - 2 oz*	1 - 8 oz*	1 - 0.3 lb	1 - 8 oz*
1 - 1oz	1 - 4 oz*	1 - 0.2 lb	1 - 4 oz*
1 - 1/2 oz	1 - 2 oz*	1 - 0.1lb	1 - 2 oz*
1 - 1/4 oz	1 - 1oz	1 - 0.05 lb	1 - 1oz
1 - 1/8 oz	1 - 1/2 oz	1 - 0.03 lb	1 - 1/2 oz
2 - 1/16 oz	1 - 1/4 oz	1 - 0.02 lb	1 - 1/4 oz
	1 - 1/8 oz	1 - 0.01lb	1 - 1/8 oz
	2 - 1/16 oz	1 - 0.005lb	2 - 1/16 oz
		1 - 0.003 lb	
		1 - 0.002 lb	
		2 - 001lb	
9 pcs. 1lb set wt.	13 pcs. 8lb set wt.	16 pcs. 7.72lb set wt.	25 pcs. 31lb set wt.

300 g - 10 g	1kg - 1mg	1kg - 1mg
12545	12553	12555
-	14 - 1kg*	3 - 1kg*
-	2 - 500 g*	1 - 500 g*
1 - 300 g*	1 - 300 g*	1 - 300 g*
1 - 200 g*	1 - 200 g*	1 - 200 g*
1 - 100 g*	1 - 100 g*	1 - 100 g*
1 - 50 g	1 - 50 g	1 - 50 g
1 - 30 g	1 - 30 g	1 - 30 g
1 - 20 g	1 - 20 g	1 - 20 g
1 - 10 g	1 - 10 g	1 - 10 g
1 - 5 g	1 - 5 g	1 - 5 g
1 - 3 g	1 - 3 g	1 - 3 g
1 - 2 g	1 - 2 g	1 - 2 g
1 - 1g	1 - 1g	1 - 1 g
1 - 500 mg	1 - 500 mg	1 - 500 mg
1 - 300 mg	1 - 300 mg	1 - 300 mg
1 - 200 mg	1 - 200 mg	1 - 200 mg
1 - 100 mg	1 - 100 mg	1 - 100 mg
1 - 50 mg	1 - 50 mg	1 - 50 mg
1 - 30 mg	1 - 30 mg	1 - 30 mg
1 - 20 mg	1 - 20 mg	1 - 20 mg
1 - 10 mg	1 - 10 mg	1 - 10 mg
	1 - 5 mg	1 - 5 mg
	1 - 3 mg	1 - 3 mg
	1 - 2 mg	1 - 2 mg
	1 - 1mg	1 - 1 mg
7 pcs. 710g set wt.	39 pcs 15,722.221g set wt.	27 pcs. 4,222.221g set wt.

*Cube Weight

Replacement Cases

Cube Avoirdupois Main Cases		
Class 5		
Set Size	Part #	Price
8 oz - 1/16 oz	11510	\$37.50
(3) 2 lb - 1/16 oz	11569	\$225.00
(3) 2 lb - .001lb	11569	\$225.00
(14) 2 lb - 1/16 oz	40783	\$360.00

Cube Metric Main Cases		
Class 5		
Size	Part #	Price
300 g - 10 g	11510	\$37.50
(14) 1kg - 1mg	40783	\$360.00
(3) 1kg - 1mg	11569	\$225.00

Inserts		
Class 5		
Size	Part #	Price
300 g - 10 g	11526	\$40.00
5 g - 1mg	11527	\$37.50
(2) 50 g - 1mg	11528	\$40.00
1kg - 1mg	11526	\$40.00
(3) 1kg - 1mg	11526	\$40.00

Accessories

Description	Part #	Price
Statement of Accuracy	36092	\$47.50
Leaf weight cover	11758	\$43.00
Tweezer	65640	\$21.00
Serial number	25836	\$17.00
Premium tweezer	152414	\$43.00

SPECIALTY CALIBRATION WEIGHTS / AVOIRDUPOIS AND METRIC SINGLE HOOK WEIGHTS

RANGE: 25 kg – 1/32 oz

Class 6

Hook Metric

Weight	Part #	Diameter	Hanging Height	Opening Diameter	Price
25 kg	12720	5-31/32 in (152 mm)	9-3/16 in (233 mm)	1/4 in (6 mm)	\$945.00
20 kg	12725	5-31/32 in (152 mm)	8-3/8 in (213 mm)	1/4 in (6 mm)	\$925.00
10 kg	12732	4 in (102 mm)	9-1/16 in (230 mm)	1/4 in (6 mm)	\$635.00
5 kg	12735	3-3/4 in (95 mm)	6-11/32 in (161 mm)	1/4 in (6 mm)	\$315.00
4 kg	161608	3-1/2 in (89 mm)	6.12 in (155 mm)	1/4 in (6 mm)	\$310.00
3 kg	96403	2-5/8 in (67 mm)	5-1/16 in (129 mm)	1/4 in (6 mm)	\$295.00
2 kg	12739	2-5/8 in (67 mm)	5-17/32 in (136 mm)	1/4 in (6 mm)	\$225.00
1 kg	12744	2 in (51 mm)	5-3/8 in (137 mm)	1/4 in (6 mm)	\$125.00
500 g	12747	1-5/8 in (41 mm)	4-1/2 in (114 mm)	5/32 in (4 mm)	\$105.00
300 g	96404	1-1/4 in (32 mm)	4-1/2 in (114 mm)	5/32 in (4 mm)	\$105.00
200 g	12748	1-1/8 in (29 mm)	3 in (76 mm)	3/32 in (2 mm)	\$105.00
100 g	12749	1 in (25 mm)	2-3/8 in (60 mm)	3/32 in (2 mm)	\$93.00
50 g	12750	3/4 in (19 mm)	2-1/4 in (57 mm)	3/32 in (2 mm)	\$93.00
30 g	96405	5/8 in (16 mm)	2-1/8 in (54 mm)	3/32 in (2 mm)	\$93.00
20 g	12751	5/8 in (16 mm)	2-1/8 in (54 mm)	3/32 in (2 mm)	\$93.00
10 g	12754	1/2 in (13 mm)	2 in (50.8 mm)	3/32 in (2 mm)	\$68.00

Optional Certificate

Accredited
\$75.00
\$75.00
\$75.00
\$75.00
\$75.00
\$75.00
\$75.00
\$55.00
\$55.00
\$55.00
\$40.00
\$40.00
\$40.00
\$40.00
\$40.00

Hook Only

Weight	Part #	Diameter	Hanging Height	Opening Diameter	Price
5 g	12757	1/8 in (3 mm)	2-5/32 in (55 mm)	3/16 in (5 mm)	\$62.00
3 g	96406	3/32 in (2 mm)	2.32 in (59 mm)	3/16 in (5 mm)	\$54.00
2 g	12762	3/32 in (2 mm)	1-7/32 in (31 mm)	3/16 in (5 mm)	\$54.00
1 g	12766	1/16 in (2 mm)	1-21/32 in (42 mm)	3/16 in (5 mm)	\$54.00

Optional Certificate

Accredited
\$40.00
\$40.00
\$40.00
\$40.00

Class 6

Hook Avoirdupois

Weight	Part #	Diameter	Hanging Height	Opening Diameter	Price
50 lb	12894	5-31/32 in (152 mm)	9-1/4 in (235 mm)	1/4 in (6 mm)	\$945.00
25 lb	96408	4-19/32 in (117 mm)	5-3/4 in (146 mm)	1/4 in (6 mm)	\$855.00
20 lb	12895	4 in (102 mm)	9-3/16 in (233 mm)	1/4 in (6 mm)	\$615.00
10 lb	12896	3-1/2 in (89 mm)	6-1/4 in (159 mm)	1/4 in (6 mm)	\$310.00
5 lb	12897	2-5/8 in (67 mm)	6-1/2 in (165 mm)	1/4 in (6 mm)	\$215.00
3 lb	96409	2-1/4 in (57 mm)	4-1/32 in (102 mm)	1/4 in (6 mm)	\$200.00
2 lb	12898	2 in (51 mm)	5 in (127 mm)	1/4 in (6 mm)	\$125.00
1 lb	12899	1-5/8 in (41 mm)	4-1/2 in (114 mm)	5/32 in (4 mm)	\$93.00
0.2 lb	96410	1 in (25 mm)	2-5/16 in (59 mm)	3/32 in (2 mm)	\$79.00
0.1 lb	96411	3/4 in (19 mm)	2-5/32 in (55 mm)	3/32 in (2 mm)	\$79.00
8 oz	12900	1-1/4 in (32 mm)	4 in (102 mm)	5/32 in (4 mm)	\$79.00
4 oz	12901	1 in (25 mm)	2-1/4 in (57 mm)	3/32 in (2 mm)	\$79.00
2 oz	12902	13/16 in (21 mm)	2-1/4 in (57 mm)	3/32 in (2 mm)	\$79.00
1 oz	12903	5/8 in (16 mm)	2-1/4 in (57 mm)	3/32 in (2 mm)	\$79.00
1/2 oz	12904	17/32 in (14 mm)	2-29/32 in (74 mm)	3/32 in (2 mm)	\$73.00

Optional Certificate

Accredited
\$80.00
\$80.00
\$80.00
\$80.00
\$80.00
\$80.00
\$65.00
\$65.00
\$40.00
\$40.00
\$40.00
\$40.00
\$40.00
\$40.00
\$40.00

Hook Only

Weight	Part #	Diameter	Hanging Height	Opening Diameter	Price
1/4 oz	12905	5/32 in (4 mm)	1-13/16 in (46 mm)	3/16 in (5 mm)	\$54.00
1/8 oz	12906	1/8 in (3 mm)	1-1/8 in (27 mm)	3/16 in (5 mm)	\$54.00
1/16 oz	12907	3/32 in (2 mm)	1-1/4 in (32 mm)	3/16 in (5 mm)	\$54.00
1/32 oz	12908	1/16 in (2 mm)	1-13/32 in (36 mm)	3/16 in (5 mm)	\$54.00

Optional Certificate

Accredited
\$40.00
\$40.00
\$40.00
\$40.00

Hook (only) Weight (5g - 1g)
and (1/4-1/32 oz)

Accessories

Description	Part #	Price
Statement of Accuracy	36092	\$47.50
Serial number	25836	\$17.00



Hook Weights

SPECIALTY CALIBRATION WEIGHTS / AVOIRDUPOIS/METRIC SINGLE HANGERS/SLOTTED WEIGHTS

RANGE: 5 lb – 100 g

Class 7

Stainless Steel Hanger

Weight	Part #	Length	Diameter	Total Cap	Price
5 lb	12846	37 1/4 in	4 in (102 mm)	500 lb	\$300.00
3 kg	156937	38 3/16 in	4 in (102 mm)	250 kg	\$310.00

Optional Certificate

Accredited
\$80.00
\$75.00

Class 5

Slotted Avoirdupois

Weight	Part #	Diameter	Height	Slot Width	Price
10 lb	12589	4 in (102 mm)	3-1/8 in (79 mm)	1/2 in (13 mm)	\$600.00
5 lb	12586	4 in (102 mm)	1-9/16 in (40 mm)	1/2 in (13 mm)	\$375.00
2 lb	12577	3 in (76 mm)	1-9/64 in (29 mm)	1/2 in (13 mm)	\$235.00
1 lb	12574	3 in (76 mm)	19/32 in (15 mm)	1/2 in (13 mm)	\$200.00
8 oz	12583	2 in (51 mm)	45/64 in (18 mm)	1/2 in (13 mm)	\$175.00
4 oz	12580	1-1/2 in (38 mm)	11/16 in (18 mm)	1/2 in (13 mm)	\$135.00

Optional Certificate

Accredited
\$80.00
\$80.00
\$65.00
\$65.00
\$40.00
\$40.00

Class 5

Slotted Metric

Weight	Part #	Diameter	Height	Slot Width	Price
5 kg	156931	4 in (102 mm)	3-1/8 in (79 mm)	1/2 in (13 mm)	\$555.00
2 kg	156932	4 in (102 mm)	1-9/16 in (40 mm)	1/2 in (13 mm)	\$385.00
1 kg	156933	3 in (76 mm)	1.27 in (32 mm)	1/2 in (13 mm)	\$225.00
500 g	156934	3 in (76 mm)	0.836 in (21 mm)	1/2 in (13 mm)	\$205.00
200 g	156935	1-1/2 in (38 mm)	0.801 in (20 mm)	1/2 in (13 mm)	\$170.00
100 g	156936	1-1/2 in (38 mm)	0.601 in (15 mm)	1/2 in (13 mm)	\$110.00

Optional Certificate

Accredited
\$75.00
\$75.00
\$55.00
\$55.00
\$55.00
\$40.00



Slotted

Accessories

Description	Part #	Price
Statement of Accuracy	36092	\$47.50
Serial number	25836	\$17.00

ASTM
PRECISION

OIML
PRECISION

BALANCE
CALIBRATION

STAINLESS
FIELD WEIGHTS

CAST IRON
FIELD WEIGHTS

ASTM
SPECIALTY

ACCESSORIES

SPECIALTY CALIBRATION WEIGHTS / LIFT TRUCK WEIGHTS AND CLEAN ROOM CART

RANGE: 50 kg – 2,000 lb

Painted Steel Lift Truck Weights

Class 6

Optional Certificate

Weight	Part #	Price	Accredited
1,000 lb	120160	\$2,650.00	\$235.00
2,000 lb	120162	\$7,875.00	\$235.00

Dimensions

PN 120160		PN 120162	
A	38.25 in	A	34.25 in
B	6.0 in	B	6.0 in
C	22.5 in	C	22.5 in
D	46.25 in	D	46.25 in

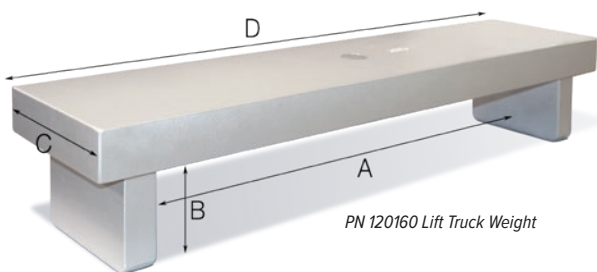

Stainless Steel Clean Room Weight Cart

Class 6

Optional Certificate

Weight	Part #	Description	Price	Accredited
50 kg	178045	16 x 16 in	\$5,025.00	\$235.00
100 kg	180033	16 x 16 in	\$5,650.00	\$235.00
200 kg	180624	16 x 16 in	\$7,025.00	\$235.00
250 kg	180625	18 x 18 in	\$8,900.00	\$235.00
500 kg	180034	18 x 18 in	\$15,850.00	\$235.00

Clean Room, Weigh Cart
(Calibration Optional)

ASTM PRECISION

OIML PRECISION

BALANCE CALIBRATION

STAINLESS FIELD WEIGHTS

CAST IRON FIELD WEIGHTS

ASTM SPECIALTY

ACCESSORIES

Accessories & Cases

Guidelines for Selecting a Case:

Find the diameter, height,
and total mass of the weights
that will need a case

Review case dimensions
to determine best fit

Note weight limits of the case
and choose accordingly

Things to keep in mind:

Foam needs 0.5 inches between weights and
edge of case

Always select the smallest case best fitting your need

Weights should always be stored and transported
in the upright position

The shoulder edge of the weight should be level
with the foam insert

Some cases are recommended for storage only and
should not be used for shipping



Accessories & cases

- 124** Cases
- 126** Sealing Plugs
Canvas Dust Covers
Gloves
- 127** Transfer Equipment
Transfer Cart
Touch-Up Paint

CASES

Industrial-Quality Cases

These heavy-duty cases are designed to be used in place of large wooden cases when portability is desired. The recessed latches provide protection assurance for your weights.

Pelican Cases

- Pick N Pluck™ with convoluted lid foam
- Watertight, crushproof and dustproof
- Durable, lightweight container design
- Rubber over-molded handle
- Secure, integrated latches
- Stainless steel padlock protectors
- Custom inserts available upon request

Black Thermoformed Cases

- Excellent for transporting weights
- Recessed, heavy-duty latches confidently secure contents
- Ergonomic handles retain preferred treatment of weights
- Metal hardware resists natural wear and tear
- Special case cuttings are required for heavy duty cases at an additional charge

Black Injection-Molded Watertight Case

- Designed for custom weight sets
- Ergonomic top-mounted handle provides ideal weight positioning
- Interior is custom-molded to the weights to be stored

Medium-Duty Cases

Medium-duty cases are primarily used for manually transporting test weights as they effectively absorb shock and resist changes in environment.

ABS Plastic

- ABS plastic is considered superior for its strength, gloss, and electrical insulation properties—an excellent choice for encasing weights
- All metal hardware establishes the security of your weights
- Top-mounted handle makes transporting the weights effortless
- Custom-cut foam inserts are used for insulating between the weights
- Three sizes available

Wooden Cases

(Other cases and sizes available by custom order)

- Walnut-constructed and felt-lined
- Built-to-order and designed specifically for your weight sets
- Not available as an accessory purchase
- Available in 5 kg-20 kg capacities
- Secured by hinged latches
- Case keeps weights free of dust and contaminants
- Protects your weights in storage and during transportation
- Cases should be packed in an external box during shipping to protect them

PVC Cases

(Other cases and sizes available by custom order)

- Available in capacities from 100 g-1 mg for Precision Mass Reference Standards
- Also available for ASTM Class 0 weights in 100 g-1 mg capacities



Pelican Cases

Length	Width	Closed Height	Max Load	Part #	Price
17 in	22 in	8 in	75 lb	21230	\$420.00
11.75 in	17 in	6 in	50 lb	21229	\$285.00

Black Thermoformed Cases

Length	Width	Closed Height	Max Load	Part #	Price
22.4 in	16.3 in	10.5 in	95 lb	156989	\$845.00
16.4 in	11.4 in	9 in	55 lb	156285	\$570.00
9.9 in	9.9 in	11 in	60 lb	156284	\$455.00

Black Injection-Molded Watertight Case

Length	Width	Closed Height	Max Load	Part #	Price
12.63 in	9.5 in	4.75 in	20 lb	158121	\$325.00



ABS Plastic

Length	Width	Closed Height	Max Load	Part #	Price
7.625 in	13.5 in	6 in	40 lb	11531	\$250.00
9.375 in	14.375 in	7.625 in	55 lb	11534	\$260.00
6.5 in	8.375 in	7.125 in	25 lb	11572	\$190.00



ABS Plastic Case (Weights shown are not included with case)

CASES

Light-Duty/Single Weight Cases

Light-duty/single weight cases can be used for storage and shipping smaller capacity weights within additional materials.

Plastic

- Light-duty plastic cases are used for shipping lighter capacity weights—typically single weights not exceeding 5 lb
- Plastic hinges, latches, and side-mounted handle keep this case extremely lightweight and portable
- Uncut foam is included while custom-cut is available for an extra charge
- Custom-cut foam insert protects each weight from impact during transport

Leatherette

- Secure storage of single weights with snap lid
- Considered light-duty and used for storage and shipping
- Leatherette is a non-porous material—ideal for weight protection
- Two sizes of leatherette cases available

Clean Room

Acrylic

- Ideal for all clean room environments
- Tough, clear acrylic protects your valuable investment
- Provide compliance for stringent clean room requirements
- Not recommended for shipping, developed exclusively for storage
- Available as an accessory only
- Optional custom inserts available up request

Polycarbonate Cases

- Light-duty cases for single weights
- Suitable for clean room storage and shipping lighter capacity weights
- Three case sizes with different insert sizes
- Transparent lid for easy weight identification
- Secure-latch lid for weight protection



PN 34645



PN 11596

Wooden and PVC

Description	Part #	Price
PVC case for precision laboratory mass reference standards, 100 g-1 mg range (5-2-2-1 configuration)	11596	\$180.00
Wooden case built-to-order for field standards and balance calibration weights, 500 g-1 mg range	34645	\$330.00



PN 87982

PN 69229

Polycarbonate Case

Plastic

Length	Width	Closed Height	Max Load	Part #	Price
8 in	12 in	3.5 in	5 lb	87982	\$81.00

Leatherette

Length	Width	Closed Height	Max Load	Part #	Price
1.875 in	3.75 in	1.0625 in	3 lb	69429	\$37.50
2.5 in	3.4375 in	.875 in	1 lb	69229	\$37.50



PN 89180 and PN 89179
Shown with optional insert

Acrylic Clean Room

Length	Width	Closed Height	Part #	Price
3.04 in	6.04 in	1.8 in	89179	\$125.00
4.7 in	8.7 in	2.8 in	89180	\$230.00
5.25 in	12 in	4 in	89181	\$365.00
8.5 in	13.25 in	5.75 in	89182	\$575.00
PVC Insert			Consult	Consult

Polycarbonate

Length	Width	Closed Height	Part #	Price
4.25 in	4.25 in	4.875 in	Consult	\$32.00
3.12 in	3.12 in	3.61 in	Consult	\$32.00
2.25 in	2.25 in	2.45 in	Consult	\$35.00

Sealers Cube Wt - with precut foam insert

Length	Width	Closed Height	Part #	Price
9.375 in	14.375 in	7.625 in	40783	\$360.00

Protection Containers

Description	Part #	Price
Capsule	80420	\$5.00
Vial	50038	\$5.00

ASTM
PRECISION

OIML
PRECISION

BALANCE
CALIBRATION

STAINLESS
FIELD WEIGHTS

CAST IRON
FIELD WEIGHTS

ASTM
SPECIALTY

ACCESSORIES

SEALING PLUGS

Lead

Diameter	Part #	Price
2.75 in (69.8 mm)	11749	\$5.50
1.875 in (47.6 mm)	11750	\$5.00
1 in (25.4 mm)	11751	\$4.50
0.5 in (12.7 mm)	11752	\$4.50
1.25 in (31.7 mm)	11753	\$4.50
0.5626 in (14.3 mm)	11760	\$4.50
0.625 in (15.9 mm)	11761	\$4.50
0.75 in (19.1 mm)	11765	\$4.50
0.875 in (22.2 mm)	11785	\$4.50

Aluminum

Diameter	Part #	Price
0.375 in (9.5 mm)	11744	\$2.50
0.5 in (12.7 mm)	11745	\$2.50
0.625 in (15.9 mm)	11746	\$2.50
1 in (25.4 mm)	11762	\$2.50
0.5626 in (14.3 mm)	11767	\$4.50
0.875 in (22.2 mm)	11775	\$4.00
0.75 in (19.1 mm)	11776	\$2.50

Backup

Diameter	Part #	Price
2.75 in (69.8 mm)	11748	\$6.25
.75 in (19.1 mm)	11766	\$4.50
1 in (25.4 mm)	11710	\$2.50
1.875 in (47.6 mm)	11699	\$2.50

Backup Stainless Steel

Diameter	Part #	Price
1 in (25.4 mm)	44992	\$2.50
.625 in (15.9 mm)	44993	\$5.00
.325 in (9.5 mm)	44994	\$5.50

Stainless Steel

Diameter	Part #	Price
.9375 in (23.0 mm)	11709	\$4.50



CANVAS DUST COVERS

Canvas Dust Covers

Weight	Part #	Capacity	Cover Part #	Price
12890	200 lb	11720	\$220.00	
12844	500 lb	11722	\$220.00	
12880	750 lb	11723	\$220.00	
12850	1,000 lb	11724	\$220.00	
12858	1,250 lb	11727	\$220.00	
12866	2,000 lb	11729	\$220.00	

Weight	Part #	Capacity	Cover Part #	Price
12817	100 kg	11738	\$220.00	
12782	250 kg	11740	\$220.00	
12797	500 kg	11741	\$220.00	
12801	1,000 kg	11742	\$220.00	
12821	2,000 kg	11743	\$220.00	



GLOVES

Cotton 11714

- Essential tool for proper weight-handling
- Proper protection for preventing hand residue
- Residue can impact a weight's calibration and certification for accuracy
- Rice Lake recommends using cotton gloves to handle all precision weights



Vinyl 11773

- Vinyl gloves are an acceptable handling tool to keep dirt and residue off your weights
- Better than handling precision weights bare-handed
- Vinyl gloves are economical, disposable, convenient, and help maintain the integrity of your weights



Gloves

Description	Part #	Price
Cotton glove	11714	\$6.75
Vinyl glove	11773	\$3.25

TRANSFER EQUIPMENT

Transfer Equipment

Set Size	Part #	Price
Forceps, 3.625 in 100 g - 1 mg	11711	\$5.00
Forceps, 4.75 in	50035	\$43.00
Plastic bar 200 g - 3 kg, screw knob weights	11747	\$21.00
Metal handle 5 kg +, screw knob weights	11712	\$73.00
Metal forceps <i>Not recommended for use with polished weights.</i>	65640	\$21.00
Weight lifter, OIML 2 kg and 5 kg	50037	\$54.00
Tong assembly, 24 cm x 7.5 cm	50000	\$74.00
Tweezers, premium, 140 mm	152414	\$43.00
Tweezers, premium, 220 mm	157109	\$48.50



TRANSFER CART

Transfer Cart

Description	Part #	Price
36.5 x 74.5 x 29 in (927.1 x 1892.3 x 736.6 mm) <i>For use on smooth, level surfaces—especially for moving 500 or 1,000 lb heavy-capacity weights.</i>	11700	\$1,720.00
25 x 37.5 x 14.5 in (635 x 952.5 x 368.3 mm) <i>For use on smooth, level surfaces—for holding up to fifteen 50 lb grip-handle weights.</i>	11702	\$1,970.00

Hook Replacement Parts

Description	Part #	Price
Short hook for 1,000 lb weight	22643	\$45.50
Long hook for 500 lb weight	22644	\$45.50

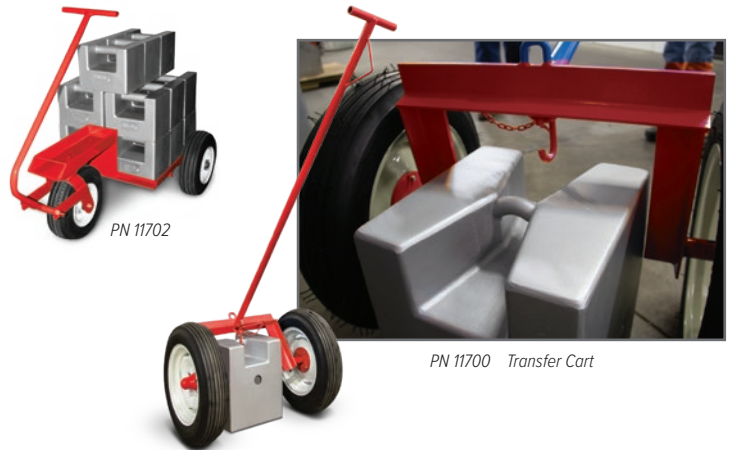

TOUCH-UP PAINT

Touch-up/Repair Paint

Ships UPS ground only

Description	Part #	Price
Aerosol spray (gold)	88561	\$32.00
Aerosol spray (silver)	88562	\$32.00
Aerosol spray (primer)	88563	\$32.00





RICE LAKE

Analytical

130 TA Plus

Legal For Trade

131 TE Enhanced Series

Toploader

132 TS Series Washdown

133 TP Series

134 TC Series

135 Equipoise® Series

A&D WEIGHING

Mass Comparator

136 MC Series

Micro / Semi-Micro

137 Ion BM Series

138 Phoenix GH Series

139 Gemini GR Series

Analytical

140 Ion BM Series

141 Phoenix GH Series

142 Gemini GR Series

143 HR-AZ/A Series

144 Orion HR Series

145 AD-4212A Series

146 Apollo GF Series

147 Apollo GX Series

Legal For Trade

148 GF-P Series

149 FX-i Series

150 EK-i Series

151 EW-i Series

Precision

152 Apollo GX Series

153 Apollo GF Series

154 FX-iWP Series Washdown

155 FX-i Series

156 AD-4212A Series

Toploader

157 FX-i Series

158 Apollo GX Series

159 Apollo GF Series

160 FX-iWP Series Washdown

161 EJ Newton Series

162 EK-i Series

163 EW-i Series

High Capacity

164 GX-M Series

165 GF-M Series

166 GP Series

167 GP Series

Intrinsically Safe

168 EK-AEP Series

Moisture Analyzers

169 MS-70 / MX-50 / MF-50 / ML-50

Static Eliminator

170 AD-1683

OHAUS

Semi-Micro

171 Explorer® Series

Analytical

172 Pioneer® PX Series

173 Explorer® Series

174 Adventurer® Series

Legal For Trade

175 Scout® SJX Series

176 Valor® 7000 Series

177 Adventurer® Series

Precision

178 Adventurer® Series

179 Pioneer® PX Series

180 Explorer® Series

181 Scout® Series

Toploader

182 Pioneer® PX Series

183 Explorer® Series

184 Adventurer® Series

185 Navigator™ XT Series

186 Scout® Series

187 Scout® Series

188 Valor® 3000 Xtreme Series

189 Valor® 3000 Xtreme Series

Washdown

190 Valor® 2000 Series Washdown

191 Compass CX Series

192 Compass CR Series

193 HH Series

194 YA Series

195 Valor® 1000 Series

High Capacity

196 Explorer® Series

Mechanical

197 Triple Beam

198 Harvard Trip Balance

199 Dial-O-Gram® and
Cent-O-Gram®

200 Field Test Scale

200 Heavy Duty Solution

Moisture Analyzer

201 MB Series

SARTORIUS

Ultra-Micro / Micro

202 Cubis® II Series MCA

203 Cubis® II Series MCE

Semi-Micro

204 Cubis® II MCA Series

205 Cubis® II MCE Series

206 Quintix / Secura Series

Analytical

207 Practum / Quintix /
Secura Series

208 Cubis® II MCA Series

209 Cubis® II MCE Series

210 Entris II Series Basic Essential

211 Entris II Series Basic Advanced

Legal For Trade

212 Secura Series

213 Entris II Series Basic Essential

Precision

214 Cubis® II Series MCA

215 Cubis® II Series MCE

216 Entris II Series Basic Essential

217 Entris II Series Basic Advanced

218 Practum / Quintix / Secura
Series

219 Practum / Quintix / Secura
Series

Toploader

220 Cubis® II Series MCA

221 Cubis® II Series MCE

222 Entris II Series Basic Essential

223 Entris II Series Basic Advanced

Moisture Analyzer

224 MA35, MA37 and MA160 Series

ACCESSORIES

225 AbleCable®

226 Go-Between™

227 Kasota Stone Balance Slab

227 Kasota Stone Balance Table

227 Granite Clean Room Table

228 Anti-Vibration Pad

228 Scoops

229 Static Controlw

ANALYTICAL TA PLUS

Standard Features

- Internal calibration
- Anti-electrostatic 360° transparent windshield
- Eight-digit, 16.5 mm high liquid crystal display (LCD) with backlight
- Single-touch response setting for environment
- 40-step bar graph display
- RS-232 interface for connecting to printer or PC
- ISO/GLP/GMP compliant printing record
- Underweigh hook included
- Plastic housing

Specifications

Weighing Units

Carat, Pennyweight, Troy Ounce, Decimal Ounce, Decimal Pound (See technical manual for complete listing)

Operating Modes

Counting, Percentage, Limit Function (Checkweighing), Specific Gravity

Power

120 VAC adapter

RS232

Baud rate - 1200/2400/4800/9600/19200 bps, 8/7 data bits, Parity bit-None/Odd/Even

Calibration Weight

TA Plus-124: 120 g
TA Plus-224: 220 g

Operating Temperature

50° F to 86° F (10° C to 30° C) 80% RH or lower

Est. Weight

6.4 lb (2.9 kg)

Warranty

Five-year limited warranty

Return Policy

Rice Lake Standard Policy

Model	Capacity	Readability	Repeatability	Linearity	Pan Size	Weighing Chamber	Dimensions	Part #	List Price
TA Plus-124	120 g	0.0001 g	1 division	1 division	Ø 3.15 in (80 mm)	225 mm H × 213 mm W × 213 mm D	11 × 7.9 × 12 in (290 × 200 × 306 mm)	196569	\$2,035.00
TA Plus-224	220 g	0.0001 g	1 division	1 division	Ø 3.15 in (80 mm)	225 mm H × 213 mm W × 213 mm D	11 × 7.9 × 12 in (290 × 200 × 306 mm)	196570	\$2,055.00

Options/Accessories

Part #	Description	Price
108255	115 VAC adapter	\$52.00
108256	230 VAC adapter	\$79.00
108257	In-use cover	\$52.00
107398	Additional operating manual	\$16.00
75351	WinWedge® Tal software	\$345.00
66535	Null modem cable	\$46.00
119919	AbleCable, requires null modem cable PN 66535	\$190.00



Standard Features

- External weight calibration
- Seven-segment (main)/16-segment (sub) display
- Selectable modes: Weighing, Counting, Percentage, Coefficient, Specific Gravity, Statistics, Animal and Formulation
- Mono-metal tuning fork technology (MMTF) provides quick response and stability
- 30-step bar graph display
- AA dry-cell port, (150 hours continuous use with LCD backlight and communication signal ON)
- RS-232 interface for connecting to printer or PC
- Glass breeze break (TE-223 and TE-623 only)

Specifications

Weighing Units

Milligram, Gram, Ounce, Pound, Carat, Pennweight, Troy Ounce (See technical manual for complete listing)

Operating Modes

Weighing, Counting, Percentage, Coefficient, Specific Gravity, Statistics, Animal, Formulation

Power

100-240 VAC adapter, AA dry cell (batteries not included)

Operating Temperature

41° F to 95° F (5° C to 35° C)

Est. Weight

TE-223 / 322NC: 6.5 lb (3 kg)
TE-623 / 3202 / 6202 / 15001 / 1501NC / 8200NC: 6.0 lb (2.7 kg)

Warranty

Five-year limited warranty

Return Policy

Rice Lake Standard Policy

Approvals

NTEP Certified CC 17-104
Measurement Canada AM-6169



Model	Capacity	Resolution	NTEP Resolution	Pan Size	Weighing Chamber	Dimensions	Part #	List Price
NTEP Certified Only								
TE-223	220 g	0.001 g	0.01 g	4.6 in (118 mm)	226 mm H x 150 mm W x 150 mm D	10.6 x 8.1 x 11.8 in (270 x 208 x 301 mm)	187600	\$1,082.00
TE-623	620 g	0.001 g	0.01 g	4.6 in (118 mm)	N/A	10.6 x 8.1 x 11.8 in (270 x 208 x 301 mm)	186030	\$1,422.00
TE-3202	3,200 g	0.01 g	0.1 g	6.3 x 7.1 in (160 x 180 mm)	N/A	10.4 x 7.5 x 3.4 in (265 x 191.5 x 86 mm)	186035	\$1,180.00
TE-6202	6,200 g	0.01 g	0.1 g	6.3 x 7.1 in (160 x 180 mm)	N/A	10.4 x 7.5 x 3.4 in (265 x 191.5 x 86 mm)	186036	\$1,450.00
TE-15001	15,000 g	0.1 g	1.0 g	6.3 x 7.1 in (160 x 180 mm)	N/A	10.4 x 7.5 x 3.4 in (265 x 191.5 x 86 mm)	186037	\$1,135.00
NTEP Certified and Measurement Canada Approved								
TE-322NC	320 g	0.01 g	0.01 g	4.6 in (118 mm)	226 mm H x 150 mm W x 150 mm D	10.6 x 8.1 x 11.8 in (270 x 208 x 301 mm)	204688	\$1,050.00
TE-1501NC	1,500 g	0.1 g	0.1 g	6.3 x 7.1 in (160 x 180 mm)	N/A	10.4 x 7.5 x 3.4 in (265 x 191.5 x 86 mm)	204689	\$1,145.00
TE-8200NC	8,200 g	1 g	1 g	6.3 x 7.1 in (160 x 180 mm)	N/A	10.4 x 7.5 x 3.4 in (265 x 191.5 x 86 mm)	204690	\$1,150.00

Options/Accessories

Part#	Description	Price
186074	Power supply 100-240 VAC, 50-60 Hz	\$67.00
186075	In-use dust cover 623 g models and lower	\$27.00
186076	In-use dust cover 3,200 g models and higher	\$27.00
186077	Specific Density Measurement Kit	\$620.00
186079	Ethernet TCP/IP option card	\$620.00



TOPLOADER

TS Series Washdown

Standard Features

- Stainless steel, IP65 top housing
- Large, 18 mm liquid crystal display (LCD) with backlight
- Selectable modes
- 13 units of measurement
- Mono-metal tuning fork sensor (MMTS) provides quick response and stability
- Washdown with IP65 rating
- 115 VAC adapter included (230 VAC optional)
- Semi-automatic calibration, external weight
- RS-232 interface for connecting to printer or PC

OPTIONS:

- Battery holder
- Underweigh hook
- Waterproof RS-232 cable

Specifications**Weighing Units**

Carat, Pennyweight, Troy Ounce, Decimal Ounce, Decimal Pound (See technical manual for complete listing)

Operating Modes

Weight, Count, Percentage, Limit Function (Checkweighing)

Power

120 VAC (adapter included)

Battery Option

Nickel Cadmium battery, 12-hour run time, 24-hour charge time

RS-232 Baud Rate

1200/2400/2800/9600;
Data bits - 8, Connector - DIN 5-Pin

Calibration Weight

TP-620: 600 g
TP-6200: 6,000 g
TP-8200: 8,000 g

Operating Temperature

41° F to 95° F (5° C to 35° C)

Est. Weight

6.2 lb (2.8 kg)

Warranty

Five-year limited warranty

Return Policy

Rice Lake Standard Policy

Model	Capacity	Resolution	Calibration	Part #	List Price
TS-620	620 g	0.01 g	600 g	108156	\$1,365.00
TS-6200	6,200 g	0.1 g	6,000 g	108157	\$1,475.00
TS-8200	8,200 g	0.1 g	8,000 g	112182	\$1,550.00

Options/Accessories

Part #	Description	Price
108499	AC adapter, multi-range 110:230 VAC, 6 VDC	\$52.00
72440	9-pin D-sub F-25-Pin D-sub connector	\$67.00
22436	9-pin D-sub F to blunt end	\$67.00
66535	Null modem cable	\$46.00
119064	Slimline adapter, null modem gender changer	\$11.00
109236	Underweigh hook	\$27.00
109238	Waterproof RS-232 cable	\$360.00
109050	Additional operating manual	\$16.00
112611	Battery operator manual	\$6.00
112516	Battery holder option, requires Four AA batteries (not included)	\$105.00
119919	AbleCable, requires null modem cable PN 66535	\$190.00



PN 108499 Multi-range AC adapter and multi-plug



Standard Features

- External weight calibration
- Large, 16.5 mm-high backlit liquid crystal display (LCD)
- Mono-metal tuning fork sensor (MMTS) provides quick response and stability
- 20-step bar graph display
- One part in 620,000 resolution
- RS-232 interface for connecting to printer or PC
- Plastic housing on models <1,000 g
- Plastic top and die cast bottom on models >1,000 g

OPTIONS

- Rechargeable battery
- Under-hook weighing

Specifications

Weighing Units:

Carat, Pennyweight, Troy Ounce, Decimal Ounce, Decimal Pound (See technical manual for complete listing)

Operating Modes:

Weight, Count, Percentage, Limit Function (Check-weighing)

Power:

120 VAC (adapter included)

Battery Option:

Nickel Cadmium battery, 12-hour run time, 24-hour charge time

RS-232 Baud Rate:

1200/2400/2800/9600; Data bits - 8, Connector - DIN 5-Pin

Calibration Weight:

TP-220: 200 ?g
TP-820: 800 ?g
TP-3200: 3,000 ?g
TP-8200: 8,000 ?g
TP-12K: 12,000 ?g

Operating Temperature:

41° F to 95° F (5° C to 35° C)

Est. Weight:

6.2 lb (2.8 kg)

Warranty:

Five-year limited

Return Policy:

Rice Lake Standard Policy

Model	Capacity	Readability	Repeatability	Linearity	Pan Size	Weighing Chamber	Dimensions	Part #	List Price
TP-220	220 g	0.001 g	1 division	1 division	Ø 4.6 in (116.8 mm)	170mm W × 140 mm D × 95 mm H	9.2 × 7.1 × 6.6 in (including windshield) (235 × 182 × 170 mm)	107244	\$1,050.00
TP-820	820 g	0.01 g	1 division	1 division	6.6 in × 5.5 in (167.6 × 139.7 mm)	N/A	9.2 × 7.1 × 2.9 in (235 × 182 × 75 mm)	107245	\$1,050.00
TP-3200	3,200 g	0.01 g	1 division	1 division	7 in × 6.2 in (177.8 × 157.5 mm)	N/A	10.1 × 7.5 × 3.4 in (265 × 192 × 87 mm)	107246	\$1,190.00
TP-8200	8,200 g	0.1 g	1 division	1 division	7 in × 6.2 in (177.8 × 157.5 mm)	N/A	10.1 × 7.5 × 3.4 in (265 × 192 × 87 mm)	107247	\$1,050.00
TP-12K	12,000 g	0.1 g	1 division	1 division	7 in × 6.2 in (177.8 × 157.5 mm)	N/A	10.1 × 7.5 × 3.4 in (265 × 192 × 87 mm)	107248	\$1,210.00

Options/Accessories

Part #	Description	Price
107249	Rechargeable battery ≤TP-820	\$105.00
107237	Rechargeable battery ≥TP-3200	\$105.00
107250	In-use dust cover ≥TP-3200	\$27.00
107240	In-use dust cover ≤TP-820	\$27.00
109236	Underweigh hook ≤TP-820	\$27.00
109292	Underweigh hook ≥TP-3200	\$27.00
42566	115 VAC adapter/12 VDC	\$68.00
42168	230 VAC adapter	\$74.00
107251	Additional operating manual	\$16.00
75351	WinWedge® Tal software	\$345.00
115303	5-pin to 9-pin DB female RS-232 cable	\$98.00



TOPLOADER TC Series

Standard Features

- Large, 16.5 mm-high, backlit liquid crystal display (LCD)
- 12 units of measurement
- Mono-metal tuning fork sensor (MMTF) provides quick response and stability
- 20-step bar graph display
- Semi-automatic calibration, external weight
- Plastic housing on models <1000 g
- Plastic top and die cast bottom on models >1000 g

Specifications

Weighing Units:

Carat, Pennyweight, Troy Ounce, Decimal Ounce, Decimal Pound (See technical manual for complete listing)

Operating Modes:

Weight, Count, Percentage, Limit Function (Checkweighing)

Power:

115 VAC adapter included (230 VAC optional)

Operating Temperature :

41 °F to 95 °F (5 °C to 35 °C)

Calibration Weight:

TC-620: 600 g
TC-1200: 1,200 g
TC-4200: 4,000 g
TC-6200: 6,200 g

Est. Weight:

TC-620: 2.9 lb (1.3 kg)
TC-1200: 2.9 lb (1.3 kg)
TC-4200: 5.9 lb (2.7 kg)
TC-6200: 5.9 lb (2.7 kg)

Warranty:

Five-year limited

Return Policy:

Rice Lake Standard Policy

Model	Capacity	Readability	Repeatability	Linearity	Pan Size	Dimensions	Part #	List Price
TC-620	620 g	0.01 g	1 division	1 division	Ø 5.5 in (139.7 mm)	9.2 × 7.1 × 2.9 in (234 × 180 × 74 mm)	107232	\$737.00
TC-1200	1,200 g	0.1 g	1 division	1 division	6.7 × 5.6 in (170.2 × 142.2 mm)	10.4 × 7.5 × 3.4 in (264 × 191 × 86 mm)	107233	\$675.00
TC-4200	4,200 g	0.1 g	1 division	1 division	7 × 6.2 in (177.8 × 157.5 mm)	10.4 × 7.5 × 3.4 in (264 × 191 × 86 mm)	107234	\$737.00
TC-6200	6,200 g	0.1 g	1 division	1 division	7 × 6.2 in (177.8 × 157.5 mm)	10.4 × 7.5 × 3.4 in (264 × 191 × 86 mm)	107235	\$795.00

Options/Accessories

Part#	Description	Price
107236	Rechargeable battery TC-620, TC-1200, 32 hr	\$105.00
107237	Rechargeable battery TC-4200, TC-6200, 32 hr	\$105.00
107238	RS-232 option with DIN-5-Pin connector (not compatible with battery option) (TC-620, TC-1200)	\$130.00
107239	RS-232 option with DIN-5-Pin connection (not compatible with battery option) (TC-4200,TC-6200)	\$130.00
107240	In-use dust cover, 620 g to 1,200 g	\$27.00
107250	In-use dust cover, 4,200 g to 6,200 g	\$27.00
109236	Underweigh hook TC-620, TC-1200	\$27.00
109292	Underweigh hook TC-4200, TC-6200	\$27.00
42566	120 VAC adapter/12 VDC	\$68.00
42168	230 VAC adapter	\$74.00
107243	Additional operating manual	\$16.00
75351	WinWedge® software	\$345.00
115303	5-pin DIN to DB9F RS-232 cable	\$98.00
115148	RS-232 manual	\$6.00



Standard Features

- LCD display
- Quick response
- Accumulation, counting and percentage modes
- 13 different units of measure
- Detachable enclosed weighing chamber (in capacities =1 kg)
- Battery operation for up to 40 hours of continuous use (without backlight)
- RS-232 interface for connecting to printer or PC
- Plastic enclosure

Specifications

Weighing Units

Gram, Ounce, Pound, Carat, Pennweight, Troy Ounce, Grain (See technical manual for complete listing)

Operating Modes

Weighing, Percent Weighing, Parts Counting, Accumulation

Power

AC adapter (12 V/500 mA); internal rechargeable battery (6 V/1.2 Ah)

Stabilization Time

2 seconds

Operating Temperature

32° F to 104° F (0° C to 40° C)

Calibration Weight

EQ-300: 300 g, EQ-600: 600 g, EQ-1500: 1,500 g
EQ-3000: 3,000 g, EQ-6000: 6,000 g

Est. Weight

6.6 lb (3 kg)

Warranty

One-year limited warranty

Return Policy

Rice Lake Standard Policy

Battery Life

Up to 40 hours of continuous use (without backlight)

Approval

CE Marked



Model	Capacity	Readability	Repeatability	Linearity	Weighing Chamber	Pan Size	Part #	List Price
EQ-300	300 g	0.01g	0.01g	0.02 g	6.7 × 5.7 × 3.1in (170 × 145 × 80 mm)	Ø 4.7 in (Ø 120 mm)	165338	\$305.00
EQ-600	600 g	0.02 g	0.02 g	0.04 g	6.7 × 5.7 × 3.1in (170 × 145 × 80 mm)	Ø 4.7 in (Ø 120 mm)	165339	\$305.00
EQ-1500	1,500 g	0.05 g	0.05 g	0.1g	N/A	4.8 × 5.6 in (122 × 142 mm)	165340	\$305.00
EQ-3000	3,000 g	0.1g	0.1g	0.2 g	N/A	4.8 × 5.6 in (122 × 142 mm)	165341	\$305.00
EQ-6000	6,000 g	0.2 g	0.2 g	0.4 g	N/A	4.8 × 5.6 in (122 × 142 mm)	165342	\$305.00

Options/Accessories

Part#	Description	Price
41279	Printer cable, DB9M to 25-Pin M	\$70.00
103142	SP742 dot matrix printer, tear bar	\$520.00
119919	AbleCable RS-232/USB cable (requires 130789)	\$190.00
130789	Slim line null modem adapter	\$13.00
131135	Aluminum case	\$103.00
165183	AC adapter, 110-240 VAC, interchangeable plugs	\$46.00



PN 165183 Multi-range AC adapter and multi-plug



MASS COMPARATOR

MC Series

Standard Features

- Super hybrid sensor technology
- Bright VFD display
- Manage ASTM and OIML weights
- Underhook weighing
- Built-in calibration weight
- GLP/LIM/ISO compliant
- RS-232 interface for connecting to printer or PC

Specifications

Weighing Units

Gram, Ounce, Pound, Carat, Pennyweight, Troy Ounce, Pound/Ounce (See technical manual for complete listing)

Operating Modes

Weighing, Percentage, Comparator

Power

120/240 AC adapter

Stabilization Time

5 seconds

Sensitivity Drift (10° C to 30° C)

MC-1000S, MC-6100, MC-10K - ±2 ppm/° C
MC-30K - ±3 ppm/0° C

Operating Temperature

41° F to 104° F (5° C to 40° C) 85% RH or less (no condensation)

Calibration Weight

MC-1000S: 1,000 g
MC-6100: 6,000 g
MC-10K: 10 kg
MC-30K: 30 kg

Est. Weight

MC-1000S - 4.6 kg
MC-6100 - 5.1 kg
MC-10K and MC-30K - 9.3 kg

Warranty

Five-year limited warranty

Return Policy

A&D Weighing Standard Policy - restock fee may apply

Model	Capacity	Readability	Repeatability	Linearity	Pan Size	Dimensions	Part #	List Price
MC-1000S	1,100 g	0.1 mg	0.0005 g / 1 kg / 0.0004 g / 500 g	±0.002 g	5.04 × 5.04in 128 × 128 mm	8.27 × 12.48 × 3.39in 210 × 317 × 86 mm	151262	\$6,470.00
MC-6100	6,100 g	0.001 g	0.004 g / 5 kg / 0.0015 g / 2 kg	±0.02 g	5.79 × 5.79in 147 × 147 mm	10.63 × 8.27in 270 × 210 mm	151263	\$6,475.00
MC-10K	10.1 kg	0.001 g	0.005 g / 10 kg / 0.004 g / 5 kg	±0.03 g	10.63 × 8.27in 270 × 210 mm	11.81 × 13.80 × 4.37in 300 × 355 × 111 mm	151264	\$7,750.00
MC-30K	31 kg	0.01 g	0.015 g / 20 kg	±0.2 g	10.63 × 8.27in 270 × 210 mm	10.63 × 10.63in 270 × 210 mm	151265	\$7,750.00

Options/Accessories

Part#	Model #	Description	Price
151266	AX-MC1000PAN	Auto center pan, MC-1000S	\$1,205.00
151267	AX-MC6100PAN	Auto center pan, MC-6100	\$1,205.00
151268	AX-MC10K-30KPAN	Auto center pan, MC-10/30K	\$1,540.00
151247	AD-1688	Data logger	\$320.00
97649	TB:648	AC adapter (120 V/220 V)	\$45.00
97695*	GX-04	Comparator output, factory installed	\$274.00
97696*	GX-06	Analog output, factory installed	\$866.00
97699	GX-12	Animal weigh pan	\$191.00
97700	GX-13	Density determination for MC-1000S	\$660.00
97607	AD-1682	External rechargeable battery pack	\$710.00
97612	SW-128	Foot switch	\$85.00
196128	AD-8127	Impact dot matrix, statistical printer, includes cable	\$890.00

* Only one option may be installed and requires factory installation



Standard Features

- Built-in fanless static eliminator
- Underhook weighing
- Anti-static glass
- Weighing chamber
- Built-in motorized calibration weight
- One touch environmental filters
- GLP/LIM/ISO compliant
- RS-232C and WinCT© software standard
- AD-1688 Weighing Data Logger included

Specifications

Weighing Units

Carat, Pennyweight, Troy Ounce (See technical manual for complete listing)

Operating Modes

Percentage, Counting

Power

120/240 AC Adapter

Stabilization Time

BM-20: 10 seconds (typically)
 BM-22: 8 to 10 seconds
 BM-252: 8 seconds

Sensitivity Drift (10° C to 30° C)

±2 ppm/° C (when automatic self-calibration is not used)

Calibration Weight

BM-20 and BM-22: 20 g
 BM-252: 200 g

Operating Temperature

41° F to 104° F (5° C to 40° C), 85% RH or less (no condensation)

Est. Weight

10 kg (ships by motor freight)

Warranty

Five-year limited warranty

Return Policy

A&D Weighing Standard Policy - restock fee may apply

Model	Capacity	Readability	Repeatability	Linearity	Pan Size	Dimensions	Part #	List Price
BM-20	22 g	0.000001 g	0.0025 mg	±0.010 mg	25 mm (Ø 0.98 in)	259 × 466 × 326 mm (10.2 × 18.3 × 12.8 in)	150762	\$17,025.00
BM-22	22 g / 5.1 g	0.00001 g / 0.000001 g	0.004 mg / 0.01 mg	±0.010 mg / 0.02 mg	25 mm (Ø 0.98 in)	259 × 466 × 326 mm (10.2 × 18.3 × 12.8 in)	150763	\$16,165.00
BM-252	250 g	0.00001 g	0.03 mg	±0.010 mg	90 mm (Ø 3.6 in)	259 × 466 × 326 mm (10.2 × 18.3 × 12.8 in)	150765	\$8,610.00

Options/Accessories

Part#	Model#	Description	Price
150769	BM-08	Balance OPT, Ethernet BM	\$299.00
97606	AD-1653	Density determination kit (BM-252/200/300/500 only)	\$579.00
97609	AD-8922A	Remote controller	\$650.00
97608	AD-8920A	Universal remote display	\$275.00
97612	SW:128	Foot switch	\$85.00
97649	TB:648	AC adapter (120 V/220 V)	\$45.00
196128	AD-8127	Impact dot matrix, statistical printer, includes cable	\$890.00



MICRO / SEMI-MICRO

PHOENIX GH Series

Standard Features

- Simple and easy to operate, adapts to your environment
- GLP/GMP/GCP/ISO compliant which outputs the calibration data and ID number of the balance for calibration confirmation to the AD-8121B printer
- Internal calibration mass; full digital calibration
- System diagnostic to alert operator of abnormal weighing conditions
- Weighing chamber
- Underhook weighing
- RS-232 interface for connecting to printer or PC
- Data memory function
- Time and date function
- WinCT[®]; communication tools software
- Liquid crystal display (LCD)

Specifications

Weighing Units

Carat, Pennyweight, Troy Ounce, Decimal Ounce
(See technical manual for complete listing)

Operating Modes

Percentage, Counting

Power

120 V AC (AC Adapter) 50 Hz/60 Hz, 11 VA (110, 220, 240 available by special order)

Stabilization Time

Approx. 3.5 sec (0.1 mg)/8 sec (0.01 mg)

Sensitivity Drift (10° C to 30° C)

±2 ppm/° C (when automatic self-calibration is not used)

Calibration Weight

20 g/50 g/100 g/200 g

Operating Temperature

41° F to 104° F (5° C to 40 C) 85% RH or less
(no condensation)

Est. Weight

Approx. 18 lb (8.2 kg)

Warranty

Five-year limited warranty

Return Policy

A&D Weighing Standard Policy -
restock fee may apply

Model	Capacity	Readability	Repeatability	Linearity	Weighing Chamber	Pan Size	Dimensions	Part #	List Price
GH-202	220 g / 51 g	0.0001 / 0.00001 g	±0.2 mg / ±0.03 mg	0.1 mg / 0.02 mg	164 × 149 × 251 mm (6.45 × 4.87 × 9.88 in)	90 mm (Ø 3.6 in)	217 × 442 × 316 mm (8.54 × 17.4 × 12.24 in)	97601	\$5,350.00
GH-252	250 g / 101 g	0.0001 / 0.00001 g	±0.2 mg / ±0.10 mg	0.1 mg / 0.03 mg	164 × 149 × 251 mm (6.45 × 4.87 × 9.88 in)	90 mm (Ø 3.6 in)	217 × 442 × 316 mm (8.54 × 17.4 × 12.24 in)	97602	\$5,895.00

Options/Accessories

Part #	Model #	Description	Price
97604	GH-08	Ethernet option for GH	\$299.00
97605	AD-100-2	Anti-theft device	\$77.00
97606	AD-1653	Density determination kit	\$579.00
97607	AD-1682	Rechargeable battery pack, external	\$710.00
97608	AD-8920A	Universal remote display	\$275.00
97609	AD-8922A	Remote controller	\$650.00
97610	AD-1683	Static eliminator	\$1,275.00
151247	AD-1688	Data logger	\$320.00
97612	SW:128	Foot switch	\$85.00
97649	TB:648	AC adapter (120 V/220 V)	\$45.00



MICRO / SEMI-MICRO
GEMINI GR Series

Standard Features

- GLP/GMP/GCP/ISO compliant software outputs the calibration data and ID number of the balance for calibration confirmation to the AD-8121B printer
- Easy access door system
- Automatic self-calibration
- Data memory function
- Weighing chamber
- Underhook weighing
- Internal calibration
- Liquid Crystal Display (LCD)
- RS-232 interface for connecting to printer or PC
- WinCT© communication tools software

Specifications

Weighing Units

Carat, Pennyweight, Troy Ounce, Decimal Ounce
 (See technical manual for complete listing)

Operating Modes

Percentage, Counting

Power

120 V AC (AC Adapter) 50Hz/60 Hz, 11 VA (110, 220, 240 VAC adapter by special order)

Stabilization Time

Approx. 3.5 sec (0.1 mg)/8 sec (0.01 mg)

Sensitivity Drift (10° C to 30° C)

±2 ppm/° C (when automatic self-calibration is not used)

Calibration Weight

100 g/200 g

Operating Temperature

41° F to 104° F (5° C to 40° C) 85% RH or less
 (no condensation)

Est. Weight

Approx. 13.2 lb (6.0 kg)

Warranty

Five-year limited warranty

Return Policy

A&D Weighing Standard Policy -
 restock fee may apply

Model	Capacity	Readability	Repeatability	Linearity	Weighing Chamber	Pan Size	Dimensions	Part #	List Price
GR-202	210 / 42 g	0.0001 / 0.00001 g	0.0001 / 0.00002 g	±0.0002 / ±0.00003 g	7.01 × 6.5 × 9.17 in (178 × 160 × 233 mm)	85 mm (Ø 3.3 in)	249 × 330 × 327 mm (9.8 × 12.99 × 12.87 in)	97628	\$4,950.00

Options/Accessories

Part #	A&D Model #	Description	Price
97605	AD-100-2	Anti-theft device	\$77.00
97606	AD-1653	Density determination kit	\$579.00
97607	AD-1682	Rechargeable battery pack	\$710.00
97608	AD-8920A	Universal remote display	\$275.00
97609	AD-8922A	Remote controller	\$650.00
97610	AD-1683	Static eliminator	\$1,275.00
97612	SW:128	Foot switch	\$85.00
97649	TB:648	AC adapter (120 V/220 V)	\$45.00
151247	AD-1688	Data logger	\$320.00
196128	AD-8127	Impact dot matrix, statistical printer, includes cable	\$890.00



ANALYTICAL ION BM Series

Standard Features

- Built-in fanless static eliminator
- Underhook weighing
- Anti-static glass
- Weighing chamber
- Built-in motorized calibration weight
- One touch environmental filters
- GLP/LIM/ISO compliant
- RS-232C and WinCT[®] software standard
- AD-1688 Weighing Data Logger included

Specifications

Weighing Units

Carat, Pennyweight, Troy Ounce (See technical manual for complete listing)

Operating Modes

Percentage, Counting

Power

120/240 AC Adapter

Stabilization Time

BM-200, BM-300, BM-500: Approx. 3.5 seconds

Sensitivity Drift (10° C to 30° C)

±2 ppm/° C (when automatic self-calibration is not used)

Calibration Weight

BM-200: 200 g
BM-300: 300 g
BM-500: 500 g

Operating Temperature

41° F to 104° F (5° C to 40° C), 85% RH or less (no condensation)

Est. Weight

10 kg (ships by motor freight)

Warranty

Five-year limited warranty

Return Policy

A&D Weighing Standard Policy - restock fee may apply

Model	Capacity	Readability	Repeatability	Linearity	Pan Size	Dimensions	Part #	List Price
BM-200	220 g	0.0001 g	0.1 mg	±0.2 mg	90 mm (Ø 3.6 in)	259 × 466 × 326 mm (10.2 × 18.3 × 12.8 in)	150766	\$6,750.00
BM-300	320 g	0.0001 g	0.2 mg	±0.3 mg	90 mm (Ø 3.6 in)	259 × 466 × 326 mm (10.2 × 18.3 × 12.8 in)	150767	\$7,105.00
BM-500	520 g	0.0001 g	0.2 mg	±0.5 mg	90 mm (Ø 3.6 in)	259 × 466 × 326 mm (10.2 × 18.3 × 12.8 in)	150768	\$7,500.00

Options/Accessories

Part #	Model #	Description	Price
150769	BM-08	Balance OPT, Ethernet BM	\$299.00
97606	AD-1653	Density determination kit	\$579.00
97609	AD-8922A	Remote controller	\$650.00
97608	AD-8920A	Universal remote display	\$275.00
97612	SW:128	Foot switch	\$85.00
97649	TB:648	AC adapter (120 V/220 V)	\$45.00
196128	AD-8127	Impact dot matrix, statistical printer, includes cable	\$890.00



Standard Features

- Simple and easy to operate, adapts to your environment
- GLP/GMP/GCP/ISO compliant which outputs the calibration data and ID number of the balance for calibration confirmation to the AD-8121B printer
- Internal calibration mass; full digital calibration
- System diagnostic to alert operator of abnormal weighing conditions
- Weighing chamber
- Underhook weighing
- RS-232 interface for connecting to printer or PC
- Data memory function
- Time and date function
- WinCT©; communication tools software
- Liquid crystal display (LCD)

Specifications

Weighing Units

Carat, Pennyweight, Troy Ounce, Decimal Ounce
(See technical manual for complete listing)

Operating Modes

Percentage, Counting

Power

120 V AC (AC Adapter) 50 Hz/60 Hz, 11 VA
(110, 220, 240 available by special order)

Stabilization Time

Approx. 3.5 sec (0.1 mg)/8 sec (0.01 mg)

Sensitivity Drift (10° C to 30° C)

±2 ppm/° C (when automatic self-calibration is not used)

Calibration Weight

GH-120: 50 g/100 g
GH-200: 100 g/200 g
GH-300: 100 g/200 g/300 g

Operating Temperature

41° F to 104° F (5° C to 40 C) 85% RH or less
(no condensation)

Est. Weight

Approx. 18 lb (8.2 kg)

Warranty

Five-year limited warranty

Return Policy

A&D Weighing Standard Policy - restock fee may apply

Model	Capacity	Readability	Repeatability	Linearity	Weighing Chamber	Pan Size	Dimensions	Part #	List Price
GH-120	120 g	0.0001 g	±0.2 mg	0.1 mg	164 × 149 × 251 mm (6.45 × 4.87 × 9.88 in)	90 mm (Ø 3.6 in)	217 × 442 × 316 mm (8.54 × 17.4 × 12.24 in)	97597	\$3,540.00
GH-200	220 g	0.0001 g	±0.2 mg	0.1 mg	164 × 149 × 251 mm (6.45 × 4.87 × 9.88 in)	90 mm (Ø 3.6 in)	217 × 442 × 316 mm (8.54 × 17.4 × 12.24 in)	97599	\$4,010.00
GH-300	320 g	0.0001 g	±0.3 mg	0.2 mg	164 × 149 × 251 mm (6.45 × 4.87 × 9.88 in)	90 mm (Ø 3.6 in)	217 × 442 × 316 mm (8.54 × 17.4 × 12.24 in)	97600	\$4,765.00

Options/Accessories

Part#	Model#	Description	Price
97604	GH-08	Ethernet option for GH	\$299.00
97605	AD-100-2	Anti-theft device	\$77.00
97606	AD-1653	Density determination kit	\$579.00
97607	AD-1682	Rechargeable battery pack, external	\$710.00
97608	AD-8920A	Universal remote display	\$275.00
97609	AD-8922A	Remote controller	\$650.00
97610	AD-1683	Static eliminator	\$1,275.00
151247	AD-1688	Data logger	\$320.00
97612	SW:128	Foot switch	\$85.00
97649	TB:648	AC adapter (120 V/220 V)	\$45.00



ANALYTICAL GEMINI GR Series

Standard Features

- GLP/GMP/GCP/ISO compliant software outputs the calibration data and ID number of the balance for calibration confirmation to the AD-8121B printer
- Easy access door system
- Automatic self-calibration
- Data memory function
- Weighing chamber
- Underhook weighing
- Internal calibration
- Liquid Crystal Display (LCD)
- RS-232 interface for connecting to printer or PC
- WinCT[®] communication tools software

Specifications

Weighing Units

Carat, Pennyweight, Troy Ounce, Decimal Ounce
(See technical manual for complete listing)

Operating Modes

Percentage, Counting

Power

120 V AC (AC Adapter) 50Hz/60 Hz, 11 VA
(110, 220, 240 VAC adapter by special order)

Stabilization Time

Approx. 3.5 sec (0.1 mg)/8 sec (0.01 mg)

Sensitivity Drift (10° C to 30° C)

±2 ppm/° C (when automatic self-calibration is not used)

Calibration Weight

GR-120: 50 g/100 g
GR-200: 100 g/200 g
GR-300: 200 g/300 g

Operating Temperature

41° F to 104° F (5° C to 40° C) 85% RH or less
(no condensation)

Est. Weight

13.2 lb (6.0 kg)

Warranty

Five-year limited warranty

Return Policy

A&D Weighing Standard Policy -
restock fee may apply

Model	Capacity	Readability	Repeatability	Linearity	Weighing Chamber	Pan Size	Dimensions	Part #	List Price
GR-120	120 g	0.0001 g	0.0001 g	±0.0002 g	7.01 × 6.5 × 9.17 in (178 × 160 × 233 mm)	85 mm (Ø 3.3 in)	249 × 330 × 327 mm (9.8 × 12.99 × 12.87 in)	97625	\$3,075.00
GR-200	210 g	0.0001 g	0.0001 g	±0.0002 g	7.01 × 6.5 × 9.17 in (178 × 160 × 233 mm)	85 mm (Ø 3.3 in)	249 × 330 × 327 mm (9.8 × 12.99 × 12.87 in)	97626	\$3,495.00
GR-300	310 g	0.0001 g	0.0001 g	±0.0002 g	7.01 × 6.5 × 9.17 in (178 × 160 × 233 mm)	85 mm (Ø 3.3 in)	249 × 330 × 327 mm (9.8 × 12.99 × 12.87 in)	97627	\$4,350.00

Options/Accessories

Part #	A&D Model #	Description	Price
97605	AD-100-2	Anti-theft device	\$77.00
97606	AD-1653	Density determination kit	\$579.00
97607	AD-1682	Rechargeable battery pack	\$710.00
97608	AD-8920A	Universal remote display	\$275.00
97609	AD-8922A	Remote controller	\$650.00
97610	AD-1683	Static eliminator	\$1,275.00
97612	SW:128	Foot switch	\$85.00
97649	TB:648	AC adapter (120 V/220 V)	\$45.00
151247	AD-1688	Data logger	\$320.00
196128	AD-8127	Impact dot matrix, statistical printer, includes cable	\$890.00



Standard Features

- Fast stabilization time
- One-touch calibration in HR-AZ models
- Compact size
- Weighing chamber
- Rotary sliding doors
- Removable breeze break with anti-static coating
- GLP/GMP/GCP/ISO compliant

Specifications

Weighing Units

Carat, Pennyweight, Troy Ounce, Decimal Ounce
(See technical manual for complete listing)

Operating Modes

Weighing, Percent Weighing, Parts Counting, Density

Power

120/240 AC adapter

Stabilization Time

3 seconds

Operating Temperature

41° F to 104° F (5° C to 40° C), 85% RH or less
(no condensation)

Calibration Weight

HR-100A and HR100AZ: 200g
HR-150A and HR-150AZ: 150g
HR-250A and HR-250AZ: 100g

Est. Weight

8.6 lb (3.9 kg)

Warranty

Five-year limited warranty

Return Policy

A&D Weighing Standard Policy -
restock fee may apply

Model	Capacity	Readability	Repeatability	Linearity	Pan Size	Dimensions	Part #	List Price
HR-100A	102 g	0.0001 g	0.1 mg	± 0.2 mg	90 mm (Ø 3.6 inches)	198 × 294 × 313 mm (7.8 × 11.6 × 12.3 in)	150777	\$1,835.00
HR-100AZ	102 g	0.0001 g	0.1 mg	± 0.2 mg	90 mm (Ø 3.6 inches)	198 × 294 × 313 mm (7.8 × 11.6 × 12.3 in)	150779	\$2,295.00
HR-150A	152 g	0.0001 g	0.1 mg	± 0.2 mg	90 mm (Ø 3.6 inches)	198 × 294 × 313 mm (7.8 × 11.6 × 12.3 in)	150780	\$1,960.00
HR-150AZ	152 g	0.0001 g	0.1 mg	± 0.2 mg	90 mm (Ø 3.6 inches)	198 × 294 × 313 mm (7.8 × 11.6 × 12.3 in)	150781	\$2,410.00
HR-250A	252 g	0.0001 g	<200 mg 0.1 mg / >200 mg 0.2 mg	± 0.3 mg	90 mm (Ø 3.6 inches)	198 × 294 × 313 mm (7.8 × 11.6 × 12.3 in)	150782	\$2,130.00
HR-250AZ	252 g	0.0001 g	<200 mg 0.1 mg / >200 mg 0.2 mg	± 0.3 mg	90 mm (Ø 3.6 inches)	198 × 294 × 313 mm (7.8 × 11.6 × 12.3 in)	150783	\$2,555.00

Options/Accessories

Part #	A&D Model #	Description	Price
151247	AD-1688	Data logger	\$320.00
98027*	FXi-02	Quick USB interface with cable	\$91.00
98028*	FXi-08	Ethernet interface with WIN-CT Plus	\$299.00
98029*	FXi-09	Rechargeable battery	\$335.00
97649	TB:648	AC adapter (120 V/220 V)	\$45.00

*Only one option may be installed and factory installation required



ANALYTICAL ORION HR Series

Standard Features

- GLP/GMP/GCP/ISO compliant software outputs the calibration data and ID number of the balance for calibration confirmation to the AD-8121B printer
 - System diagnostics to alert the operator of abnormal weighing conditions
 - RS-232C bidirectional interface (option for HR-60, HR-120 and HR-200; standard for HR-300i and HR-202i)
 - Weighing chamber
 - Underhook capability for density measurement and weighing magnetic materials
 - Liquid Crystal Display (LCD)
 - WinCT[®] communication tools software
- Note: Orion HR series does have internal calibration*

Specifications

Weighing Units

Carat, Pennyweight, Troy Ounce, Decimal Ounce
(See technical manual for complete listing)

Operating Modes

Percentage, Counting

Power

120 V AC (AC adapter) 50 Hz/60 Hz (110, 220, 240 V
AC adapter available by special order)

Stabilization Time

Approx. 3.5 seconds

Sensitivity Drift (10° C to 30° C)

±2 ppm/° C (when automatic self-calibration
is not used)

Calibration Weight

300 g/200 g/100 g

Operating Temperature

41° F to 104° F (5° C to 40° C) 85% RH or less
(no condensation)

Est. Weight

Approx. 17.6 lb (8.0 kg)

Warranty

Five-year limited warranty

Return Policy

A&D Weighing Standard Policy -
restock fee may apply

Model	Capacity	Readability	Repeatability	Linearity	Weighing Chamber	Pan Size	Dimensions	Part #	List Price
HR-300i	320 g	0.0001 g	±0.0003 mg	0.0002 mg	164 × 149 × 251 mm (6.45 × 5.84 × 9.88 in)	90 mm (Ø 3.6 in)	8.54 × 17.4 × 12.24 in (217 × 442 × 316 mm)	97642	\$4,185.00

Options/Accessories

Part#	A&D Model #	Description	Price
97605	AD-100-2	Anti-theft device	\$77.00
97606	AD-1653	Density determination kit	\$579.00
97607	AD-1682	Rechargeable battery pack	\$710.00
97608	AD-8920A	Universal remote display	\$275.00
97610	AD-1683	Static eliminator	\$1,275.00
97609	AD-8922A	Remote controller	\$650.00
97649	TB:648	AC adapter (120 V/220 V)	\$45.00
151247	AD-1688	Data logger	\$320.00
196128	AD-8127	Impact dot matrix, statistical printer, includes cable	\$890.00



ANALYTICAL AD-4212A Series

Standard Features

- Comparator output (Hi/OK/Lo) feature for manual or automatic operation as well as buzzer function
- GLP/GMP compliant software output
- Breeze break for maximum accuracy and fastest response
- Standard calibration weight
- Simple operator reference card provided
- Multi-weighing units
- Time and date clock function
- Data memory function for weighing, calibration, counting and Hi/OK/Lo values
- Super Hybrid Sensor Technology (SHS)
- WinCT[®] communication tools software
- RS-232 interface for connecting to printer or PC

Specifications

Weighing Units

Milligram, Ounce, Carat, Pennyweight, Troy Ounce, Grain (See technical manual for complete listings)

Operating Modes

Counting, Percentage

Power Supply

120 V AC Adapter, 11 VA

Stabilization Time (typical)

AD-4212A-100, AD-4212B-102:
0-30 g approx. 1.3 seconds
30 g-110 g approx. 1.3 seconds

I/O Interface Comparator Output

3 level output with buzzer

I/O Interface External Contact Input

Re-zero and print

Calibration Weight

AD-4212A-100, AD-4212B-102: 50 g

Connection Cable

Approx. 2 m (between weighing unit and display unit)

Operating Temperature

41° F to 104° F (5° C to 40° C) 85% RH or less (no condensation)

Est. Weight

8.5 lb (4 kg)

Warranty

Five-year limited warranty

Return Policy

A&D Weighing Standard Policy - restock fee may apply

Model	Capacity	Readability	Repeatability	Linearity	Pan Size	Dimensions	Part #	List Price
AD-4212A-100	110 g	0.1 mg	0.15 g	±0.3 mg	2 × 2 in (50 × 50 mm)	3.2 × 9.1 × 3.5 in (80 × 230 × 90 mm)	97654	\$5,660.00
AD-4212B-102	110 g	0.01 mg	0.15 g	±0.3 mg	2 × 2 in (50 × 50 mm)	3.2 × 9.1 × 3.5 in (80 × 230 × 90 mm)	102925	\$8,750.00
AD-4212B-201	210 g	0.1 mg	1 mg	±2 mg	2 × 2 in (50 × 50 mm)	3.2 × 9.1 × 3.5 in (80 × 230 × 90 mm)	102926	\$6,695.00
AD-4212B-301	310 g	0.1 mg	1 mg	±2 mg	2 × 2 in (50 × 50 mm)	3.2 × 9.1 × 3.5 in (80 × 230 × 90 mm)	102927	\$7,450.00

Options/Accessories

Part #	A&D Model #	Description	Price
97672	AD-4212A-01	BCD output (factory installed, four month lead time)	\$581.00
97674	AD-4212A-07	Extension cable, 3 m	\$171.00
97675	AD-4212A-08	Ethernet Interface with WinCT [®]	\$299.00
97676	AD-4212A-19	Stainless steel breeze break (200 g only)	\$110.00



ANALYTICAL APOLLO GF Series

Standard Features

- Electronically controlled load (ECL) self-diagnostic before internal repeatability test without an external weight in less than 1.5 minutes
- External calibration
- Impact shock detection
- Flow rate display
- RS-232 interface for connecting to printer or PC
- Password protection and anti-theft security slot
- GLP/GMP/ISO compliant to either AD-8127 printer or computer
- Transmits date, time, ID number, serial number, model, manufacturer and calibration data
- Rechargeable battery option for portability
- Super Hybrid Sensor Technology (SHS)
- Reverse backlit LCD display
- Optional glass breeze break
- Underhook weighing

Specifications

Weighing Units

Gram, Ounce, Pound, Pound/Ounce, Troy Ounce, Grain (See technical manual for complete listing)

Operating Modes

Weigh, Count and Percent

Power

110/220V VAC adapter

Stabilization Time

Approx. 1 second (typical in FAST mode)

Calibration Weight

GF-124A: 100 g
GF-224A: 200 g
GF-324A: 300 g

Operating Temperature

41° F to 104° F (5° C to 40° C)

Est. Weight

11 lb (5.2 kg)

Warranty

Five-year limited warranty

Return Policy

A&D Weighing Standard Policy - restock fee may apply

Model	Capacity	Readability	Repeatability	Linearity	Weighing Chamber	Pan Size	Dimensions	Part #	List Price
GF-124A	120 g	0.0001 g	0.0001 g	±0.0002 g	8.78 in H (223 mm H)	Ø90 mm	259 × 358 × 332 mm (10.2 × 14.1 × 13.1 in) <i>Includes Large Glass Breeze Break</i>	200327	\$2,475.00
GF-224A	220 g	0.0001 g	0.0001 g	±0.0002 g	8.78 in H (223 mm H)	Ø90 mm	259 × 358 × 332 mm (10.2 × 14.1 × 13.1 in) <i>Includes Large Glass Breeze Break</i>	200328	\$2,700.00
GF-324A	320 g	0.0001 g	0.0002 g (300 g) 0.0001 g (200 g)	±0.0003 g	8.78 in H (223 mm H)	Ø90 mm	259 × 358 × 332 mm (10.2 × 14.1 × 13.1 in) <i>Includes Large Glass Breeze Break</i>	200329	\$3,200.00

Options/Accessories

Part #	A&D Model #	Description	Price
192662	GXA-03	RS-232C Interface (D-sub 9P male)	\$235.00
192663	GXA-04	Comparator output (requires 192667)	\$225.00
192667	AX-K05692	MiniDIN 8 pin male for GXA-04	\$45.00
192671	GXA-06	Analog output (includes 192673)	\$225.00
192674	GXA-09	Internal rechargeable battery (must be factory installed)	\$470.00
192675	GXA-10	Large glass breeze break	\$330.00
192676	GXA-12	Animal weighing pan (for models of 320 g capacity or higher)	\$145.00
192677	GXA-13	Density determination kit (for 1 mg models only)	\$515.00
192678	GXA-17	Large breeze break with built-in fanless ionizer (static eliminator)	\$925.00
192679	GXA-23-PRINT	External key input interface for SW:137-PRINT foot switch	\$215.00
192680	GXA-23-RZERO	External key input interface for SW:137-REZERo foot switch	\$210.00
192681	GXA-23-PLUG	External key input interface for AX-T-314A-S plug	\$210.00
192682	GXA-24	USB host interface (USB A type)	\$110.00
192683	GXA-25	External fanless ionizer (static eliminator)	\$830.00
192684	GXA-26	External IR switch (MiniDIN 4 pin male)	\$175.00



Apollo GF-324A

Standard Features

- Electronically controlled load (ECL) self-diagnostic before internal repeatability test without an external weight in less than 1.5 minutes
- Internal calibration weight
- Impact shock detection
- Flow rate display
- RS-232 interface for connecting to printer or PC
- Password protection and anti-theft security slot
- GLP/GMP/ISO compliant to either AD-8127 printer or computer
- Transmits date, time, ID number, serial number, model, manufacturer and calibration data
- Rechargeable battery option for portability
- Super Hybrid Sensor Technology (SHS)
- Reverse backlit LCD display
- Optional glass breeze break
- Underhook weighing

Specifications

Weighing Units

Gram, Ounce, Pound, Carat, Pennyweight, Troy Ounce, Grain (See technical manual for complete listing)

Operating Modes

Animal Weighing, Comparator Function, ACAI Counting Function, Percentage, Density Determination, Statistical Calculation

Power

120 VAC adapter, Approx. 30 VA

Stabilization Time

GX-124A: Approx. 1.5 seconds
 GX-124AE: Approx. 2 seconds
 GX-224A, GX-224AE: Approx. 1 second
 GX-324A, GX-324AE: Approx. 2 seconds

Display Refresh Rate

5 times/second, 10 times/second, 20 times/second

Calibration Weight

GX-124A, GX-124AE: 100g
 GX-224A, GX-224AE, GX-324A, GX-324AE: 200g

Ionizer (fanless)

AE versions come standard with built-in fanless ionizer with external touchless sensor

Operating Temperature

41° F to 104° F (5° C to 40° C) RH less than 85% (no condensation)

Est. Weight

18 lb (8 kg)

Warranty

Five-year limited warranty

Return Policy

A&D Weighing Standard Policy - restock fee may apply

Model	Capacity	Readability	Repeatability	Linearity	Weighing Chamber	Pan Size	Dimensions	Part #	List Price
GX-124A	120 g	0.0001 g	0.0001 g	±0.0002 g	8.78 in H (223 mm H)	Ø90 mm	10.2 × 14.1 × 13.1 in (259 × 358 × 332 mm) <i>Includes Large Glass Breeze Break</i>	200330	\$2,950.00
GX-124AE	120 g	0.0001 g	0.0001 g	±0.0002 g	8.78 in H (223 mm H)	Ø90 mm	259 × 358 × 332 mm (10.2 × 14.1 × 13.1 in) <i>Includes Large Glass Breeze Break</i>	200334	\$4,395.00
GX-224A	220 g	0.0001 g	0.0001 g	±0.0002 g	8.78 in H (223 mm H)	Ø90 mm	259 × 358 × 332 mm (10.2 × 14.1 × 13.1 in) <i>Includes Large Glass Breeze Break</i>	200332	\$3,175.00
GX-224AE	220 g	0.0001 g	0.0001 g	±0.0002 g	8.78 in H (223 mm H)	Ø90 mm	259 × 358 × 332 mm (10.2 × 14.1 × 13.1 in) <i>Includes Large Glass Breeze Break</i>	200335	\$4,585.00
GX-324A	320 g	0.0001 g	0.0002 g (300 g) 0.0001 g (200 g)	±0.0003 g	8.78 in H (223 mm H)	Ø90 mm	259 × 358 × 332 mm (10.2 × 14.1 × 13.1 in) <i>Includes Large Glass Breeze Break</i>	200333	\$3,550.00
GX-324AE	320 g	0.0001 g	0.0002 g (300 g) 0.0001 g (200 g)	±0.0003 g	8.78 in H (223 mm H)	Ø90 mm	259 × 358 × 332 mm (10.2 × 14.1 × 13.1 in) <i>Includes Large Glass Breeze Break</i>	200336	\$4,925.00

Options/Accessories

Part #	A&D Model #	Description	Price
192662	GXA-03	RS-232C Interface (D-sub 9P male)	\$235.00
192663	GXA-04	Comparator output (requires 192667)	\$225.00
192667	AX-K05692	MiniDIN 8 pin male for GXA-04	\$45.00
192671	GXA-06	Analog output (includes 192673)	\$225.00
192674	GXA-09	Internal rechargeable battery (must be factory installed)	\$470.00
192675	GXA-10	Large glass breeze break	\$330.00
192676	GXA-12	Animal weighing pan (for models of 320 g capacity or higher)	\$145.00
192677	GXA-13	Density determination kit (for 1 mg models only)	\$515.00
192679	GXA-23-PRINT	External key input interface for SW:137-PRINT foot switch	\$215.00
192680	GXA-23-RZERO	External key input interface for SW:137-REZERo foot switch	\$210.00
192681	GXA-23-PLUG	External key input interface for AX-T-314A-S plug	\$210.00
192682	GXA-24	USB host interface (USB A type)	\$110.00
192683	GXA-25	External fanless ionizer (static eliminator)	\$830.00
192684	GXA-26	External IR switch (MiniDIN 4 pin male)	\$175.00



LEGAL FOR TRADE

GF-P Series

Standard Features

- Pill-counting feature also complies with Handbook 44 requirements
- Fast, Super Hybrid Sensor (SHS) gives you the ultimate in response speed; just one second
- GLP/GMP/ISO compliance
- WinCT[®] communication tools software included
- Weighing chamber
- Tough die-cast aluminum housing
- Removable stainless steel pan 5 in x 5 in (127 mm x 127 mm)
- NTEP Certified and Pharmacopoeia approved
- IP54 splash proof operator keyboard protects against dust and spills, stainless steel weigh pan
- Data memory function
- Vacuum Fluorescent Display (VFD)
- RS-232 interface for connecting to printer or PC

Specifications

Weighing Units

Gram, Ounce, Pound, Pound/Ounce, Troy Ounce, Grain, Pound/Ounce (See technical manual for complete listing)

Operating Modes

Weigh, Count and Percent

Power

110/220V VAC adapter

Stabilization Time

Approx. 1 second (typical in FAST mode)

Decimal Ounce

GF-200P: 7.40755×0.00005 oz
GF-300P: 10.93493×0.00005 oz

Calibration Weight

GF-200P, GF-300P: 200 g

Operating Temperature

41° F to 104° F (5° C to 40° C)

Est. Weight

11 lb (5.2 kg)

Warranty

Five-year limited warranty

Return Policy

A&D Weighing Standard Policy - restock fee may apply

Approvals

NTEP CC 04-077 e=0.01g



Model	Capacity	Readability	Repeatability	Linearity	Weighing Chamber	Pan Size	Dimensions	Part #	List Price
GF-200P	210 g	0.001 g	0.001 g	±0.002 g	92 mm (3.6 in H)	127 mm (5 × 5 in)	210 × 317 × 86 mm (8.27 × 12.48 × 3.39 in)	97799	\$1,385.00
GF-300P	310 g	0.001 g	0.001 g	±0.002 g	92 mm (3.6 in H)	127 mm (5 × 5 in)	210 × 317 × 86 mm (8.27 × 12.48 × 3.39 in)	97800	\$1,650.00

Options/Accessories

Part#	A&D Model #	Description	Price
102891	GX-02	USB option	\$155.00
97697	GX-10	Glass breeze break for GF-200 and 300	\$284.00
97703	AX:073003691-S	Protective in-use cover for GF-200/300 (each)	\$21.00
97649	TB:648	AC adapter (120 V/220 V) standard with unit	\$45.00



Standard Features

- Compact Super Hybrid Sensor Technology (SHS)
- Vacuum Fluorescent Display (VFD)
- GLP/GMP/ISO compliant to either AD-8121 printer or computer. Transmits date, time, ID number, serial number and calibration data
- RS-232 interface for connecting to printer or PC
- Response indicator function
- Weighing chamber
- Underhook weighing

OPTIONS

- Built-in rechargeable battery
- Quick USB interface (FXi-02) option
- LAN-Ethernet interface
- WinCT[®] communication tools software

Specifications

Weighing Units

Pound, Carat, Pennyweight, Troy Ounce, Grain, Pound/Ounce (See technical manual for complete listings)

Operating Modes

Weigh, Count, Percent, Animal Weighing, Statistical, Hold and Comparator

Power Consumption

120/240 V AC adapter, approx. 11 VA

Stabilization Time

Approx. 1 second

Sensitivity Drift (10° C to 30° C)

±2 ppm/° C (when automatic self-calibration is not used)

Display Refresh Rate

5 times/second, 10 times/second or 20 times/second

Operating Temperature

41° F to 104° F (5° C to 40° C) 85% RH or less (no condensation)

Calibration Weight

FX-300i: 300 g
 FX-1200i: 1,000 g

Est. Weight

8 lb (3.5 kg)

Warranty

Five-year limited warranty

Return Policy

A&D Weighing Standard Policy - restock fee may apply

Approvals

NTEP CC 08-045
 Measurement Canada AM-5692



Model	Capacity	Readability	Repeatability	Linearity	Pan Size	Dimensions	Part #	List Price
NTEP Certified								
FX-1200iN	1,220 g	0.01 g	0.01 g	±0.02 g	5.90 in (150 mm)	7.6 × 10.3 × 3.3 in (193 × 262.5 × 84.5 mm)	163641	\$1,175.00
Measurement Canada Approved								
FX-300iNC	320 g	0.001 g	0.001 g	±0.002 g	130 mm (5.12 in)	7.6 × 10.3 × 3.3 in (193 × 263 × 84.5 mm)	168077	\$1,245.00
FX-1200iNC	1,220 g	0.01 g	0.01 g	±0.02 g	5.90 in (150 mm)	7.6 × 10.3 × 3.3 in (193 × 262.5 × 84.5 mm)	168076	\$1,185.00

Options/Accessories

Part #	A&D Model #	Description	Price
98027*	FXi-02	Quick USB interface	\$91.00
98028*	FXi-08	Ethernet interface with WinCT [®] Plus software	\$299.00
98029*	FXi-09	Built-in rechargeable battery	\$335.00
98030	FXi-10	Small breeze break	\$81.00
98031	FXi-11	Large breeze break	\$135.00
97649	TB:648	AC adapter (120 V/220 V)	\$45.00
151247	AD-1688	Data logger	\$320.00
196128	AD-8127	Impact dot matrix, statistical printer, includes cable	\$890.00

*Options FXi-02/FXi-08 and FXi-09 cannot be combined and are factory installed only.



LEGAL FOR TRADE
EK-i Series

Standard Features

- Backlit weight display
- Remote zeroing
- Easy to install NiCad battery option
- RS-232 interface for connecting to printer or PC

Specifications

Weighing Units

Carat, Pennyweight, Troy Ounce, Newton, Decimal Ounce, Decimal Pound

Operating Modes

Counting, Percentage

Power

120 VAC adapter (Optional Ni-MH battery pack)

Stabilization Time

< 2 seconds

Sensitivity Drift (10° C to 30° C)

±20 ppm/° C (when automatic self-calibration is not used)

Display Type

7 segment LCD with backlight
(character height 16 mm)

Operating Temperature

14° F to 104° F (-10° C to 40° C) less than 85% R.H.
(non-condensing)

Calibration Weight

EK-600i: 400 g
EK-1200i: 1,200 g
EK-6000i: 6,000 g
EK-12i: 12 kg

Est. Weight

3.5 lb (1.5 kg)

Warranty

Five-year limited warranty

Return Policy

A&D Weighing Standard Policy -
restock fee may apply

Approvals

NTEP CC-04-019



Model	Capacity	Readability	Repeatability	Linearity	Pan Size	Dimensions	Part #	List Price
NTEP Certified								
EK-600i	600 g	0.1 g	0.1 g	±0.1 g	133 × 170 mm (5.2 × 6.7 in)	190 × 218 × 55 mm (7.5 × 8.6 × 2.2 in)	97752	\$545.00
EK-1200i	1,200 g	0.1 g	0.1 g	±0.1 g	133 × 170 mm (5.2 × 6.7 in)	190 × 218 × 55 mm (7.5 × 8.6 × 2.2 in)	97753	\$540.00
EK-6000i	6,000 g	1 g	1 g	±1 g	133 × 170 mm (5.2 × 6.7 in)	190 × 218 × 55 mm (7.5 × 8.6 × 2.2 in)	97758	\$580.00
EK-12i	12,000 g	1 g	1 g	±1 g	133 × 170 mm (5.2 × 6.7 in)	190 × 218 × 55 mm (7.5 × 8.6 × 2.2 in)	97759	\$735.00

Options/Accessories

Part #	A&D Model #	Description	Price
97760	EKW-04i	Comparator/relay outputs/buzzer	\$170.00
97761	EKW-07i	Underhook for EK-4100i/6100i/6000i/12Ki/EW-12Ki	\$55.00
97762	EKW-09i	NiCad battery pack	\$220.00
97764	AX:3005824-5S	Protective dust cover (not in use)	\$15.00
97605	AD-100-2	Anti-theft device	\$77.00
97766	TB:662	AC adapter (120 V)	\$44.00
97767	TB:164	AC adapter (240 V)	\$55.00
151247	AD-1688	Data logger	\$320.00



Standard Features

- Backlit weight display
- Remote zeroing
- Easy-to-install NiCad battery option
- RS-232 interface for connecting to printer or PC
- Triple range

Specifications

Weighing Units

Carat, Pennyweight, Troy Ounce, Decimal Ounce, Decimal Pound

Operating Mode

Counting, Percentage, Comparator

Power

AC adapter or Ni-MH battery pack (option)

Stabilization Time

< 2 seconds

Sensitivity Drift (10° C to 30° C)

±20 ppm/° C (when automatic self-calibration is not used)

Operating Temperature

14° F to 104° F (-10° C to 40° C) less than 85% R.H. (non-condensing)

Calibration Weight

EW-1500i: 1,500 g
EW-12Ki: 12 kg

Est. Weight

3.5 lb (1.5 kg)

Warranty

Five-year limited warranty

Return Policy

A&D Weighing Standard Policy - restock fee may apply

Approvals

NTEP CC 04-019



Model	Capacity	Readability	Repeatability	Linearity	Pan Size	Dimensions	Part #	List Price
NTEP Certified								
EW-1500i	300 g / 600 g / 1,500 g	0.1 g / 0.2 g / 0.5 g	0.1 g / 0.2 g / 0.5 g	±0.1 g / ±0.2 g / ±0.5 g	133 × 170 mm (5.2 × 6.7 in)	190 × 218 × 55 mm (7.5 × 8.6 × 2.2 in)	97769	\$435.00
EW-12Ki	3,000 g / 6,000 g / 12,000 g	1 g / 2 g / 5 g	1 g / 2 g / 5 g	±1 g / ±2 g / ±5 g	133 × 170 mm (5.2 × 6.7 in)	190 × 218 × 55 mm (7.5 × 8.6 × 2.2 in)	97771	\$435.00

Options/Accessories

Part #	A&D Model #	Description	Price
97760	EKW-04i	Comparator/relay outputs/buzzer	\$170.00
97761	EKW-07i	Underhook for EK-4100i/6100i/6000i/12Ki/EW-12Ki	\$55.00
97762	EKW-09i	NiCad battery pack	\$220.00
97764	AX:3005824-5S	Protective dust cover (not in use)	\$15.00
97605	AD-100-2	Anti-theft device	\$77.00
97766	TB:662	AC adapter (120 V)	\$44.00
97767	TB:164	AC adapter (240 V)	\$55.00
151247	AD-1688	Data logger	\$320.00



EW-1500i square pan

PRECISION

APOLLO GX Series

Standard Features

- Electronically controlled load (ECL) self-diagnostic before internal repeatability test without an external weight in less than 1.5 minutes
- Internal calibration weight
- Impact shock detection
- Flow rate display
- RS-232 interface for connecting to printer or PC
- Password protection and anti-theft security slot
- GLP/GMP/ISO compliant to either AD-8127 printer or computer
- Transmits date, time, ID number, serial number, model, manufacturer and calibration data
- Rechargeable battery option for portability
- Super Hybrid Sensor Technology (SHS)
- Reverse backlit LCD display
- Optional glass breeze break
- Underhook weighing

Specifications

Weighing Units

Gram, Ounce, Pound, Carat, Pennyweight, Troy Ounce, Grain (See technical manual for complete listing)

Operating Modes

Animal Weighing, Comparator Function, ACAI Counting Function, Percentage, Density Determination, Statistical Calculation

Power

120 VAC adapter, Approx. 30 VA

Stabilization Time

Approx. 1 second

Display Refresh Rate

5 times/second, 10 times/second or 20 times/second

Ionizer (fanless)

AE versions come standard with built-in fanless ionizer with external touchless sensor

Calibration Weight

GX-203A, GX-303A: 200g
GX-403A: 400g
GX-603A: 600g
GX-1003A, GX-1603A: 1000g

Est. Weight

18 lb (8 kg)

Operating Temperature

41° F to 104° F (5° C to 40° C) RH less than 85% (no condensation)

Warranty

Five-year limited warranty

Return Policy

A&D Weighing Standard Policy - restock fee may apply

Model	Capacity	Readability	Repeatability	Linearity	Weighing Chamber	Pan Size	Dimensions	Part #	List Price
GX-203A	220 g	0.001 g	0.001 g	±0.002 g	3 in (85 mm)	5 × 5 in (128 × 128 mm)	8.3 × 12.5 × 3.7 in (212 × 317 × 93 mm)	191691	\$1,675.00
GX-303A	320 g	0.001 g	0.001 g	±0.002 g	3 in (85 mm)	5 × 5 in (128 × 128 mm)	8.3 × 12.5 × 3.7 in (212 × 317 × 93 mm)	191692	\$1,875.00
GX-403A	420 g	0.001 g	0.001 g	±0.002 g	3 in (85 mm)	5 × 5 in (128 × 128 mm)	8.3 × 12.5 × 3.7 in (212 × 317 × 93 mm)	191693	\$1,990.00
GX-603A	620 g	0.001 g	0.001 g	±0.002 g	3 in (85 mm)	5 × 5 in (128 × 128 mm)	8.3 × 12.5 × 3.7 in (212 × 317 × 93 mm)	191694	\$2,595.00
GX-1003A	1,100 g	0.001 g	0.001 g	±0.003 g	3 in (85 mm)	5 × 5 in (128 × 128 mm)	8.3 × 12.5 × 3.7 in (212 × 317 × 93 mm)	191695	\$2,995.00
GX-1603A	1,620 g	0.001g	0.001g	±0.003 g	3 in (85 mm)	5 × 5 in (128 × 128 mm)	8.3 × 12.5 × 3.7 in (212 × 317 × 93 mm)	191696	\$3,405.00

Options/Accessories

Part #	A&D Model #	Description	Price
192662	GXA-03	RS-232C Interface (D-sub 9P male)	\$235.00
192663	GXA-04	Comparator output (requires 192667)	\$225.00
192667	AX-K05692	MiniDIN 8 pin male for GXA-04	\$45.00
192671	GXA-06	Analog output (includes 192673)	\$225.00
192674	GXA-09	Internal rechargeable battery (must be factory installed)	\$470.00
192675	GXA-10	Large glass breeze break	\$330.00
192676	GXA-12	Animal weighing pan (for models of 320 g capacity or higher)	\$145.00
192677	GXA-13	Density determination kit (for 1 mg models only)	\$515.00
192678	GXA-17	Large breeze break with built-in fanless ionizer (static eliminator)	\$925.00
192679	GXA-23-PRINT	External key input interface for SW:137-PRINT foot switch	\$215.00
192680	GXA-23-RZERO	External key input interface for SW:137-REZERo foot switch	\$210.00
192681	GXA-23-PLUG	External key input interface for AX-T-314A-S plug	\$210.00
192682	GXA-24	USB host interface (USB A type)	\$110.00
192683	GXA-25	External fanless ionizer (static eliminator)	\$830.00
192684	GXA-26	External IR switch (MiniDIN 4 pin male)	\$175.00



PRECISION APOLLO GF Series

Standard Features

- Electronically controlled load (ECL) self-diagnostic before internal repeatability test without an external weight in less than 1.5 minutes
- External calibration
- Impact shock detection
- Flow rate display
- RS-232 interface for connecting to printer or PC
- Password protection and anti-theft security slot
- GLP/GMP/ISO compliant to either AD-8127 printer or computer
- Transmits date, time, ID number, serial number, model, manufacturer and calibration data
- Rechargeable battery option for portability
- Super Hybrid Sensor Technology (SHS)
- Reverse backlit LCD display
- Optional glass breeze break
- Underhook weighing

Specifications

Weighing Units

Pound, Carat, Pennyweight, Troy Ounce, Grain, Decimal Ounce, Pound/Ounce

Operating Modes

Counting, Percentage

Power

120/240 V AC adapter

Stabilization Time

Approx. 1.5 seconds (typical in FAST mode)

Display Refresh Rate

5 times/second or 10 times/second

Calibration Weight

GF-203A: 200 g
GF-303A: 300 g
GF-403A: 400 g
GF-603A: 600 g
GF-1003A: 1000 g
GF-1603A: 1500 g

Operating Temperature

41° F to 104° F (5° C to 40° C) RH less than 85% (no condensation)

Est. Weight

18.3 lb (8.3 kg)

Warranty

Five-year limited warranty

Model	Capacity	Readability	Repeatability	Linearity	Weighing Chamber	Pan Size	Dimensions	Part #	List Price
GF-203A	220 g	0.001 g	0.001 g	±0.002 g	3 in H (85 mm H)	128 × 128 mm (5 × 5 in)	212 × 317 × 93 mm (8.3 × 12.5 × 3.7 in)	191707	\$1,375.00
GF-303A	320 g	0.001 g	0.001 g	±0.002 g	3 in H (85 mm H)	128 × 128 mm (5 × 5 in)	212 × 317 × 93 mm (8.3 × 12.5 × 3.7 in)	191708	\$1,550.00
GF-403A	420 g	0.001 g	0.001 g	±0.003 g	3 in H (85 mm H)	128 × 128 mm (5 × 5 in)	212 × 317 × 93 mm (8.3 × 12.5 × 3.7 in)	191709	\$1,675.00
GF-603A	620 g	0.001 g	0.001 g	±0.03 g	3 in H (85 mm H)	128 × 128 mm (5 × 5 in)	212 × 317 × 93 mm (8.3 × 12.5 × 3.7 in)	191710	\$1,975.00
GF-1003A	1,100 g	0.001 g	0.001 g	±0.03 g	3 in H (85 mm H)	128 × 128 mm (5 × 5 in)	212 × 317 × 93 mm (8.3 × 12.5 × 3.7 in)	191711	\$2,375.00
GF-1603A	1,620 g	0.001 g	0.002 g	±0.03 g	3 in H (85 mm H)	128 × 128 mm (5 × 5 in)	212 × 317 × 93 mm (8.3 × 12.5 × 3.7 in)	191712	\$3,055.00

Options/Accessories

Part #	A&D Model #	Description	Price
192662	GXA-03	RS-232C Interface (D-sub 9P male)	\$235.00
192663	GXA-04	Comparator output (requires 192667)	\$225.00
192667	AX-K05692	MiniDIN 8 pin male for GXA-04	\$45.00
192671	GXA-06	Analog output (includes 192673)	\$225.00
192674	GXA-09	Internal rechargeable battery (must be factory installed)	\$470.00
192675	GXA-10	Large glass breeze break	\$330.00
192676	GXA-12	Animal weighing pan (for models of 320 g capacity or higher)	\$145.00
192677	GXA-13	Density determination kit (for 1 mg models only)	\$515.00
192678	GXA-17	Large breeze break with built-in fanless ionizer (static eliminator)	\$925.00
192679	GXA-23-PRINT	External key input interface for SW:137-PRINT foot switch	\$215.00
192680	GXA-23-RZERO	External key input interface for SW:137-REZERo foot switch	\$210.00
192681	GXA-23-PLUG	External key input interface for AX-T-314A-S plug	\$210.00
192682	GXA-24	USB host interface (USB A type)	\$110.00
192683	GXA-25	External fanless ionizer (static eliminator)	\$830.00
192684	GXA-26	External IR switch (MiniDIN 4 pin male)	\$175.00



Apollo GF-1003A

PRECISION FX-iWP Series Washdown

Standard Features

- Washdown IP65 rating
- Compact Super Hybrid Sensor Technology (SHS)
- Vacuum Fluorescent Display (VFD)
- GLP/GMP/ISO compliant to either AD-8121 printer or computer. Transmits date, time, ID number, serial number and calibration data
- RS-232 interface for connecting to printer or PC
- Response indicator function
- Underhook weighing

Specifications

Weighing Units

Pound, Carat, Pennyweight, Troy Ounce, Grain, Pound/Ounce

Operating Modes

Weigh, Count, Percent, Animal Weighing, Statistical, Hold and Comparator

Power

120/240 VAC adapter, approx. 11 VA

Stabilization Time

Approx. 1 second

Sensitivity Drift (10° C to 30° C)

±2 ppm/° C

Display Refresh Rate

5 times/second, 10 times/second or 20 times/second

Calibration Weight

FX-120iWP: 100 g

FX-200iWP: 200 g

FX-300iWP: 300g

Operating Temperature

41° F to 104° F (5° C to 40° C) 85% RH or less (no condensation)

Est. Weight

8 lb (3.5 kg)

Warranty

Five-year limited warranty

Return Policy

A&D Weighing Standard Policy - restock fee may apply

Model	Capacity	Readability	Repeatability	Linearity	Pan Size	Dimensions	Part #	List Price
FX-120iWP	122 g	0.001 g	0.001 g	±0.002 g	Ø 5.12 in (130 mm)	6 × 10.3 × 3.3 in (193 × 263 × 85 mm)	102905	\$1,525.00
FX-200iWP	220 g	0.001 g	0.001 g	±0.002 g	Ø 5.12 in (130 mm)	6 × 10.3 × 3.3 in (193 × 263 × 85 mm)	102906	\$1,605.00
FX-300iWP	320 g	0.001 g	0.001 g	±0.002 g	Ø 5.12 in (130 mm)	6 × 10.3 × 3.3 in (193 × 263 × 85 mm)	102907	\$1,710.00

Options/Accessories

Part #	A&D Model #	Description	Price
98027*	FXi-02	Quick USB interface	\$91.00
98028*	FXi-08	Ethernet interface with WinCT [®] Plus software	\$299.00
98029*	FXi-09	Built-in rechargeable battery	\$335.00
98030	FXi-10	Small breeze break	\$81.00
98031	FXi-11	Large breeze break	\$135.00
97649	TB:648	AC adapter (120 V/220 V)	\$45.00

*Options FXi-02/FXi-08 and FXi-09 cannot be combined and are factory installed only.



Standard Features

- Compact Super Hybrid Sensor Technology (SHS)
- Vacuum Fluorescent Display (VFD)
- GLP/GMP/ISO compliant to either AD-8121 printer or computer. Transmits date, time, ID number, serial number and calibration data
- RS-232 interface for connecting to printer or PC
- Response indicator function
- Weighing chamber
- Underhook weighing

OPTIONS:

- Built-in rechargeable battery
 - Quick USB interface (FXi-02) option
 - LAN-Ethernet interface
 - WinCT[®] communication tools software
- Note: FXi NTEP and FXi models available by special order (internal calibration)*

Specifications

Weighing Units

Pound, Carat, Pennyweight, Troy Ounce, Grain, Pound/Ounce (See technical manual for complete listings)

Operating Modes

Weigh, Count, Percent, Animal Weighing, Statistical, Hold and Comparator

Power Consumption

120/240 V AC adapter, approx. 11 VA

Stabilization Time

Approx. 1 second

Sensitivity Drift (10° C to 30° C)

±2 ppm/° C

Display Refresh Rate

5 times/second, 10 times/second or 20 times/second

Calibration Weight

FX-120i: 100 g
FX-200i: 200 g
FX-300i: 300 g

Operating Temperature

41° F to 104° F (5° C to 40° C) 85% RH or less (no condensation)

Est. Weight

8 lb (3.5 kg)

Warranty

Five-year limited warranty

Return Policy

A&D Weighing Standard Policy - restock fee may apply

Model	Capacity	Readability	Repeatability	Linearity	Pan Size	Dimensions	Part #	List Price
FX-120i	122 g	0.001 g	0.001 g	±0.002 g	130 mm (5.12 in)	7.6 × 10.3 × 3.3 in (193 × 263 × 84.5 mm)	98021	\$1,085.00
FX-200i	220 g	0.001 g	0.001 g	±0.002 g	130 mm (5.12 in)	7.6 × 10.3 × 3.3 in (193 × 263 × 84.5 mm)	98022	\$1,145.00
FX-300i	320 g	0.001 g	0.001 g	±0.002 g	130 mm (5.12 in)	7.6 × 10.3 × 3.3 in (193 × 263 × 84.5 mm)	98023	\$1,195.00

Options/Accessories

Part #	A&D Model #	Description	Price
98027*	FXi-02	Quick USB interface	\$91.00
98028*	FXi-08	Ethernet interface with WinCT [®] Plus software	\$299.00
98029*	FXi-09	Built-in rechargeable battery	\$335.00
98030	FXi-10	Small breeze break	\$81.00
98031	FXi-11	Large breeze break	\$135.00
97649	TB-648	AC adapter (120 V/220 V)	\$45.00
151247	AD-1688	Data logger	\$320.00
196128	AD-8127	Impact dot matrix, statistical printer, includes cable	\$890.00

*Options FXi-02/FXi-08 and FXi-09 cannot be combined and are factory installed only.



PRECISION

AD-4212A Series

Standard Features

- Comparator output (Hi/OK/Lo) feature for manual or automatic operation as well as buzzer function
- GLP/GMP compliant software output
- Breeze break for maximum accuracy and fastest response
- Standard calibration weight
- Simple operator reference card provided
- Multi-weighing units
- Time and date clock function
- Data memory function for weighing, calibration, counting and Hi/OK/Lo values
- Super Hybrid Sensor Technology (SHS)
- WinCT[®] communication tools software
- RS-232 interface for connecting to printer or PC

Specifications

Weighing Units

Milligram, Ounce, Carat, Pennyweight, Troy Ounce, Grain (See technical manual for complete listings)

Operating Modes

Counting, Percentage

Power Supply

120 V AC Adapter, 11 VA

Stabilization Time (typical)

AD-4212A-200, AD-4212B-201: 30 g- 210 g

Approx. 1.0 second

AD-4212B-301: 30 g-210 g Approx. 1.0 second

AD-4212A-600: 30-610 g Approx. 1.1 seconds

AD-4212A-1000: 30-1100 g Approx. 1.1 seconds

I/O Interface Comparator Output

3 level output with buzzer

I/O Interface External Contact Input

Re-zero and print

Calibration Weight (OIML F1) (OPT)

AD-4212A-200, AD-4212B-201, AD-4212B-301: 100 g
AD-4212A-600, AD-4212A-1000: 200 g

Connection Cable

Approx. 2 m (between weighing unit and display unit)

Operating Temperature

41° F to 104° F (5° C to 40° C) 85% RH or less (no condensation)

Est. Weight

8.5lb (4 kg)

Warranty

Five-year limited warranty

Return Policy

A&D Weighing Standard Policy - restock fee may apply

Model	Capacity	Readability	Repeatability	Linearity	Pan Size	Dimensions	Part #	List Price
AD-4212A-200	210 g	1 mg	1 mg	±2 mg	2 × 2 in (50 × 50 mm)	3.2 × 9.1 × 3.5 in (80 × 230 × 90 mm)	97655	\$4,975.00
AD-4212A-600	610 g	1 mg	1 mg	±3 mg	2.8 × 2.8 in (70 × 70 mm)	3.2 × 9.1 × 3.5 in (80 × 230 × 90 mm)	97656	\$5,495.00
AD-4212A-1000	1,100 g	1 mg	1 mg	±3 mg	2.8 × 2.8 in (70 × 70 mm)	3.2 × 9.1 × 3.5 in (80 × 230 × 90 mm)	97657	\$5,695.00

Options/Accessories

Part #	A&D Model #	Description	Price
97672	AD-4212A-01	BCD output (factory installed, four month lead time)	\$581.00
97674	AD-4212A-07	Extension cable, 3 m	\$171.00
97675	AD-4212A-08	Ethernet Interface with WinCT [®]	\$299.00
97676	AD-4212A-19	Stainless steel breeze break (200 g only)	\$110.00



Standard Features

- Compact Super Hybrid Sensor Technology (SHS)
- Vacuum Fluorescent Display (VFD)
- GLP/GMP/ISO compliant to either AD-8121 printer or computer. Transmits date, time, ID number, serial number and calibration data
- RS-232 interface for connecting to printer or PC
- Response indicator function
- Weighing chamber
- Underhook weighing

OPTIONS

- Built-in rechargeable battery
- Quick USB interface (FXi-02) option
- LAN-Ethernet interface
- WinCT[®] communication tools software

Specifications

Weighing Units

Pound, Carat, Pennyweight, Troy Ounce, Grain, Pound/Ounce, (See technical manual for complete listings)

Operating Modes

Weigh, Count, Percent, Animal Weighing, Statistical, Hold and Comparator

Power Consumption

120/240 V AC adapter, approx. 11 VA

Stabilization Time

Approx. 1 second

Sensitivity Drift (10° C to 30° C)

±2 ppm/° C

Display Refresh Rate

5 times/second, 10 times/second or 20 times/second

Calibration Weight

FX-1200i: 1,000 g
FX-2000i: 2,000 g
FX-3000i: 3,000g

Operating Temperature

41° F to 104° F (5° C to 40° C) 85% RH or less (no condensation)

Est. Weight

8 lb (3.5 kg)

Warranty

Five-year limited warranty

Return Policy

A&D Weighing Standard Policy - restock fee may apply

Model	Capacity	Readability	Repeatability	Linearity	Pan Size	Dimensions	Part #	List Price
FX-1200i	1,220 g	0.01 g	0.01 g	±0.02 g	5.90 in (150 mm)	7.6 × 10.3 × 3.3 in (193 × 262.5 × 84.5 mm)	98024	\$1,125.00
FX-2000i	2,200 g	0.01 g	0.01 g	±0.02 g	5.90 in (150 mm)	7.6 × 10.3 × 3.3 in (193 × 262.5 × 84.5 mm)	98025	\$1,185.00
FX-3000i	3,200 g	0.01 g	0.01 g	±0.02 g	5.90 in (150 mm)	7.6 × 10.3 × 3.3 in (193 × 262.5 × 84.5 mm)	98026	\$1,235.00

Options/Accessories

Part#	A&D Model#	Description	Price
98027*	FXi-02	Quick USB interface	\$91.00
98028*	FXi-08	Ethernet interface with WinCT [®] Plus software	\$299.00
98029*	FXi-09	Built-in rechargeable battery	\$335.00
98030	FXi-10	Small breeze break	\$81.00
98031	FXi-11	Large breeze break	\$135.00
97649	TB:648	AC adapter (120 V/220 V)	\$45.00
151247	AD-1688	Data logger	\$320.00
196128	AD-8127	Impact dot matrix, statistical printer, includes cable	\$890.00

*Options FXi-02/FXi-08 and FXi-09 cannot be combined and are factory installed only.



TOPLOADER

APOLLO GX Series

Standard Features

- Electronically controlled load (ECL) self-diagnostic before internal repeatability test without an external weight in less than 1.5 minutes
- Internal calibration weight
- Impact shock detection
- Flow rate display
- RS-232 interface for connecting to printer or PC
- Password protection and anti-theft security slot
- GLP/GMP/ISO compliant to either AD-8127 printer or computer
- Transmits date, time, ID number, serial number, model, manufacturer and calibration data
- Rechargeable battery option for portability
- Super Hybrid Sensor Technology (SHS)
- Reverse backlit LCD display
- Optional glass breeze break
- Underhook weighing

Specifications

Weighing Units

Gram, Ounce, Pound, Carat, Pennyweight, Troy Ounce, Grain (See technical manual for complete listing)

Operating Modes

Animal Weighing, Comparator Function, ACAI Counting Function, Percentage, Density Determination, Statistical Calculation

Power

120 VAC adapter, Approx. 30 VA

Stabilization Time

Approx. 1 sec.

Display Refresh Rate

5 times/second, 10 times/second or 20 times/second

Calibration Weight

GX-2002A, GX-3002A: 2,000 g
GX-4002A: 4000 g
GX-6001A, GX-6002A: 5,000 g
GX-10001A, GX-10002A: 10,000 g

Est. Weight

18 lb (8 kg)

Operating Temperature

41° F to 104° F (5° C to 40° C) RH less than 85% (no condensation)

Warranty

Five-year limited warranty

Return Policy

A&D Weighing Standard Policy - restock fee may apply

Model	Capacity	Readability	Repeatability	Linearity	Pan Size	Dimensions	Part #	List Price
GX-2002A	2,200 g	0.01 g	0.01 g	±0.02 g	5 × 5 in (128 × 128 mm)	8.3 × 12.5 × 3.7 in (212 × 317 × 93 mm)	191697	\$1,950.00
GX-3002A	3,200 g	0.01 g	0.01 g	±0.02 g	5 × 5 in (128 × 128 mm)	8.3 × 12.5 × 3.7 in (212 × 317 × 93 mm)	191700	\$2,230.00
GX-4002A	4,200 g	0.01 g	0.01 g	±0.02 g	5 × 5 in (128 × 128 mm)	8.3 × 12.5 × 3.7 in (212 × 317 × 93 mm)	191701	\$2,335.00
GX-6001A	6,200 g	0.1 g	0.1 g	±0.01 g	5 × 5 in (128 × 128 mm)	8.3 × 12.5 × 3.7 in (212 × 317 × 93 mm)	191705	\$2,075.00
GX-6002A	6,200 g	0.01 g	0.01 g	±0.03 g	5 × 5 in (128 × 128 mm)	8.3 × 12.5 × 3.7 in (212 × 317 × 93 mm)	191702	\$2,735.00
GX-10001A	10,200 g	0.1 g	0.1 g	±0.01 g	5 × 5 in (128 × 128 mm)	8.3 × 12.5 × 3.7 in (212 × 317 × 93 mm)	191706	\$3,055.00
GX-10002A	10,200 g	0.01 g	0.02 g	±0.03 g	5 × 5 in (128 × 128 mm)	8.3 × 12.5 × 3.7 in (212 × 317 × 93 mm)	191704	\$3,675.00

Options/Accessories

Part#	A&D Model #	Description	Price
192662	GXA-03	RS-232C Interface (D-sub 9P male)	\$235.00
192663	GXA-04	Comparator output (requires 192667)	\$225.00
192667	AX-K05692	MiniDIN 8 pin male for GXA-04	\$45.00
192671	GXA-06	Analog output (includes 192673)	\$225.00
192674	GXA-09	Internal rechargeable battery (must be factory installed)	\$470.00
192676	GXA-12	Animal weighing pan (for models of 320 g capacity or higher)	\$145.00
192677	GXA-13	Density determination kit (for 1 mg models only)	\$515.00
192678	GXA-17	Large breeze break with built-in fanless ionizer (static eliminator)	\$925.00
192679	GXA-23-PRINT	External key input interface for SW:137-PRINT foot switch	\$215.00
192680	GXA-23-RZERO	External key input interface for SW:137-REZERo foot switch	\$210.00
192681	GXA-23-PLUG	External key input interface for AX-T-314A-S plug	\$210.00
192682	GXA-24	USB host interface (USB A type)	\$110.00
192683	GXA-25	External fanless ionizer (static eliminator)	\$830.00
192684	GXA-26	External IR switch (MiniDIN 4 pin male)	\$175.00



Apollo GX-3002A

TOPLOADER APOLLO GF Series

Standard Features

- Electronically controlled load (ECL) self-diagnostic before internal repeatability test without an external weight in less than 1.5 minutes
- External calibration
- Impact shock detection
- Flow rate display
- RS-232 interface for connecting to printer or PC
- Password protection and anti-theft security slot
- GLP/GMP/ISO compliant to either AD-8127 printer or computer
- Transmits date, time, ID number, serial number, model, manufacturer and calibration data
- Rechargeable battery option for portability
- Super Hybrid Sensor Technology (SHS)
- Reverse backlit LCD display
- Optional glass breeze break
- Underhook weighing

Specifications

Weighing Units

Pound, Carat, Pennyweight, Troy Ounce, Grain, Decimal Ounce, Pound/Ounce

Operating Modes

Counting, Percentage

Power

120/240 V AC adapter

Stabilization Time

Approx. 1.5 seconds (typical in FAST mode)

Display Refresh Rate

5 times/second or 10 times/second

Calibration Weight

GF-1202A: 1 kg
GF-2002A: 2 kg
GF-3002A: 3 kg
GF-4002A: 4 kg
GF-6002A: 6 kg
GF-6001A: 6 kg
GF-10001A: 10 kg
GF-10002A: 10 kg

Operating Temperature

41° F to 104° F (5° C to 40° C) RH less than 85% (no condensation)

Est. Weight

18.3 lb (8.3 kg)

Warranty

Five-year limited warranty

Model	Capacity	Readability	Repeatability	Linearity	Pan Size	Dimensions	Part #	List Price
GF-1202A	1,220 g	0.01 g	0.01 g	±0.02 g	165 × 165 mm (6.5 × 6.5 in)	212 × 317 × 93 mm (8.3 × 12.5 × 3.7 in)	191713	\$1,385.00
GF-2002A	2,200 g	0.01 g	0.01 g	±0.02 g	128 × 128 mm (5 × 5 in)	212 × 317 × 93 mm (8.3 × 12.5 × 3.7 in)	191714	\$1,425.00
GF-3002A	3,200 g	0.01 g	0.01 g	±0.02 g	128 × 128 mm (5 × 5 in)	212 × 317 × 93 mm (8.3 × 12.5 × 3.7 in)	191715	\$1,475.00
GF-4002A	4,200 g	0.01 g	0.01 g	±0.02 g	128 × 128 mm (5 × 5 in)	212 × 317 × 93 mm (8.3 × 12.5 × 3.7 in)	191716	\$1,890.00
GF-6002A	6,200 g	0.01 g	0.01 g	±0.03 g	128 × 128 mm (5 × 5 in)	212 × 317 × 93 mm (8.3 × 12.5 × 3.7 in)	191717	\$2,310.00
GF-6001A	6,200 g	0.1 g	0.1 g	±0.1 g	128 × 128 mm (5 × 5 in)	212 × 317 × 93 mm (8.3 × 12.5 × 3.7 in)	192486	\$1,575.00
GF-10001A	10,200 g	0.1 g	0.1 g	±0.1 g	128 × 128 mm (5 × 5 in)	212 × 317 × 93 mm (8.3 × 12.5 × 3.7 in)	192487	\$1,645.00
GF-10002A	10,200 g	0.01 g	0.1 g	±0.03 g	165 × 165 mm (6.5 × 6.5 in)	212 × 317 × 93 mm (8.3 × 12.5 × 3.7 in)	191718	\$2,850.00

Options/Accessories

Part #	A&D Model #	Description	Price
192662	GXA-03	RS-232C Interface (D-sub 9P male)	\$235.00
192663	GXA-04	Comparator output (requires 192667)	\$225.00
192667	AX-K05692	MiniDIN 8 pin male for GXA-04	\$45.00
192671	GXA-06	Analog output (includes 192673)	\$225.00
192674	GXA-09	Internal rechargeable battery (must be factory installed)	\$470.00
192675	GXA-10	Large glass breeze break	\$330.00
192676	GXA-12	Animal weighing pan (for models of 320 g capacity or higher)	\$145.00
192677	GXA-13	Density determination kit (for 1 mg models only)	\$515.00
192678	GXA-17	Large breeze break with built-in fanless ionizer (static eliminator)	\$925.00
192679	GXA-23-PRINT	External key input interface for SW:137-PRINT foot switch	\$215.00
192680	GXA-23-RZERO	External key input interface for SW:137-REZERo foot switch	\$210.00
192681	GXA-23-PLUG	External key input interface for AX-T-314A-S plug	\$210.00
192682	GXA-24	USB host interface (USB A type)	\$110.00
192683	GXA-25	External fanless ionizer (static eliminator)	\$830.00
192684	GXA-26	External IR switch (MiniDIN 4 pin male)	\$175.00



Apollo GF-3002A

TOPLOADER FX-iWP Series Washdown

Standard Features

- Washdown IP65 rating
- Compact Super Hybrid Sensor Technology (SHS)
- Vacuum Fluorescent Display (VFD)
- GLP/GMP/ISO compliant to either AD-8121 printer or computer. Transmits date, time, ID number, serial number and calibration data
- RS-232 interface for connecting to printer or PC
- Response indicator function
- Underhook weighing

Specifications

Weighing Units

Pound, Carat, Pennyweight, Troy Ounce, Grain, Pound/Ounce

Operating Modes

Weigh, Count, Percent, Animal Weighing, Statistical, Hold and Comparator

Power

120/240 VAC adapter, approx. 11 VA

Stabilization Time

Approx. 1 second

Sensitivity Drift (10° C to 30° C)

±2 ppm/° C

Display Refresh Rate

5 times/second, 10 times/second or 20 times/second

Calibration Weight

FX1200iWP: 1,000 g
FX-2000iWP: 2,000 g
FX-3000iWP: 3,000 g

Operating Temperature

41° F to 104° F (5° C to 40° C) 85% RH or less (no condensation)

Est. Weight

8 lb (3.5 kg)

Warranty

Five-year limited warranty

Return Policy

A&D Weighing Standard Policy - restock fee may apply

Model	Capacity	Readability	Repeatability	Linearity	Pan Size	Dimensions	Part #	List Price
FX-1200iWP	1,220 g	0.01 g	0.01 g	±0.02 g	Ø 5.90 in (150 mm)	6 × 10.3 × 3.3 in (193 × 263 × 85 mm)	102908	\$1,515.00
FX-2000iWP	2,200 g	0.01 g	0.01 g	±0.02 g	Ø 5.90 in (150 mm)	6 × 10.3 × 3.3 in (193 × 263 × 85 mm)	102909	\$1,605.00
FX-3000iWP	3,200 g	0.01 g	0.01 g	±0.02 g	Ø 5.90 in (150 mm)	6 × 10.3 × 3.3 in (193 × 263 × 85 mm)	102910	\$1,705.00

Options/Accessories

Part #	A&D Model #	Description	Price
98027*	FXi-02	Quick USB interface	\$91.00
98028*	FXi-08	Ethernet interface with WinCT [®] Plus software	\$299.00
98029*	FXi-09	Built-in rechargeable battery	\$335.00
98030	FXi-10	Small breeze break	\$81.00
98031	FXi-11	Large breeze break	\$135.00
97649	TB:648	AC adapter (120 V/220 V)	\$45.00

*Options FXi-02/FXi-08 and FXi-09 cannot be combined and are factory installed only.



TOPLOADER EJ NEWTON Series

Standard Features

- Easy-to-read seven segment LCD display with backlight
- 10 units of measurement
- Battery operated (Four AA not included)
- Selectable modes: weight, count, percentage and specific gravity
- 120 VAC adaptor included (230VAC optional)



EJ-200

Specifications

Weighing Units

Carat, Pennyweight, Troy Ounce, Decimal Ounce, Decimal Pound (See technical manual for complete listing)

Operating Modes

Specific Gravity, Counting, Percentage, Checkweighing

Power

120 VAC adapter
Four AA size dry-cell batteries (not included) 70 hours operation

Stabilization Time

< 2 seconds

Sensitivity Drift (10° C to 30° C)

±20 ppm/° C

Display Type

7 segment LCD with backlight
(character height 16 mm)

Operating Temperature

14° F to 104° F (-10° C to 40° C) less than 85% R.H.
(no condensation)

Calibration Weight

EJ-123, EJ-120: 100 g
EJ-200: 200 g
EJ-300: 300 g
EJ-410: 400 g
EJ-610: 600 g
EJ-1500: 1,500 g
EJ-2000: 2,000 g
EJ-3000: 3,000 g
EJ-4100: 4,000 g
EJ-6100: 6,000 g

Est. Weight

EJ-123, EJ-120, EJ-200, EJ-300, EJ-410, EJ-610: 850 g
EJ-1500, EJ-2000, EJ-3000, EJ-4100, EJ-6100: 1,100g

Warranty

Five-year limited warranty

Return Policy

A&D Weighing Standard Policy - restock fee may apply

Model	Capacity	Readability	Repeatability	Linearity	Pan Size	Dimensions	Part #	List Price
EJ-123	120 g	0.001 g	0.003 g	0.003 g	Ø 4.3 in (110 mm)	7.5 × 8.6 × 2.2 in (190 × 218 × 55 mm)	163274	\$545.00
EJ-120	120 g	0.01 g	0.01 g	±0.01 g	Ø 4.3 in (110 mm)	7.5 × 8.6 × 2.2 in (190 × 218 × 55 mm)	112410	\$280.00
EJ-200	210 g	0.01 g	0.01 g	±0.01 g	Ø 4.3 in (110 mm)	7.5 × 8.6 × 2.2 in (190 × 218 × 55 mm)	112411	\$350.00
EJ-300	310 g	0.01 g	0.01 g	±0.02 g	Ø 4.3 in (110 mm)	7.5 × 8.6 × 2.2 in (190 × 218 × 55 mm)	112412	\$405.00
EJ-410	410 g	0.01 g	0.01 g	±0.02 g	Ø 4.3 in (110 mm)	7.5 × 8.6 × 2.2 in (190 × 218 × 55 mm)	112413	\$445.00
EJ-610	610 g	0.01 g	0.01 g	±0.02 g	Ø 4.3 in (110 mm)	7.5 × 8.6 × 2.2 in (190 × 218 × 55 mm)	112414	\$575.00
EJ-1500	1,500 g	0.1 g	0.1 g	±0.1 g	5 × 5.5 in (127 × 140 mm)	7.5 × 8.6 × 2.2 in (190 × 218 × 55 mm)	112415	\$281.00
EJ-2000	2,100 g	0.1 g	0.1 g	±0.1 g	5 × 5.5 in (127 × 140 mm)	7.5 × 8.6 × 2.2 in (190 × 218 × 55 mm)	112416	\$340.00
EJ-3000	3,100 g	0.1 g	0.1 g	±0.2 g	5 × 5.5 in (127 × 140 mm)	7.5 × 8.6 × 2.2 in (190 × 218 × 55 mm)	112417	\$410.00
EJ-4100	4,100 g	0.1 g	0.1 g	±0.2 g	5 × 5.5 in (127 × 140 mm)	7.5 × 8.6 × 2.2 in (190 × 218 × 55 mm)	112418	\$475.00
EJ-6100	6100 g	0.1 g	0.1 g	±0.2 g	5 × 5.5 in (127 × 140 mm)	7.5 × 8.6 × 2.2 in (190 × 218 × 55 mm)	112419	\$530.00

Options/Accessories

Part#	A&D Model #	Description	Price
112426	EJ-02	USB interface with cable	\$89.00
112427	EJ-03	RS-232 interface with cable	\$79.00
112428	EJ-07	Underhook for EJ-3000, EJ-4100 and EJ-6100	\$71.00
112429	EJ-08	Underhook for EJ-1500 and EJ-2000	\$71.00
112430	EJ-11	Breeze break	\$71.00
112431	EJ-12	Carrying case	\$71.00
112432	EJ-13	Density determination kit	\$81.00
97766	TB:662	AC adapter, 120 V	\$44.00
97767	TB:164	AC adapter, 220 V	\$55.00
151247	AD-1688	Data logger	\$320.00



EJ-2000

TOPLOADER EK-i Series

Standard Features

- Backlit weight display
- Remote zeroing
- Easy to install NiCad battery option
- RS-232 interface for connecting to printer or PC

Specifications

Weighing Units

Carat, Pennyweight, Troy Ounce, Newton, Decimal Ounce, Decimal Pound

Operating Modes

Counting, Percentage

Power

120 VAC adapter (Optional Ni-MH battery pack)

Stabilization Time

< 2 seconds

Sensitivity Drift (10° C to 30° C)

±20 ppm/° C

Display Type

7 segment LCD with backlight
(character height 16 mm)

Operating Temperature

14° F to 104° F (-10° C to 40° C) less than 85% R.H.
(no condensation)

Calibration Weight

EK-120i: 120 g
EK-200i: 200 g
EK-300i: 300 g
EK-410i: 400 g
EK-610i: 400 g
EK-2000i: 2,000 g
EK-3000i: 3,000 g
EK-4100i: 4,000 g
EK-6100i: 6,000 g

Est. Weight

3.5 lb (1.5 kg)

Warranty

Five-year limited warranty

Return Policy

A&D Weighing Standard Policy -
restock fee may apply

Model	Capacity	Readability	Repeatability	Linearity	Pan Size	Dimensions	Part #	List Price
EK-120i	120 g	0.01 g	0.01 g	±0.01 g	110 mm (Ø 4.3 in)	190 × 218 × 55 mm (7.5 × 8.6 × 2.2 in)	97747	\$525.00
EK-200i	200 g	0.01 g	0.01 g	±0.01 g	110 mm (Ø 4.3 in)	190 × 218 × 55 mm (7.5 × 8.6 × 2.2 in)	97748	\$560.00
EK-300i	300 g	0.01 g	0.01 g	±0.02 g	110 mm (Ø 4.3 in)	190 × 218 × 55 mm (7.5 × 8.6 × 2.2 in)	97749	\$580.00
EK-410i	400 g	0.01 g	0.01 g	±0.02 g	110 mm (Ø 4.3 in)	190 × 218 × 55 mm (7.5 × 8.6 × 2.2 in)	97750	\$655.00
EK-610i	600 g	0.01 g	0.01 g	±0.02 g	110 mm (Ø 4.3 in)	190 × 218 × 55 mm (7.5 × 8.6 × 2.2 in)	97751	\$770.00
EK-2000i	2,000 g	0.1 g	0.1 g	±0.1 g	133 × 170 mm (5.2 × 6.7 in)	190 × 218 × 55 mm (7.5 × 8.6 × 2.2 in)	97754	\$565.00
EK-3000i	3,000 g	0.1 g	0.1 g	±0.2 g	133 × 170 mm (5.2 × 6.7 in)	190 × 218 × 55 mm (7.5 × 8.6 × 2.2 in)	97755	\$615.00
EK-4100i	4,000 g	0.1 g	0.1 g	±0.2 g	133 × 170 mm (5.2 × 6.7 in)	190 × 218 × 55 mm (7.5 × 8.6 × 2.2 in)	97756	\$730.00
EK-6100i	6,000 g	0.1 g	0.1 g	±0.2 g	133 × 170 mm (5.2 × 6.7 in)	190 × 218 × 55 mm (7.5 × 8.6 × 2.2 in)	97757	\$910.00

Options/Accessories

Part #	A&D Model #	Description	Price
97760	EKW-04i	Comparator/relay outputs/buzzer	\$170.00
97761	EKW-07i	Underhook for EK-4100i/6100i/6000i/12Ki/EW-12Ki	\$55.00
97762	EKW-09i	NiCad battery pack	\$220.00
97764	AX:3005824-5S	Protective dust cover (not in use)	\$15.00
97605	AD-100-2	Anti-theft device	\$77.00
97766	TB:662	AC adapter (120 V)	\$44.00
97767	TB:164	AC adapter (240 V)	\$55.00
151247	AD-1688	Data logger	\$320.00



Standard Features

- Backlit weight display
- Remote zeroing
- Easy-to-install NiCad battery option
- RS-232 in terface for connecting to printer or PC
- Triple range

Specifications

Weighing Units

Carat, Pennyweight, Troy Ounce, Decimal Ounce, Decimal Pound

Operating Mode

Counting, Percentage, Comparator

Power

AC adapter or Ni-MH battery pack (option)

Stabilization Time

< 2 seconds

Sensitivity Drift (10° C to 30° C)

±20 ppm/° C

Operating Temperature

14° F to 104° F (-10° C to 40° C) less than 85% R.H. (no condensation)

Calibration Weight

EW-150i: 150 g

Est. Weight

3.5 lb (1.5 kg)

Warranty

Five-year limited warranty

Return Policy

A&D Weighing Standard Policy - restock fee may apply

Model	Capacity	Readability	Repeatability	Linearity	Pan Size	Dimensions	Part #	List Price
EW-150i	30 g / 60 g / 150 g	0.01 g / 0.02 g / 0.1 g	0.01 g / 0.02 g / 0.05 g	±0.01 g / ±0.02 g / ±0.05 g	Ø 4.3 in (110 mm)	190 × 218 × 55 mm (7.5 × 8.6 × 2.2 in)	97768	\$435.00

Options/Accessories

Part #	A&D Model #	Description	Price
97760	EKW-04i	Comparator/relay outputs/buzzer	\$170.00
97761	EKW-07i	Underhook for EK-4100i/6100i/6000i/12Ki/EW-12Ki	\$55.00
97762	EKW-09i	NiCad battery pack	\$220.00
97764	AX:3005824-5S	Protective dust cover (not in use)	\$15.00
97605	AD-100-2	Anti-theft device	\$77.00
97766	TB:662	AC adapter (120 V)	\$44.00
97767	TB:164	AC adapter (240 V)	\$55.00
151247	AD-1688	Data logger	\$320.00



HIGH CAPACITY GX-M Series

Standard Features

- Internal calibration
- Auto environmental compensation
- IP65/NEMA Type 4
- RS-232 interface for connecting to printer or PC
- Data memory function
- Quick reference operation card
- Time and date
- Vacuum Fluorescent Display (VFD)
- Underhook weighing

Specifications

Weighing Units

Pound, Carat, Pennyweight, Troy Ounce, Grain, Decimal Ounce, Pound/Ounce

Operating Modes

Counting, Percentage

Power

120 /240 V AC adapter

Stabilization time

Approx. 1.5 seconds

Sensitivity Drift (10° C to 30° C / 50° F to 86° F)

GX-8202M: ±2 ppm/°C
 GX-8202MD: ±3 ppm/°C
 GX-10202M: ±2 ppm/°C
 GX-12001M, GX-22001M, GX-32001M: ±3 ppm/°C
 GX-32001MD: ±5 ppm/°C

Calibration Weight

GX-8202M/MD: 2kg to 8kg
 GX-10202M: 2kg to 10kg
 GX-12001M: 5kg, 10kg
 GX-22001M: 5kg, 10kg, 20kg
 GX-32001M/MD: 5kg, 10kg, 20kg, 30kg

Operating Temperature

41° F to 104° F (-5° C to 40° C)

Est. Weight

18.3 lb (8.3 kg)

Warranty

Five-year limited warranty

Return Policy

A&D Weighing Standard Policy - restock fee may apply

Model	Capacity	Readability	Repeatability	Linearity	Pan Size	Dimensions	Part #	List Price
GX-8202M	8.2 kg	0.01 g	0.01 g	±0.03 g	10.62 × 8.26 in (270 × 210 mm)	11.81 × 13.98 × 4.37 in (300 × 355 × 111 mm)	207408	\$3,715.00
GX-8202MD	2.2 kg / 8.2 kg	0.01 g / 0.1 g	0.01 g / 0.05 g	±0.02 g / ±0.1 g	10.62 × 8.26 in (270 × 210 mm)	11.81 × 13.98 × 4.37 in (300 × 355 × 111 mm)	207409	\$3,245.00
GX-10202M	10.2 kg	0.01 g	0.01 g	±0.03 g	10.62 × 8.26 in (270 × 210 mm)	11.81 × 13.98 × 4.37 in (300 × 355 × 111 mm)	207410	\$3,995.00
GX-12001M	12.2 kg	0.1 g	0.1 g	±0.2 g	10.62 × 8.26 in (270 × 210 mm)	11.81 × 13.98 × 4.37 in (300 × 355 × 111 mm)	207411	\$3,375.00
GX-22001M	22.2 kg	0.1 g	0.1 g	±0.2 g	10.62 × 8.26 in (270 × 210 mm)	11.81 × 13.98 × 4.37 in (300 × 355 × 111 mm)	207412	\$3,656.00
GX-32001M	32.2 kg	0.1 g	0.1 g	±0.2 g	10.62 × 8.26 in (270 × 210 mm)	11.81 × 13.98 × 4.37 in (300 × 355 × 111 mm)	207413	\$4,215.00
GX-32001MD	6.2 kg / 32.2 kg	0.1 g/1 g	0.1 g / 0.5 g	±0.2 g / ±1 g	10.62 × 8.26 in (270 × 210 mm)	11.81 × 13.98 × 4.37 in (300 × 355 × 111 mm)	207414	\$3,270.00

Options/Accessories

Part#	A&D Model#	Description	Price
207431	GX-04K*	Comparator/output and RS-232C/20 mA interface	\$450.00
207432	GX-06K*	Analog output/20 mA interface	\$525.00
97784	GX-07K**	Waterproof cable for standard RS-232C	\$321.00
102899	GXK-12	Animal weighing pan	\$861.00
102898	GXK-31	Draft shield	\$120.00
97605	AD-100-2	Anti-theft device	\$77.00
97785	AX:073007197A	Protective in-use cover	\$22.00
97649	TB:648	AC adapter (120 V/220 V)	\$45.00
151247	AD-1688	Data logger	\$320.00
196128	AD-8127	Impact dot matrix, statistical printer, includes cable	\$890.00

*GX-04K, GX-06K, replace standard RS-232C and cannot be used at the same time.

IP65 rating does not apply when the GX-04K or the GX-06K is installed.

**Use the GX-07K optional waterproof RS-232C cable, in order to use the standard RS-232 interface for water and dust proof (IP65).



HIGH CAPACITY GF-M Series

Standard Features

- IP65/NEMA Type 4
- RS-232 interface for connecting to printer or PC
- Quick reference operation card
- Time and date
- Vacuum fluorescent display (VFD)
- Interval time setting
- Underhook weighing

Specifications

Weighting Units

Pound, Carat, Pennyweight, Troy Ounce, Grain, Decimal Ounce, Pound/Ounce

Operating Modes

Counting, Percentage

Power

120/240 V AC adapter

Stabilization Time

Approx. 1.5 seconds (typical in FAST mode)

Sensitivity Drift (10° C to 30° C / 50° F to 86° F)

GF-8202M: ±2 ppm/°C
 GF-8202MD: ±3 ppm/°C
 GF-10202M: ±2 ppm/°C
 GF-12001M, GX-22001M, GX-32001M: ±3 ppm/°C
 GF-32001MD: ±5 ppm/°C

Calibration Weight

GF-8202M/MD: 2kg to 8kg
 GF-10202M: 2kg to 10kg
 GF-12001M: 5kg, 10kg
 GF-22001M: 5kg, 10kg, 20kg
 GF-32001M/MD: 5kg, 10kg, 20kg, 30kg

Display Refresh Rate

5 times/second or 10 times/second

Operating Temperature

41° F to 104° F (5° C to 40° C) RH less than 85% (no condensation)

Est. Weight

18.3 lb (8.3 kg)

Warranty

Five-year limited warranty

Model	Capacity	Readability	Repeatability	Linearity	Pan Size	Dimensions	Part #	List Price
GF-8202M	8.2 kg	0.01 g	0.01 g	±0.03 g	10.62 × 8.26 in (270 × 210 mm)	300 × 355 × 111 mm (11.81 × 13.98 × 4.37 in)	207415	\$3,540.00
GF-8202MD	2.2 kg/8.2 kg	0.01 g/0.1 g	0.01 g/0.05 g	±0.02 g/±0.1 g	10.62 × 8.26 in (270 × 210 mm)	300 × 355 × 111 mm (11.81 × 13.98 × 4.37 in)	207416	\$2,990.00
GF-10202M	10.2 kg	0.01 g	0.01 g	±0.03 g	10.62 × 8.26 in (270 × 210 mm)	300 × 355 × 111 mm (11.81 × 13.98 × 4.37 in)	207417	\$3,800.00
GF-12001M	12.2 kg	0.1 g	0.1 g	±0.2 g	10.62 × 8.26 in (270 × 210 mm)	300 × 355 × 111 mm (11.81 × 13.98 × 4.37 in)	207418	\$3,205.00
GF-22001M	22.2 kg	0.1 g	±0.2 g	0.1 g	10.62 × 8.26 in (270 × 210 mm)	300 × 355 × 111 mm (11.81 × 13.98 × 4.37 in)	207419	\$3,400.00
GF-32001M	32.2 kg	0.1 g	±0.2 g	0.1 g	10.62 × 8.26 in (270 × 210 mm)	300 × 355 × 111 mm (11.81 × 13.98 × 4.37 in)	207420	\$3,985.00
GF-32001MD	6.2/32.2 kg	0.1/1 g	±0.5 g/0.1 g	0.2 g/1 g	10.62 × 8.26 in (270 × 210 mm)	300 × 355 × 111 mm (11.81 × 13.98 × 4.37 in)	207422	\$2,999.00

Options/Accessories

Part#	A&D Model#	Description	Price
207431	GX-04K*	Comparator/output and RS-232C/20 mA interface	\$450.00
207432	GX-06K*	Analog output/20 mA interface	\$525.00
97784	GX-07K**	Waterproof cable for standard RS-232C	\$321.00
102899	GXK-12	Animal weighing pan	\$861.00
102898	GXK-31	Draft shield	\$120.00
97605	AD-100-2	Anti-theft device	\$77.00
97785	AX:073007197A	Protective in-use cover	\$22.00
97649	TB:648	AC adapter (120 V/220 V)	\$45.00
151247	AD-1688	Data logger	\$320.00
196128	AD-8127	Impact dot matrix, statistical printer, includes cable	\$890.00

*GX-04K, GX-06K, replace standard RS-232C and cannot be used at the same time. IP65 rating does not apply when the GX-04K or the GX-06K is installed.

**Use the GX-07K optional waterproof RS-232C cable, in order to use the standard RS-232 interface for water and dust proof (IP65).



HIGH CAPACITY GP Series

Standard Features

- IP65/NEMA Type 4
- Internal calibration weight with manual, interval or auto-environmental compensation
- RS-232 interface for connecting to printer or PC
- Data-collection software
- Auto re-zero function
- Time and date
- Bright blue fluorescent display
- Adjustable swing arm display
- Die cast aluminum body with stainless weighing pan
- Detached digital weight indicator (KS models only)

Specifications

Weighing Units:

Carat, Pennyweight, Troy Ounce, Grain, Decimal Ounce, Decimal Pound, Pound/Ounce

Operating Modes:

Counting, Percentage

Power:

Approx. 30 VA (supplied to the AC adapter)

Stabilization Time:

Approx. 1.5 seconds (typical in FAST mode)

Sensitivity Drift (-10 °C to 30 °C):

GP-12K, GP-20K, GP-30K, GP-30KS: ± 3 ppm/°C
 GP-32K, GP-32KS, GP-40K: ± 5 ppm/°C
 GP-60K, GP-60KS, GP-61K, GP-61KS, GP-100K, GP-100KS: ± 6 ppm/°C
 GP102K: ± 10 ppm/°C

Height with Column

652 mm

Calibration Weight:

GP-12K: 5 kg/10 kg
 GP-20K: 10 kg/20 kg
 GP-30K, GP-30KS, GP-32KS: 20 kg/30 kg
 GP-40K: 20/30/40 kg
 GP-60K, GP-60KS: 30/40/50/60 kg
 GP-61K, GP-61KS: 20/30/40/50/60 kg
 GP-100K, GP-100KS, GP-102K: 60/80/100 kg

Operating Temperature:

41° F to 104° F (5° C to 40° C) RH less than 85% (no condensation)

Est. Weight:

Approx. 39.7 lb (18 kg)

Warranty:

Five-year limited

Return Policy:

A&D Weighing Standard Policy - restock fee may apply

Model	Capacity	Readability	Repeatability	Linearity	Pan Size	Dimensions	Part #	List Price
GP-12K	12 kg	0.1 g	0.1 g	± 0.2 g	384 × 344 mm (15 × 13 in)	372 × 615 × 130 mm (14.6 × 24.2 × 5.1 in)	97802	\$3,500.00
GP-20K	21 kg	0.1 g	0.1 g	± 0.2 g	384 × 344 mm (15 × 13 in)	372 × 615 × 130 mm (14.6 × 24.2 × 5.1 in)	97803	\$3,850.00
GP-30K	31 kg	0.1 g	0.1 g	± 0.2 g	384 × 344 mm (15 × 13 in)	344 × 442 × 139 mm (13.5 × 17.4 × 5.5 in)	97805	\$4,650.00
GP-30KS	31 kg	0.1 g	-	-	384 × 344 mm (15 × 13 in)	344 × 442 × 139 mm (13.5 × 17.4 × 5.5 in)	97810	\$4,895.00
GP-32K	31 kg / 6 kg	1/0.1 g	0.5 g / 0.1 g	± 1 / ± 2 g	384 × 344 mm (15 × 13 in)	372 × 615 × 130 mm (14.6 × 24.2 × 5.1 in)	97804	\$3,185.00
GP-32KS	31 kg / 6 kg	1 / 0.1 g	-	-	384 × 344 mm (15 × 13 in)	372 × 615 × 130 mm (14.6 × 24.2 × 5.1 in)	102901	\$3,550.00
GP-40K	41 kg	0.5 g	0.5 g	± 1 g	384 × 344 mm (15 × 13 in)	372 × 615 × 130 mm (14.6 × 24.2 × 5.1 in)	97806	\$4,250.00
GP-60K	61 kg	1 g	0.7 g	± 1 g	384 × 344 mm (15 × 13 in)	372 × 615 × 130 mm (14.6 × 24.2 × 5.1 in)	97807	\$5,225.00
GP-60KS	61 kg	1 g	-	-	384 × 344 mm (15 × 13 in)	372 × 615 × 130 mm (14.6 × 24.2 × 5.1 in)	102902	\$5,450.00
GP-61K	61 kg	0.1 g	0.2 g	± 0.5 g	384 × 344 mm (15 × 13 in)	372 × 615 × 130 mm (14.6 × 24.2 × 5.1 in)	102900	\$5,995.00
GP-61KS	61 kg	0.1 g	-	-	384 × 344 mm (15 × 13 in)	372 × 615 × 130 mm (14.6 × 24.2 × 5.1 in)	102903	\$5,825.00
GP-100K	100 kg	1 g	1 g	± 2 g	384 × 344 mm (15 × 13 in)	372 × 615 × 130 mm (14.6 × 24.2 × 5.1 in)	97808	\$5,500.00
GP-100KS	101 kg	1 g	-	-	384 × 344 mm (15 × 13 in)	372 × 615 × 130 mm (14.6 × 24.2 × 5.1 in)	97811	\$5,925.00
GP-102K	101 kg / 61 kg	10 / 1 g	5 / 1 g	± 10 / ± 2 g	384 × 344 mm (15 × 13 in)	372 × 615 × 130 mm (14.6 × 24.2 × 5.1 in)	97809	\$4,995.00

Options/Accessories

Part#	A&D Model#	Description	Price
97607	AD-1682	Rechargeable battery pack	\$710.00
97608	AD-8920	Universal remote display	\$275.00
97813	GP-04	Comparator output with buzzer	\$264.00
97814	GP-06	Analog output (replaces standard RS-232C)	\$865.00
97815	GP-07	GP extension cable (factory installed 120 day lead time)	\$319.00
97816	GP-20	Underhook GP-12 kg thru 40 kg	\$189.00
97817	GP-21	Underhook GP-60 kg thru 102 kg	\$189.00
97605	AD-100-2	Anti-theft device	\$77.00
97820	07:3004753	Protective in-use cover	\$25.00
97613	TB:136	AC adapter (120 V) standard with unit	\$44.00
97614	TB:137	AC adapter (220 V)	\$55.00
97609	AD-8922	Remote controller	\$650.00
102904	GP-12	Animal weighing pan	\$1,709.00
151247	AD-1688	Data logger	\$320.00
97612	SW:128	Foot switch	\$85.00
196128	AD-8127	Impact dot matrix, statistical printer, includes cable	\$890.00



INTRINSICALLY SAFE EK-AEP Series

Standard Features

- LCD display
- ATEX and FM approved (Class I, Division 1, groups C and D)
- Optical data output
- 200 hours of battery operation*
- Auto power off
- Counting/Percentage/Specific Gravity modes
- Optical data output



EK-300AEP

Specifications

Weighing Units:

Carat, Pennyweight, Troy Ounce, Newton, Decimal Ounce, Decimal Pound

Operating Modes:

Counting, Percentage, Specific Gravity

Power:

Four AA batteries
(Battery life determined with backlight off with four AA batteries. The EK-EAP must be used with any of the following to maintain FM integrity: Duracell AA alkaline MN 1500 LR6, Energizer AA E91 alkaline LR6 AM3, Panasonic AA alkaline LR6 (XJ). Do not mix type or new/used batteries.)

Stabilization Time:

< 2 seconds

Sensitivity Drift (10 °C to 30 °C):

±20 ppm/°C

Calibration Weight:

EK-300AEP: 300 g
EK-3000AEP: 3,000 g
EK-12KAEP: 10 kg

Est. Weight:

3.5 lb (1.5 kg)

Operating Temperature:

32 °F to 104 °F (0 °C to 40 °C)

Warranty:

Two-year limited

Return Policy:

A&D Weighing Standard Policy - restock fee may apply

Approvals:

FM/FMc
ATEX



Model	Capacity	Readability	Repeatability	Linearity	Pan Size	Dimensions	Part #	List Price
EK-300AEP	300 g	0.01 g	0.01 g	±0.02 g	110 mm (Ø4.33 in)	190 × 218 × 55 mm (7.5 × 8.6 × 2.2 in)	199565	\$1,650.00
EK-3000AEP	3,000 g	0.1 g	0.1 g	±0.2 g	133 mm × 170 mm (5.24 in × 6.69 in)	190 × 218 × 55 mm (7.5 × 8.6 × 2.2 in)	199566	\$1,750.00
EK-12KAEP	12,000 g	1 g	1 g	±1 g	133 mm × 170 mm (5.24 in × 6.69 in)	190 × 218 × 55 mm (7.5 × 8.6 × 2.2 in)	199567	\$1,950.00

Options/Accessories

Part #	A&D Model #	Description	Price
177696	EJ-12	Carrying case	\$69.00
202077	AD-1611	Safe area serial output module (requires a fiber optic cable)	\$459.00
202074	AX-KS5456-010	Fiber Optic Cable (10m)	\$328.00
202075	AX-KS5456-030	Fiber Optic Cable (30m)	\$590.00
202076	AX-KS5456-060	Fiber Optic Cable (60m)	\$850.00

*Battery life determined with backlight off with four AA batteries. The EK-EAP must be used with any of the following to maintain FM integrity: Duracell AA alkaline MN 1500 LR6, Energizer AA E91 alkaline LR6 AM3, Panasonic AA alkaline LR6 (XJ). Do not mix type or new/used batteries.



EK-3000AEP

MS-70 / MX-50 / MF-50 / ML-50

Standard Features

- Fast and uniform heating with halogen lamp and uniquely designed (secondary radiation assist) SRA filter
- WinCT[®] communication tools software
- Sodium tartrate dihydrate is provided as a stable moisture content for accuracy checks of the analyzer
- Vacuum fluorescent display (VFD)
- Glass window for heating check and easy cleaning
- Self-check function
- Quick reference card
- RS-232 interface for connecting to printer or PC
- GLP/ GMP/GCP/ISO compliant with time and date, ID, calibration data and check record outputs

Specifications

Operating Modes:

Wet base, Dry base, Solid content, Ratio

Measurement Programs:

Standard, Automatic, Timer, Manual

Power:

120 VAC

Drying Temperature:

MS-70: 30° C to 200° C
 MX-50, MF-50, ML-50: 50° C to 200° C (1° increment)

Measurement Program Memories:

MS-70, MX50: 20 sets
 MF-50: 10 sets
 ML-50: 5 sets

Data Memory:

MS-70, MX-50: 100
 MF-50: 50
 ML-50: 30

Moisture Content Display:

MS-70: 0.001%/0.01%/0.1%
 MX-50: 0.01%/0.1%
 MF-50: 0.05%/0.1%/1%
 ML-50: 0.1%/1%

Moisture Content Accuracy Over 1 g:

MS-70: 0.05%
 MX-50: 0.10%
 MF-50: 0.20%
 ML-50: 0.50%

Over 5 g:

MS-70: 0.01%
 MX-50: 0.02%
 MF-50: 0.05%
 ML-50: 0.10%

Operating Temperature:

40° F to 104° F (5° C to 40° C)

Heating Technology:

Halogen lamp (straight type, 400-Watt max, 5,000 hours)

Est. Weight:

13 lb (5.9 kg)

Warranty:

Five-year limited

Return Policy:

A&D Weighing Standard Policy - restock fee may apply

Model	Capacity	Readability	Pan Size	Dimensions	Part #	List Price
MS-70	71 g	0.0001 g	85 mm (Ø 2.16 in)	215 × 320 × 173 mm (8.46 × 12.6 × 6.8 in)	97821	\$5,875.00
MX-50	51 g	0.001 g	85 mm (Ø 2.16 in)	215 × 320 × 173 mm (8.46 × 12.6 × 6.8 in)	97822	\$3,650.00
MF-50	51 g	0.002 g	85 mm (Ø 2.16 in)	215 × 320 × 173 mm (8.46 × 12.6 × 6.8 in)	97823	\$2,950.00
ML-50	51 g	0.005 g	85 mm (Ø 2.16 in)	215 × 320 × 173 mm (8.46 × 12.6 × 6.8 in)	112408	\$2,552.00

Options/Accessories

Part #	A&D Model #	Description	Price
97824	AX-31	Sample pans (washable, 100 each)	\$100.00
97825	AX-32-2	Glass fiber sheets (100 each)	\$55.00
97826	AX-33	Sodium tartrate dehydrate test samples (30 × 12 g)	\$88.00
97827	AX-34	Halogen lamp (replacement)	\$67.00
97828	AX-35	Pan handles (2 each)	\$29.00
97829	AX-36	Tweezers (2 each)	\$19.00
97830	AX-37	Spoons (2 each)	\$23.00
97831	AX-38	Protective in-use covers (5 each)	\$45.00
97832	AX-39	Dust cover	\$19.00
97833	AX-42	WinCT [®] Moisture (standard for MS-70 and MX-50, option for MF-50)	\$245.00
97834	AD-1700-20G	Calibration mass (20 g)	\$110.00
97837	AX-43	Temperature calibrator (MS-70 and MX-50 only)	\$465.00
151247	AD-1688	Data logger	\$320.00
196128	AD-8127	Impact dot matrix, statistical printer, includes cable	\$890.00



STATIC ELIMINATOR AD-1683

Standard Features

- Can be easily and safely installed; requires no high-voltage wiring
- Eliminates static charges from quickly running or highly electrified work pieces
- Little or no reverse charge is induced by irradiated ions because of its excellent ion polarity or the potential of the charged object
- Achieves static elimination with a huge degree of efficiency regardless of the polarity or the potential of the charged object
- Suited for static elimination in narrow and remote places because of its lengthy ion irradiation distance
- Produces only a little amount of ozone thanks to its high ion generation efficiency
- A current limiting circuit is incorporated in the ion generating electrode to reduce the possibility of electric shock
- No swing in surface potential of the charged object

Specifications

Power:

100 to 240 V AC, 50/60 Hz, 1.5 V AC

Elimination Range:

Distance: 10 to 30 cm from the electrode area: 30 × 30 cm

Static Elimination Method:

DC corona discharge DUAL-DC

Static Eliminating Electrode:

Tungsten emitter

Environmental Conditions:

-5 °C to 40 °C, 35% to 85%RH (non-condensing)

Est. Weight:

300 g

Power:

100 to 240 V AC, 50/60 Hz, 1.5 V AC

Warranty:

One-year limited

Model	Elimination Range	Static Elimination Method	Static Eliminating Electrode	Environmental Conditions	Weight	Part #	List Price
AD-1683	Distance: 10 cm to 30 cm from the electrode area: 30 cm × 30 cm	DC corona discharge DUAL-DC	Tungsten emitter	-5° C to 40° C, 35% to 85%RH (no condensation)	300 g	97610	\$1,275.00

(Below) Example of AD-1683 installation showing static elimination area and an example of ion generation.

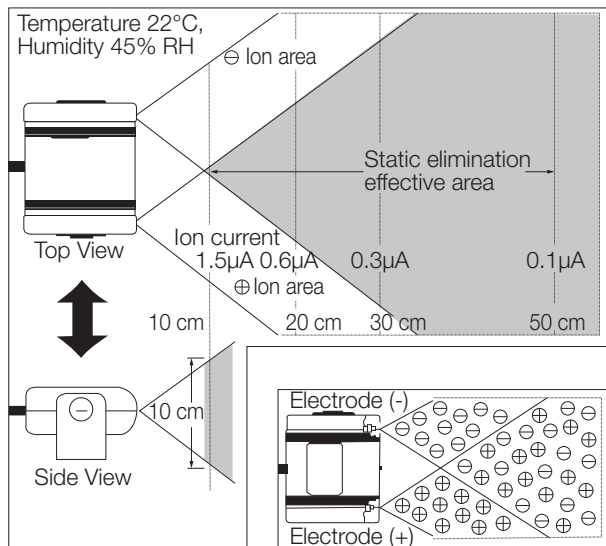

SEMI-MICRO EXPLORER® Series

Standard Features

- Intuitive SmartText™ software
- 4 programmable touchless sensors
- Weighing chamber
- Color touchscreen display
- Memory for up to 99 items
- Real-time clock for GLP/GMP data collection
- Audible stability alert
- Autocal automatic calibration
- EX225D/AD and EX225/AD
- Includes ionizer and auto doors

Specifications

Weighing Units:

Gram, Kilogram, Ounce, Pound, Carat, Pennyweight, Grain, Newton (See technical manual for complete listing)

Operating Modes:

Weighing, Percent Weighing, Parts Counting, Checkweighing, Dynamic/Animal Weighing, Filling, Totalization, Formulation, Differential Weighing, Density Determination, Peak Hold, Pipette Adjustment, SQC

Power Requirements:

AC adapter input: 100 to 240 VAC
0.6A 50 to 60 Hz

Stabilization Time:

0.1 mg = 0.3 seconds; 0.01 mg = 8 second

Min-Weight:

20.0 mg fine range (USP, u=0.10%, k=2)

Calibration:

AutoCal™ on 1.5° C temperature change, 11 hours, and external calibration

Operating Temperature Range:

14° F to 86 °F (-10° C to 30° C)

Est. Weight:

25 lb (12.5 kg)

Warranty:

Two-year limited

Return Policy:

OHAUS Standard Policy - restock fee may apply

Model	Capacity	Readability	Repeatability (20 g) std	Repeatability (100 g) std	Linearity	Pan Size	Dimensions	Part #	List Price
EX125D	52 g/120 g	0.01 mg/ 0.1 mg	±0.015 mg	0.1 mg	±0.1 mg	80 mm	9 × 15.4 × 13.8 in (230 × 393 × 350 mm)	171347	\$6,636.00
EX125	120 g	0.01 mg	±0.015 mg	0.02 mg	±0.1 mg	80 mm	9 × 15.4 × 13.8 in (230 × 393 × 350 mm)	171348	\$8,273.00
EX225D	120 g/220 g	0.01 mg/ 0.1 mg	±0.015 mg	0.02 mg/0.1 mg	±0.1 mg	80 mm	9 × 15.4 × 13.8 in (230 × 393 × 350 mm)	171349	\$8,464.00
EX225D/AD	120 g/220 g	0.01 mg/ 0.1 mg	±0.015 mg	0.02 mg/0.1 mg	±0.1 mg	80 mm	9 × 15.4 × 13.8 in (230 × 393 × 350 mm)	171350	\$8,745.00
EX225/AD	220 g	0.01 mg	±0.015 mg	0.03 mg	±0.1 mg	80 mm	9 × 15.4 × 13.8 in (230 × 393 × 350 mm)	171351	\$10,558.00

Options/Accessories

Part #	Model #	Description	Price
70406	80500525	RS-232 Cable, PC 9-Pin to EX	\$232.00
156234	46001724	Multi-range AC adapter	\$60.00
156235	46001780	International plug set	\$26.00



ANALYTICAL PIONEER® PX Series

Standard Features

- Easy-to-clean analytical draft shield
- Up-front level indicator
- Selectable environment settings
- Flexibility of available options
- Removable doors for easy cleaning and access
- Up-front level bubble for easy reference
- Selectable environmental settings
- Integral underweigh hook
- Standard security bracket
- RS-232 interface for connecting to printer or PC
- Security menu lock
- Backlight display

Specifications

Weighing Units:

Milligram, Gram, Carat, Ounce, Troy Ounce, Grain, Pennyweight, Momme, Ticals, Tola, Baht, Mesghal, Newton, Custom Unit

Operating Modes:

Weighing, Parts Counting, Percent, Density Determination, Dynamic Weighing

Power:

120 VAC adapter (220 to 240 VAC adapter by special order), 50/60 Hz

Stabilization Time Approx:

4 seconds
Calibration Weight
PX84/E: 50/80
PX124/E: 50/100
PX224/E: 100/200

Operating Temperature:

50 °F to 86 °F (10 °C to 30 °C)

Est. Weight:

10 lb (4.5kg)

Warranty:

Two-year limited

Return Policy:

OHAUS Standard Policy - restock fee may apply

Model	Capacity	Readability	Repeatability	Linearity	Weighing Chamber	Pan Size	Dimensions	Part #	List Price
PX84/E	82 g	0.1 mg	0.1 mg	0.2 mg	7.32 × 6.30 × 9.05 in (186 × 160 × 230 mm)	3.54 in (90 mm)	8.2 × 12.6 × 12.2 in (209 × 321 × 309 mm)	191850	\$1,994.00
PX124/E	120 g	0.1 mg	0.1 mg	0.2 mg	7.32 × 6.30 × 9.05 in (186 × 160 × 230 mm)	3.54 in (90 mm)	8.2 × 12.6 × 12.2 in (209 × 321 × 309 mm)	191851	\$2,300.00
PX224/E	220 g	0.1 mg	0.1 mg	0.2 mg	7.32 × 6.30 × 9.05 in (186 × 160 × 230 mm)	3.54 in (90 mm)	8.2 × 12.6 × 12.2 in (209 × 321 × 309 mm)	191852	\$2,553.00

Options/Accessories

Part #	A&D Model #	Description	Price
67413	80850080	TAL software WinWedge®	\$575.00
191875	80850043	Security device for Pioneer	\$279.00
102799	80780009	Forceps, 2.75 in (70 mm)	\$31.00
102800	80780010	Forceps, 3.5 in (89 mm)	\$31.00
33455	80850364	Aluminum scoop, 1.5 in × 2 in (3.8 cm × 5.1 cm), weight 4g	\$44.00
33454	80250048	Black scoop, aluminum 4 in × 3.5 in (10.2 cm × 8.9 cm), weight 24 g	\$45.00
33451	80850359	Polypropylene Maxi-Scoop™ 10 in dia. × 2.5 in deep (25.4 cm dia. × 6.4 cm deep) with pouring spout, weight 145 g	\$44.00
97250	80250400	Stainless steel scoop 11.9 in × 7.38 in × 1.69 in	\$89.00
100292	80250954	Stainless steel scoop 17.2 in × 11 in × 3.4 in (44 cm × 28 cm × 8.5 cm)	\$105.00
156234	46001724	AC adapter (requires 156235 plug set)	\$60.00
156235	46001780	Universal plug set	\$26.00
191876	30472064	Auxiliary display AD7-RS	\$87.00
191877	80253384	Density kit	\$936.00
191878	83034024	Sinker glass for density determination	\$786.00
191879	83021085	USB interface cable	\$232.00
191880	30093334	Dust cover	\$61.00
191881	30372546	In-use cover	\$56.00



Standard Features

- Automatic calibration via AutoCal™
- Communication RS-232C
- On-screen prompts
- Spill channel
- Applications library to store and quickly recall past procedures
- Brilliant backlit, high-resolution dot matrix display with simple navigation windows and menus to guide you through balance functions
- User-selectable GLP outputs via RS-232 to meet traceability requirements
- User-selectable filter, stability indicator and auto-zero tracking for use in difficult environments
- Five-language operation display text
- Standard underweigh capability
- Protective in-use cover and security bracket

OPTIONS:

- NTEP Certified, Legal for Trade models by special order

Specifications

Weighing Units

Milligram, Gram, Kilogram, Ounce, Carat, Pennyweight, Troy Ounce, Grain, Newton (See technical manual for complete listing)

Operating Modes

Weighing, Percent Weighing, Parts Counting, Checkweighing, Dynamic/Animal Weighing, Filling, Totalization, Formulation, Differential Weighing, Density Determination, Peak Hold, Ingredient Costing, Pipette Adjustment, SQC

Power Requirements

AC adapter input: 100-240 VAC 0.6A 50-60 Hz

Stabilization Time

EX124: ≤2 seconds
EX224: ≤2 seconds
EX324: ≤3 seconds

Calibration

AutoCal™ on Δ1.5° C temperature change, 11 hours, and external calibration

Operating Temperature Range

50° F to 86° F (10° C to 30° C)

Est. Weight

21.1 lb (9.6 kg)

Warranty

Two-year limited warranty

Return Policy

OHAUS Standard Policy - restock fee may apply

Model	Capacity	Readability	Repeatability	Linearity	Weighing Chamber	Pan Size	Dimensions	Part #	List Price
EX124	120 g	0.0001 g	±0.0001 g	±0.0002 g	9.5 × 7.5 × 6.5 in (241 × 190 × 165 mm)	Ø 3.5 in (90 mm)	9.1 × 15.5 × 13.8 in (230 × 393 × 350 mm)	121192	\$4,927.00
EX224	220 g	0.0001 g	±0.0001 g	±0.0002 g	9.5 × 7.5 × 6.5 in (241 × 190 × 165 mm)	Ø 3.5 in (90 mm)	9.1 × 15.5 × 13.8 in (230 × 393 × 350 mm)	121193	\$5,475.00
EX324	320 g	0.0001 g	±0.0001 g	±0.0002 g	9.5 × 7.5 × 6.5 in (241 × 190 × 165 mm)	Ø 3.5 in (90 mm)	9.1 × 15.5 × 13.8 in (230 × 393 × 350 mm)	121194	\$6,430.00

Options/Accessories

Part #	Model #	Description	Price
35263	80850043	Security device for EX	\$107.00
77712	80500524	RS-232 cable, PC 25-Pin to EX	\$232.00
70406	80500525	RS-232 Cable, PC 9-Pin to EX	\$232.00
156234	46001724	Multi-range AC adapter	\$60.00
156235	46001780	International plug set	\$26.00



ANALYTICAL ADVENTURER® Series

Standard Features

- Stable, accurate and fast operation, ensuring optimal weighing results
- Color touchscreen with 4.3 in (109 mm) display size
- Dual USB ports and RS-232 provide connectivity options
- Space-saving, top-mounted draft shield on analytical models
- Real time clock with GLP/GMP data
- Below minimum sample weight indication with minimum weight feature
- AutoCal™ automatic calibration

Specifications

Weighing Units:

Milligram, Gram, Kilogram, Ounce, Pound, Carat, Pennyweight, Troy Ounce, Grain, Newton (See technical manual for complete listing)

Operating Modes:

Counting, Weighing, Dynamic Weighing, Check-weighing, Percent Weighing, Totalization, Display Hold, Density Determination, Formulation

Power:

100 to 240 VAC, 0.3A, 50 to 60 HZ AC adapter

Calibration Weight:

AX124: 100 g
AX224: 224 g
AX324: 300 g

Operating Temperature:

50 °F to 86 °F (10 °C to 30 °C)

Est. Weight:

17.2 lb (7.8 kg)

Warranty:

Two-year limited

Model	Capacity	Readability	Repeatability	Linearity	Pan Size	Weighing Chamber	Dimensions	Part #	List Price
AX124	120 g	0.0001 g	1 mg	0.2 mg	3.5 in (90 mm)	9.05 × 13.92 × 13.39 in (230 × 354 × 340 mm)	13.93 × 13.39 × 9.05 in (354 × 340 × 230 mm)	164622	\$3,598.00
AX224	220 g	0.0001 g	1 mg	0.2 mg	3.5 in (90 mm)	9.05 × 13.92 × 13.39 in (230 × 354 × 340 mm)	13.93 × 13.39 × 9.05 in (354 × 340 × 230 mm)	164623	\$3,972.00
AX324	320 g	0.0001 g	1 mg	0.2 mg	3.5 in (90 mm)	9.05 × 13.92 × 13.39 in (230 × 354 × 340 mm)	13.93 × 13.39 × 9.05 in (354 × 340 × 230 mm)	164625	\$4,341.00

Options/Accessories

Part #	Model #	Description	Price
191879	83021085	USB cable, Type A to B	\$232.00
191875	80850043	Security device (laptop lock)	\$279.00
77712	80500524	25-pin RS-232 cable (PC)	\$232.00
70406	80500525	9-pin RS-232 cable (PC)	\$232.00



Standard Features

- Automatic Zero Tracking (AZT)
- Integral LCD display
- Auto-off feature
- Programmable tare
- Transportation lock
- Menu/calibration lockout switch

Specifications

Weighing Units

Gram, Kilogram, Ounce, Pound, Carat, Pennyweight, Troy Ounce, Grain, Pound/Ounce

Operating Modes

Weighing, Parts Counting, Percent Weighing, Checkweighing, Totalization, Density Determination, Display Hold

Power

AC adapter (included) or four AA batteries (not included)

Typical Battery Life

80 hours

Verification Interval

SJX323N/E – 0.01 g
 SJX622N/E and SJX1502N/E – 0.1 g
 SJX6201N/E – 1 g

Draft shield

SJX323N/E – Yes
 SJX622N/E, SJX1502N/E, SJX6201N/E – No

Class

SJX323N/E and SJX1502N/E – II
 SJX622N/E and SJX6201N/E – III

Calibration Weight

SJX323N/E: 50 g
 SJX622N/E: 300 g
 SJX1502M/E: 1.5 kg
 SJX6201N/E: 5 kg

Operating Temperature

Class II: 10° C to 30° C (0° F to 86° F) at 10% to 80% relative humidity, no condensation
 Class III: 10° C to 40° C (50° F to 104° F) at 10% to 80% relative humidity, no condensation

Est. Weight

3.3 lb (1.5 kg)

Warranty

Two-year limited warranty

Approvals

NTEP CC: 16-015
 Measurement Canada: AM-6008



Model	Capacity	Readability	Repeatability	Pan Size	Dimensions	Part #	List Price
SJX323N/E	64 g	0.001 g	0.002 g	Ø 3.7 in (Ø 93 mm)	8 × 8.7 × 4.1 in (202 × 222 × 103 mm)	196652	\$812.00
SJX622N/E	620 g	0.1 g	0.01 g	Ø 4.7 in (Ø 120 mm)	8 × 8.7 × 4.1 in (202 × 222 × 103 mm)	196653	\$1,018.00
SJX1502N/E	1,500 g	0.01 g	0.02 g	6.7 × 5.5 in (170 × 140 mm)	8 × 8.7 × 4.1 in (202 × 222 × 103 mm)	196654	\$1,182.00
SJX6201N/E	6,200 g	1 g	0.1 g	6.7 × 5.5 in (170 × 140 mm)	8 × 8.7 × 4.1 in (202 × 222 × 103 mm)	196655	\$1,044.00



SJX323N/E



SJX622N/E



SJX1502N/E and SJX6201N/E

LEGAL FOR TRADE

VALOR[®] 7000 Series

Standard Features

- Touchless sensors
- Backlit dual LCD display
- Illuminated up-front level indicator
- Internal rechargeable battery
- ABS plastic housing
- Skid-resistant leveling feet
- Menu lock switch
- Multiple application modes
- RS-232 interface for connecting to printer or PC
- Fast stabilizing time

Specifications

Weighing Units:

Pound, Ounce, Kilogram, Gram

Operating Modes:

Weighing, Percent, Checkweighing, Accumulation

Power:

100 to 240 V, internal rechargeable battery 210 hour operation with 12 hour full charge

Stabilization Time:

= 1 second

NTEP Resolution:

V71P1502T: 3 × 0.001 lb

V71P3T: 6 × 0.002 lb

V71P6T: 15 × 0.005 lb

V71P15T: 30 × 0.01 lb

V71P30T: 60 × 0.02 lb

Operating Temperature:

14 °F to 104 °F (-10 °C to 40 °C)

Calibration Weight:

1502T: 1.5kg / 3lb

3T: 3kg / 6lb

6T: 6kg / 15lb

15T: 15kg / 30lb

30T: 30kg / 60lb

Est. Weight:

9.2 lb (4.2 kg)

Warranty:

One-year limited

Return Policy:

OHAUS standard policy - restock fee may apply

Approvals:

NTEP: CC 13-022

Measurement Canada: AM-5907C

OIML: R76/2006-NL1-12-46

NSF



Model	Capacity	Readability	Pan Size	Dimensions	Part #	List Price
V71P1502T	1.5 kg	0.00005 kg	11.8 × 8.9 in (300 × 225 mm)	12.2 × 12.9 × 4.6 in (311 × 327 × 117 mm)	157316	\$821.00
V71P3T	3 kg	0.0001 kg	11.8 × 8.9 in (300 × 225 mm)	12.2 × 12.9 × 4.6 in (311 × 327 × 117 mm)	157317	\$821.00
V71P6T	6 kg	0.0002 kg	11.8 × 8.9 in (300 × 225 mm)	12.2 × 12.9 × 4.6 in (311 × 327 × 117 mm)	157318	\$821.00
V71P15T	15 kg	0.0005 kg	11.8 × 8.9 in (300 × 225 mm)	12.2 × 12.9 × 4.6 in (311 × 327 × 117 mm)	157319	\$821.00
V71P30T	30 kg	0.001 kg	11.8 × 8.9 in (300 × 225 mm)	12.2 × 12.9 × 4.6 in (311 × 327 × 117 mm)	157320	\$821.00

Options/Accessories

Part #	Model #	Description	Price
154638	30037447	Ethernet kit	\$168.00



Standard Features

- Stable, accurate and fast operation, ensuring optimal weighing results
- Color touchscreen with 4.3 in (109 mm) display size
- Dual USB ports and RS-232 provide connectivity options
- Space-saving, top-mounted draft shield on analytical models
- Real time clock with GLP/GMP data
- Below minimum sample weight indication with minimum weight feature
- AutoCal™

Specifications

Weighing Units

Milligram, Gram, Kilogram, Ounce, Pound, Carat, Pennyweight, Troy Ounce, Grain, Newton, Hong Kong Tael, Singapore Tael, Taiwan Tael, Momme, Tical, Baht, Mesghal, Tola, Custom

Operating Modes

Counting, Weighing, Dynamic Weighing, Check-weighing, Percent Weighing, Totalization, Display Hold, Density Determination, Formulation

Power

100 - 240 VAC, 0.3A, 50-60 HZ AC adapter

Class

AX224N: I (0.001 g)
 AX223N/E: II (0.01g)
 AX423N/E and AX523N/E: II (0.01 g)
 AX622N/E, AX1502N/E, AX2202N/E,
 AX4202N/E: II (0.1 g)
 AX8201N/E: II (1 g)

Operating Temperature

10° C to 30° C (50° F to 86° F)

Calibration Weight

224N , AX223 and AX223N/E: 200 g
 AX423: 400 g
 AX523: 500 g
 AX622: 600 g
 1502N/E: 1500g
 2202N/E: 2000g
 4202N/E: 4000g
 8201N/E: 8000g

Est. Weight

AX224N: 17.2 lb (7.8 kg)
 AX223N/E: 12.8 lb (5.8 kg)
 AX423N/E and AX523N/E: 12.8 lb (5.8 kg)
 AX622N/E, AX1502N/E, AX2202N/E,
 AX4202N/E: 14.4 lb (6.5 kg)
 AX8201N/E: 12.6 lb (5.7 kg)

Warranty

Two-year limited warranty

Return Policy

OHAUS Standard Policy - restock fee may apply

Approvals

NTEP CC: 14-082
 Measurement Canada: AM-5957



Model	Capacity	Readability	Repeatability	Linearity	Pan Size	Dimensions	Part #	List Price
NTEP Certified and Measurement Canada Approved								
AX224N	220 g	0.0001 g	2 mg	0.2 mg	3.5 in (90 mm)	13.93 × 13.39 × 9.05 in (354 × 340 × 230 mm)	164624	\$4,215.00
AX223N/E	220 g	0.001 g	0.001 g	0.2 mg	5.1 in (130 mm)	13.93 × 13.39 × 9.05 in (354 × 340 × 230 mm)	164627	\$1,915.00
AX423N/E	420 g	0.001 g	0.001 g	0.002 mg	5.1 in (130 mm)	13.93 × 13.39 × 9.05 in (354 × 340 × 230 mm)	164629	\$2,284.00
AX523N/E	520 g	0.001 g	0.001 g	0.002 mg	5.1 in (130 mm)	13.93 × 13.39 × 9.05 in (354 × 340 × 230 mm)	164632	\$2,537.00
AX622N/E	620 g	0.01 g	0.001 g	0.002 mg	6.9 × 7.7 in (175 × 195 mm)	13.93 × 3.94 × 9.05 in (354 × 100 × 230 mm)	164634	\$1,482.00
AX1502N/E	1,520 g	0.01 g	0.001 g	0.002 mg	6.9 × 7.7 in (175 × 195 mm)	13.93 × 3.94 × 9.05 in (354 × 100 × 230 mm)	164636	\$1,672.00
AX2202N/E	2,200 g	0.01 g	0.01 g	0.002 mg	6.9 × 7.7 in (175 × 195 mm)	13.93 × 3.94 × 9.05 in (354 × 100 × 230 mm)	164638	\$1,857.00
AX4202N/E	4,200 g	0.01 g	0.01 g	0.002 mg	6.9 × 7.7 in (175 × 195 mm)	13.93 × 3.94 × 9.05 in (354 × 100 × 230 mm)	164640	\$2,353.00
AX8201N/E	8,200 g	0.1 g	0.1 g	0.02 mg	6.9 × 7.7 in (175 × 195 mm)	13.93 × 3.94 × 9.05 in (354 × 100 × 230 mm)	164644	\$1,857.00

Options/Accessories

Part #	Model #	Description	Price
191879	83021085	USB cable, Type A to B	\$232.00
191875	80850043	Security device (laptop lock)	\$279.00
77712	80500524	25-pin RS-232 cable (PC)	\$232.00
70406	80500525	9-pin RS-232 cable (PC)	\$232.00



PRECISION

ADVENTURER® Series

Standard Features

- Stable, accurate and fast operation, ensuring optimal weighing results
- Color touchscreen with 4.3 in (109 mm) display size
- Dual USB ports and RS-232 provide connectivity options
- Space-saving, top-mounted draft shield on analytical models
- Real time clock with GLP/GMP data
- Below minimum sample weight indication with minimum weight feature
- AutoCal™ automatic internal calibration for optimized weighing performance

Specifications

Weighing Units:

Milligram, Gram, Kilogram, Ounce, Pound, Carat, Pennyweight, Troy Ounce, Grain, Newton, Hong Kong Tael, Singapore Tael, Taiwan Tael, Momme, Tical, Baht, Mesghal, Tola, Custom

Operating Modes:

Counting, Weighing, Dynamic Weighing, Check-weighing, Percent Weighing, Totalization, Display Hold, Density Determination, Formulation

Power:

100 to 240 VAC, 0.3A, 50 to 60 HZ AC adapter

Stabilization Time:

= 1 second

Calibration Weight:

AX223: 200 g
AX423: 400 g
AX523: 500 g
AX622: 600 g

Operating Temperature:

10 °C to 30 °C (50 °F to 86 °F)

Est. Weight:

AX223, AX423, AX523: 12.8 lb (5.8 kg)

Warranty:

Two-year limited

Return Policy:

OHAUS standard policy - restock fee may apply

Model	Capacity	Readability	Repeatability	Linearity	Pan Size	Dimensions	Part #	List Price
AX223	220 g	0.001 g	0.001 g	0.2 mg	5.1 in (130 mm)	13.93 × 13.39 × 9.05 in (354 × 340 × 230 mm)	164626	\$2,179.00
AX423	420 g	0.001 g	0.001 g	0.002 mg	5.1 in (130 mm)	13.93 × 13.39 × 9.05 in (354 × 340 × 230 mm)	164628	\$2,627.00
AX523	520 g	0.001 g	0.001 g	0.002 mg	5.1 in (130 mm)	13.93 × 13.39 × 9.05 in (354 × 340 × 230 mm)	164630	\$2,870.00
AX622	620 g	0.01 g	0.001 g	0.002 mg	6.9 x 7.7 in (175 × 195 mm)	13.93 × 3.94 × 9.05 in (354 × 100 × 230 mm)	164633	\$1,651.00

Options/Accessories

Part #	Model #	Description	Price
191879	83021085	USB cable, Type A to B	\$232.00
191875	80850043	Security device (laptop lock)	\$279.00
77712	80500524	25-pin RS-232 cable (PC)	\$232.00
70406	80500525	9-pin RS-232 cable (PC)	\$232.00



PRECISION
PIONEER® PX Series

Standard Features

- Easy-to-clean analytical draft shield (select models)
- Up-front level indicator
- Selectable environment settings
- Flexibility of available options
- Removable doors for easy cleaning and access
- Up-front level bubble for easy reference
- Selectable environmental settings
- Integral underweigh hook
- Standard security bracket
- RS-232 interface for connecting to printer or PC
- Security menu lock
- Backlight display

Specifications

Weighing Units:

Milligram, Gram, Carat, Ounce, Troy Ounce, Grain, Pennyweight, Momme, Tael, Tola, Baht, Mesghal, Newton, Custom Unit

Operating Modes:

Weighing, Parts Counting, Percent, Density, Determination, Dynamic Weighing

Power:

120 VAC adapter (220 to 240 VAC adapter by special order), 50/60 Hz

Stabilization Time:

Approx. 4 seconds

Calibration Weight:

PX163/E: 100/150 g
 PX323/E: 200/300 g
 PX523/E: 200/500 g

Operating Temperature:

10°C to 30°C (50°F to 86°F)

Est. Weight:

10 lb (4.5kg)

Warranty:

Two-year limited

Return Policy:

OHAUS Standard Policy - restock fee may apply

Model	Capacity	Readability	Repeatability	Linearity	Pan Size	Dimensions	Part #	List Price
PX163/E	160 g	0.001 g	1 mg	2 mg	4.72 in (120 mm)	8.2 × 12.6 × 12.2 in (209 × 321 × 309 mm)	191853	\$1,161.00
PX323/E	320 g	0.001 g	1 mg	2 mg	4.72 in (120 mm)	8.2 × 12.6 × 12.2 in (209 × 321 × 309 mm)	191854	\$1,350.00
PX523/E	520 g	0.001 g	1 mg	2 mg	4.72 in (120 mm)	8.2 × 12.6 × 12.2 in (209 × 321 × 309 mm)	191855	\$1,709.00

Options/Accessories

Part #	A&D Model #	Description	Price
67413	80850080	TAL software WinWedge®	\$575.00
191875	80850043	Security device for Pioneer	\$279.00
102799	80780009	Forceps, 2.75 in (70 mm)	\$31.00
102800	80780010	Forceps, 3.5 in (89 mm)	\$31.00
33455	80850364	Aluminum scoop, 1.5 in × 2 in (3.8 cm × 5.1 cm), weight 4g	\$44.00
33454	80250048	Black scoop, aluminum 4 in × 3.5 ft (10.2 cm × 8.9 cm), weight 24g	\$45.00
33451	80850359	Polypropylene Maxi-Scoop™ 10 in dia. × 2.5 in deep (25.4 cm dia. × 6.4 cm deep) with pouring spout, weight 145 g	\$44.00
97250	80250400	Stainless steel scoop 11.9 in × 7.38 in × 1.69 in	\$89.00
100292	80250954	Stainless steel scoop 17.2 in × 11 in × 3.4 in (44 cm × 28 cm × 8.5 cm)	\$105.00
156234	46001724	AC adapter (requires 156235 plug set)	\$60.00
156235	46001780	Universal plug set	\$26.00
191876	30472064	Auxiliary display AD7-RS	\$87.00
191877	80253384	Density kit	\$936.00
191878	83034024	Sinker glass for density determination	\$786.00
191879	83021085	USB interface cable	\$232.00
191880	30093334	Dust cover	\$61.00
191881	30372546	In-use cover	\$56.00



PRECISION

EXPLORER® Series

Standard Features

- Capacities from 220 g to 10.2 kg with Readability to 0.001 g
- Large, 5.7 full-color touchscreen display with intuitive setup and application software
- AutoCal™ automatic internal calibration for optimized weighing performance
- 14 application modes, 11 weighing units and 5 display languages for a wide variety of applications
- Four programmable touchless sensors for hands-free operation
- 0.001 g models feature frameless draftshield with anti-static glass, flip-top and large side entry doors on top-mounted bearings

OPTIONS

- External calibration models available upon request

Specifications

Weighing Units:

Milligram, Gram, Kilogram, Ounce, Carat, Pennyweight, Troy Ounce, Grain, Newton (See technical manual for complete listing)

Operating Modes:

Weighing, Percent Weighing, Parts Counting, Checkweighing, Dynamic/Animal Weighing, Filling, Totalization, Formulation, Differential Weighing, Density Determination, Peak Hold, Ingredient Costing, Pipette Adjustment, SQC

Power Requirements:

AC adapter input: 100 to 240 VAC 0.6A 50 to 60 Hz

Stabilization Time:

= 1.5 second

Calibration:

AutoCal™ on $\pm 1.5^\circ\text{C}$ temperature change, 11 hours, and external calibration

Operating Temperature:

10°C to 30°C (50°F to 86°F)

Est. Weight:

21.1 lb (9.6 kg)

Warranty:

Two-year limited

Return Policy:

OHAUS standard policy - restock fee may apply

Model	Capacity	Readability	Repeatability	Linearity	Weighing Chamber	Pan Size	Dimensions	Part #	List Price
EX223	220 g	0.001 g	± 0.001 g	± 0.002 g	9.5 × 7.5 × 6.5 in	Ø 5.1 in (130 mm)	9.1 × 15.5 × 13.8 in (230 × 393 × 350 mm)	121195	\$3,234.00
EX423	420 g	0.001 g	± 0.001 g	± 0.002 g	9.5 × 7.5 × 6.5 in	Ø 5.1 in (130 mm)	9.1 × 15.5 × 13.8 in (230 × 393 × 350 mm)	121196	\$3,782.00
EX623	620 g	0.001 g	± 0.001 g	± 0.002 g	9.5 × 7.5 × 6.5 in	Ø 5.1 in (130 mm)	9.1 × 15.5 × 13.8 in (230 × 393 × 350 mm)	121197	\$4,621.00
EX1103	1,100 g	0.001 g	± 0.001 g	± 0.002 g	9.5 × 7.5 × 6.5 in	Ø 5.1 in (130 mm)	9.1 × 15.5 × 13.8 in (230 × 393 × 350 mm)	121198	\$5,417.00

Options/Accessories

Part #	Model #	Description	Price
35263	80850043	Security device for EX	\$107.00
77712	80500524	RS-232 cable, PC 25-Pin to EX	\$232.00
70406	80500525	RS-232 Cable, PC 9-Pin to EX	\$232.00
156234	46001724	Multi-range AC adapter	\$60.00
156235	46001780	International plug set	\$26.00



Standard Features

- ABS housing and stainless steel pan
- Display type (SPX): backlit LCD, six-digit, seven-segment with white LED backlight
- Display type (STX): full-color touchscreen WQVGA graphic LCD

Specifications

Weighing Units

Gram, Kilogram, Ounce, Pound, Carat, Pennyweight, Troy Ounce, Grain, Newton, Pound/Ounce (See technical manual for complete listing)

Operating Modes

Weighing, Parts Counting, Percent Weighing, Checkweighing, Totalization, Display Hold, Only available on STX models: Animal/Dynamic Weighing, Density Determination, Mole Weighing

Power

Multi-range, multi-plug AC power or battery (uses 4-AA batteries not included)

Stabilization Time

1 second

Typical Battery Life

SPX123, SPX223, SPX422, SPX622, SPX1202, SPX2202, SPX6201: 80 hours
SPX222, SPX421, SPX621, SPX2201, SPX8200: 120 hours

Calibration Weight

SPX123 and STX123: 100 g
SPX223, STX223: 200 g

Operating Temperature

10° C to 40° C (50° F to 104° F);
10% to 85% at 31° C, decreasing linearly to 50% at 40° C (no condensation)

Est. Weight

2.8 lb (1.24 kg)

Warranty

One-year limited warranty

Return Policy

OHAUS standard policy - restock fee may apply

Model	Capacity	Readability	Repeatability	Linearity	Pan Size	Dimensions	Part #	List Price
LCD Model								
SPX123	120 g	0.001 g	2d	0.003 g	Ø 3.7 in (93 mm)	8 × 8.7 × 4.1 in (202 × 222 × 103 mm)	171984	\$812.00
SPX223	220 g	0.001 g	2d	0.001 g	Ø 3.7 in (93 mm)	8 × 8.7 × 4.1 in (202 × 222 × 103 mm)	171985	\$907.00
Touchscreen Model								
STX123	120 g	0.001 g	2d	0.003 g	Ø 3.7 in (93 mm)	8 × 8.7 × 4.1 in (202 × 222 × 103 mm)	171996	\$923.00
STX223	220 g	0.001 g	2d	0.001 g	Ø 3.7 in (93 mm)	8 × 8.7 × 4.1 in (202 × 222 × 103 mm)	171998	\$1,034.00

Options/Accessories

Part #	Model #	Description	Price
67413	80850080	WinWedge® TAL Software	\$575.00
181878	30330714	Power supply, US plug, 110/220 VAC	\$31.00



SPX Round Pan



STX Rectangular Pan

TOPLOADER

PIONEER® PX Series

Standard Features

- Up-front level indicator
- Selectable environment settings
- Flexibility of available options
- Up-front level bubble for easy reference
- Selectable environmental settings
- Integral underweigh hook
- Standard security bracket
- RS-232 interface for connecting to printer or PC
- Security menu lock
- Backlight display

Specifications

Weighing Units

Milligram, Gram, Carat, Ounce, Troy Ounce, Grain, Pennyweight, Momme, Taels, Tical, Tola, Baht, Mesghal, Newton, Custom Unit

Operating Modes

Weighing, Parts Counting, Percent, Density Determination, Dynamic Weighing

Power

120 VAC adapter (220-240 VAC adapter by special order), 50/60 Hz

Stabilization Time

160 g - 520 g: 2 seconds
1,600 g - 4,200 g: One second

Operating Temperature

50°F to 86°F (10°C to 30°C)

Calibration Weight

PX1602/E: 1,000/1,500 g
PX2202/E: 1,000/2,000 g
PX3202/E: 2,000/3,000 g
PX4202/E: 2,000/4,000 g
PX2201/E: 1,000/2,000 g
PX4201/E: 2,000/4,000 g

Est. Weight

160 g - 520 g: 10 lb (4.5 kg)
1,600 g - 4,200 g: 7.7 lb (3.5 kg)

Warranty

Two-year limited warranty

Return Policy

OHAUS Standard Policy - restock fee may apply

Model	Capacity	Readability	Repeatability	Linearity	Pan Size	Dimensions	Part #	List Price
PX1602/E	1,600 g	0.01 g	10 mg	20 mg	7.1 in (180 mm)	8.2 × 12.6 × 3.9 in (209 × 321 × 98 mm)	191856	\$1,118.00
PX2202/E	2,200 g	0.01 g	10 mg	20 mg	7.1 in (180 mm)	8.2 × 12.6 × 3.9 in (209 × 321 × 98 mm)	191857	\$1,224.00
PX3202/E	3,200 g	0.01 g	10 mg	20 mg	7.1 in (180 mm)	8.2 × 12.6 × 3.9 in (209 × 321 × 98 mm)	191858	\$1,472.00
PX4202/E	4,200 g	0.01 g	10 mg	20 mg	7.1 in (180 mm)	8.2 × 12.6 × 3.9 in (209 × 321 × 98 mm)	191859	\$1,672.00
PX2201/E	2,200 g	0.1 g	100 mg	200 mg	7.1 in (180 mm)	8.2 × 12.6 × 3.9 in (209 × 321 × 98 mm)	191860	\$1,039.00
PX4201/E	4,200 g	0.1 g	100 mg	200 mg	7.1 in (180 mm)	8.2 × 12.6 × 3.9 in (209 × 321 × 98 mm)	191861	\$1,197.00

Options/Accessories

Part #	Model #	Description	Price
67413	80850080	TAL software WinWedge®	\$575.00
191875	80850043	Security device for Pioneer	\$279.00
102799	80780009	Forceps, 2.75 in (70 mm)	\$31.00
102800	80780010	Forceps, 3.5 in (89 mm)	\$31.00
33455	80850364	Aluminum scoop, 1.5 in × 2 in (3.8 cm × 5.1 cm), weight 4 g	\$44.00
33454	80250048	Black scoop, aluminum 4 in × 3.5 in (10.2 cm × 8.9 cm), weight 24 g	\$45.00
33451	80850359	Polypropylene Maxi-Scoop™ 10 in dia. × 2.5 in deep (25.4 cm dia. × 6.4 cm deep) with pouring spout, weight 145 g	\$44.00
97250	80250400	Stainless steel scoop 11.9 in × 7.38 in × 1.69 in	\$89.00
100292	80250954	Stainless steel scoop 17.2 in × 11 in × 3.4 in (44 cm × 28 cm × 8.5 cm)	\$105.00
156234	46001724	AC adapter (requires 156235 plug set)	\$60.00
156235	46001780	Universal plug set	\$26.00
191876	30472064	Auxiliary display AD7-RS	\$87.00
191877	80253384	Density kit	\$936.00
191878	83034024	Sinker glass for density determination	\$786.00
191879	83021085	USB interface cable	\$232.00
191880	30093334	Dust cover	\$61.00
191881	30372546	In-use cover	\$56.00



TOPLOADER EXPLORER® Series

Standard Features

- Large, 5.7 full-color touchscreen display with intuitive set up and application software
- AutoCal™ automatic internal calibration for optimized weighing performance
- 14 application modes, 11 weighing units and 5 display languages for a wide variety of applications
- Four programmable touchless sensors for hands-free operation

OPTIONS

- External calibration models available upon request

Specifications

Weighing Units

Milligram, Gram, Kilogram, Ounce, Carat, Pennyweight, Troy Ounce, Grain, Newton (See technical manual for complete listing)

Operating Modes

Weighing, Percent Weighing, Parts Counting, Checkweighing, Dynamic/Animal Weighing, Filling, Totalization, Formulation, Differential Weighing, Density Determination, Peak Hold, Ingredient Costing, Pipette Adjustment, SQC

Power Requirements

AC adapter input: 100-240 VAC 0.6A 50-60 Hz

Stabilization Time

EX2202, EX4202, EX6202, EX10202, EX6201, EX10201: ≤1 seconds

Calibration

AutoCal™ on Δ1.5° C temperature change, 11 hours, and external calibration

Operating Temperature Range

10° C to 30° C (50° F to 86° F)

Est. Weight

EX2202, EX4202: 15 lb (6.8 kg)
EX6202, EX10202, EX6201, EX10201: 16.3 lb (7.4 kg)

Warranty

Two-year limited warranty

Return Policy

OHAUS Standard Policy - restock fee may apply

Model	Capacity	Readability	Repeatability	Linearity	Pan Size	Dimensions	Part #	List Price
EX2202	2,200 g	0.01 g	±0.01 g	±0.02 g	7.5 × 7.9 in (190 × 200 mm)	9.1 × 15.5 × 3.9 in (230 × 393 × 98 mm)	121199	\$3,497.00
EX4202	4,200 g	0.01 g	±0.01 g	±0.02 g	7.5 × 7.9 in (190 × 200 mm)	9.1 × 15.5 × 3.9 in (230 × 393 × 98 mm)	121200	\$4,020.00
EX6202	6,200 g	0.01 g	±0.01 g	±0.02 g	7.5 × 7.9 in (190 × 200 mm)	9.1 × 15.5 × 3.9 in (230 × 393 × 98 mm)	121201	\$4,563.00
EX10202	10,200 g	0.01 g	±0.01 g	±0.02 g	7.5 × 7.9 in (190 × 200 mm)	9.1 × 15.5 × 3.9 in (230 × 393 × 98 mm)	121202	\$5,412.00
EX6201	6,200 g	0.1 g	±0.1 g	±0.1 g	7.5 × 7.9 in (190 × 200 mm)	9.1 × 15.5 × 3.9 in (230 × 393 × 98 mm)	121203	\$3,793.00
EX10201	10,200 g	0.1 g	±0.1 g	±0.1 g	7.5 × 7.9 in (190 × 200 mm)	9.1 × 15.5 × 3.9 in (230 × 393 × 98 mm)	121204	\$4,157.00

Options/Accessories

Part #	Model #	Description	Price
35263	80850043	Security device for EX	\$107.00
77712	80500524	RS-232 cable, PC 25-Pin to EX	\$232.00
70406	80500525	RS-232 Cable, PC 9-Pin to EX	\$232.00
156234	46001724	Multi-range AC adapter	\$60.00
156235	46001780	International plug set	\$26.00



TOPLOADER

ADVENTURER® Series

Standard Features

- AutoCal™ automatic internal calibration for optimized weighing performance
- Stable, accurate and fast operation, ensuring optimal weighing results
- Color touchscreen with 4.3 in (109 mm) display size
- Dual USB ports and RS-232 provide connectivity options
- Real time clock with GLP/GMP data
- Below minimum sample weight indication with minimum weight feature

Specifications

Weighing Units

Milligram, Gram, Kilogram, Ounce, Pound, Carat, Pennyweight, Troy Ounce, Grain, Newton (See technical manual for complete listing)

Operating Modes

Counting, Weighing, Dynamic Weighing, Check-weighing, Percent Weighing, Totalization, Display Hold, Density Determination, Formulation

Power

100 - 240 VAC, 0.3A, 50-60 HZ AC adapter

Est. Weight

AX1502, AX2202, AX4202: 14.4 lb (6.5 kg)
AX8201, AX5202: 12.6 lb (5.7 kg)

Operating Temperature

10° C to 30° C (50° F to 86° F)

Warranty

Two-year limited warranty

Return Policy

OHAUS Standard Policy - restock fee may apply

Model	Capacity	Readability	Repeatability	Linearity	Pan Size	Dimensions	Part #	List Price
AX1502	1,520 g	0.01 g	0.001 g	0.002 mg	6.9 × 7.7 in (175 × 195 mm)	13.93 × 3.94 × 9.05 in (354 × 100 × 230 mm)	164635	\$2,015.00
AX2202	2,200 g	0.01 g	0.01 g	0.002 mg	6.9 × 7.7 in (175 × 195 mm)	13.93 × 3.94 × 9.05 in (354 × 100 × 230 mm)	164637	\$2,147.00
AX4202	4,200 g	0.01 g	0.01 g	0.002 mg	6.9 × 7.7 in (175 × 195 mm)	13.93 × 3.94 × 9.05 in (354 × 100 × 230 mm)	164639	\$2,696.00
AX5202	5,200 g	0.01 g	0.01 g	0.002 mg	6.9 × 7.7 in (175 × 195 mm)	13.93 × 3.94 × 9.05 in (354 × 100 × 230 mm)	164641	\$3,054.00
AX4201	4,200 g	0.1 g	0.1 g	0.02 mg	6.9 × 7.7 in (175 × 195 mm)	13.93 × 3.94 × 9.05 in (354 × 100 × 230 mm)	164642	\$1,778.00
AX8201	8,200 g	0.1 g	0.1 g	0.02 mg	6.9 × 7.7 in (175 × 195 mm)	13.93 × 3.94 × 9.05 in (354 × 100 × 230 mm)	164643	\$2,078.00

Options/Accessories

Part #	Model #	Description	Price
191879	83021085	USB cable, Type A to B	\$232.00
191875	80850043	Security device (laptop lock)	\$279.00
77712	80500524	25-pin RS-232 cable (PC)	\$232.00
70406	80500525	9-pin RS-232 cable (PC)	\$232.00



TOPLOADER NAVIGATOR™ XT Series

Standard Features

- Touchless IR (infrared) sensors minimize keypad use
- Program IR sensor to control zero, print tare, backlight and power functions
- Backlit 0.8 in LCD display for high visibility
- Illuminated level indicator at start-up
- Integrated transportation and calibration lock switch
- Hygienic design for easy cleanup in food, laboratory and industrial applications
- Impact-resistant ABS plastic housing with polished stainless steel spill-resistant pan
- Non-skid leveling feet

Specifications

Weighing Units

Gram, Carat, Ounce, Pound, Carat, Pennyweight, Troy Ounce, Grain, Pound/Ounce, (See technical manual for complete listing)

Operating Modes

Weighing, Percent, Parts Counting, Checkweighing, Display Hold, Accumulation/Totalization

Power

12 VDC 0.42 A AC adapter, 100-240 V, four C-batteries (not included)

Stabilization Time

1 second (NVT4201=1.5 seconds)

Ext. Cal. Mass (optional)

NVT2201: 2 lb (1 kg)
NVT4201: 5 lb (2 kg)
NVT6200: 10 lb (5 kg)
NVT12000: 10 lb (5 kg)
NVT2200: 20 lb (10 kg)

Operating Temperature

10° C to 40° C (50° F to 104° F) at 20%-85% RH

Est. Weight

5.1 lb (2.3 kg)

Warranty

One-year limited warranty

Return Policy

OHAUS Standard Policy - restock fee may apply

Model	Capacity	Readability	Linearity	Pan Size	Dimensions	Part #	List Price
NVT2201	2,200 g	0.1 g	0.1 g/±0.2 g	9.1 × 6.9 in (230 × 174 mm)	9.5 × 9.8 × 2.9 in (240 × 250 × 74 mm)	194607	\$460.00
NVT4201	4,200 g	0.1 g	0.1 g/±0.2 g	9.1 × 6.9 in (230 × 174 mm)	9.5 × 9.8 × 2.9 in (240 × 250 × 74 mm)	194608	\$575.00
NVT6200	6,200 g	1 g	1 g/±2 g	9.1 × 6.9 in (230 × 174 mm)	9.5 × 9.8 × 2.9 in (240 × 250 × 74 mm)	194609	\$575.00
NVT12000	12,000 g	1 g	1 g/±2 g	9.1 × 6.9 in (230 × 174 mm)	9.5 × 9.8 × 2.9 in (240 × 250 × 74 mm)	194610	\$622.00
NVT22000	22,000 g	1 g	1 g/±2 g	9.1 × 6.9 in (230 × 174 mm)	9.5 × 9.8 × 2.9 in (240 × 250 × 74 mm)	194611	\$744.00

Options/Accessories

Part #	Model #	Description	Price
118779	83032107	RS-232 interface kit, Navigator series	\$201.00
118780	83032108	USB interface kit	\$201.00
118781	83032109	Ethernet interface kit	\$201.00
194616	30467963	Carrying case	\$132.00
194615	30467987	Universal AC adapter	\$47.00



TOPLOADER SCOUT® Series

Standard Features

- ABS housing and stainless steel pan
- Display type (SPX): backlit LCD, six-digit, seven-segment with white LED backlight
- Display type (STX): full-color touchscreen WQVGA graphic LCD

Specifications

Weighing Units

Gram, Kilogram, Ounce, Pound, Carat, Pennyweight, Troy Ounce, Grain, Newton, Pound/Ounce (See technical manual for complete listing)

Operating Modes

Weighing, Parts Counting, Percent Weighing, Checkweighing, Totalization, Display Hold, Only available on STX models: Animal/Dynamic Weighing, Density Determination, Mole Weighing

Power

Multi-range, multi-plug AC power or battery (uses four-AA batteries not included)

Stabilization Time

1 second

Typical Battery Life

SPX422, SPX622, SPX1202, SPX2202, SPX6201: 80 hours
SPX222, SPX421, SPX621, SPX2201, SPX8200: 120 hours

Calibration Weight

SPX222, STX222: 200 g
SPX422, SPX421, STX422, SPT421: 400 g
SPX622, SPX621, STX622, STX621: 600 g
SPX1202 and STX1202: 1,000 g
SPX2202, SPX2201, STX2202, STX2201: 2,000 g
SPX6201: 6,000 g
SPX8200: 8,000 g

Operating Temperature

10° C to 40° C (50° F to 104° F);
10% to 85% at 31° C, decreasing linearly to 50% at 40° C (no condensation)

Est. Weight

2.8 lb (1.24 kg)

Warranty

One-year limited warranty

Return Policy

OHAUS standard policy - restock fee may apply

Model	Capacity	Readability	Repeatability	Linearity	Pan Size	Dimensions	Part #	List Price
LCD Model								
SPX222	220 g	0.01 g	1d	0.01 g	Ø 4.7 in (120 mm)	8 × 8.8 × 2.1 in (202 × 224 × 54 mm)	171986	\$591.00
SPX422	420 g	0.01 g	1d	0.01 g	Ø 4.7 in (120 mm)	8 × 8.8 × 2.1 in (202 × 224 × 54 mm)	171987	\$828.00
SPX622	620 g	0.01 g	1d	0.01 g	Ø 4.7 in (120 mm)	8 × 8.8 × 2.1 in (202 × 224 × 54 mm)	171988	\$971.00
SPX1202	1,200 g	0.01 g	2d	0.01 g	6.7 × 5.5 in (170 × 140 mm)	8 × 8.8 × 2.1 in (202 × 224 × 54 mm)	171989	\$1,108.00
SPX2202	2,200 g	0.01 g	2d	0.01 g	6.7 × 5.5 in (170 × 140 mm)	8 × 8.8 × 2.1 in (202 × 224 × 54 mm)	171990	\$1,245.00
SPX421	420 g	0.1 g	1d	0.1 g	Ø 4.7 in (120 mm)	8 × 8.8 × 2.1 in (202 × 224 × 54 mm)	171991	\$326.00
SPX621	620 g	0.1 g	1d	0.1 g	6.7 × 5.5 in (170 × 140 mm)	8 × 8.8 × 2.1 in (202 × 224 × 54 mm)	171992	\$482.00
SPX2201	2,200 g	0.1 g	1d	0.1 g	6.7 × 5.5 in (170 × 140 mm)	8 × 8.8 × 2.1 in (202 × 224 × 54 mm)	171993	\$617.00
SPX6201	6,200 g	0.1 g	1d	0.2 g	6.7 × 5.5 in (170 × 140 mm)	8 × 8.8 × 2.1 in (202 × 224 × 54 mm)	171994	\$1,008.00
SPX8200	8,200 g	1 g	1d	1 g	6.7 × 5.5 in (170 × 140 mm)	8 × 8.8 × 2.1 in (202 × 224 × 54 mm)	171995	\$504.00



SPX Round Pan

TOPLOADER SCOUT® Series

Model	Capacity	Readability	Repeatability	Linearity	Pan Size	Dimensions	Part #	List Price
Touchscreen Model								
STX222	220 g	0.01 g	1d	0.01 g	Ø 4.7 in (120 mm)	8 × 8.8 × 2.1 in (202 × 224 × 54 mm)	171999	\$680.00
STX422	420 g	0.01 g	1d	0.01 g	Ø 4.7 in (120 mm)	8 × 8.8 × 2.1 in (202 × 224 × 54 mm)	172000	\$950.00
STX622	620 g	0.01 g	1d	0.01 g	Ø 4.7 in (120 mm)	8 × 8.8 × 2.1 in (202 × 224 × 54 mm)	172001	\$1,113.00
STX1202	1,200 g	0.01 g	2d	0.01 g	6.7 × 5.5 in (170 × 140 mm)	8 × 8.8 × 2.1 in (202 × 224 × 54 mm)	172002	\$1,271.00
STX2202	2,200 g	0.01 g	2d	0.01 g	6.7 × 5.5 in (170 × 140mm)	8 × 8.8 × 2.1 in (202 × 224 × 54mm)	172003	\$1,419.00
STX421	420 g	0.01 g	1d	0.01 g	Ø 4.7 in (120mm)	8 × 8.8 × 2.1 in (202 × 224 × 54mm)	172004	\$384.00
STX621	620 g	0.1 g	1d	0.01 g	6.7 × 5.5 in (170 × 140mm)	8 × 8.8 × 2.1 in (202 × 224 × 54mm)	172005	\$575.00
STX2201	2,200 g	0.1 g	1d	0.01 g	6.7 × 5.5 in (170 × 140mm)	8 × 8.8 × 2.1 in (202 × 224 × 54mm)	172006	\$728.00
STX6201	6,200 g	0.1 g	1d	0.02 g	6.7 × 5.5 in (170 × 140mm)	8 × 8.8 × 2.1 in (202 × 224 × 54mm)	172007	\$1,150.00
STX8200	8,200 g	1 g	1d	0.01 g	6.7 × 5.5 in (170 × 140mm)	8 × 8.8 × 2.1 in (202 × 224 × 54mm)	172008	\$596.00

Options/Accessories

Part #	Model #	Description	Price
67413	80850080	WinWedge® TAL Software	\$575.00
181878	30330714	Power supply, US plug, 110/220 VAC	\$31.00



STX Rectangular Pan

TOPLOADER

VALOR® 3000 XTREME Series

Standard Features

- Full 304 stainless steel housing with chemical resistant keypad
- Removable stainless steel weighing pan
- USDA approved
- Supports HACCP
- Resolutions up to 20,000d
- SmarText™ user interface
- Bright backlit LCD display
- Convenient up-front level device
- NSF listed
- NTEP CC 08-008 models available by special order

Specifications

Weighing Units

Gram, Kilogram, Ounce, Pound, Decimal, Pound/Ounce, Fractional Ounces (See technical manual for complete listing)

Operating Modes

Weighing, Percent Weighing, Combined Zero/Tare, Specific Gravity

Power

120 V AC adapter (9 V DC, 0.5 A), four 1.5 Volt C batteries (not included)

Stabilization Time

<3 seconds

Battery life

V31XH202, V31XH402, V31X501: 50 hours with alkaline cells
V31XH2, V31X3, V31XH4, V31X6: 120 hours with alkaline cells

Protection Rating

IP44 (non-washdown)

Calibration

Digital external calibration

Operating Temperature

0° C to 40° C (32° F to 104° F)

Est. Weight

10 lb (4.8 kg)

Warranty

One-year limited warranty

Return Policy

OHAUS Standard Policy - restock fee may apply

Approvals

NSF



Model	Capacity	Readability	Pan Size	Dimensions	Part #	List Price
V31XH202	200 g	0.01 g	4.7 in (120 mm)	8.5 × 7.3 × 3 in (218 × 186 × 72 mm)	100283	\$923.00
V31XH402	400 g	0.01 g	4.7 in (120 mm)	8.5 × 7.3 × 3 in (218 × 186 × 72 mm)	117790	\$1,261.00
V31X501	500 g	0.1 g	4.7 in (120 mm)	8.5 × 7.3 × 3 in (218 × 186 × 72 mm)	117789	\$680.00
V31XH2	2 kg	0.1 g	5.8 × 6.2 in (146 × 158 mm)	8.5 × 7.3 × 3 in (218 × 186 × 72 mm)	100284	\$923.00
V31X3	3 kg	1 g	5.8 × 6.2 in (146 × 158 mm)	8.5 × 7.3 × 3 in (218 × 186 × 72 mm)	100285	\$612.00
V31XH4	4 kg	0.1 g	5.8 × 6.2 in (146 × 158 mm)	8.5 × 7.3 × 3 in (218 × 186 × 72 mm)	117792	\$1,261.00
V31X6	6 kg	1 g	5.8 × 6.2 in (146 × 158 mm)	8.5 × 7.3 × 3 in (218 × 186 × 72 mm)	100286	\$612.00

Options/Accessories

Part #	Model #	Description	Price
103119	80251216	Hardshell carrying case for FD and Valor	\$159.00
102756	80251147	Sandwich pan, 11 in × 5.9 in (280 × 150 mm) for Valor Xtreme	\$104.00
102757	80251148	French fries holder pan for Valor 3000 Xtreme	\$104.00
102758	80251149	Ice cream cone holder for Valor 3000 Xtreme	\$104.00
33451	80850359	Polypropylene Maxi-Scoop™ 10 dia × 2.5 in deep (25.4 dia × 6.4 cm deep) with pouring spout, weight 145 g	\$44.00
100292	80250954	Stainless steel scoop 17.2 × 11 × 3.4 in (44 × 28 × 8.5 cm)	\$105.00
97250	80250400	Stainless steel scoop 11.9 × 7.4 × 1.7 in (30 × 18.7 × 4.3 cm)	\$89.00



Standard Features

- Full 304 stainless steel housing with chemical resistant keypad
- Removable stainless steel weighing pan
- USDA approved
- Supports HACCP
- NTEP CC 08-008 models available

Specifications

Weighing Units

Gram, Kilogram, Decimal Ounce, Fractional Ounces, Pound/Ounces (See technical manual for complete listing)

Operating Modes

Weighing, Percent Weighing, Combined Zero/Tare, Specific Gravity

Power

120 V AC adapter (9 V DC, 0.5 A), four 1.5 Volt C batteries (not included)

Stabilization Time

<3 seconds

Battery Life

V31XW301 and V31XW3: 50 hours with alkaline cells
V31XW6: 120 hours with alkaline cells

Protection Rating

IP65

Calibration

Digital external calibration

Operating Temperature

0° C to 40° C (32° F to 104° F)

Est. Weight

10 lb (4.8 kg)

Warranty

One-year limited warranty

Return Policy

OHAUS Standard Policy - restock fee may apply

Approvals

NTEP: CC 08-008



Model	Capacity	Resolution	Pan Size	Dimensions	Part #	List Price
V31XW301	300 g	0.1 g	5.8 × 6.2 in (146 × 158 mm)	8.5 × 7.3 × 3 in (218 × 186 × 72 mm)	100287	\$717.00
NTEP Certified						
V31XW3	3 kg	1 g	5.8 × 6.2 in (146 × 158 mm)	8.5 × 7.3 × 3 in (218 × 186 × 72 mm)	100288	\$702.00
V31XW6	6 kg	2 g	5.8 × 6.2 in (146 × 158 mm)	8.5 × 7.3 × 3 in (218 × 186 × 72 mm)	100289	\$702.00

Options/Accessories

Part#	Model#	Description	Price
103119	80251216	Hardshell carrying case for FD and Valor	\$159.00
102756	80251147	Sandwich pan, 11 in × 5.9 in (280 × 150 mm) for Valor Xtreme	\$104.00
102757	80251148	French fries holder pan for Valor 3000 Xtreme	\$104.00
102758	80251149	Ice cream cone holder for Valor 3000 Xtreme	\$104.00
33451	80850359	Polypropylene Maxi-Scoop™ 10 dia × 2.5 in deep (25.4 dia × 6.4 cm deep) with pouring spout, weight 145 g	\$44.00
100292	80250954	Stainless steel scoop 17.2 × 11 × 3.4 in (44 × 28 × 8.5 cm)	\$105.00
97250	80250400	Stainless steel scoop 11.9 × 7.4 × 1.7 in (30 × 18.7 × 4.3 cm)	\$89.00



TOPLOADER VALOR® 2000 Series Washdown

Standard Features

- Front and rear dual display, 0.8 in (20.5 mm)
- Removable stainless steel platform cover
- Fast 0.5 second stabilization time
- SmarText™ interface
- Knife-proof keypad

Specifications

Weighing Units

Grams, Kilograms, Pounds, Ounces, Pound/Ounce

Operating Modes

Weigh, Checkweigh

Power

Universal AC adapter, 12 VDC 0.7 A internal rechargeable lead acid battery

Stabilization Time

<1 second

Battery Life

50 hours with 1 hour recharge time

Protection Rating

IPX8

Safe Overload

150% of capacity

Calibration

Digital external calibration

Operating Temperature

-10° C to 40° C (14° F to 104° F)

Est. Weight

8.6 lb (3.9 kg)

Warranty

One-year limited warranty

Return Policy

OHAUS Standard Policy - restock fee may apply

Model	Capacity	Readability	Pan Size	Dimensions	Part #	List Price
V22XWE3T	3 kg	0.5 g	7.5x 9.5 in (242 x 190 mm)	10.1 x 11.3 x 4.9 in (256 x 288 x 124 mm)	102771	\$642.00
V22XWE6T	6 kg	1 g	7.5x 9.5 in (242 x 190 mm)	10.1 x 11.3 x 4.9 in (256 x 288 x 124 mm)	102772	\$642.00
V22XWE15T	15 kg	2 g	7.5x 9.5 in (242 x 190 mm)	10.1 x 11.3 x 4.9 in (256 x 288 x 124 mm)	102773	\$642.00

Options/Accessories

Part #	Model #	Description	Price
33451	80850359	Polypropylene Maxi-Scoop™ 10 dia x 2.5 in deep (25.4 dia x 6.4 cm deep) with pouring spout, weight 145 g	\$44.00
97250	80250400	Stainless steel scoop 11.9 x 7.4 x 1.7 in (30 x 18.7 x 4.3 cm)	\$89.00
100292	80250954	Stainless steel scoop 17.2 x 11 x 3.4 in (44 x 28 x 8.5 cm)	\$105.00



TOPLOADER COMPASS CX Series

Standard Features

- Superior RF protection
- Reliable, stable results
- CE listed and FCC Class B Part 15 operation
- Large, removable stainless steel weighing platform
- Low-profile design
- Easy operation
- Low-battery indicator
- Automatic shutoff
- Overload protection
- Push-button calibration

Specifications

Weighing Units

Grams, Pound/Ounce and Newton

Operating Modes

Weighing

Power

3 AA alkaline batteries (included) or AC adapter (not included)

Battery Life

1,000 hours

Stabilization Time

CX221, CX621: 1.5 seconds
CX1201: 2 seconds
CX2200, CX5200, CX221P, CX2200P, CX5200P: 1.5 seconds

Operating Temperature

18° C to 25° C (64° F to 77° F)

Calibration Weight

CX221: 200 g
CX621: 500 g
CX1201, CX2200: 1 kg
CX5200: 2 kg

Est. Weight

0.91 lb (0.47 kg)

Warranty

One-year limited warranty

Return Policy

OHAUS Standard Policy - restock fee may apply

Approvals

CE Listed



Model	Capacity	Readability	Repeatability	Linearity	Pan Size	Dimensions	Part #	List Price
CX221	220 g	0.1 g	0.1 g	±0.1 g	5 × 5.6 in (12.7 × 14.2 cm)	5.3 × 7.9 × 1.6 in (13.5 × 20.1 × 4.1 cm)	195245	\$192.00
CX621	620 g	0.1 g	0.1 g	±0.1 g	5 × 5.6 in (12.7 × 14.2 cm)	5.3 × 7.9 × 1.6 in (13.5 × 20.1 × 4.1 cm)	195246	\$198.00
CX1201	1,200 g	0.1 g	0.1 g	±0.1 g	5 × 5.6 in (12.7 × 14.2 cm)	5.3 × 7.9 × 1.6 in (13.5 × 20.1 × 4.1 cm)	195247	\$210.00
CX2200	2,200 g	1 g	1 g	±1 g	5 × 5.6 in (12.7 × 14.2 cm)	5.3 × 7.9 × 1.6 in (13.5 × 20.1 × 4.1 cm)	195248	\$192.00
CX5200	5,200 g	1 g	1 g	±1 g	5 × 5.6 in (12.7 × 14.2 cm)	5.3 × 7.9 × 1.6 in (13.5 × 20.1 × 4.1 cm)	195249	\$226.00
CX221P	220 g	0.1 g	0.1 g	±0.1 g	5 × 5.6 in (12.7 × 14.2 cm)	5.3 × 7.9 × 1.6 in (13.5 × 20.1 × 4.1 cm)	195250	\$206.00
CX2200P	2,200 g	1 g	1 g	±1 g	5 × 5.6 in (12.7 × 14.2 cm)	5.3 × 7.9 × 1.6 in (13.5 × 20.1 × 4.1 cm)	195251	\$207.00
CX5200P	5,200 g	1 g	1 g	±1 g	5 × 5.6 in (12.7 × 14.2 cm)	5.3 × 7.9 × 1.6 in (13.5 × 20.1 × 4.1 cm)	195252	\$226.00

Options/Accessories

Part #	Model #	Description	Price
195254	30467763	Carrying case	\$79.00
181878	30330714	US power adapter	\$31.00
195256	30333865	AU power adapter	\$32.00
195257	30333866	EU power adapter	\$32.00
195258	30333867	UK power adapter	\$32.00
70434	80850075	Bowl, 1,050 mL	\$66.00



TOPLOADER

COMPASS CR Series

Standard Features

- Basic weighing with simple 2-button keypad
- Superior RF protection
- Large weighing platform
- Stackable design with integrated shipping lock
- Low-battery indicator
- Auto shut-off feature
- Mechanical and software overload protection
- External push-button calibration

Specifications**Weighing Units**

Grams, Pound/Ounces, Pennyweight, Troy Ounces

Operating Modes

Weighing

Power

3 AA batteries (included) (AC adapter is optional)

Stabilization Time

3 seconds

Battery Life

300 hours

Operating Temperature

18° C to 25° C (65° F to 77° F)

Calibration Weight

CR221: 200 g

CR621: 500 g

CR2200: 1 kg

CR5200: 2 kg

Est. Weight

0.875 lb (0.4 kg)

Warranty

One-year limited warranty

Return Policy

OHAUS Standard Policy - restock fee may apply

Model	Capacity	Readability	Repeatability	Linearity	Pan Size	Dimensions	Part #	List Price
CR221	220 g	0.1 g	0.1 g	± 0.1 g	5 × 5.2 in (12.7 × 13.2 cm)	5.5 × 8.1 × 1.6 in (14 × 20.6 × 4.1 cm)	195265	\$137.00
CR621	620 g	0.1 g	0.1 g	± 0.1 g	5 × 5.2 in (12.7 × 13.2 cm)	5.5 × 8.1 × 1.6 in (14 × 20.6 × 4.1 cm)	195266	\$142.00
CR2200	2,200 g	1 g	1 g	± 1 g	5 × 5.2 in (12.7 × 13.2 cm)	5.5 × 8.1 × 1.6 in (14 × 20.6 × 4.1 cm)	195267	\$137.00
CR5200	5,200 g	1 g	1 g	± 1 g	5 × 5.2 in (12.7 × 13.2 cm)	5.5 × 8.1 × 1.6 in (14 × 20.6 × 4.1 cm)	195268	\$189.00

Options/Accessories

Part #	Model #	Description	Price
194615	30467987	Power adapter	\$47.00
195254	30467763	Carrying case	\$79.00
70434	80850075	Bowl, 1,050 mL	\$66.00



TOPLOADER
HH Series

Standard Features

- Large, 0.4 in (10.16 mm), high-contrast backlit liquid crystal display (LCD)
- Low-battery indicator
- Overload and underload indicators
- Automatic shut-off
- Protective snap-on cover
- Rugged plastic construction

Specifications

Weighing Units

Grams, Ounces, Pennyweight, Troy Ounces

Operating Modes

Weighing

Stabilization Time

3 seconds

Power

Battery operated

Maximum overload

150% of capacity

Calibration

HH1200: Factory set

HH120, HH320: Calibration with keypad

Est. Weight

0.34 lb (0.16 kg)

Warranty

One-year limited warranty

Return Policy

OHAUS Standard Policy - restock fee may apply

Model	Capacity	Readability	Linearity	Pan Size	Dimensions	Part #	List Price
HH120D	60 g/120 g	0.1 g/0.2 g	±0.1 g/±0.2 g	3.25 × 3.2 in (83 × 81 mm)	5.35 × 3.25 × 0.8 in (136 × 83 × 20 mm)	52541	\$223.00
HH120	120 g	0.1 g	±0.1 g	3.25 × 3.2 in (83 × 81 mm)	5.35 × 3.25 × 0.8 in (136 × 83 × 20 mm)	64055	\$266.00
HH320	320 g	0.1 g	±0.2 g	3.25 × 3.2 in (83 × 81 mm)	5.35 × 3.25 × 0.8 in (136 × 83 × 20 mm)	52540	\$330.00



TOPLOADER

YA Series

Standard Features

- Smaller size than most pocket scales allows for a comfortable fit in your pocket
- Clamshell case design protects scale during transport
- Bright blue backlit LCD display
- Automatic shutoff

Specifications

Weighing Units

Grams, Ounces, Carats, Grains

Operating Modes

Weighing

Power

Two AAA batteries

Est. Weight

0.3 lb

Calibration

External

Warranty

One-year limited warranty

Return Policy

OHAUS Standard Policy - restock fee may apply

Model	Capacity	Readability	Repeatability	Part #	List Price
YA102	100 g	0.01 g	0.01 g	103106	\$133.00
YA302	300 g	0.05 g	0.05 g	103107	\$115.00

Options/Accessories

Part#	Model#	Description	Price
33455	5076-00	Aluminum scoop, 1.5 × 2 in (3.8 × 5.1 cm), weight 4 g	\$44.00
33454	4590-30	Black scoop, aluminum 4 × 3.5 in (10.2 × 8.9 cm), weight 24 g	\$45.00



TOPLOADER VALOR® 1000 Series

Standard Features

- Removable stainless steel platform cover
- Mid-profile ABS plastic housing
- Front-mounted leveling device
- Compact footprint
- Fast response time
- Easy to clean

Specifications

Weighing Units

Gram, Kilogram, Ounce, Pound, Pound/Ounce

Operating Modes

Weigh, Accumulate, Checkweigh

Power

Universal AC adapter included (9 V DC 500 mA)
Four D Cell Alkaline batteries (not included)

Stabilization Time

≤1.5 seconds

Scale Overload

120% of capacity

Decimal Ounce

V12P3: 105 oz × 0.02 oz
V12P6: 210 oz × 0.05 oz
V12P15: 520 oz × 0.1 oz
V12P30: 1058 oz × 0.5 oz

Decimal Pound

V12P3: 6.6 lb × 0.001 lb
V12P6: 13 lb × 0.002 lb
V12P15: 33 lb × 0.01 lb
V12P30: 66 lb × 0.02 lb

Grams

V12P3: 3,000 g × 0.5 g
V12P6: 6,000 g × 1 g
V12P15: 15,000 g × 2 g
V12P30: 30,000 g × 5 g

Operating Temperature

32° F to 104° F (0° C to 40° C) at 10% to 95% relative humidity non-condensing, up to 2.5 miles/4,000 m above sea level

Est. Weight

8.8 lb (4.0 kg)

Battery life

1,500 hours (with/without backlight on)

Warranty

One-year limited warranty

Return Policy

OHAUS Standard Policy - restock fee may apply

Approvals

NSF



Model	Capacity	Readability	Pan Size	Dimensions	Part #	List Price
V12P3	3 kg	0.5 g	7.5 × 9.8 in (190 × 250 mm)	10.1 × 11 × 4.8 in (256 × 280 × 121 mm)	205019	\$245.00
V12P6	6 kg	1 g	7.5 × 9.8 in (190 × 250 mm)	10.1 × 11 × 4.8 in (256 × 280 × 121 mm)	205020	\$245.00
V12P15	15 kg	2 g	7.5 × 9.8 in (190 × 250 mm)	10.1 × 11 × 4.8 in (256 × 280 × 121 mm)	205021	\$245.00
V12P30	30 kg	5 g	7.5 × 9.8 in (190 × 250 mm)	10.1 × 11 × 4.8 in (256 × 280 × 121 mm)	205023	\$245.00

Options/Accessories

Part #	Model #	Description	Price
33451	80850359	Polypropylene Maxi-Scoop™ 10 dia × 2.5 in deep (25.4 dia × 6.4 cm deep) with pouring spout, weight 145 g	\$44.00
97250	80250400	Stainless steel scoop 11.9 × 7.4 × 1.7 in (30 × 18.7 × 4.3 cm)	\$89.00
100292	80250954	Stainless steel scoop 17.2 × 11 × 3.4 in (44 × 28 × 8.5 cm)	\$105.00



HIGH CAPACITY EXPLORER® Series

Standard Features

- AutoCal™ automatic internal calibration for optimized weighing performance
- Touchless IR (infrared) sensors minimize keypad use
- Program IR sensor to control operations including print, tare and other selectable functions
- Color VGA, 5.7-in display with icons for simple menu navigation
- Multiple application modes designed for versatility
- Robust IP 54 die-cast metal bottom housing with stainless steel pan
- Integral weigh below hook
- ENERGY STAR qualified adapter

Specifications

Weighing Units

Gram, Kilogram, Ounce, Pound, Carat, Pennyweight, Grain (See technical manual for complete listing)

Operating Modes

Weighing, Counting, Animal/Dynamic Weighing, Checkweighing, Percent Weighing, Filling, Parts Counting, Totalization, Formulation, Differential Weighing, Density Determination, Peak Hold, Ingredient Costing, SQC

Power

AC adapter input: 100-240 VAC 0.6A 50-60 Hz

Stabilization Time

1 second

Calibration

AutoCal™ on $\Delta 1.5^\circ\text{C}$ temperature change, 11 hours, and external calibration

Operating Temperature

-10°C to 60°C (14°F to 140°F)

Est. Weight

25 lb (12.5 kg)

Warranty

Two-year limited warranty

Return Policy

OHAUS Standard Policy - restock fee may apply

Model	Capacity	Readability	Repeatability	Linearity	Pan Size	Dimensions	Part #	List Price
Ex12001	12,000 g	0.1 g	± 0.1 g	± 0.2 g	14.84 × 12.24 in (377 × 311 mm)	14.84 × 4.72 × 17.44 in (377 × 120 × 443 mm)	157235	\$4,595.00
Ex24001	24,000 g	0.1 g	± 0.1 g	± 0.2 g	14.84 × 12.24 in (377 × 311 mm)	14.84 × 4.72 × 17.44 in (377 × 120 × 443 mm)	157236	\$5,597.00
Ex35001	35,000 g	0.1 g	± 0.1 g	± 0.2 g	14.84 × 12.24 in (377 × 311 mm)	14.84 × 4.72 × 17.44 in (377 × 120 × 443 mm)	157237	\$6,573.00

Options/Accessories

Part #	Model #	Description	Price
157238	30078082	Tower mount display	\$184.00
77712	80500524	RS-232 cable, PC 25-pin to EX	\$232.00
70406	80500525	RS-232 cable, PC 9-pin to EX	\$232.00
156234	46001724	Multi-range AC adapter	\$60.00
156235	46001780	International plug set	\$26.00



MECHANICAL TRIPLE BEAM

Standard Features

- Notched and tiered beams for easy reading
- Positive poise positioning for repeatability
- Magnetically damped
- Zero adjust compensator
- Optional tare beam vernier dial

Specifications

Tare Range

710-T0: 225 g
760-00: 225 g

Pan Design

710-00: Stainless steel pan
710-T0: Stainless steel pan with tare
720-00: Polypropylene scoop
750-S0: Stainless steel plate
760-00: Stainless steel plate with tare
720-S0: Stainless steel scoop

Calibration

Front beam: 10 × 0.1 g
Middle beam: 500 × 100 g
Rear beam: 100 × 10 g

Est. Weight

8 lb

Warranty

Five-year limited warranty

Return Policy

OHAUS Standard Policy - restock fee may apply

Model	Capacity	Readability	Pan Size	Dimensions	Part #	List Price
710-00	610 g	0.1 g	Ø 6 in (152 mm)	18 × 12 × 9 in (457 × 305 × 229 mm)	33350	\$339.00
710-T0	610 g	0.1 g	Ø 6 in (152 mm)	18 × 12 × 9 in (457 × 305 × 229 mm)	33351	\$413.00
720-00	610 g	0.1 g	-	18 × 12 × 9 in (457 × 305 × 229 mm)	33352	\$397.00
750-S0	610 g	0.1 g	Ø 6 in (152 mm)	18 × 12 × 9 in (457 × 305 × 229 mm)	33355	\$187.00
760-00	610 g	0.1 g	Ø 6 in (152 mm)	18 × 12 × 9 in (457 × 305 × 229 mm)	33357	\$349.00
720-S0	610 g	0.1 g	-	18 × 12 × 9 in (457 × 305 × 229 mm)	33353	\$461.00
730-00	610 g	0.1 g	-	18 × 12 × 9 in (457 × 305 × 229 mm)	33354	\$498.00
1650-00*	610 g	0.1 g	6 in (152 mm)	18 × 12 × 9 in (457 × 305 × 229 mm)	33361	\$436.00
1650-W0*	2,610 g	0.1 g	6 in (152 mm)	18 × 12 × 9 in (457 × 305 × 229 mm)	33362	\$503.00
1610-00*	610 g	0.1 g	6 in (152 mm)	18 × 12 × 9 in (457 × 305 × 229 mm)	33360	\$503.00
TP2611	2,610 g	0.1 g	5.8 × 5.8 in (147 × 147 mm)	18 × 12 × 9 in (457 × 305 × 229 mm)	103109	\$268.00

*Dial-O-Gram models

Options/Accessories

Part #	Model #	Description	Price
33417	80780011	Rod and clamp assembly	\$89.00
33446	80780014	Polypropylene scoop, 12 × 6 × 2.75 in (304 × 152 × 70 mm) footed and counterweighted for balance without tare	\$89.00
33447	80780015	Stainless steel scoop, 12 × 6 × 2.75 in (304 × 152 × 70 mm) footed and counterweighted for balance without tare	\$157.00
33448	80780016	Polypropylene Maxi-Scoop®, 10 in (254 mm) dia. × 2.5 in (70 mm) deep with pouring spout and counterweight	\$142.00
33463	80780017	Vinyl dust cover	\$48.00
33414	80780108	Attachment weight set, metric	\$87.00



MECHANICAL

HARVARD TRIP BALANCE

Standard Features

- Highly versatile, rugged, and accurate
- Two-pan design ideal for comparative weighing
- Built-in sliding masses
- Roberval principle
- Magnetic damping
- Comparative weighing

Specifications

Pan Design

Two pan design; stainless steel plate

Calibration

Top beam 10 lb × 0.1 lb; Bottom beam 200 g × 10 g

Warranty

Five-year limited warranty

Return Policy

OHAUS Standard Policy - restock fee may apply

Model	Capacity	Readability	Pan Size	Dimensions	Part #	List Price
1450-SD	2,000 g	0.1 g	6 in (152 mm)	25 × 18 × 22 in (160 × 240 × 140 mm)	33364	\$453.00
1550-SD	2,000 g	0.1 g	6 in (152 mm)	25 × 18 × 22 in (160 × 240 × 140 mm)	33367	\$485.00
1560-SD	2,000 g	0.1 g	6 in (152 mm)	25 × 18 × 22 in (160 × 240 × 140 mm)	33368	\$507.00

Options/Accessories

Part#	Model#	Description	Price
33461	80850262	Vinyl dust cover for Harvard Trip Balances	\$48.00
33417	80780011	Rod and clamp assembly for Triple Beam or Harvard Trip	\$89.00



DIAL-O-GRAM[®] AND CENT-O-GRAM[®]

Standard Features

- 0.01 g or 0.1 g sensitivity
- Equipped for specific gravity weighing
- Four-tiered notched beams
- Easy-to-read vernier dial on model 310
- See-through poise on model 311
- High precision and remarkable value
- Three-point beam eliminates need for level adjustment
- Quick-zeroing with zero adjust knob

Specifications

Operating Mode

310-00: Dial
311-00: Poise

Platform

Stainless steel (removable) 3.5 × 0.5 in (89 × 13 mm)

Est. Weight

5 lb (2.3 kg)

Calibration

Front beam: 225 g tare
Middle beam: 500 g × 100 g
Rear beam: 100 g × 10 g
Dial: 10 g × 0.1 g

Warranty

Five-year limited warranty

Return Policy

OHAUS Standard Policy - restock fee may apply

Model	Capacity	Readability	Pan Size	Part #	List Price
310-00	310 g	0.01 g	6 in (152 mm)	33371	\$491.00
311-00	311 g	0.01 g	6 in (152 mm)	33370	\$406.00

Options/Accessories

Part #	Model #	Description	Price
33420	80780018	Test tube kit	\$48.00
33462	80780005	Vinyl dust cover	\$48.00
Additional OHAUS Mechanical Balance Accessories			
33414	80780108	Metric attachment mass set	\$87.00
33450	80780006	Polypropylene scoop, 12 in × 6 in 2.75 in (304 × 152 × 70 mm) footed, tare 125 g	\$43.00
33451	80850359	Polypropylene Maxi-Scoop [®] , 10 in (254 mm) dia. × 2.5 in (63 mm) D with pouring spout	\$44.00
33454	80250048	Black scoop, aluminum, 4 in × 3.5 in (102 × 89 mm)	\$45.00
33455	80850364	Aluminum scoop, 1.5 in × 2 in (38 × 51 mm)	\$44.00



MECHANICAL FIELD TEST SCALE

Standard Features

- Affordable compact industrial scale
- Large, stabilized pan can hold oversized samples without tipping
- Readings up to 500 g are taken from a single sliding-weight beam, while a set of slotted weights, stored in the base, can extend the capacity up to 36 lb

Specifications

Operating Mode

Poise

Platform

11 in (279 mm)

Calibration

Bottom beam: 500 g × 5 g
Top beam: 1 lb × 0.01 lb

Est. Weight

12 lb (5.4 kg)

Warranty

Five-year limited warranty

Return Policy

OHAUS Standard Policy - restock fee may apply

Model	Capacity	Readability	Pan Size	Part #	List Price
2400-11	16 kg	5 g	11 in (279 mm)	33379	\$1,804.00
2400-12	36 lb	0.01 lb	11 in (279 mm)	33380	\$1,867.00



MECHANICAL HEAVY DUTY SOLUTION

Standard Features

- Sets an industry standard for precision in high-capacity weighing
- Durable enough to resist corrosion
- Sensitive enough to weigh with a feather's touch
- Large stainless steel platform
- Lockable tare for containers up to 2,270 g
- Self-aligning bearings assure a long, maintenance-free life

Specifications

Operating Mode

Poise

Platform

11 in (279 mm)

Calibrations

Front beam: 100 g × 1 g
Rear beam: 1000 g × 100 g

Est. Weight

42 lb

Warranty

Five-year limited warranty

Return Policy

OHAUS Standard Policy - restock fee may apply

Model	Capacity	Readability	Pan Size	Part #	List Price
1119-DO	20 kg	1 g	11 in (279 mm)	33378	\$2,912.00

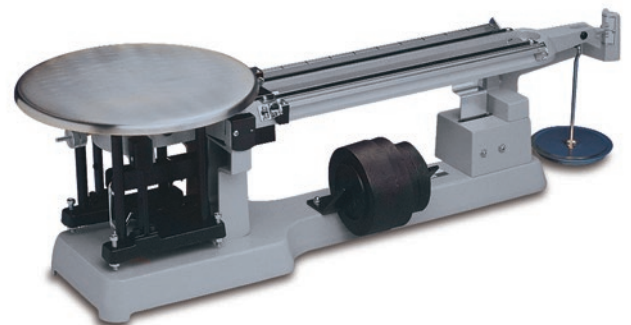

Standard Features

- Fast halogen heating element provides uniform infrared heating and durability for extended use
- Superior weighing performance with readability up to 0.001 g, 0.01% moisture
- Powerful software for simple operation
- Large, backlit liquid crystal display (LCD) for easy viewing (MB23, MB27)
- Bright, easy-to-read touchscreen display (MB90, MB120)
- GLP/GMP compliant format when printed results are required
- RS-232 port for easy communication with printer or PC
- Multi-language display text (English, Spanish, French)

Specifications

Moisture Range

- 110 g: 0.1% to 100%
- 90 g: 0.05% to 100%
- 90 g: 0.01% to 100%
- 120 g: 0.01% to 100% (0.01% to 100% for regain mode)

Power

120 V AC Adapter

Heater Type

- 110 g: Infrared (no glass)
- 90 g - 120 g: Halogen

Timer

- 110 g - 90 g: 1-99 minutes, 30 second increments to 60 minutes
- 90 g: 1-120 minutes in 30 seconds to 60 minute increments, 1 minute increments from 60-120 minutes
- 120 g: 1-120 minutes in 10 second increments

Operating Temperature

- 110 g - 90 g: 5° C to 40° C (41° F to 104° F)
- 90g - 120g: 10° C to 40° C (50° F to 104° F)

Temperature Settings

- 110 g - 90 g: 50° C to 160° C × 5° C (increments)
- 90 g: 40° C to 200° C × 1° C
- 120 g: 40° C to 230° C × 1° C

Est. Weight

14 lb (6.3 kg)

Warranty

Two-year limited warranty

Return Policy

OHAUS Standard Policy - restock fee may apply

Model	Capacity	Readability	Repeatability	Pan Size	Dimensions	Part #	List Price
83999801	110 g	0.01 g	3 g sample-0.3% 10 g sample-0.1%	Ø 9 cm (3.5 in)	7.5 × 6.0 × 14 in (191 × 152 × 356 mm)	109522	\$3,476.00
30251683	90 g	0.001 g	3 g sample-0.2% 10 g sample-0.05%	Ø 9 cm (3.5 in)	6.5 × 5 × 11 in (165 × 127 × 279 mm)	178254	\$3,476.00
30241164	90 g	0.001 g	3 g sample-0.18% 10 g sample-0.02%	Ø 9 cm (3.5 in)	8.3 × 7.7 × 14 in (211 × 196 × 356 mm)	178255	\$4,658.00
30241165	120 g	0.001 g	3 g sample-0.05% 10 g sample-0.015%	Ø 9 cm (3.5 in)	8.3 × 7.7 × 14 in (211 × 196 × 356 mm)	178256	\$5,913.00

Options/Accessories

Part #	Model #	Description	Price
70401	11113857	Temperature calibration kit	\$695.00
70402	80850087	Pads, glass fiber, 200/box	\$124.00
70403	80850086	Sample pans, 80/box, 90 mm diameter	\$79.00
70404	80850088	Reusable sample pans, 3/box	\$243.00
70406	80500525	Cable, 9-pin serial extension	\$232.00
191875	80850043	Security device	\$279.00
67413	80850080	WinWedge® TAL Software	\$575.00



ULTRA-MICRO / MICRO CUBIS® II Series MCA

Standard Features

- Large, high-end, 7in color touchscreen TFT display in 16:9 format
- Modular design
- User configurable and custom designed to meet changing applications
- Meets advanced Pharma compliance including user/password management for security, audit trail function logs and integrated alibi memory
- RS-232 interface for connecting to printer or PC
- M/DH: Automatic glass draft shield
- F: Manual stainless steel draft shield

Specifications

Weighing Units

Milligram, Gram, Kilogram, Ounce, Pound, Carat, Pennyweight, Troy Ounce, Grain, Newton Pound/Ounce, Micrograms (See technical manual for complete listing)

Operating Modes

Mass Unit Conversion, SQ Min Function, ISO-Cal Function, Density Determination (Buoyancy method only with MSE), Calculation, Averaging, Formulation, Percent Weighing, Totalizing, Counting, Customized Identification, Statistics, Time Control Function, Second Tare Memory, Over/Under Checkweighing

Power

120 V AC adapter auto ranging

Stabilization Time

2.7S-2S00-M/F: 7 seconds
6.6S-2S00-M/F, 3.6P-2S00-M: 5 seconds
66S-000-DH, 66P-000-DH, 36S-000-DH, 36P-000-DH: 3.5 seconds

Calibration Weight

2.7S-2S00-M/F: 2 g
6.6S-2S00-M/F: 5 g
3.6P-2S00-M: 3 g
66S-000-DH, 66P-000-DH: 50 g (E2)
36S-000-DH, 36P-000-DH: 20 g (E2)

Weighing Chamber (W × D × H)

8 × 8 × 10.2 in (205 × 205 × 261 mm)

Operating Temperature

5° C to 40° C (41° F to 104° F)

Est. Weight

30 lb

Warranty

Two-year limited warranty

Return Policy

Sartorius Standard Policy - restock fee may apply

Model	Capacity	Readability	Repeatability	Linearity	Pan Size	Dimensions	Part #	List Price
Cubis II								
MCA2.7S- 2S00-M	2.1 g	0.0001 mg	0.25 µg	0.9 µg	Ø 0.8 in (20 mm)	7.55 × 12.72 × 3.46 in 192 mm × 323 mm × 88 mm Chamber Height: 2.75 in (70 mm)	195682	\$39,965.00
MCA2.7S- 2S00-F	2.1 g	0.0001 mg	0.25 µg	0.9 µg	Ø 1.9 in (50 mm)	7.55 × 12.72 × 3.46 in 192 mm × 323 mm × 88 mm Chamber Height: 0.6 in (15 mm) H	195685	\$41,030.00
MCA6.6S- 2S00-M	6.1 g	0.001 mg	0.001 mg	4 µg	Ø 1.2 in (30 mm)	7.55 × 12.72 × 3.46 in 192 mm × 323 mm × 88 mm Chamber Height: 2.75 in (70 mm)	195687	\$31,425.00
MCA6.6S- 2S00-F	6.1 g	0.001 mg	0.001 mg	4 µg	Ø 1.9 in (50 mm)	7.55 × 12.72 × 3.46 in 192 mm × 323 mm × 88 mm Chamber Height: 0.6 in (15 mm)	195690	\$32,495.00
MCA3.6P- 2S00-M	1.1 g / 2.1 g / 3.1 g	0.001 mg / 0.002 mg / 0.005 mg	0.003 /0.004 / 0.005 mg	4 µg	Ø 1.2 in (30 mm)	7.55 × 12.72 × 3.46 in 192 mm × 323 mm × 88 mm Chamber Height: 2.75 in (70 mm)	195692	\$24,235.00
Cubis I								
MSA66S-000-DH	61 g	0.001 mg	0.0015 mg/ 0.004 mg	0.020 mg	1.18 in/1.97 in (30 mm/50 mm)	7.55 × 12.72 × 3.46 in 192 mm × 323 mm × 88 mm Chamber Height: 7.13 in (181 mm)	186390	\$40,165.00
MSA66P-000-DH	12 g/61 g	0.001 mg/ 0.01 mg	0.002 mg/ 0.010 mg	0.020 mg	1.18 in/1.97 in (30 mm/50 mm)	7.55 × 12.72 × 3.46 in 192 mm × 323 mm × 88 mm Chamber Height: 7.13 in (181 mm)	186391	\$36,815.00
MSA36S-000-DH	31 g	0.001 mg	0.0015 mg/ 0.002 mg	0.015 mg	1.18 in (30 mm)	7.55 × 12.72 × 3.46 in 192 mm × 323 mm × 88 mm Chamber Height: 7.13 in (181 mm)	186392	\$34,800.00
MSA36P-000-DH	6 g/31 g	0.001/0.01 mg	0.0015 mg/ 0.008 mg	0.015 mg	1.18 in (30 mm)	7.55 × 12.72 × 3.46 in 192 mm × 323 mm × 88 mm Chamber Height: 7.13 in (181 mm)	186394	\$30,085.00

Options/Accessories

Part #	Model #	Description	Price
Consult	IB	Bluetooth® wireless interface (factory installed)	Consult
Consult	IP	Additional RS-232, 9-Pin connection with PS2 port (factory installed)	Consult
156906	6971987	Power supply, 100-240 V	\$210.00
156908	6900900	Cord, power 220V EU	\$43.00



Standard Features

- State-of-the-art, TFT touchscreen operation
- Fast stabilization time
- Modular design
- User configurable and custom designed to meet changing applications
- Meets advanced Pharma compliance including user/password management for security, audit trail function logs and integrated alibi memory
- RS-232 and USB communication
- Underweigh hook included

OPTIONS

- Bluetooth® wireless technology

Specifications

Weighing Units

Milligram, Gram, Kilogram, Ounce, Pound, Carat, Pennyweight, Troy Ounce, Grain, Newton Pound/Ounce, Micrograms (See technical manual for complete listing)

Operating Modes

Mass Unit Conversion, SQ Min Function, ISO-Cal Function, Density Determination (Buoyancy method only with MSE), Calculation, Averaging, Formulation, Percent Weighing, Totalizing, Counting, Customized Identification, Statistics, Time Control Function, Second Tare Memory, Over/Under Checkweighing

Power

120 V AC adapter auto ranging

Stabilization Time

2.7S-2S00-M/F: 7 seconds
 6.6S-2S00-M/F, 3.6P-2S00-M: 5 seconds

Calibration Weight

2.7S-2S00-M/F: 2 g
 6.6S-2S00-M/F: 5 g
 3.6P-2S00-M: 3 g

Weighing Chamber (W × D × H)

8 × 8 × 10.2 in (205 × 205 × 261 mm)

Operating Temperature

5° C to 40° C (41° F to 104° F)

Est. Weight

30 lb

Warranty

Two-year limited warranty

Return Policy

Sartorius Standard Policy - restock fee may apply

Model	Capacity	Readability	Repeatability	Linearity	Pan Size	Dimensions	Part #	List Price
MCE2.7S- 2S00-M	2.1 g	0.0001 mg	0.25 µg	0.9 µg	Ø 0.8 in (20 mm)	7.55 × 12.72 × 3.46 in 192 mm × 323 mm × 88 mm Chamber Height: 2.75 in (70 mm)	195680	\$39,135.00
MCE2.7S- 2S00-F	2.1 g	0.0001 mg	0.25 µg	0.9 µg	Ø 1.9 in (50 mm)	7.55 × 12.72 × 3.46 in 192 mm × 323 mm × 88 mm Chamber Height: 0.6 in (15 mm) H	195683	\$40,200.00
MCE6.6S- 2S00-M	6.1 g	0.001 mg	0.001 mg	4 µg	Ø 1.2 in (30 mm)	7.55 × 12.72 × 3.46 in 192 mm × 323 mm × 88 mm Chamber Height: 2.75 in (70 mm)	195686	\$30,595.00
MCE6.6S- 2S00-F	6.1 g	0.001 mg	0.001 mg	4 µg	Ø 1.9 in (50 mm)	7.55 × 12.72 × 3.46 in 192 mm × 323 mm × 88 mm Chamber Height: 0.6 in (15 mm)	195689	\$31,660.00
MCE3.6P- 2S00-M	1.1 g / 2.1 g / 3.1 g	0.001 mg / 0.002 mg / 0.005 mg	0.003/0.004/ 0.005 mg	4 µg	Ø 1.2 in (30 mm)	7.55 × 12.72 × 3.46 in 192 mm × 323 mm × 88 mm Chamber Height: 2.75 in (70 mm)	195693	\$23,400.00

Options/Accessories

Part #	Model #	Description	Price
Consult	IB	Bluetooth® wireless interface (factory installed)	Consult
Consult	IP	Additional RS-232, 9-Pin connection with PS2 port (factory installed)	Consult
156906	6971987	Power supply, 100-240V	\$210.00
156908	6900900	Cord, power 220V EU	\$43.00



SEMI-MICRO CUBIS® II MCA Series

Standard Features

- Large, high-end, 7in color touchscreen TFT display in 16:9 format
- Modular design
- User configurable and custom designed to meet changing applications
- Meets advanced Pharma compliance including user/password management for security, audit trail function logs and integrated alibi memory
- RS-232 and USB communication
- Easy cleaning by removing glass doors
- Underweigh hook included
- Manual glass draft shield

Specifications

Weighing Units

Milligram, Gram, Kilogram, Ounce, Pound, Carat, Pennyweight, Troy Ounce, Grain, Newton Pound/Ounce, Micrograms (See technical manual for complete listing)

Operating Modes

Mass Unit Conversion, SQ Min Function, ISO-Cal Function, Density Determination (Buoyancy method only with MSE), Calculation, Averaging, Formulation, Percent Weighing, Totalizing, Counting, Customized Identification, Statistics, Time Control Function, Second Tare Memory, Over/Under Checkweighing

Power

120 V AC adapter auto ranging

Calibration Weight

225S, 225P: 200 g
125P: 100 g

Stabilization Time

225S, 225P, 125P: 2 seconds

Operating Temperature

5° C to 40° C (41° F to 104° F)

Est. Weight

30 lb

Warranty

Two-year limited warranty

Return Policy

Sartorius Standard Policy - restock fee may apply

Model	Capacity	Readability	Repeatability	Linearity	Pan Size	Weighing Chamber	Dimensions	Part #	List Price
MCA225S	220 g	0.01 mg	0.025 mg	0.1 mg	3.3 × 3.3 in (85 × 85 mm)	8 × 8 × 10.2 in (205 × 205 × 261 mm)	16 × 9.8 × 14.6 in (410 × 249 × 370.4 mm)	195698	\$14,790.00
MCA225P	60/120/220 g	0.01/0.02/ 0.05 mg	0.015/0.04 mg	0.15 mg	3.3 × 3.3 in (85 × 85 mm)	8 × 8 × 10.2 in (205 × 205 × 261 mm)	16 × 9.8 × 14.6 in (410 × 249 × 370.4 mm)	195802	\$12,875.00
MCA125P	60/120 g	0.01/0.1 mg	0.015/0.06 mg	0.15 mg	3.3 × 3.3 in (85 × 85 mm)	8 × 8 × 10.2 in (205 × 205 × 261 mm)	16 × 9.8 × 14.6 in (410 × 249 × 370.4 mm)	195803	\$9,595.00

Options/Accessories

Part#	Model #	Description	Price
Consult	DA	Automatic motorized draft shield for analytical balances (factory installed)	Consult
Consult	DI	Automatic motorized draft shield for analytical balances, with integrated ionizer (factory installed)	Consult
Consult	TR	Certificate of compliance and full factory test report (factory installed)	Consult
Consult	IR	Additional RS-232, 25-pin connection (factory installed)	Consult
156906	6971987	Power supply, 100-240 V	\$210.00
156908	6900900	Cord, power 220 V EU	\$43.00
Consult	IB	Bluetooth® wireless interface	Consult
Consult	IP	Additional RS-232, 9-pin connection with PS2 port	Consult



SEMI-MICRO CUBIS® II MCE Series

Standard Features

- State-of-the-art, TFT touchscreen operation
- Modular design
- User configurable and custom designed to meet changing applications
- Meets advanced Pharma compliance including user/password management for security, audit trail function logs and integrated alibi memory
- RS-232 and USB communication
- Easy cleaning by removing glass doors
- Underweigh hook included
- Manual glass draft shield

Specifications

Weighing Units

Milligram, Gram, Kilogram, Ounce, Pound, Carat, Pennyweight, Troy Ounce, Grain, Newton Pound/Ounce, Micrograms (See technical manual for complete listing)

Operating Modes

Mass Unit Conversion, SQ Min Function, ISO-Cal Function, Density Determination (Buoyancy method only with MSE), Calculation, Averaging, Formulation, Percent Weighing, Totalizing, Counting, Customized Identification, Statistics, Time Control Function, Second Tare Memory, Over/Under Checkweighing

Power

120 V AC adapter auto ranging

Calibration Weight

225S, 225P: 200 g
125P: 100 g

Stabilization Time

225S, 225P, 125P: 2 seconds

Operating Temperature

5° C to 40° C (41° F to 104° F)

Est. Weight

30 lb

Warranty

Two-year limited warranty

Return Policy

Sartorius Standard Policy - restock fee may apply

Model	Capacity	Readability	Repeatability	Linearity	Pan Size	Weighing Chamber	Dimensions	Part #	List Price
MCE225S	220 g	0.01 mg	0.025 mg	0.1 mg	3.3 × 3.3 in (85 × 85 mm)	8 × 8 × 10.2 in (205 × 205 × 261 mm)	16 × 9.8 × 14.6 in 410 × 249 × 370.4 mm	195694	\$13,965.00
MCE225P	60/120/220 g	0.01/0.02/ 0.05 mg	0.015/0.04 mg	0.15 mg	3.3 × 3.3 in (85 × 85 mm)	8 × 8 × 10.2 in (205 × 205 × 261 mm)	16 × 9.8 × 14.6 in 410 × 249 × 370.4 mm	195797	\$12,045.00
MCE125P	60/120 g	0.01/0.1 mg	0.015/0.06 mg	0.15 mg	3.3 × 3.3 in (85 × 85 mm)	8 × 8 × 10.2 in (205 × 205 × 261 mm)	16 × 9.8 × 14.6 in 410 × 249 × 370.4 mm	195798	\$8,765.00

Options/Accessories

Part#	Model #	Description	Price
Consult	DA	Automatic motorized draft shield for analytical balances (factory installed)	Consult
Consult	DI	Automatic motorized draft shield for analytical balances, with integrated ionizer (factory installed)	Consult
Consult	TR	Certificate of compliance and full factory test report (factory installed)	Consult
Consult	IR	Additional RS-232, 25-pin connection (factory installed)	Consult
156906	6971987	Power supply, 100-240 V	\$210.00
156908	6900900	Cord, power 220 V EU	\$43.00
Consult	IB	Bluetooth® wireless interface	Consult
Consult	IP	Additional RS-232, 9-pin connection with PS2 port	Consult



SEMI-MICRO

QUINTIX / SECURA Series

Standard Features

- Color capacitive touch with swipe technology
- Simple touch technology
- Monolithic and strain gauge technology
- Aluminum die-cast base, ABS housing
- Integrated level-control
- Mini-USB
- Weigh below hook
- GLP conformance with built-in time and date
- Time and Date

SECURA OPTIONS

- Internal calibration
- Opto-electronic leveling system
- Sqmin safety program
- Analytical draft support ring

Specifications

Operating Modes

Mass Unit Conversion, Counting, Percent Weighing, Averaging

Units of Measure

Gram, Kilogram, Carat, Pound, Ounce, Troy Ounce, Hong Kong Tael, Singapore Tael, Taiwan Tael, Grain, Pennyweights, Milligram, Parts per Pound, China Teal, Mommies, Austrian Carat, Tola, Baht, Mesghal and Newton

Display Type

LCD

Power

12-15 V DC, 4.5 W
AC adapter, 115 V-240 V

Frequency

50-60 Hz

Minimum Weight per USP

Secura 125-1S, Secura 225D-1: 25 mg
Secura 324-1S: 160 mg

External Calibration Weight

Quintix 65-1S: 50 g
Quintix 125D-1S: 100 g
Secura 125-1S: 100 g
Secura 225D-1S: 200 g

Stabilization Time (typical)

Quintix 65-1S: 6 seconds
Quintix 125D-1S: 6/2 seconds
Secura 125-1S: 6 seconds
Secura 225D-1S: 6/2 seconds
Secura 324-1S: 2 seconds

Operating Humidity

Less than 95% RH

Operating Temperature

5° C to 45° C (41° F to 113° F)

Est. Weight

18 lb (7.8 kg)

Warranty

Two-year manufacturer warranty

Return Policy

Sartorius Standard Policy - restock fee may apply

Model	Capacity	Readability	Repeatability	Linearity	Weighing Chamber	Pan Size	Dimensions	Part #	List Price
Quintix									
QUINTIX165-1S	60 g	0.01 mg	0.04 mg	0.1 mg	8.5 in (218 mm)	3.5 in (80 mm)	14.8 × 8.4 × 12.4 in (376 × 214 × 316 mm)	170634	\$6,165.00
QUINTIX125D-1S	60 g/120 g	0.01/0.1 mg	0.04/0.07 mg	0.1/0.2 mg	8.5 in (218 mm)	3.5 in (80 mm)	14.8 × 8.4 × 12.4 in (376 × 214 × 316 mm)	170635	\$6,425.00
Secura									
SECURA125-1S	60 g/120 g	0.01/0.1 mg	0.001 g	0.1 mg	8.5 in (218 mm)	3.15 in (80 mm)	14.8 × 8.4 × 12.4 in (376 × 214 × 316 mm)	170636	\$7,075.00
SECURA225D-1S	120 g/220 g	0.01/0.1 mg	0.001 g	0.1/0.2 mg	8.5 in (218 mm)	3.15 in (80 mm)	14.8 × 8.4 × 12.4 in (376 × 214 × 316 mm)	170380	\$7,430.00

Options/Accessories

Part #	Model #	Description	Price
155847	YCC03-D09	Adapter cable, USB to RS-232	\$64.00



Standard Features

- Simple, color capacitive touch with swipe technology
- Monolithic and strain gauge technology
- Aluminum die-cast base, ABS housing
- Front level bubble
- Mini-USB
- Weigh below hook

QUINTIX AND SECURA OPTIONS

- isoCAL/fully automatic, external calibration
- GLP conformance with built-in time and date

SECURA OPTIONS

- Internal calibration
- Opto-electronic leveling system
- Sqmin safety program
- Analytical draft support ring

Specifications**Operating Modes**

Mass unit conversion, Counting, Percent Weighing, Averaging

Units

Gram, Kilogram, Carat, Pound, Ounce, Troy Ounce, Hong Kong Tael, Singapore Tael, Taiwan Tael, Grain, Pennyweights, Milligram, Parts per Pound, China Teal, Mommies, Austrian Carat, Tola, Baht, Mesghal and Newton

Display Type

LCD

Power Requirements

10-20 V, AC adapter, 115 V-240 V

Frequency

50-60 Hz

Calibration Weight

124-1S: 100 g
224-1S, 213-1S, 313-1S: 200 g
513-1S: 500 g
324-1S: 300 g

Stabilization Time (typical)

3 seconds

Operating Humidity

Less than 95% RH

Operating Temperature

10° C to 30° C (50° F to 86° F)

Est. Weight

11 lb (4.5 kg)

Warranty

Two-year manufacturer warranty

Return Policy

Sartorius Standard Policy - restock fee may apply

Model	Capacity	Readability	Repeatability	Linearity	Weighing Chamber	Pan Size	Dimensions	Part #	List Price
Practum									
PRACTUM124-1S	120 g	0.1 mg	±0.1 mg	±0.3 mg	7.9 in (209 mm)	3.5 in (90 mm)	14.1 × 8.5 × 12.6 in (360 × 216 × 320 mm)	153983	\$2,790.00
PRACTUM224-1S	220 g	0.1 mg	±0.1 mg	±0.3 mg	7.9 in (209 mm)	3.5 in (90 mm)	14.1 × 8.5 × 12.6 in (360 × 216 × 320 mm)	153984	\$3,065.00
Quintix									
QUINTIX124-1S	120 g	0.1 mg	±0.1 mg	0.2 mg	7.9 in (209 mm)	3.5 in (90 mm)	14.1 × 8.5 × 12.6 in (360 × 216 × 320 mm)	153992	\$3,895.00
QUINTIX224-1S	220 g	0.1 mg	±0.1 mg	0.2 mg	7.9 in (209 mm)	3.5 in (90 mm)	14.1 × 8.5 × 12.6 in (360 × 216 × 320 mm)	153993	\$4,410.00
Secura									
SECURA124-1S	120 g	0.1 mg	±0.1 mg	0.2 mg	7.9 in (209 mm)	3.5 in (90 mm)	14.1 × 8.5 × 12.6 in (360 × 216 × 320 mm)	154005	\$4,320.00
SECURA224-1S	220 g	0.1 mg	±0.1 mg	0.2 mg	7.9 in (209 mm)	3.5 in (90 mm)	14.1 × 8.5 × 12.6 in (360 × 216 × 320 mm)	154006	\$4,790.00
SECURA324-1S	320 g	0.1 mg	0.001 g	0.3 mg	8.5 in (218 mm)	3.54 in (90 mm)	14.8 × 8.4 × 12.4 in (376 × 214 × 316 mm)	170637	\$5,640.00

Options/Accessories

Part #	Model #	Description	Price
191429	6971790	AC adapter, 110-240 V, six power plugs	\$61.00
155847	YCC03-D09	Adapter cable, USB to RS-232	\$64.00



ANALYTICAL CUBIS® II MCA Series

Standard Features

- 7 in color touchscreen TFT display in 16:9 format
- Modular design
- User-configurable and custom designed to meet changing applications
- Meets advanced Pharma compliance including user/password management for security, audit trail function logs and integrated alibi memory
- RS-232 and USB communication
- Easy cleaning by removing glass doors
- Underweigh hook included
- Manual glass draft shield

Specifications

Weighing Units

Milligram, Gram, Kilogram, Ounce, Pound, Carat, Pennyweight, Troy Ounce, Grain, Newton Pound/Ounce, Micrograms. (See technical manual for complete listing)

Operating Modes

Mass Unit Conversion, SQ Min Function, ISO-Cal Function, Density Determination (Buoyancy method only with MSE), Calculation, Averaging, Formulation, Percent Weighing, Totalizing, Counting, Customized Identification, Statistics, Time Control Function, Second Tare Memory, Over/Under Checkweighing

Power

120 V AC adapter auto ranging

Stabilization Time

1 second

Calibration Weight

124S: 100 g
224S: 200 g
324S / P: 300 g
524S / P: 500 g

Operating Temperature

5° C to 40° C (41° F to 104° F)

Est. Weight

30 lb

Warranty

Two-year Limited Warranty

Return Policy

Sartorius Standard Policy - restock fee may apply

Model	Capacity	Readability	Repeatability	Linearity	Weighing Chamber	Pan Size	Dimensions	Part #	List Price
MCA with TFT Color Touchscreen									
MCA324P	80/160/320 g	0.1/0.2/0.5 mg	0.1/0.2/0.4 mg	0.5 mg	8 × 8 × 10.2 in (205 × 205 × 261mm)	3.3 × 3.3 in (85 × 85 mm)	16 × 9.8 × 14.6 in (410 × 249 × 370.4 mm)	195805	\$8,745.00
MCA524P	120/240/520 g	0.1/0.2/0.5 mg	0.1/0.2/0.5 mg	0.5 mg	8 × 8 × 10.2 in (205 × 205 × 261mm)	3.3 × 3.3 in (85 × 85 mm)	16 × 9.8 × 14.6 in (410 × 249 × 370.4 mm)	195804	\$9,595.00
MCA124S	120 g	0.1 mg	0.1 mg	0.2 mg	8 × 8 × 10.2 in (205 × 205 × 261mm)	3.3 × 3.3 in (85 × 85 mm)	16 × 9.8 × 14.6 in (410 × 249 × 370.4 mm)	195702	\$7,450.00
MCA224S	220 g	0.1 mg	0.07 mg	0.2 mg	8 × 8 × 10.2 in (205 × 205 × 261mm)	3.3 × 3.3 in (85 × 85 mm)	16 × 9.8 × 14.6 in (410 × 249 × 370.4 mm)	195701	\$8,810.00
MCA324S	320 g	0.1 mg	0.1 mg	0.3 mg	8 × 8 × 10.2 in (205 × 205 × 261mm)	3.3 × 3.3 in (85 × 85 mm)	16 × 9.8 × 14.6 in (410 × 249 × 370.4 mm)	195700	\$9,740.00
MCA524S	520 g	0.1 mg	0.1 mg	0.4 mg	8 × 8 × 10.2 in (205 × 205 × 261mm)	3.3 × 3.3 in (85 × 85 mm)	16 × 9.8 × 14.6 in (410 × 249 × 370.4 mm)	195699	\$11,545.00

Options/Accessories

Part #	Model #	Description	Price
Consult	DA	Automatic motorized draft shield for analytical balances (factory installed)	Consult
Consult	DI	Automatic motorized draft shield for analytical balances, with integrated ionizer (factory installed)	Consult
Consult	TR	Certificate of compliance and full factory test report (factory installed)	Consult
Consult	IR	Additional RS-232, 25-pin connection (factory installed)	Consult
156906	6971987	Power supply, 100-240 V	\$210.00
156908	6900900	Cord, power 220 V EU	\$43.00
Consult	IB	Bluetooth® wireless interface	Consult
Consult	IP	Additional RS-232, 9-pin connection with PS2 port	Consult

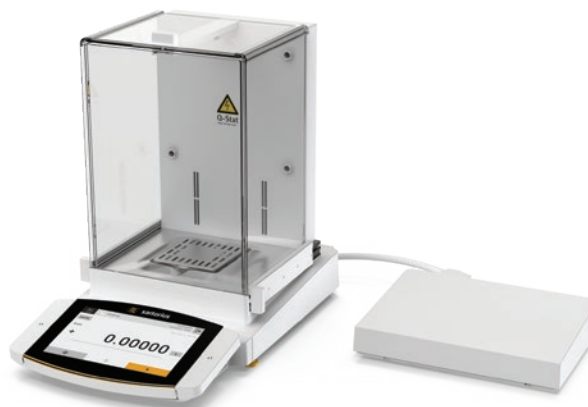

Standard Features

- State-of-the-art TFT touchscreen operation
- Modular design
- User-configurable and custom designed to meet changing applications
- Meets advanced Pharma compliance including user/password management for security, audit trail function logs and integrated alibi memory
- RS-232 and USB communication
- Easy cleaning by removing glass doors
- Underweigh hook included
- Manual glass draft shield

Specifications

Weighing Units

Milligram, Gram, Kilogram, Ounce, Pound, Carat, Pennyweight, Troy Ounce, Grain, Newton Pound/Ounce, Micrograms. (See technical manual for complete listing)

Operating Modes

Mass Unit Conversion, SQ Min Function, ISO-Cal Function, Density Determination (Buoyancy method only with MSE), Calculation, Averaging, Formulation, Percent Weighing, Totalizing, Counting, Customized Identification, Statistics, Time Control Function, Second Tare Memory, Over/Under Checkweighing

Power

120 V AC adapter auto ranging

Stabilization Time

1 second

Calibration Weight

124S: 100 g
224S: 200 g
324S/P: 300 g
524S/P: 500 g

Operating Temperature

5° C to 40° C (41° F to 104° F)

Est. Weight

30 lb

Warranty

Two-year Limited Warranty

Return Policy

Sartorius Standard Policy - restock fee may apply

Model	Capacity	Readability	Repeatability	Linearity	Weighing Chamber	Pan Size	Dimensions	Part #	List Price
MCE with TFT Touchscreen									
MCE324P	80/160/320 g	0.1/0.2/0.5 mg	0.1/0.2/0.4 mg	0.5 mg	8 × 8 × 10.2 in (205 × 205 × 261mm)	3.3 × 3.3 in (85 × 85 mm)	16 × 9.8 × 14.6 in (410 × 249 × 370.4 mm)	195801	\$7,910.00
MCE524P	120/240/520 g	0.1/0.2/0.5 mg	0.1/0.2/0.5 mg	0.5 mg	8 × 8 × 10.2 in (205 × 205 × 261mm)	3.3 × 3.3 in (85 × 85 mm)	16 × 9.8 × 14.6 in (410 × 249 × 370.4 mm)	195800	\$8,765.00
MCE124S	120 g	0.1 mg	0.1 mg	0.2 mg	8 × 8 × 10.2 in (205 × 205 × 261mm)	3.3 × 3.3 in (85 × 85 mm)	16 × 9.8 × 14.6 in (410 × 249 × 370.4 mm)	195697	\$6,620.00
MCE224S	220 g	0.1 mg	0.07 mg	0.2 mg	8 × 8 × 10.2 in (205 × 205 × 261mm)	3.3 × 3.3 in (85 × 85 mm)	16 × 9.8 × 14.6 in (410 × 249 × 370.4 mm)	195696	\$7,975.00
MCE324S	320 g	0.1 mg	0.1 mg	0.3 mg	8 × 8 × 10.2 in (205 × 205 × 261mm)	3.3 × 3.3 in (85 × 85 mm)	16 × 9.8 × 14.6 in (410 × 249 × 370.4 mm)	195695	\$8,905.00
MCE524S	520 g	0.1 mg	0.1 mg	0.4 mg	8 × 8 × 10.2 in (205 × 205 × 261mm)	3.3 × 3.3 in (85 × 85 mm)	16 × 9.8 × 14.6 in (410 × 249 × 370.4 mm)	195799	\$10,720.00

Options/Accessories

Part #	Model #	Description	Price
Consult	DA	Automatic motorized draft shield for analytical balances (factory installed)	Consult
Consult	DI	Automatic motorized draft shield for analytical balances, with integrated ionizer (factory installed)	Consult
Consult	TR	Certificate of compliance and full factory test report (factory installed)	Consult
Consult	IR	Additional RS-232, 25-pin connection (factory installed)	Consult
156906	6971987	Power supply, 100-240 V	\$210.00
156908	6900900	Cord, power 220 V EU	\$43.00
Consult	IB	Bluetooth® wireless interface	Consult
Consult	IP	Additional RS-232, 9-pin connection with PS2 port	Consult



ANALYTICAL ENTRIS II Series Basic Essential

Standard Features

- Backlit LED Touchscreen
- User-friendly operation
- Basic applications
- Monolithic weighing systems
- Aluminum die-cast base, ABS housing
- Front level bubble
- RS-232 standard
- Below balance weighing

Specifications

Weighing Units

Gram, Kilogram, Ounce, Pound, Carat, Pennyweight, Troy Ounce, Grain, Newton (See technical manual for complete listing)

Operating Modes

Weighing, Density, Percentage, Counting, Mass Unit Conversion

Power

AC adapter, 115 V-240 V, US plug

Stabilization Time

2.5 seconds

Operating Humidity

15% to 80% for temperatures up to 31° C

Calibration Weight

BCE64I-1S: 50 g
BCE124I-1S: 100 g
BCE224I-1S: 200 g

Operating Temperature

5° C to 40° C (41° F to 104° F)

Est. Weight

13.7 lb (6.2 kg)

Warranty

Two-year limited warranty

Model	Capacity	Readability	Repeatability	Linearity	Pan Size	Dimensions	Part #	List Price
BCE64I-1S	60 g	0.1 mg	±0.1 mg	±0.2 mg	3.5 in (90 mm)	9.1 × 11.9 × 13 in (230 × 303 × 330 mm)	197392	\$2,465.00
BCE124I-1S	120 g	0.1 mg	±0.1 mg	±0.2 mg	3.5 in (90 mm)	9.1 × 11.9 × 13 in (230 × 303 × 330 mm)	197393	\$2,795.00
BCE224I-1S	220 g	0.1 mg	±0.1 mg	±0.2 mg	3.5 in (90 mm)	9.1 × 11.9 × 13 in (230 × 303 × 330 mm)	197394	\$3,135.00

Options/Accessories

Part#	Model#	Description	Price
112261	YDP20-OCE	Data printer (printer requires power supply part number 191429)	\$1,330.00
31103	6906937	Paper rolls, one roll	\$38.00
31106	6906918	Ink ribbon cassette	\$43.00
201911	YCC-D09MF	Data Cable RS-232, DB-9M to DB-9F (For YDP20 Printer)	\$71.00
204042	YEPS01-PS8	Replacement AC adapter with interchangeable plugs (for use with Entris II)	\$55.00
191429	YEPS01-PS4	AC adapter with interchangeable plugs (for use with YDP20-OCE printer)	\$61.00



ANALYTICAL ENTRIS II Series Basic Advanced

Standard Features

- Graphical Touchscreen
- User-friendly operation
- Basic applications
- Monolithic weighing systems
- Aluminum die-cast base, ABS housing
- Front level bubble
- RS-232 standard
- Below balance weighing

Specifications

Weighing Units

Gram, Kilogram, Carat, Pound, Ounce, Troy Ounce, Hong Kong Tael, Singapore Tael, Taiwan Tael, Grain, Pennyweights, Milligram, Parts per Pound, China Teal, Mommies, Austrian Carat, Tola, Baht, Mesghal, Tons, Pounds, Ounces, Newton

Operating Modes

Weighing, Density, Percentage, Counting, Mass Unit Conversion, Mixing, Statistics, Components, Animal Weighing, Checkweighing, Peak Hold and Pipette Test

Power

AC adapter, 115 V-240 V, US plug

Stabilization Time

BCA64I-1S, BCA124I-1S: 2.5 seconds
BCA224I-1S: 1.3 seconds
BCA324I-1S: 1.0 seconds

Calibration Weight

BCA64I-1S: 50 g
BCA124I-1S: 100 g
BCA224I-1S, BCA324I-1S: 200 g

Operating Temperature

5° C to 40° C (41° F to 104° F)

Operating Humidity

15% to 80% for temperatures up to 31° C

Est. Weight

13.7 lb (6.2 kg)

Warranty

Two-year limited warranty

Model	Capacity	Readability	Repeatability	Linearity	Pan Size	Dimensions	Part #	List Price
BCA64I-1S	60 g	0.1 mg	±0.1 mg	±0.2 mg	3.5 in (90 mm)	20.67 × 19.49 × 15.75 in (52.5 × 49.5 × 40 cm)	202468	\$3,585.00
BCA124I-1S	120 g	0.1 mg	±0.1 mg	±0.2 mg	3.5 in (90 mm)	20.67 × 19.49 × 15.75 in (52.5 × 49.5 × 40 cm)	202469	\$3,915.00
BCA224I-1S	220 g	0.1 mg	±1 mg	±2 mg	4.7 in (120 mm)	20.67 × 19.49 × 15.75 in (52.5 × 49.5 × 40 cm)	202471	\$4,345.00
BCA324I-1S	320 g	0.1 mg	±1 mg	±2 mg	4.7 in (120 mm)	20.67 × 19.49 × 15.75 in (52.5 × 49.5 × 40 cm)	202473	\$4,780.00

Options/Accessories

Part #	Model #	Description	Price
112261	YDP20-OCE	Data printer (printer requires power supply part number 191429)	\$1,330.00
31103	6906937	Paper rolls, one roll	\$38.00
31106	6906918	Ink ribbon cassette	\$43.00
201911	YCC-D09MF	Data Cable RS-232, DB-9M to DB-9F (For YDP20 Printer)	\$71.00
204042	YEPS01-PS8	Replacement AC adapter with interchangeable plugs (for use with Entris II)	\$55.00
191429	YEPS01-PS4	AC adapter with interchangeable plugs (for use with YDP20-OCE printer)	\$61.00



LEGAL FOR TRADE SECURA Series

NEW
NOW NTEP Certified

Standard Features

- Simple, color capacitive touch with swipe technology
- Monolithic and strain gauge technology
- Aluminum die-cast base, ABS housing
- Front level bubble
- Mini-USB
- Weigh below hook

OPTIONS

- isoCAL/fully automatic, external calibration
- Internal calibration
- Opto-electronic leveling system
- GLP conformance with built-in time and date
- Sqmin safety program
- Analytical draft support ring

Specifications

Weighing Units

Mass Unit Conversion, Counting, Percent Weighing, Averaging

Units of Measure

Gram, Kilogram, Carat, Pound, Ounce, Troy Ounce, Hong Kong Tael, Singapore Tael, Taiwan Tael, Grain, Pennyweights, Milligram, Parts per Pound, China Teal, Mommies, Austrian Carat, Tola, Baht, Mesghal and Newton

Display Type

LCD

AC Power Requirements

AC adapter, 115 V-240 V

Frequency

50-60 Hz

Stabilization Time (typical)

3 seconds

Operating Humidity

Less than 95% RH

External Calibration Weight

224-1NUS, 313-1NUS: 200 g
613-1NUS: 500 g
1102-1NUS, 1103-1NUS: 1,000 g
3102-1NUS: 3000g
6101-1NUS, 6102-1NUS: 6000g

Operating Temperature

50° F to 86° F (10° C to 30° C)

Est Weight

9 lb (4.5 kg)

Warranty

Two-year limited warranty

Approvals

NTEP CC: 21-013



Model	Capacity	Readability	Repeatability	Linearity	Pan Size	Dimensions	Part #	List Price
SECURA224-1NUS	220 g	0.1 g	0.5 mg	1 mg	4.73 in (120 mm)	14.1 × 8.5 × 12.6 in (360 × 216 × 320 mm)	207602	\$4,790.00
SECURA313-1NUS	310 g	0.001 g	0.5 mg	2 mg	4.73 in (120 mm)	14.1 × 8.5 × 12.6 in (360 × 216 × 320 mm)	207603	\$2,875.00
SECURA613-1NUS	610 g	0.001 g	0.5 mg	2 mg	4.73 in (120 mm)	14.1 × 8.5 × 12.6 in (360 × 216 × 320 mm)	207604	\$3,835.00
SECURA1102-1NUS	1,100 g	0.01 g	5 mg	0.02 g	7.01 in (180 mm)	14.1 × 8.5 × 12.6 in (360 × 216 × 320 mm)	207605	\$2,515.00
SECURA1103-1NUS	1,100 g	0.001 g	0.5 mg	2 mg	4.73 in (120 mm)	14.1 × 8.5 × 12.6 in (360 × 216 × 320 mm)	207606	\$5,585.00
SECURA3102-1NUS	3,100 g	0.01 g	5 mg	0.02 g	7.01 in (180 mm)	14.1 × 8.5 × 12.6 in (360 × 216 × 320 mm)	207607	\$3,240.00
SECURA6101-1NUS	6,100 g	0.1 g	50 mg	0.1 g	7.01 in (180 mm)	14.1 × 8.5 × 12.6 in (360 × 216 × 320 mm)	207608	\$2,765.00
SECURA6102-1NUS	6,100 g	0.01 g	5 mg	0.02 g	7.01 in (180 mm)	14.1 × 8.5 × 12.6 in (360 × 216 × 320 mm)	207609	\$3,955.00

Options/Accessories

Part #	Model #	Description	Price
191429	6971790	AC adapter, 110-240 V, six power plugs	\$61.00
155847	YCC03-D09	Adapter cable, USB to RS-232	\$64.00





Standard Features

- Backlit LED Touchscreen
- User-friendly operation
- Basic applications
- Monolithic weighing systems
- Aluminum die-cast base, ABS housing
- Front level bubble
- RS-232
- Weigh below hook
- NTEP Certified

Specifications

Weighing Units

Gram, Kilogram, Carat, Pound, Ounce, Troy Ounce, Hong Kong Tael, Singapore Tael, Taiwan Tael, Grain, Pennyweights, Milligram, Parts per Pound, China Teal, Mommies, Austrian Carat, Tola, Baht, Mesghal, Tons, Pounds, Ounces, Newton

Applications

Weighing, Density, Percentage, Counting, Mass Unit Conversion

Display Type

Backlit LCD, 15 mm digits

Operating Humidity

15% to 80% for temperatures up to 31° C

Operating Temperature

41° F to 104° F (5° C to 40° C)

External Calibration Weight

BCE124-1NUS: 100 g
 BCE224-1NUS, BCE324-1NUS: 200 g
 BCE623-1NUS, BCE653-1NUS, BCE622-1NUS, BCE1202-1NUS: 500 g
 BCE3202-1NUS, BCE4202-1NUS, BCE5201-1NUS, BCE6202-1NUS: 5,000 g

Stabilization Time (Typical)

2.5 seconds

Est. Weight

13.7 lb (6.2 kg)

Pan Type

Stainless steel

AC Power Requirements

AC adapter, 115 V-240 V, US plug

Warranty

Two-year limited warranty



Model	Capacity	Readability	NTEP Repeatability	Pan Size	Dimensions	Part #	List Price
BCE124-1NUS	120 g	0.1 mg	1 mg	3.5 in (90 mm)	20.67 × 19.49 × 15.75 in (52.5 × 49.5 × 40 cm)	208212	\$2,465.00
BCE224-1NUS	220 g	0.1 mg	1 mg	3.5 in (90 mm)	20.67 × 19.49 × 15.75 in (52.5 × 49.5 × 40 cm)	208213	\$2,795.00
BCE324-1NUS	320 g	1 mg	10 mg	4.7 in (120 mm)	20.67 × 19.49 × 15.75 in (52.5 × 49.5 × 40 cm)	208214	\$1,450.00
BCE623-1NUS	620 g	1 mg	10 mg	4.7 in (120 mm)	20.67 × 19.49 × 15.75 in (52.5 × 49.5 × 40 cm)	208215	\$2,125.00
BCE653-1NUS	650 g	1 mg	10 mg	4.7 in (120 mm)	20.67 × 19.49 × 15.75 in (52.5 × 49.5 × 40 cm)	208216	\$2,355.00
BCE622-1NUS	620 g	10 mg	0.1 g	4.7 in (120 mm)	20.67 × 19.49 × 15.75 in (52.5 × 49.5 × 40 cm)	208217	\$1,120.00
BCE1202-1NUS	1200 g	10 mg	0.1 g	4.7 in (120 mm)	20.67 × 19.49 × 15.75 in (52.5 × 49.5 × 40 cm)	208218	\$1,345.00
BCE3202-1NUS	3200 g	10 mg	0.1 g	4.7 in (120 mm)	20.67 × 19.49 × 15.75 in (52.5 × 49.5 × 40 cm)	208219	\$1,565.00
BCE4202-1NUS	4200 g	10 mg	0.1 g	4.7 in (120 mm)	20.67 × 19.49 × 15.75 in (52.5 × 49.5 × 40 cm)	208220	\$1,795.00
BCE5201-1NUS	5200 g	0.1 g	0.1 g	4.7 in (120 mm)	20.67 × 19.49 × 15.75 in (52.5 × 49.5 × 40 cm)	208221	\$2,355.00
BCE6202-1NUS	6200 g	10 mg	0.1 g	4.7 in (120 mm)	20.67 × 19.49 × 15.75 in (52.5 × 49.5 × 40 cm)	208222	\$1,345.00

Options/Accessories

Part #	Model #	Description	Price
112261	YDP20-OCE	Data printer (printer requires power supply part number 191429)	\$1,330.00
31103	6906937	Paper rolls, one roll	\$38.00
31106	6906918	Ink ribbon cassette	\$43.00
201911	YCC-D09MF	Data Cable RS-232, DB-9M to DB-9F (For YDP20 Printer)	\$71.00
204042	YEPS01-PS8	Replacement AC adapter with interchangeable plugs (for use with Entris II)	\$55.00
191429	YEPS01-PS4	AC adapter with interchangeable plugs (for use with YDP20-OCE printer)	\$61.00



PRECISION CUBIS® II Series MCA

Standard Features

- Modular design
- User configurable and custom designed to meet changing applications
- Meets advanced Pharma compliance including user/password management for security, audit trail function logs and integrated alibi memory
- RS-232 and USB communication
- Easy cleaning by removing glass doors
- Underweigh hook included
- Manual glass draft shield
- Choice of display
- MCA - Large, high-end, 7 in color touch-screen TFT display in 16:9 format

OPTIONS

- Bluetooth® wireless technology

Specifications

Weighing Units

Milligram, Gram, Kilogram, Ounce, Pound, Carat, Pennyweight, Troy Ounce, Grain, Newton Pound/Ounce, Micrograms (See technical manual for complete listing)

Operating Modes

Mass Unit Conversion, SQ Min Function, ISO-Cal Function, Density Determination (Buoyancy method only with MSE), Calculation, Averaging, Formulation, Percent Weighing, Totalizing, Counting, Customized Identification, Statistics, Time Control Function, Second Tare Memory, Over/Under Checkweighing

Power

120 V AC adapter (auto ranging)

Stabilization Time

3203S, 2203S, 2203P, 1203S, 5203S, 5203P: 1 second
623S, 623P, 323S: 0.8 seconds

Calibration Weight

3203S, 2203S: 2,000 g
2203P, 1203S: 1,000 g
5203S, 5203P: 500 g
623S, 623P: 500 g
323S: 200 g

Operating Temperature

5° C to 40° C (41° F to 104° F)

Est. Weight

17 lb

Warranty

Two-year limited warranty

Return Policy

Sartorius Standard Policy - restock fee may apply

Model	Capacity	Readability	Repeatability	Linearity	Pan Size	Dimensions	Part #	List Price
MCA623P	150/300/620 g	1, 2, 5 mg	1/2/4 mg	5 mg	5.5 × 5.5 in (140 × 140 mm)	16 × 9.8 × 11 in (410 × 249 × 281.4 mm)	195811	\$6,485.00
MCA323S	320 g	1 mg	0.7 mg	2 mg	5.5 × 5.5 in (140 × 140 mm)	16 × 9.8 × 11 in (410 × 249 × 281.4 mm)	195716	\$6,365.00
MCA623S	620 g	1 mg	0.7 mg	2 mg	5.5 × 5.5 in (140 × 140 mm)	16 × 9.8 × 11 in (410 × 249 × 281.4 mm)	195715	\$7,250.00
MCA1203S	1,200 g	1 mg	0.7 mg	2 mg	5.5 × 5.5 in (140 × 140 mm)	16 × 9.8 × 11 in (410 × 249 × 281.4 mm)	195713	\$9,010.00
MCA2203P	1,010/2,200 g	1/10 mg	1/6 mg	5 mg	5.5 × 5.5 in (140 × 140 mm)	16 × 9.8 × 11 in (410 × 249 × 281.4 mm)	195809	\$9,840.00
MCA2203S	2,200 g	1 mg	1 mg	3 mg	5.5 × 5.5 in (140 × 140 mm)	16 × 9.8 × 11 in (410 × 249 × 281.4 mm)	195712	\$10,145.00
MCA3203S	3,200 g	1 mg	1/6 mg	5 mg	5.5 × 5.5 in (140 × 140 mm)	16 × 9.8 × 11 in (410 × 249 × 281.4 mm)	195711	\$9,630.00
MCA5203S	5,200 g	1 mg	1 mg	5 mg	5.5 × 5.5 in (140 × 140 mm)	16 × 9.8 × 11 in (410 × 249 × 281.4 mm)	195714	\$11,925.00
MCA5203P	5,200/2,400/ 1,200 g	5/2/1 mg	1 mg	5 mg	5.5 × 5.5 in (140 × 140 mm)	16 × 9.8 × 11 in (410 × 249 × 281.4 mm)	195810	\$11,410.00

Options/Accessories

Part#	Model#	Description	Price
Consult	TR	Certificate of compliance and full factory test report (factory installed)	Consult
Consult	IR	Additional RS-232, 25-pin connection (factory installed)	Consult
156906	6971987	Power supply, 100-240 V	\$210.00
156908	6900900	Cord, power 220 V EU	\$43.00
Consult	IB	Bluetooth® wireless interface (factory installed)	Consult
Consult	IP	Additional RS-232, 9-pin connection with PS2 port (factory installed)	Consult
Consult	DA, DR, DI or DU	Other draft shields available	Consult



PRECISION
CUBIS® II Series MCE

Standard Features

- Modular design
- User configurable and custom designed to meet changing applications
- Meets advanced Pharma compliance including user/password management for security, audit trail function logs and integrated alibi memory
- RS-232 and USB communication
- Easy cleaning by removing glass doors
- Underweigh hook included
- Manual glass draft shield
- Choice of display
- MCE - State-of-the-art, TFT touchscreen operation

OPTIONS

- Bluetooth® wireless technology

Specifications

Weighing Units

Milligram, Gram, Kilogram, Ounce, Pound, Carat, Pennyweight, Troy Ounce, Grain, Newton Pound/Ounce, Micrograms (See technical manual for complete listing)

Operating Modes

Mass Unit Conversion, SQ Min Function, ISO-Cal Function, Density Determination (Buoyancy method only with MSE), Calculation, Averaging, Formulation, Percent Weighing, Totalizing, Counting, Customized Identification, Statistics, Time Control Function, Second Tare Memory, Over/Under Checkweighing

Power

120 V AC adapter (auto ranging)

Stabilization Time

3203S, 2203S, 2203P, 1203S, 5203S, 5203P: 1 second
 623S, 623P, 323S: 0.8 seconds

Calibration Weight

3203S, 2203S: 2,000 g
 2203P, 1203S: 1,000 g
 5203S, 5203P: 500 g
 623S, 623P: 500 g
 323S: 200 g

Operating Temperature

5° C to 40° C (41° F to 104° F)

Est. Weight

17 lb

Warranty

Two-year limited warranty

Return Policy

Sartorius Standard Policy - restock fee may apply

Model	Capacity	Readability	Repeatability	Linearity	Pan Size	Dimensions	Part #	List Price
MCE323S	320 g	1 mg	0.7 mg	2 mg	5.5 × 5.5 in (140 × 140 mm)	16 × 9.8 × 11 in (410 × 249 × 281.4 mm)	195709	\$5,540.00
MCE623P	150/300/ 620 g	1, 2, 5 mg	1/2/4 mg	5 mg	5.5 × 5.5 in (140 × 140 mm)	16 × 9.8 × 11 in (410 × 249 × 281.4 mm)	195808	\$5,655.00
MCE623S	620 g	1 mg	0.7 mg	2 mg	5.5 × 5.5 in (140 × 140 mm)	16 × 9.8 × 11 in (410 × 249 × 281.4 mm)	195707	\$6,415.00
MCE5203P	5,200/2,400/ 1,200 g	5/2/1 mg	1 mg	5 mg	5.5 × 5.5 in (140 × 140 mm)	16 × 9.8 × 11 in (410 × 249 × 281.4 mm)	195807	\$10,575.00
MCE5203S	5,200 g	1 mg	1 mg	5 mg	5.5 × 5.5 in (140 × 140 mm)	16 × 9.8 × 11 in (410 × 249 × 281.4 mm)	195706	\$11,095.00
MCE1203S	1,200 g	1 mg	0.7 mg	2 mg	5.5 × 5.5 in (140 × 140 mm)	16 × 9.8 × 11 in (410 × 249 × 281.4 mm)	195705	\$8,175.00
MCE2203P	1,010/2,200 g	1/10 mg	1/6 mg	5 mg	5.5 × 5.5 in (140 × 140 mm)	16 × 9.8 × 11 in (410 × 249 × 281.4 mm)	195806	\$9,010.00
MCE2203S	2,200 g	1 mg	1 mg	3 mg	5.5 × 5.5 in (140 × 140 mm)	16 × 9.8 × 11 in (410 × 249 × 281.4 mm)	195704	\$9,315.00
MCE3203S	3,200 g	1 mg	1/6 mg	5 mg	5.5 × 5.5 in (140 × 140 mm)	16 × 9.8 × 11 in (410 × 249 × 281.4 mm)	195703	\$9,630.00

Options/Accessories

Part #	Model #	Description	Price
Consult	TR	Certificate of compliance and full factory test report (factory installed)	Consult
Consult	IR	Additional RS-232, 25-pin connection (factory installed)	Consult
156906	6971987	Power supply, 100-240 V	\$210.00
156908	6900900	Cord, power 220 V EU	\$43.00
Consult	IB	Bluetooth® wireless interface (factory installed)	Consult
Consult	IP	Additional RS-232, 9-pin connection with PS2 port (factory installed)	Consult
Consult	DA, DR, DI or DU	Other draft shields available	Consult

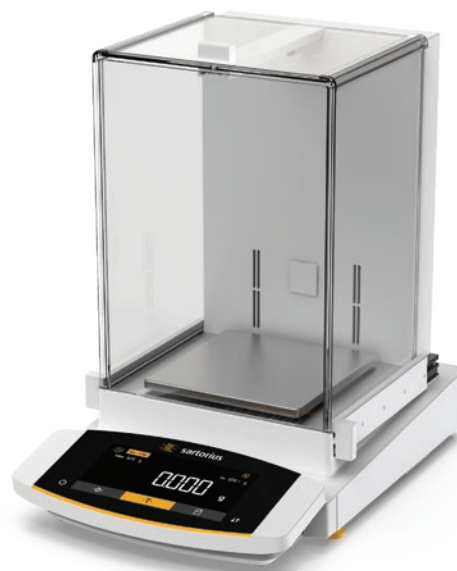

PRECISION

ENTRIS II Series Basic Essential

Standard Features

- Backlit LED Touchscreen
- User-friendly operation
- Basic applications
- Monolithic weighing systems
- Aluminum die-cast base, ABS housing
- Front level bubble
- RS-232
- Weigh below hook

Specifications

Weighing Units

Gram, Kilogram, Ounce, Pound, Carat, Pennyweight, Troy Ounce, Grain, Newton (See technical manual for complete listing)

Operating Modes

Weighing, Density, Percentage, Counting, Mass Unit Conversion

Power

AC adapter, 115 V-240 V, US plug

Stabilization Time

BCE223I-1S: 1.3 seconds
 BCE323I-1S: 1.1 seconds
 BCE423I-1S, BCE623I-1S, BCE622I-1S: 1.0 seconds
 BCE653I-1S: 1.5 seconds

Operating Humidity

15% to 80% for temperatures up to 31° C

Calibration Weight

BCE223I-1S, BCE323I-1S, BCE423I-1S: 200 g
 BCE623I-1S, BCE653I-1S: 500 g

Operating Temperature

5° C to 40° C (41° F to 104° F)

Est. Weight

13.7 lb (6.2 kg)

Warranty

Two-year limited warranty

Model	Capacity	Readability	Repeatability	Linearity	Pan Size	Dimensions	Part #	List Price
BCE223I-1S	220 g	0.001 g	±1mg	±2mg	4.7 in (120mm)	9.1 × 11.9 × 5.4 in (230 × 303 × 136mm)	197395	\$1,565.00
BCE323I-1S	320 g	0.001 g	±1mg	±2mg	4.7 in (120mm)	9.1 × 11.9 × 5.4 in (230 × 303 × 136mm)	197396	\$1,795.00
BCE423I-1S	420 g	0.001 g	±1mg	±2mg	4.7 in (120mm)	9.1 × 11.9 × 5.4 in (230 × 303 × 136mm)	197397	\$2,235.00
BCE623I-1S	620 g	0.001 g	±1mg	±2mg	4.7 in (120mm)	9.1 × 11.9 × 5.4 in (230 × 303 × 136mm)	197398	\$2,465.00
BCE653I-1S	650 g	0.001 g	±1mg	±2mg	4.7 in (120mm)	9.1 × 11.9 × 3.4 in (230 × 303 × 87mm)	197400	\$2,685.00

Options/Accessories

Part #	Model #	Description	Price
112261	YDP20-OCE	Data printer (printer requires power supply part number 191429)	\$1,330.00
31103	6906937	Paper rolls, one roll	\$38.00
31106	6906918	Ink ribbon cassette	\$43.00
201911	YCC-D09MF	Data Cable RS-232, DB-9M to DB-9F (For YDP20 Printer)	\$71.00
204042	YEPS01-PS8	Replacement AC adapter with interchangeable plugs (for use with Entris II)	\$55.00
191429	YEPS01-PS4	AC adapter with interchangeable plugs (for use with YDP20-OCE printer)	\$61.00



PRECISION
ENTRIS II Series Basic Advanced

Standard Features

- User-friendly operation
- Basic applications
- Monolithic weighing systems
- Aluminum die-cast base, ABS housing
- Front level bubble
- RS-232 standard
- Below balance weighing

Specifications

Weighing Units

Gram, Kilogram, Ounce, Pound, Carat, Pennyweight, Troy Ounce, Grain, Newton (See technical manual for complete listing)

Operating Modes

Weighing, Density, Percentage, Counting, Mass Unit Conversion, Mixing, Statistics, Components, Animal Weighing, Checkweighing, Peak Hold and Pipette Test

Power

AC adapter, 115 V-240 V, US plug

Stabilization Time

BCA223I-1S: 2.5 seconds
 BCA323I-1S: 1.1 seconds
 BCA423I-1S, BCA623I-1S: 1.0 seconds
 BCA1203I-1S: 1.5 seconds

Operating Humidity

15% to 80% for temperatures up to 31° C

Calibration Weight

BCA223I-1S, BCA323I-1S: 200 g
 BCA423I-1S, BCA623I-1S, BCA1203I-1S: 500 g

Operating Temperature

5° C to 40° C (41° F to 104° F)

Est. Weight

BCA223I-1S, BCA323I-1S,
 BCA423I-1S: 13.7 lb (6.2 kg)
 BCA623I-1S: 13.9 lb (6.3 kg)
 BCA1203I-1S: 12 lb (5.4 kg)

Warranty

Two-year limited warranty

Model	Capacity	Readability	Repeatability	Linearity	Pan Size	Dimensions	Part #	List Price
BCA223I-1S	220 g	1 mg	±0.1 mg	±0.2 mg	3.5 in (90 mm)	20.67 × 19.49 × 15.75 in (52.5 × 49.5 × 40 cm)	202470	\$2,285.00
BCA323I-1S	320 g	1 mg	±1 mg	±2 mg	4.7 in (120 mm)	20.67 × 19.49 × 15.75 in (52.5 × 49.5 × 40 cm)	202472	\$2,500.00
BCA423I-1S	420 g	1 mg	±1 mg	±2 mg	4.7 in (120 mm)	20.67 × 19.49 × 15.75 in (52.5 × 49.5 × 40 cm)	202474	\$2,715.00
BCA623I-1S	620 g	1 mg	±1 mg	±2 mg	4.7 in (120 mm)	20.67 × 19.49 × 15.75 in (52.5 × 49.5 × 40 cm)	202475	\$3,260.00
BCA1203I-1S	1,200 g	1 mg	±1 mg	±2 mg	4.7 in (120 mm)	20.67 × 19.49 × 15.75 in (52.5 × 49.5 × 40 cm)	202478	\$4,345.00

Options/Accessories

Part #	Model #	Description	Price
112261	YDP20-OCE	Data printer (printer requires power supply part number 191429)	\$1,330.00
31103	6906937	Paper rolls, one roll	\$38.00
31106	6906918	Ink ribbon cassette	\$43.00
201911	YCC-D09MF	Data Cable RS-232, DB-9M to DB-9F (For YDP20 Printer)	\$71.00
204042	YEPS01-PS8	Replacement AC adapter with interchangeable plugs (for use with Entris II)	\$55.00
191429	YEPS01-PS4	AC adapter with interchangeable plugs (for use with YDP20-OCE printer)	\$61.00



PRECISION

PRACTUM / QUINTIX / SECURA Series

Standard Features

- Simple, color capacitive touch with swipe technology
- Monolithic and strain gauge technology
- Aluminum die-cast base, ABS housing
- Front level bubble
- Mini-USB
- Weigh below hook

QUINTIX AND SECURA OPTIONS

- isoCAL/fully automatic, external calibration
- GLP conformance with built-in time and date

SECURA OPTIONS

- Internal calibration
- Opto-electronic leveling system
- Sqmin safety program
- RS-232 interface cable

Specifications**Operating Modes**

Mass Unit Conversion, Counting,
Percent Weighing, Averaging

Weighing Units

Gram, Kilogram, Carat, Pound, Ounce, Troy Ounce,
Hong Kong Tael, Singapore Tael, Taiwan Tael, Grain,
Pennyweights, Milligram, Parts per Pound, China
Teal, Mommes, Austrian Carat, Tola, Baht, Mesghal
and Newton

Power Requirements

AC adapter, 115-240 VAC

Frequency

50-60 Hz

Display Type

LCD

External Calibration Weight

PRACTUM/ QUINTIX/ SECURA213-1S: 200 g
PRACTUM/ QUINTIX/ SECURA313-1S: 200 g
QUINTIX/ SECURA513-1S: 500 g

Operating Temperature

10° C to 30° C (50° F to 86° F)

Stabilization Time (typical)

3 seconds

Operating Humidity

Less than 95% RH

Est.Weight

4.5 kg (11 lb)

Model	Capacity	Readability	Repeatability	Linearity	Pan Size	Weighing Chamber	Dimensions	Part #	List Price
Practum									
PRACTUM213-1S	210 g	0.001 g	0.001 g	3 mg	120 mm (4.75 in)	209 mm (7.9 in)	360 × 216 × 320 mm (14.1 × 8.5 × 12.6 in)	153985	\$1,590.00
PRACTUM313-1S	310 g	0.001 g	0.001 g	3 mg	120 mm (4.75 in)	209 mm (7.9 in)	360 × 216 × 320 mm (14.1 × 8.5 × 12.6 in)	153986	\$1,710.00
Quintix									
QUINTIX213-1S	210 g	0.001 g	0.001 g	2 mg	120 mm (4.75 in)	209 mm (7.9 in)	360 × 216 × 320 mm (14.1 × 8.5 × 12.6 in)	153994	\$2,305.00
QUINTIX313-1S	310 g	0.001 g	0.001 g	2 mg	120 mm (4.75 in)	209 mm (7.9 in)	360 × 216 × 320 mm (14.1 × 8.5 × 12.6 in)	153995	\$2,465.00
QUINTIX513-1S	510 g	0.001 g	0.001 g	2 mg	120 mm (4.75 in)	209 mm (7.9 in)	360 × 216 × 320 mm (14.1 × 8.5 × 12.6 in)	153996	\$3,335.00
Secura									
SECURA213-1S	210 g	0.001 g	0.001 g	2 mg	120 mm (4.75 in)	209 mm (7.9 in)	360 × 216 × 320 mm (14.1 × 8.5 × 12.6 in)	154007	\$2,645.00
SECURA313-1S	310 g	0.001 g	0.001 g	2 mg	120 mm (4.75 in)	209 mm (7.9 in)	360 × 216 × 320 mm (14.1 × 8.5 × 12.6 in)	154008	\$2,875.00
SECURA513-1S	510 g	0.001 g	0.001 g	2 mg	120 mm (4.75 in)	209 mm (7.9 in)	360 × 216 × 320 mm (14.1 × 8.5 × 12.6 in)	154009	\$3,600.00

Options/Accessories

Part #	Model #	Description	Price
191429	6971790	AC adapter, 110-240 V, six power plugs	\$61.00
155847	YCC03-D09	Adapter cable, USB to RS-232	\$64.00



Standard Features

- Simple, color capacitive touch with swipe technology
- Monolithic and strain gauge technology
- Aluminum die-cast base, ABS housing
- Front level bubble
- Mini-USB
- Weigh below hook

QUINTIX AND SECURA OPTIONS

- isoCAL/fully automatic, external calibration
- GLP conformance with built-in time and date

SECURA OPTIONS

- Internal calibration
- Opto-electronic leveling system
- Sqmin safety program
- Legal for Trade models available

Specifications

Operating Modes

Mass Unit Conversion, Counting, Percent Weighing, Averaging

Weighing Units

Gram, Kilogram, Carat, Pound, Ounce, Troy Ounce, Hong Kong Tael, Singapore Tael, Taiwan Tael, Grain, Pennyweights, Milligram, Parts per Pound, China Teal, Mommies, Austrian Carat, Tola, Baht, Mesghal and Newton

Display Type

LCD

AC Power Requirements

AC adapter, 115 V-240 V

Frequency

50-60 Hz

External Calibration Weight

612-1S: 500 g
1102-1S: 1,000 g
2102-1S: 2,000 g
5101-1S, 5100-1S: 5,000 g

Stabilization Time (typical)

3 seconds

Operating Humidity

Less than 95% RH

Operating Temperature

10° C to 30° C (50° F to 86° F)

Est Weight

9 lb (4.5 kg)

Warranty

Two-year limited warranty

Model	Capacity	Readability	Repeatability	Linearity	Pan Size	Dimensions	Part #	List Price
Practum								
PRACTUM612-1S	610 g	0.01 g	±10 mg	±30 mg	7 in (180 mm)	14.1 × 8.5 × 12.6 in (360 × 216 × 320 mm)	153987	\$1,250.00
PRACTUM1102-1S	1,100 g	0.01 g	±10 mg	±30 mg	7 in (180 mm)	14.1 × 8.5 × 12.6 in (360 × 216 × 320 mm)	153988	\$1,380.00
PRACTUM2102-1S	2,100 g	0.01 g	±10 mg	±30 mg	7 in (180 mm)	14.1 × 8.5 × 12.6 in (360 × 216 × 320 mm)	153989	\$1,440.00
PRACTUM5101-1S	5,100 g	0.1 g	0.1 g	±0.3 g	7 in (180 mm)	14.1 × 8.5 × 12.6 in (360 × 216 × 320 mm)	153991	\$1,470.00
PRACTUM5100-1S	5,100 g	1.0 g	1.0 g	±3.0 g	7 in (180 mm)	14.1 × 8.5 × 12.6 in (360 × 216 × 320 mm)	153990	\$1,135.00
Quintix								
QUINTIX612-1S	610 g	0.01 g	±10 mg	±20 mg	7 in (180 mm)	14.1 × 8.5 × 12.6 in (360 × 216 × 320 mm)	153998	\$1,945.00
QUINTIX1102-1S	1,100 g	0.01 g	±10 mg	±20 mg	7 in (180 mm)	14.1 × 8.5 × 12.6 in (360 × 216 × 320 mm)	153999	\$2,205.00
QUINTIX2102-1S	2,100 g	0.01 g	±10 mg	±20 mg	7 in (180 mm)	14.1 × 8.5 × 12.6 in (360 × 216 × 320 mm)	154000	\$2,465.00
QUINTIX3102-1S	3,100 g	0.01 g	±10 mg	±20 mg	7 in (180 mm)	14.1 × 8.5 × 12.6 in (360 × 216 × 320 mm)	154001	\$2,725.00
QUINTIX5102-1S	5,100 g	0.01 g	±10 mg	±20 mg	7 in (180 mm)	14.1 × 8.5 × 12.6 in (360 × 216 × 320 mm)	154003	\$3,380.00
QUINTIX5101-1S	5,100 g	0.1 g	0.1 g	±0.2 g	7 in (180 mm)	14.1 × 8.5 × 12.6 in (360 × 216 × 320 mm)	154004	\$1,945.00
QUINTIX5100-1S	5,100 g	1.0 g	1.0 g	±0.2 g	7 in (180 mm)	14.1 × 8.5 × 12.6 in (360 × 216 × 320 mm)	154002	\$1,560.00
Secura								
SECURA1102-1S	1,100 g	0.01 g	±10 mg	±20 mg	0 7 in (180 mm)	8.58 × 14.17 × 3.70 in (218 × 360 × 94 mm)	154010	\$2,515.00
SECURA2102-1S	2,100 g	0.01 g	±10 mg	±20 mg	0 7 in (180 mm)	8.58 × 14.17 × 3.70 in (218 × 360 × 94 mm)	154011	\$2,995.00
SECURA3102-1S	3,100 g	0.01 g	±10 mg	±20 mg	0 7 in (180 mm)	8.58 × 14.17 × 3.70 in (218 × 360 × 94 mm)	154012	\$3,240.00
SECURA5102-1S	5,100 g	0.01 g	±10 mg	±20 mg	0 7 in (180 mm)	8.58 × 14.17 × 3.70 in (218 × 360 × 94 mm)	154013	\$3,725.00

Options/Accessories

Part #	Model #	Description	Price
191429	6971790	AC adapter, 110-240 V, six power plugs	\$61.00
155847	YCC03-D09	Adapter cable, USB to RS-232	\$64.00



TOPLOADER CUBIS® II Series MCA

Standard Features

- Fast stabilization time
- Modular design
- User configurable and custom designed to meet changing applications
- Meets advanced Pharma compliance including user/password management for security, audit trail function logs and integrated alibi memory
- RS-232 and USB communication
- Underweigh hook included
- Choice of display
- MCA - Large, high-end, 7in color touch-screen TFT display in 16:9 format

OPTIONS

- Bluetooth® wireless technology

Specifications

Weighing Units

Milligram, Gram, Kilogram, Ounce, Pound, Carat, Pennyweight, Troy Ounce, Grain, Newton Pound/Ounce, Micrograms (See technical manual for complete listing)

Operating Modes

Mass Unit Conversion, SQ Min Function, ISO-Cal Function, Density Determination (Buoyancy method only with MSE), Calculation, Averaging, Formulation, Percent Weighing, Totalizing, Counting, Customized Identification, Statistics, Time Control Function, Second Tare Memory

Power

120 V AC adapter (auto ranging)

Stabilization Time

1202S, 2202S, 4202S, 5201S, 8201S, 12201S: 0.8 seconds
6202P, 6202S, 8202S, 10202S, 5202S, 14202S, 14202P: 1 second

Calibration Weight

1202S: 1 kg
2202S, 4202S: 2 kg
6202S, 8202S, 5201S, 8201S: 5 kg
5202S: 5,000 g
10202S, 12201S, 14202S, 14202P: 10 kg

Operating Temperature

5°C to 40°C (41°F to 104°F)

Est. Weight

21 lb

Warranty

Two-year limited warranty

Return Policy

Sartorius Standard Policy - restock fee may apply

Model	Capacity	Readability	Repeatability	Linearity	Pan Size	Dimensions	Part #	List Price
MCA1202S	1,200 g	10 mg	7 mg	20 mg	8.1 × 8.1 in (206 × 206 mm)	16 × 9.8 × 3.5 in (410 × 249 × 87.7 mm)	195733	\$5,050.00
MCA2202S	2,200 g	10 mg	7 mg	20 mg	8.1 × 8.1 in (206 × 206 mm)	16 × 9.8 × 3.5 in (410 × 249 × 87.7 mm)	195732	\$5,500.00
MCA4202S	4,200 g	10 mg	7 mg	20 mg	8.1 × 8.1 in (206 × 206 mm)	16 × 9.8 × 3.5 in (410 × 249 × 87.7 mm)	195731	\$5,960.00
MCA5201S	5,200 g	100 mg	50 mg	100 mg	8.1 × 8.1 in (206 × 206 mm)	16 × 9.8 × 3.5 in (410 × 249 × 87.7 mm)	195736	\$4,335.00
MCA5202s	5,200 g	0.01 g	0.006 g	0.01 g	8.1 × 8.1 in (206 × 206 mm)	16 × 9.8 × 3.5 in (410 × 249 × 87.7 mm)	195820	\$7,320.00
MCA6202P	1,500 g/3,000 g/ 6,200 g	10 mg/20 mg/ 50 mg	7 mg/20 mg/ 1940 mg	20 mg	8.1 × 8.1 in (206 × 206 mm)	16 × 9.8 × 3.5 in (410 × 249 × 87.7 mm)	195818	\$6,135.00
MCA6202S	6,200 g	10 mg	7 mg	20 mg	8.1 × 8.1 in (206 × 206 mm)	16 × 9.8 × 3.5 in (410 × 249 × 87.7 mm)	195730	\$6,745.00
MCA8201S	8,200 g	100 mg	50 mg	100 mg	8.1 × 8.1 in (206 × 206 mm)	16 × 9.8 × 3.5 in (410 × 249 × 87.7 mm)	195735	\$5,575.00
MCA8202S	8,200 g	10 mg	7 mg	20 mg	8.1 × 8.1 in (206 × 206 mm)	16 × 9.8 × 3.5 in (410 × 249 × 87.7 mm)	195729	\$7,510.00
MCA10202S	10,200 g	10 mg	7 mg	20 mg	8.1 × 8.1 in (206 × 206 mm)	16 × 9.8 × 3.5 in (410 × 249 × 87.7 mm)	195728	\$8,555.00
MCA12201S	12,200 g	100 mg	50 mg	200 mg	8.1 × 8.1 in (206 × 206 mm)	16 × 9.8 × 3.5 in (410 × 249 × 87.7 mm)	195734	\$6,075.00
MCA14202S	14,200 g	0.01 g	0.01 g	0.03 g	8.1 × 8.1 in (206 × 206 mm)	16 × 9.8 × 3.5 in (410 × 249 × 87.7 mm)	195727	\$10,315.00
MCA14202P	3,500 g/7,000 g/ 14,200 g	0.01 g/0.02 g/ 0.05 g	0.05 g	0.05 g	8.1 × 8.1 in (206 × 206 mm)	16 × 9.8 × 3.5 in (410 × 249 × 87.7 mm)	195817	\$9,020.00

Options/Accessories

Part #	Model #	Description	Price
Consult	TR	Certificate of compliance and full factory test report (factory installed)	Consult
Consult	IR	Additional RS-232, 25-pin connection (factory installed)	Consult
156906	6971987	Power supply, 100-240 V	\$210.00
156908	6900900	Cord, power 220V EU	\$43.00
Consult	IB	Bluetooth® wireless interface (factory installed)	Consult
Consult	IP	Additional RS-232, 9-pin connection with PS2 port (factory installed)	Consult



Standard Features

- Fast stabilization time
- Modular design
- User configurable and custom designed to meet changing applications
- Meets advanced Pharma compliance including user/password management for security, audit trail function logs and integrated alibi memory
- RS-232 and USB communication
- Underweigh hook included
- Choice of display
- MCE - State-of-the-art, TFT touchscreen operation

OPTIONS

- Bluetooth® wireless technology

Specifications

Weighing Units

Milligram, Gram, Kilogram, Ounce, Pound, Carat, Pennyweight, Troy Ounce, Grain, Newton Pound/Ounce, Micrograms (See technical manual for complete listing)

Operating Modes

Mass Unit Conversion, SQ Min Function, ISO-Cal Function, Density Determination (Buoyancy method only with MSE), Calculation, Averaging, Formulation, Percent Weighing, Totalizing, Counting, Customized Identification, Statistics, Time Control Function, Second Tare Memory

Power

120 V AC adapter (auto ranging)

Stabilization Time

1202S, 2202S, 4202S, 5201S, 8201S, 12201S: 0.8 seconds
 6202P, 6202S, 8202S, 10202S, 5202S, 14202S, 14202P: 1 second

Calibration Weight

1202S: 1 kg
 2202S, 4202S: 2 kg
 5201S, 6202S, 8201S, 8202S: 5 kg
 5202S: 5,000 g
 10202S, 12201S, 14202S, 14202P: 10 kg

Operating Temperature

5°C to 40°C (41°F to 104°F)

Est. Weight

21 lb

Warranty

Two-year limited warranty

Return Policy

Sartorius Standard Policy - restock fee may apply

Model	Capacity	Readability	Repeatability	Linearity	Pan Size	Dimensions	Part #	List Price
MCE1202S	1,200 g	10 mg	7 mg	20 mg	8.1 × 8.1 in (206 × 206 mm)	16 × 9.8 × 3.5 in (410 × 249 × 87.7 mm)	195723	\$4,215.00
MCE2202S	2,200 g	10 mg	7 mg	20 mg	8.1 × 8.1 in (206 × 206 mm)	16 × 9.8 × 3.5 in (410 × 249 × 87.7 mm)	195722	\$4,675.00
MCE4202S	4,200 g	10 mg	7 mg	20 mg	8.1 × 8.1 in (206 × 206 mm)	16 × 9.8 × 3.5 in (410 × 249 × 87.7 mm)	195721	\$5,135.00
MCE5201S	5,200 g	100 mg	50 mg	100 mg	8.1 × 8.1 in (206 × 206mm)	16 × 9.8 × 3.5 in (410 × 249 × 87.7mm)	195726	\$3,505.00
MCE5202S	5,200 g	0.01 g	0.006 g	0.01 g	8.1 × 8.1 in (206 × 206mm)	16 × 9.8 × 3.5 in (410 × 249 × 87.7mm)	195816	\$6,490.00
MCE6202P	1,500 g/3,000 g/ 6,200 g	10 mg/20 mg/ 50 mg	7 mg/20 mg/ 1940 mg	20 mg	8.1 × 8.1 in (206 × 206 mm)	16 × 9.8 × 3.5 in (410 × 249 × 87.7 mm)	195815	\$5,305.00
MCE6202S	6,200 g	10 mg	7 mg	20 mg	8.1 × 8.1 in (206 × 206 mm)	16 × 9.8 × 3.5 in (410 × 249 × 87.7 mm)	195720	\$5,915.00
MCE8201S	8,200 g	100 mg	50 mg	100 mg	8.1 × 8.1 in (206 × 206mm)	16 × 9.8 × 3.5 in (410 × 249 × 87.7mm)	195725	\$4,740.00
MCE8202S	8,200 g	10 mg	7 mg	20 mg	8.1 × 8.1 in (206 × 206 mm)	16 × 9.8 × 3.5 in (410 × 249 × 87.7 mm)	195719	\$6,680.00
MCE10202S	10,200 g	10 mg	7 mg	20 mg	8.1 × 8.1 in (206 × 206 mm)	16 × 9.8 × 3.5 in (410 × 249 × 87.7 mm)	195718	\$7,730.00
MCE12201S	12,200 g	100 mg	50 mg	200 mg	8.1 × 8.1 in (206 × 206mm)	16 × 9.8 × 3.5 in (410 × 249 × 87.7mm)	195724	\$5,245.00
MCE14202s	14,200 g	0.01 g	0.01 g	0.03 g	8.1 × 8.1 in (206 × 206mm)	16 × 9.8 × 3.5 in (410 × 249 × 87.7mm)	195717	\$9,485.00
MCE14202P	3,500 g/7,000 g/ 14,200 g	0.01 g / 0.02 g / 0.05 g	0.01 g / 0.02 g / 0.01 g	0.05 g	8.1 × 8.1 in (206 × 206mm)	16 × 9.8 × 3.5 in (410 × 249 × 87.7mm)	195812	\$8,185.00

Options/Accessories

Part#	Model#	Description	Price
Consult	TR	Certificate of compliance and full factory test report (factory installed)	Consult
Consult	IR	Additional RS-232, 25-pin connection (factory installed)	Consult
156906	6971987	Power supply, 100-240 V	\$210.00
156908	6900900	Cord, power 220V EU	\$43.00
Consult	IB	Bluetooth® wireless interface (factory installed)	Consult
Consult	IP	Additional RS-232, 9-pin connection with PS2 port (factory installed)	Consult



TOPLOADER

ENTRIS II Series Basic Essential

Standard Features

- Backlit LED Touchscreen
- User-friendly operation
- Basic applications
- Monolithic weighing systems
- Aluminum die-cast base, ABS housing
- Front level bubble
- RS-232
- Weigh below hook

Specifications

Weighing Units

Gram, Kilogram, Ounce, Pound, Carat, Pennyweight, Troy Ounce, Grain, Newton (See technical manual for complete listing)

Operating Modes

Weighing, Density, Percentage, Counting, Mass Unit Conversion

Power

AC adapter, 115 V-240 V, US plug

Stabilization Time

1.5 seconds

Operating Humidity

15% to 80% for temperatures up to 31° C

Operating Temperature

5° C to 40° C (41° F to 104° F)

Calibration Weight

BCE622I-1S, BCE822II-1S, BCE1202I-1S, BCE2202I-1S: 500 g
BCE2201I-1S: 2,000 g
BCE3202I-1S, BCE4202I-1S, BCE5201I-1S, BCE6202I-1S, BCE6200I-1S, BCE8201I-1S, BCE8200I-1S: 5,000 g

Est Weight

BCE822II-1: 10.6 lb (4.8 kg)
BCE1202I-1S: 12 lb (5.4 kg)
BCE622I-1S, BCE2202I-1S: 13.9 lb (6.3 kg)
BCE2201I-1S, BCE3202I-1S, BCE4202I-1S, BCE5201I-1S, BCE6202I-1S, BCE6200I-1S, BCE8201I-1S, BCE8200I-1S: 12 lb (5.4 kg)

Warranty

Two-year limited warranty

Return Policy

Sartorius Standard Policy - restock fee may apply

Model	Capacity	Readability	Repeatability	Linearity	Pan Size	Dimensions	Part #	List Price
BCE622I-1S	620 g	0.01 g	±1 mg	±2 mg	4.7 in (120 mm)	9.1 × 11.9 × 13 in (230 × 303 × 330 mm)	197399	\$1,450.00
BCE822II-1S	820 g	0.01 g	±1 mg	±2 mg	4.7 in (120 mm)	9.1 × 11.9 × 5.4 in (230 × 303 × 136 mm)	197401	\$1,565.00
BCE1202I-1S	1,200 g	0.01 g	±1 mg	±2 mg	4.7 in (120 mm)	9.1 × 11.9 × 5.4 in (230 × 303 × 136 mm)	197402	\$1,675.00
BCE2202I-1S	2,200 g	0.01 g	±1 mg	±2 mg	4.7 in (120 mm)	9.1 × 11.9 × 5.4 in (230 × 303 × 136 mm)	197403	\$1,795.00
BCE2201I-1S	2,200 g	0.1 g	±0.1 g	±0.3 g	4.7 in (120 mm)	9.1 × 11.9 × 5.4 in (230 × 303 × 136 mm)	197404	\$1,565.00
BCE3202I-1S	3,200 g	0.01 g	±0.1 g	±0.3 g	4.7 in (120 mm)	9.1 × 11.9 × 5.4 in (230 × 303 × 136 mm)	197405	\$1,905.00
BCE4202I-1S	4,200 g	0.01 g	±0.1 g	±0.3 g	7.1 × 7.1 × 3.6 in (180 × 180 × 91 mm)	9.1 × 11.9 × 5.4 in (230 × 303 × 136 mm)	197406	\$2,125.00
BCE5201I-1S	5,200 g	0.1 g	±0.1 g	±0.3 g	7.1 × 7.1 × 3.6 in (180 × 180 × 91 mm)	9.1 × 11.9 × 5.4 in (230 × 303 × 136 mm)	197407	\$1,675.00
BCE6202I-1S	6,200 g	0.01 g	±0.1 g	±0.3 g	7.1 × 7.1 × 3.6 in (180 × 180 × 91 mm)	9.1 × 11.9 × 5.4 in (230 × 303 × 136 mm)	197408	\$2,685.00
BCE6200I-1S	6,200 g	1.0 g	±0.1 g	±0.3 g	7.1 × 7.1 × 3.6 in (180 × 180 × 91 mm)	9.1 × 11.9 × 5.4 in (230 × 303 × 136 mm)	197409	\$1,565.00
BCE8201I-1S	8,200 g	0.1 g	±0.1 g	±0.3 g	7.1 × 7.1 × 3.6 in (180 × 180 × 91 mm)	9.1 × 11.9 × 5.4 in (230 × 303 × 136 mm)	197410	\$1,905.00
BCE8200I-1S	8,200 g	1.0 g	±0.1 g	±0.3 g	7.1 × 7.1 × 3.6 in (180 × 180 × 91 mm)	9.1 × 11.9 × 5.4 in (230 × 303 × 136 mm)	197411	\$1,675.00

Options/Accessories

Part #	Model #	Description	Price
112261	YDP20-OCE	Data printer (printer requires power supply part number 191429)	\$1,330.00
31103	6906937	Paper rolls, one roll	\$38.00
31106	6906918	Ink ribbon cassette	\$43.00
201911	YCC-D09MF	Data Cable RS-232, DB-9M to DB-9F (For YDP20 Printer)	\$71.00
204042	YEPS01-PS8	Replacement AC adapter with interchangeable plugs (for use with Entris II)	\$55.00
191429	YEPS01-PS4	AC adapter with interchangeable plugs (for use with YDP20-OCE printer)	\$61.00



TOPLOADER ENTRIS II Series Basic Advanced

Standard Features

- User-friendly operation
- Basic applications
- Monolithic weighing systems
- Aluminum die-cast base, ABS housing
- Front level bubble
- RS-232 standard
- Below balance weighing

Specifications

Weighing Units

Gram, Kilogram, Ounce, Pound, Carat, Penny-weight, Troy Ounce, Grain, Newton (See technical manual for complete listing)

Operating Modes

Weighing, Density, Percentage, Counting, Mass Unit Conversion, Mixing, Statistics, Components, Animal Weighing, Checkweighing, Peak Hold and Pipette Test

Power

AC adapter, 115 V-240 V, US plug

Stabilization Time (typical)

1.5 seconds

Operating Humidity

15% to 80% for temperatures up to 31° C

Calibration Weight

BCA8221-1S, BCA12021-1S, BCA22011-1S: 500 g
BCA22021-1S: 2,000 g
BCA32021-1S, BCA42021-1S, BCA52011-1S, BCA62021-1S, BCA82011-1S, BCA102011-1S, BCA122011-1S: 5,000 g

Operating Temperature

5° C to 40° C (41° F to 104° F)

Est. Weight

BCA8221-1S, BCA22011-1S, BCA22021-1S, BCA32021-1S, BCA42021-1S, BCA52011-1S, BCA62021-1S, BCA82011-1S, BCA102011-1S, BCA122011-1S: 13.9 lb (6.3 kg)
BCA12021-1S: 10.6 lb (4.8 kg)

Warranty

Two-year limited warranty

Return Policy

Sartorius Standard Policy - restock fee may apply

Model	Capacity	Readability	Repeatability	Linearity	Pan Size	Dimensions	Part #	List Price
BCA8221-1S	820 g	10 mg	±1 mg	±2 mg	4.7 in (120 mm)	17.72 × 9.84 × 13.78 in (45 × 25 × 35 cm)	202476	\$2,065.00
BCA12021-1S	1,200 g	10 mg	±1 mg	±2 mg	4.7 in (120 mm)	17.72 × 9.84 × 13.78 in (45 × 25 × 35 cm)	202477	\$2,285.00
BCA22011-1S	2,200 g	0.1 g	±1 mg	±2 mg	4.7 in (120 mm)	17.72 × 9.84 × 13.78 in (45 × 25 × 35 cm)	202479	\$1,955.00
BCA22021-1S	2,200 g	10 mg	±0.1 g	±0.3 g	4.7 in (120 mm)	17.72 × 9.84 × 13.78 in (45 × 25 × 35 cm)	202480	\$2,500.00
BCA32021-1S	3,200 g	10 mg	±0.1 g	±0.3 g	4.7 in (120 mm)	17.72 × 9.84 × 13.78 in (45 × 25 × 35 cm)	202481	\$2,715.00
BCA42021-1S	4,200 g	10 mg	±0.1 g	±0.3 g	7.1 × 7.1 × 3.6 in (180 × 180 × 91 mm)	17.72 × 9.84 × 13.78 in (45 × 25 × 35 cm)	202482	\$2,825.00
BCA52011-1S	5,200 g	0.1 g	±0.1 g	±0.3 g	7.1 × 7.1 × 3.6 in (180 × 180 × 91 mm)	17.72 × 9.84 × 13.78 in (45 × 25 × 35 cm)	202483	\$2,175.00
BCA62021-1S	6,200 g	10 mg	±0.1 g	±0.3 g	7.1 × 7.1 × 3.6 in (180 × 180 × 91 mm)	17.72 × 9.84 × 13.78 in (45 × 25 × 35 cm)	202484	\$3,915.00
BCA82011-1S	8,200 g	0.1 g	±0.1 g	±0.3 g	7.1 × 7.1 × 3.6 in (180 × 180 × 91 mm)	17.72 × 9.84 × 13.78 in (45 × 25 × 35 cm)	202485	\$2,605.00
BCA102011-1S	10,200 g	0.1 g	±0.1 g	±0.3 g	7.1 × 7.1 × 3.6 in (180 × 180 × 91 mm)	17.72 × 9.84 × 13.78 in (45 × 25 × 35 cm)	202486	\$3,915.00
BCA122011-1S	12,200 g	0.1 g	±0.1 g	±0.3 g	7.1 × 7.1 × 3.6 in (180 × 180 × 91 mm)	17.72 × 9.84 × 13.78 in (45 × 25 × 35 cm)	202487	\$4,130.00

Options/Accessories

Part #	Model #	Description	Price
112261	YDP20-OCE	Data printer (printer requires power supply part number 191429)	\$1,330.00
31103	6906937	Paper rolls, one roll	\$38.00
31106	6906918	Ink ribbon cassette	\$43.00
201911	YCC-D09MF	Data Cable RS-232, DB-9M to DB-9F (For YDP20 Printer)	\$71.00
204042	YEPS01-PS8	Replacement AC adapter with interchangeable plugs (for use with Entris II)	\$55.00
191429	YEPS01-PS4	AC adapter with interchangeable plugs (for use with YDP20-OCE printer)	\$61.00



MOISTURE ANALYZER

MA35, MA37 and MA160 Series

Standard Features

- High-speed measurements
- Effortless cleaning
- User-friendly operation
- Display of process status

Specifications**Heating Element**

MA35, MA37: Infrared metal heating element
 MA160: Infrared radiation by an AURI heater, 600 W

Heating Mode

MA35, MA37: Standard drying
 MA160: Standard drying, gentle drying

Power

120/230 VAC multi-range adapter

Display Modes for Results

Moisture content in % M and g; dry matter in % S
 and g; ATRO in % M/S

Data Interface

MA35: RS-232
 MA37: Mini USB
 MA160: M-Mini USB

Calibration Weight

MA35: 30 g
 MA37: 50 g
 MA160: 200 g

Operating Temperature

10° C to 30° C (50° F to 86° F)

Temperature Range and Settings

40° C to 160° C (104° F to 320° F)

Est. Weight

MA35: 12.8 lb (5.8 kg)
 MA37, MA160: 13.7 lb (6.2 kg)

Warranty

Two-year limited warranty

Return Policy

Sartorius Standard Policy - restock fee may apply

Model	Capacity	Readability	Repeatability	Pan Size	Dimensions	Part #	List Price
MA35	35 g	0.001 g	For initial sample weight approx $>1 \pm 0.2\%$; for initial sample weight $>5 \pm 0.05\%$	90 mm	8.8 × 14.4 × 7.5in (224 × 366 × 191 mm)	191983	\$2,780.00
MA37	70 g	0.001 g	For initial sample weight approx $>1 \pm 0.2\%$; for initial sample weight $>5 \pm 0.05\%$	90 mm	8.5 × 15.7 × 8.3in (215 × 400 × 210 mm)	165963	\$3,900.00
MA160	200 g	0.01 g	For initial sample weight approx $>1 \pm 0.2\%$; for initial sample weight $>5 \pm 0.05\%$	90 mm	8.5 × 15.7 × 8.3in (215 × 400 × 210 mm)	165964	\$4,920.00



Standard Features

- Converts serial data such as bar code reader or scale into keyboard input to software program
- Works with PC and MAC® computers
- Requires no driver installation (identifies itself as additional HID keyboard)
- Cable draws power from USB port (no external power supply needed)
- Test cable to be connected with adaptor scale cable or connector
- Bluetooth® version allows Bluetooth® connection to devices like iPad®, Playbook, Android® tablets and smart phones

Specifications

Baud Rate
9600

Color
Black

Cable Length
74 in (1880 mm)

Bluetooth Cable Length
16 in (406 mm)

Power
USB power, no external power supply

Host
PC and MAC® compliant

Connection
DB9 male connector, Pin 2 RX, Pin 3 TX and Pin 5 Ground
USB A connector

Part Number/Price

Part #	Description	Weight	Price
119919	RS-232/USB serial cable	1lb	\$190.00
132452	RS-232/USB serial cable plus Bluetooth®	1lb	\$275.00

Options/Accessories

Part #	Description	Price
119064	Slimline null modem, gender changer DB9 female to female	\$11.00
22436	Blunt-end to DB9 female, straight cable	\$67.00
50749	DB9 female to DB9 female	\$60.00
130789	Null model DB9 adapter female to male	\$13.00



DATA CAPTURE AND STORAGE GO-BETWEEN™

Standard Features

- LED onboard for testing data transmission
- Captures data and stores it on a USB flash drive (up to 8 GB not included)
- Transfer data to your PC using the USB flash drive
- Text file examples (actual text will be dependent on transmitted file)

02:50PM
11/13/2012
GROSS 58 lb
02:50PM
11/13/2012
GROSS 68 lb

Specifications

Baud Rate

9600

Data Bits

8

Parity

None

Power

Requires 5 VDC

Customer Supplied

Power and USB flash drive

Industrial Enclosure Option

7.5 × 7.5 × 4.5 in (19 × 19 × 12 cm)

Latch for lock

Warranty

One-year limited warranty

Part Number/Price

Part #	Description	Price
153265	go-between board, requires 5 Volts	\$435.00
153266	go-between industrial enclosure, requires 5 Volts	\$630.00
153267	go-between desk enclosure, power supply included	\$525.00

Options/Accessories

Part #	Description	Price
154797	Adapter, power 5 VDC 2A 90-264 VAC, U.S. plug, UL/CUL	\$37.00
195607	USB flash drive, 8 GB	\$7.00
130789	Null model DB9 adapter female to male	\$13.00
119064	Null modem adapter, DB9 F/F	\$11.00
50764	Straight cable, DB9 F/F	\$69.00
66535	Null modem DB9 F/F	\$46.00
22436	DB9 cable to blunt end	\$67.00
15493	Cable four-conductor	\$1.55/ft



KASOTA STONE BALANCE SLAB

Standard Features

- Balance slabs
- Balance tables
- Anti-vibration



Reduces vibration and shock, ideal where tables will not fit.

Part Number/Price

Part #	Description	Price
Standard Balance Slab, Kasota Stone		
83779	15 in × 20 in × 3 in, 100 lb	\$475.00

KASOTA STONE BALANCE TABLE

Standard Features

- Balance slabs
- Balance tables
- Anti-vibration



Provides the most stable surface possible for precision instruments. Legs are reinforced with support pipe.

Part Number/Price

Part #	Description	Price
Standard Balance Table, Kasota Stone		
83778	24 in × 35 in × 32 in, 700 lb	\$1,260.00

GRANITE CLEAN ROOM TABLE

Standard Features

- Balance slabs
- Balance tables
- Anti-vibration



Mass, density and vibration damping properties for most applications (four damping pads included).

Part Number/Price

Part #	Description	Price
Clean Room Table, Granite		
83780	24 in × 35 in × 32 in, 600 lb	\$2,850.00

ANTI-VIBRATION PAD

Standard Features

- Balance slabs
- Balance tables
- Anti-vibration

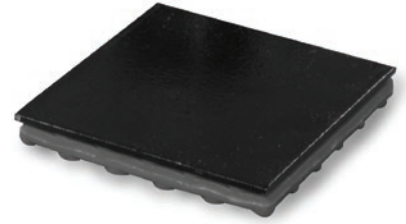

Part Number/Price

Part #	Description	Price
Anti-Vibration Pad		
75263	Anti-vibration pad 4 × 4 1/2 in-thick	\$15.75

SCOOPS

Standard Features

- Aluminum
- Polypropylene
- Stainless steel



PN 33447

Part Number/Price

Part #	Description	Price
33455	Aluminum, 1.5 × 2.0 in (3.8 × 5.1 cm)	\$44.00
33446	Polypropylene, 12 × 6 × 2.75 in (304 × 152 × 70 mm)	\$89.00
33447	Stainless steel, 12 × 6 × 2.75 in (304 × 152 × 70 mm)	\$157.00
33448	Polypropylene Maxi-scoop, 10 in (254 mm) diameter × 2.5 in (70 mm) deep with pouring spout	\$142.00
33454	Black, aluminum 4.0 × 3.5 in (10.2 × 8.9 cm)	\$45.00
33451	Polypropylene Maxi-scoop	\$44.00
97250	Stainless steel scoop 11.9 × 7.4 × 1.7 in	\$89.00
100292	Stainless steel scoop 17.2 × 11 × 3.4 in	\$105.00



PN 33455



PN 33451



PN 33454

STATIC BRUSHES, IONIZING STRIPS AND ACCESSORIES

STATIC CONTROL

NRD is the industry leader for providing advanced ionization products to eliminate electrostatic discharge and static attraction. The success of NRD devices is based on unique and extremely effective ionization sources that use alpha-energy to neutralize static electricity. Unlike electrical ionization systems, NRD ion sources don't just control static, they eliminate it by providing a constant balance of \pm zero volts.

The ion sources are entirely self-powered and never require any calibration or adjustment; therefore, there are no operating costs associated with them throughout their lifetime. Because NRD ion sources do not require electricity and are completely safe, they are ideal for use in any application, including highly-volatile environments.

Static charge buildup is the cause of many production problems including downtime, reduced product quality, and ultimately increased costs and reduced profits. Although the static charges cannot be seen, they are quite noticeable.

Thousands of volts of electricity can easily accumulate on the surfaces of in-process materials. This buildup can ignite combustibles, shock personnel, destroy sensitive electronic components and cause many types of production problems. In addition, static attraction of dirt, dust, and other foreign matter contaminates products and process equipment, which intensifies processing problems.

NRD alpha-energy devices rapidly neutralize charged materials. This is accomplished by emitting a flood of both

positively and negatively charged ions in the vicinity of the affected material. The charged material then attracts a sufficient quantity of oppositely charged ions to completely eliminate its static charge.

NRD alpha-energy ion sources totally eliminate static buildup, not just reduce it, as with other methods of static control. As with all types of ion sources, ionized air has absolutely no adverse effects on personnel.



1in Static Brush

3in Static Brush

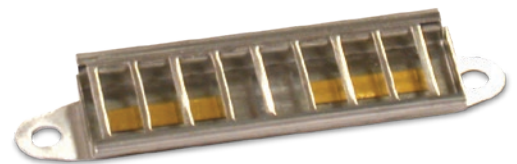

1in x 3in Ionizing Strip



1in x 1in Ionizing Strip



Stand Ionizer

STATIC BRUSHES, IONIZING STRIPS AND ACCESSORIES

STATIC CONTROL

Ionizers

Part #	Staticmaster Part #	Description	Price
164648	4068	Mini-fan ionizer	\$140.00
164649	6105	I-beam stand ionizer	\$1,070.00

Static Brushes - 1 inch

Part #	Staticmaster Part #	Description	Price
76669	1C200	Static brush, 1 in	\$140.00
76670	1C200R	Replacement cartridge	\$90.00

Static Brushes - 3 inch

Part #	Staticmaster Part #	Description	Price
76671	3C500	Static brush, 3 in	\$210.00
76672	3C500R	Replacement cartridge	\$145.00

Ionizing Strips - 1 inch

Part #	Staticmaster Part #	Description	Price
76677	1U400	Ionizing unit 1 in	\$145.00
76678	1U200	Ionizing unit 1 in	\$90.00

Ionizing Strips - 3 inch

Part #	Staticmaster Part #	Description	Price
76676	2U500	Ionizing unit 1 in × 3 in	\$134.00

Ionizing Strip Accessories

Part #	Staticmaster Part #	Description	Price
76679	BF1	Ionizer positioner	\$73.00
76680	BF2	Ionizer positioner only - C bracket	\$105.00
163601	BF3	EZ-Mount, 2U500 BF3 option mounts 2U500 to balance chamber	\$15.75
163602	5060	Grounding kit, 2U500 5060 enhances static eliminating power Staticmaster 2U500	\$31.50



Mini-fan Ionizer

2 GREAT LOCATIONS

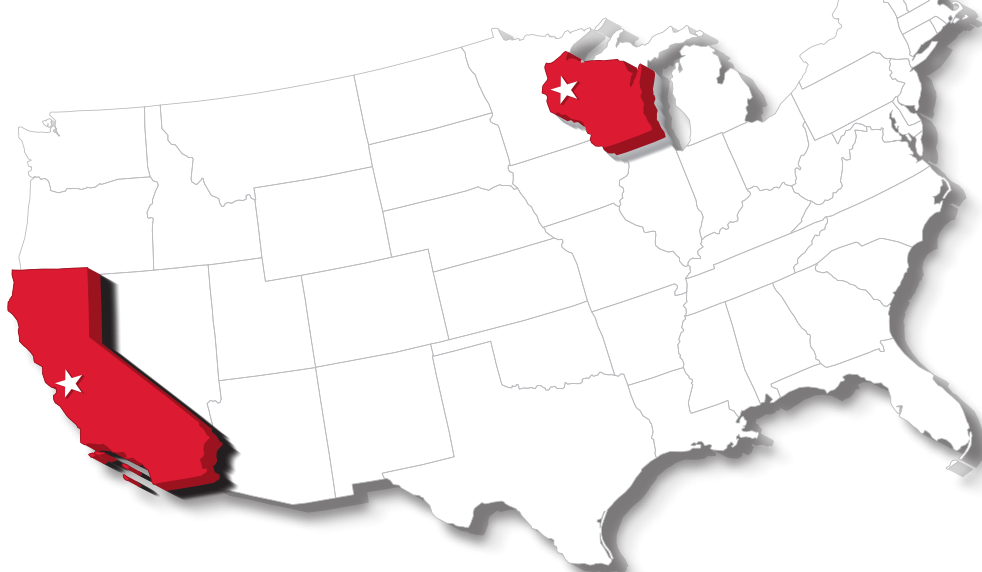

Same Great Service

Our metrology labs in Rice Lake, WI and Concord, CA both calibrate any brand of precision or industrial weight with a four-day turnaround.

Both labs are ISO/IEC 17025 accredited for their measurement capabilities. Accreditation brings an unbiased, third party evaluation of our measurement and technical capabilities ensuring you receive the most accurate and reliable calibration results.

To learn more about our metrology labs and request a calibration, visit www.ricelake.com/calibration



A2LA Cert. No. 4363.01
A2LA Cert. No. 1823.01



CALIBRATION
NVLAP Lab Code 105001-0
NVLAP Lab Code 600169-0

RICE LAKE[®]
WEIGHING SYSTEMS

800-472-6703

www.ricelake.com/calibration

1 MISSION

Provide reliable calibration services

2 ACCREDITED LABS

Ready to serve

3 TYPES

Of documentation available

4 DAYS

To calibrate any weight from any brand

RICE LAKE[®]
WEIGHING SYSTEMS

CORPORATE OFFICE

230 W. Coleman Street, Rice Lake, WI 54868 USA
USA: 800-472-6703 | Direct: 715-234-9171 | Fax: 715-234-6967
Canada and Mexico: +1-800-321-6703 | Europe: +39 0536 843418
China: +86 21 66314055 | International Direct: +1-715-234-9171

EXTENDED BUSINESS HOURS

Monday through Friday from 6:30 a.m. to 6:30 p.m.
Saturday from 8:00 a.m. to 12:00 p.m. Central Time

EMERGENCY CONTACT INFORMATION

Your service doesn't stop when the office is closed and neither does ours.
Simply call 800-472-6703 and press 1 to reach on-call personnel outside
of our normal business hours.

© 2022 Rice Lake Weighing Systems PN 32332 7/22
Specifications subject to change without notice

