

SCT-2200 Advanced Series

Weight Transmitter
Version 8.05

Technical Manual



An ISO 9001 registered company
© Rice Lake Weighing Systems. All rights reserved.

Rice Lake Weighing Systems® is a registered trademark of
Rice Lake Weighing Systems.

All other brand or product names within this publication are trademarks or
registered trademarks of their respective companies.

All information contained within this publication is, to the best of our knowledge, complete and
accurate at the time of publication. Rice Lake Weighing Systems reserves the right to make
changes to the technology, features, specifications and design of the equipment without notice.

The most current version of this publication, software, firmware and all other product
updates can be found on our website:

www.ricelake.com

Contents

1.0	Introduction	1
1.1	Safety	1
1.2	Options	2
1.3	Overview	3
1.3.1	Panel Display	4
2.0	Installation	5
2.1	Location Selection	5
2.2	Electrical Precautionary Measures	5
2.3	Maximum Cable Length	5
2.3.1	Load Cell Cable	5
2.3.2	RS-232 Cable	5
2.3.3	RS-485 Cable	5
2.3.4	Analog Output Cable	5
2.4	Grounding the System	6
2.4.1	Load Cells and Junction Box	6
2.5	Wiring Schematic	7
2.6	Connection to the Load Cell	8
2.7	Input/Output Wiring	8
2.8	Legal for Trade	9
3.0	Operation	10
3.1	Basic Operation	10
3.1.1	Turn on the Instrument	10
3.1.2	Standby	10
3.1.3	Power Off the Instrument	10
3.1.4	Zero	10
3.1.5	Tare	11
3.2	Multi-Range Function	12
3.3	Display Configuration Data	12
3.4	Selecting Printing Functions	12
3.5	Selecting the Operating Mode	13
3.5.1	Conversion	13
3.5.2	Alibi Memory	13
3.5.3	Sensitivity Times Ten	14
3.5.4	Peak Hold Weight Detection	15
4.0	Setup Mode	16
4.1	Setup Mode Navigation	16
4.2	Quick Setup Menu	17
4.2.1	Default Factory Calibration	18
4.2.2	Theoretical Calibration	18
4.2.3	Calibration Using a Known Weight	18
4.2.4	Analog Output	18
4.2.5	Inputs	18
4.2.6	Output Functions	18
4.2.7	Fieldbus Parameters	18
4.3	Setup Mode Menu	19
4.3.1	F.Mode Parameters	20



Technical training seminars are available through Rice Lake Weighing Systems. Course descriptions and dates can be viewed at www.ricelake.com/training or obtained by calling 715-234-9171 and asking for the training department.

4.3.2	Setup Parameters	21
4.3.3	Diagnostic Menu	22
4.4	Configuration Menu	23
4.4.1	Filter Parameters	25
4.5	Input/Output Functions	26
4.5.1	Input Functions	26
4.5.2	Output Functions	27
4.6	Analog Output Option	29
4.7	Audit Menu	31
4.7.1	Access the Audit Menu	31
5.0	Calibration	32
5.1	Calibration Menu	32
5.1.1	Calibration Parameters	33
5.2	Calibration Procedure	33
5.3	Theoretical Calibration	34
5.4	Setting Local Gravity	35
5.5	Zero Dead Load A/D Counts	36
6.0	Communications	37
6.1	Serial Outputs	37
6.1.1	COM1 Serial Port	37
6.1.2	COM2 Serial Port	37
6.2	Serial Port Transmission Modes	38
6.2.1	PC Port Selection	38
6.2.2	PRN PORT	39
6.2.3	PC PORT	40
6.3	Serial Commands Format	41
6.4	Transmission Protocols	46
6.4.1	Standard String	46
6.4.2	Extended String	46
6.4.3	Secondary Mode Strings	47
7.0	Troubleshooting	48
8.0	Compliance	49
9.0	Specifications	50



Rice Lake continually offers web-based video training on a growing selection of product-related topics at no cost. Visit www.ricelake.com/webinars

1.0 Introduction

The purpose of this manual is to help the technician understand the SCT-2200 functioning modes, key functions and display indications. This manual applies to indicators using version 8.00 or higher of the STC-2200 firmware. Configuration and calibration of the indicator can be accomplished by pressing the indicator front panel keys, the serial command set or Rice Lake Tools configuration utility. Each indicator is designed to work with one scale and has the capability to be daisy chained to one protocol interface to communicate with a network interface controller for larger jobs.



Manuals and additional resources are available from the Rice Lake Weighing Systems website at www.ricelake.com

Warranty information can be found on the website at www.ricelake.com/warranties

1.1 Safety

Safety Signal Definitions:



DANGER Indicates an imminently hazardous situation that, if not avoided, will result in death or serious injury. Includes hazards that are exposed when guards are removed.



WARNING Indicates a potentially hazardous situation that, if not avoided, could result in serious injury or death. Includes hazards that are exposed when guards are removed.



CAUTION Indicates a potentially hazardous situation that, if not avoided, could result in minor or moderate injury.



IMPORTANT Indicates information about procedures that, if not observed, could result in damage to equipment or corruption to and loss of data.

General Safety



Do not operate or work on this equipment unless this manual has been read and all instructions are understood. Failure to follow the instructions or heed the warnings could result in injury or death. Contact any Rice Lake Weighing Systems dealer for replacement manuals.



Failure to heed could result in serious injury or death.

Electric shock hazard!

There are no user serviceable parts. Refer to qualified service personnel for service.

The unit has no power switch, to completely remove DC power from the unit, disconnect the DC power cable from the main socket.

For pluggable equipment the socket outlet must be installed near the equipment and must be easily accessible.

Always disconnect from main power before performing any work on the device.

Do not allow minors (children) or inexperienced persons to operate this unit.

Do not operate without all shields and guards in place.

Do not use for purposes other than weighing applications.

Do not place fingers into slots or possible pinch points.

Do not use this product if any of the components are cracked.

Do not make alterations or modifications to the unit.

Do not remove or obscure warning labels.

Do not use near water.

General Safety Continued

IMPORTANT Failure to follow could result in damage to equipment or corruption to and loss of data.

Keep away from heat sources and direct sunlight.

Protect the instrument from environmental factors: rain, snow, dust, etc.

Do not wash, dip in water or spill liquid on the instrument.

Do not use solvents to clean the instrument.

Do not install in areas subject to explosion hazard.

Always mount the instrument and platform in a vibration free setting.

All instrument connections must be made with respect to local zone and environment standards.

1.2 Options

Features Include

- 5-key, dual-function, push button switches
- 6-digit LED display, 0.30" (8 mm) high
- (6) red LED Annunciators
- 12 - 24 VDC power
- NEMA type 1 plastic enclosure
- Mountable to a DIN 35mm rail
- Supports six wire load cell connections and 4 wire load cell connections with sense jumpers
- Two configurable digital inputs and two configurable digital outputs
- Analog Output (PN 182589)
 - 0-20 mA, 4-20 mA (Maximum 350,000 ohm)
 - 0-5 VDC, 0-10 VDC (Minimum 10,000 ohm)
- (1) RS-485 bidirectional port configurable for connection to a PC/PLC
- (1) RS-232 bidirectional port for connection to a printer or PC
- Optional communication modules:
 - PROFIBUS-DP
 - DeviceNet
 - PROFINET IO
 - EtherNet/IP
 - EtherNet TCP/IP (Wi-Fi or RJ45)
 - Modbus TCP/IP
 - EtherCAT
 - CANopen
- Modbus RTU through serial or RS-485 port. No optional Module needed
- Unit of measure conversion
- Peak detector
- Alibi memory
- Weight or Theoretical calibration with linearity points

1.3 Overview

Case Dimensions and Connections

The instrument has a plastic case; external dimensions and connections are shown in [Figure 1-1](#).

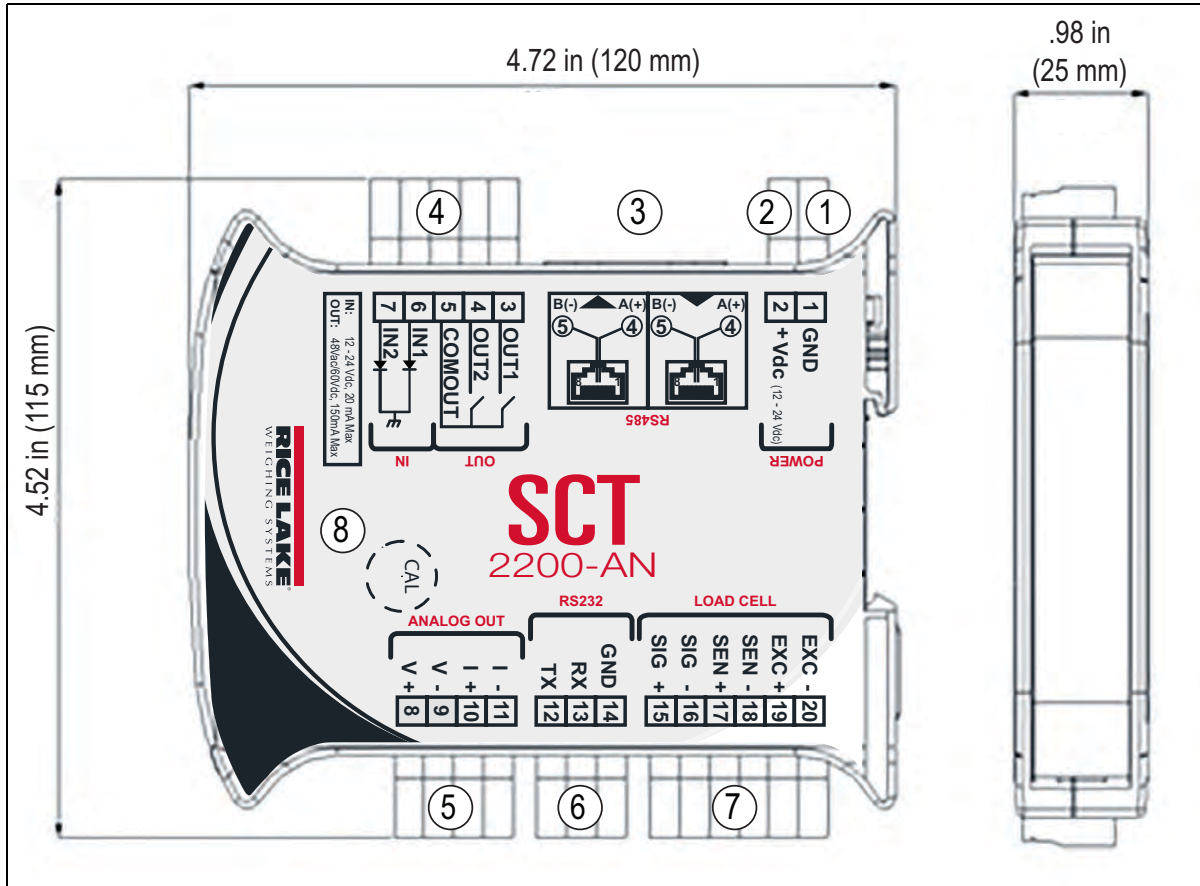

Figure 1-1. SCT-2200 Dimensions and Connections

Item No.	Description
1	GND power supply input
2	(+) 12-24 VDC power supply input
3	Connection for serial line RS-485
4	Digital I/O
5	Analog output (PN 182589 only)
6	Connection for serial line RS-232
7	Connection for load cell
8	Access point to J1 to restrict calibration

Table 1-1. SCT-2200 Connections

1.3.1 Panel Display

The front panel of the SCT-2200 consists of a display with six digits that are 0.31 in (8 mm) high, six LED annunciators and a five key keyboard.

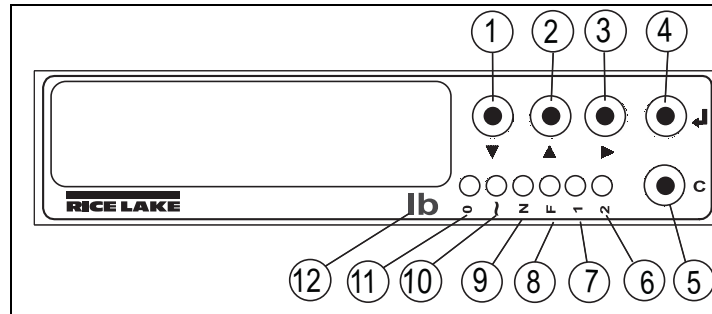

Figure 1-2. SCT-2200 Front Panel

Item No.	Symbol	Description
1	▼	ZERO – Clears the displayed gross weight of up to $\pm 2\%$ of the total capacity; Cancels tare At power up: Momentary press during startup displays current settings. See Section 3.1.1 on page 10 In setup: scroll through parameters In numeric input: decreases the digit to be modified
2	▲	TARE – Momentary press executes semiautomatic tare; Cancels tare At power up: Momentary press during startup displays setup mode. See Section 4.1 on page 16 Long press allows for entering a manual tare from the keyboard In setup: scroll through the parameters In numeric input: increases the digit to be modified
3	▶	MODE – Executes a specific function (set in the setup mode) See Section 3.5 on page 13 At power up: Momentary press during startup displays quick setup menu. See Section Figure 1-2 . In setup: quickly position the first step of a menu In numeric input: selects the digit to be modified, from left to right
4	←	PRINT – Executes a specific function (set in the setup mode) See Section 4.5 on page 26 Executes a printout or transmission of data from the serial port dedicated to the printer In setup: enter into a parameter or to confirm a setting In numeric input: confirms the entry made
5	C	ON/OFF – Turns the instrument on and off In setup: press multiple times to display <i>SRUP</i> and/or press to exit a step without confirming the setting In numeric input: momentary press clears the present value Long press beyond <i>OFF</i> : Displays information of the scale (capacity, division, minimum weight for each configured range, gravitational acceleration value, number of configured channels)
6	2	Indicates the activation of the second output (Sp2)
7	1	Indicates the activation of the first output (Sp1)
8	F	Illuminates: <ul style="list-style-type: none"> when the specification function of the instrument is active (set in <i>F. Mode</i> → <i>FUNCTION</i> parameter) See Section 3.5 on page 13 when a key is pressed Turns off: <ul style="list-style-type: none"> when the specification function of the instrument is disabled with an active function (a key is released) Blinking means the instrument function is active for five seconds
9	N	Illuminates when a tare is established, measuring net weight
10	~ (tilde)	Illuminates when the weight is unstable
11	0	Illuminates when the weighing system is within $\pm 1/4$ division of zero
12	Lb	Units - Lb is printed on the instrument; kg, Ton, g , stickers are included for changing the units on the overlay

Table 1-2. SCT-2200 Front Panel

2.0 Installation

Rice Lake Weighing Systems recommends the instrument and the platform (transducer) be installed on a flat level surface, that is stable and vibration free.

2.1 Location Selection

IMPORTANT *The following should be considered when selecting a location for the equipment:*

- *Dust-free*
- *Free of strong breezes or vapors*
- *Moderate temperature and humidity (59 to 86°F and 40-70%)*
- *Use waterproof conduit and couplings in order to protect the load cell cables*
- *Use a waterproof junction box to connect the cells*
- *Avoid welding with load cells installed*

IMPORTANT *During operation, unit will get hot*

When the SCT-2200 is installed inside of the electrical panel, it is recommended that the units be installed vertically 1/4" apart to a horizontal DIN rail. This minimizes heat buildup from multiple units being stacked and also enables optimal ventilation through the unit. If possible, it is recommended that the unit be installed towards the bottom of a panel to avoid the warmest parts of the panel. If panel size is small, some air circulation may be required.

2.2 Electrical Precautionary Measures

IMPORTANT *The following electrical precautionary measures must be considered when installing this equipment:*

- *Main power supply must be maintained within $\pm 10\%$ of the rated voltage*
- *Electrical best practices must be observed by the installing technician*
- *Follow recommended minimal separation distances given for cable categories, See [Section 2.3](#)*
- *The cable extension of the load cells, or signal amplifiers connecting to the serial ports and analog output, must be within stated maximum lengths, See [Section 2.3](#)*
- *It is recommended that load cell cables are shielded and run in conduit at an acceptable distance from power transmission lines to avoid signal interference and signal noise*
- *All cable runs not in conduit or otherwise shielded should be of minimal length and terminated as close to conduit exit as possible to avoid extraneous signal noise*
- *If the instrument is situated inside an electric panel, the power supply cable must be shielded and as short as possible, separate from every coil supply cable, inverter, electromotive force, and others. In addition, provide dedicated power supply to the instrument*
- *Install RC filters on the contact coils, solenoid valves and all devices producing electric fields*
- *It is recommended to leave the instrument powered on at all times to avoid condensation forming on the inside of the instrument*

2.3 Maximum Cable Length

2.3.1 Load Cell Cable

The maximum length of a standard load cell cable with sense wires is:

- 150' at 30#AWG
- 300' at 24#AWG

2.3.2 RS-232 Cable

The maximum length of an RS-232 cable is 50' at a maximum baud rate of 19200.

2.3.3 RS-485 Cable

The maximum length of RS-485 cable is 4000', See [Section 6.1 on page 37](#).

2.3.4 Analog Output Cable

The maximum length of the analog current output cable at 4-20mA is 300'.

The maximum length of the analog voltage output cable at 0-10Vdc is 150'.

2.4 Grounding the System

A centrally located, single point ground, such as the ground bar of the electric panel, must be created and/or identified for proper grounding and functioning of the system. The ground must be sized so that the total resistance of grounding is lower than 1Ω . Connect grounding points of all instrumentation, load cells, and weighing structure to this single point ground.

2.4.1 Load Cells and Junction Box

When the load cells are connected to the instrument through a junction box, the shielding of the load cell cables and the instrument must be connected to the junction box grounding.

When the load cells are directly connected to the instrument, the load cell cable shielding must be connected to the single point ground.

System cabling should be kept as short as possible to minimize noise potential. After exiting conduit or other shielding, a ferrite device should be used prior to conductor termination.

After platform and the load cell are properly grounded, connect the shield from the load cell cable to the instrument ground. See [Figure 1-1 on page 3](#).

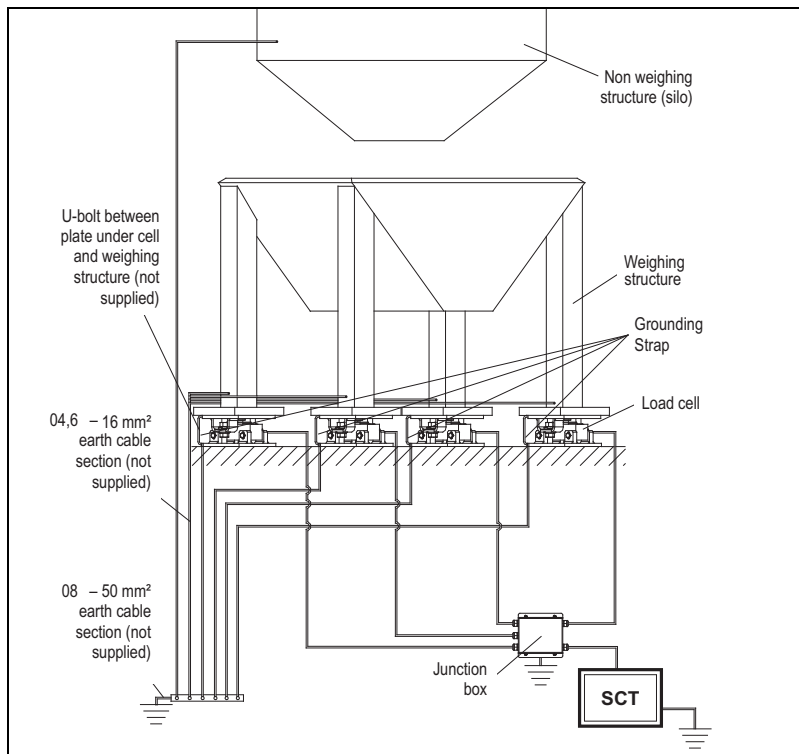

Figure 2-1. Grounding Example

IMPORTANT

Procedures not expressly described in this manual are considered improper use of the equipment.

Ensure the platform is level or the load cells are shimmed evenly.

All connections must meet all local zone and environment standards.

Follow the recommended electrical precautionary measures described in [Section 2.2 on page 5](#).

Make sure that the grounding is made correctly, See [Section 2.4](#).

2.5 Wiring Schematic

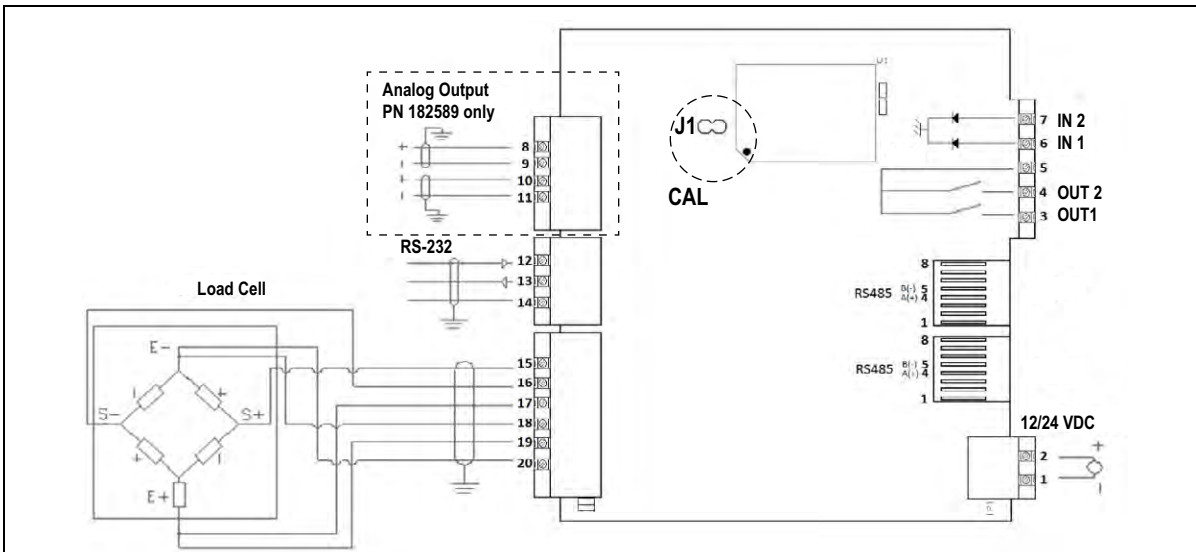

Figure 2-2. SCT-2200 Wiring Schematic

Pin Number	Label	Description
VE 12-24 Vdc Power Supply		
1	GND	0Vdc (GND)
2	+Vdc	+12-24 Vdc
Inputs and Outputs		
Outputs (48Vac or 60Vdc, 150mA max)		
3	OUT1	Output 1
4	OUT2	Output 2
5	COMOUT	Common Output
Optoisolated Inputs Positive Logic (12-24Vdc, 5-20mA max)		
6	IN1	Input 1
7	IN2	Input 2
	Connect input common to ground	
Analog Output (PN 182589 only)		
Voltage		
8	V+	+10V
9	V-	0V (GND)
Current		
10	I+	+20mA
11	I-	-0mA (GND)
NOTE:		
Max. resistance on output current: 350Ω		
Min. resistance on output voltage: 10kΩ		

Pin Number	Label	Description
Serial Port		
RS-232		
12	TX	Transmission
13	RX	Reception
14	GND	Ground
RS-485		
RJ45 Plug-IN/OUT		485 Line
RJ45 Plug-IN/OUT		485 Line
Load Cell Connections		
15	SIG+	Signal +
16	SIG-	Signal -
17	SEN+	Sense +
18	SEN-	Sense -
19	EXC+	Excitation +
20	EXC-	Excitation -

Table 2-1. SCT-2200 Wiring Schematic



Note J1 disables/enables calibration menu in SCT-2200 firmware. This function allows calibration to be limited to authorized personnel. Access to J1 is possible by breaking seal in SCT-2200 label. Restrict access to calibration by jumpering J1 and covering CAL access hole with tamper proof sticker.

2.6 Connection to the Load Cell

The load cell terminal board of the SCT-2200 must be connected to the 6-wire load cell; if using a 4-wire load, cell excitation must jumper to sense.

IMPORTANT

Sense is always enabled and, when not using 6-wire load cell, the sense terminals must be jumpered to the same polarity excitation wires.



Note

The sense compensates for drops in voltage along the cable that connects the instrument to the load cell. Voltage is lost when the instrument and the load cell are greater than 30ft apart. A cable is typically provided with a load cell. When exceeding the length of the provided load cell cable, six wires must be used to compensate for voltage drop. It is, however, recommended to never cut or shorten the load cell cable.

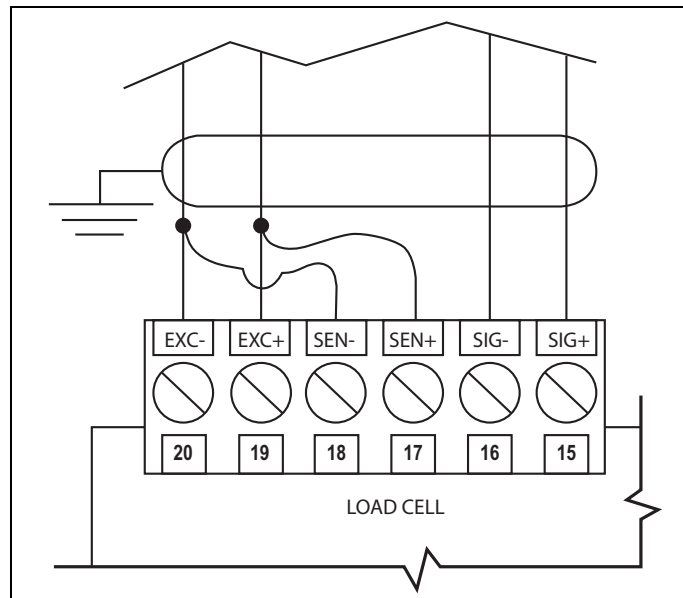

Figure 2-3. 6-Wire Connection

2.7 Input/Output Wiring

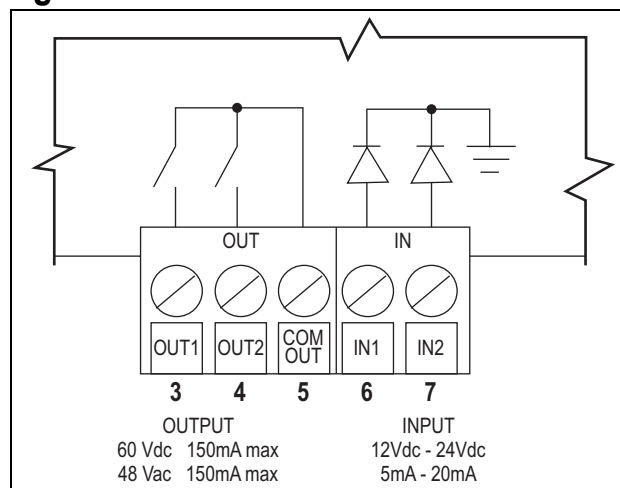

Figure 2-4. Input/Output Wiring

- Output power: 48 Vac, 150mA max (or 60 Vdc, 150mA max)
- Input voltage: 12Vdc - 24 Vdc max
- Input current: 5 mA min - 20 mA max

2.8 Legal for Trade

The SCT-2200 indicator can be sealed in Legal for Trade applications using a tamper proof sticker placed on the side seam of the indicator. The Audit menu can be accessed from weigh mode without power cycling the indicator. (See [Section 4.7 on page 31](#))

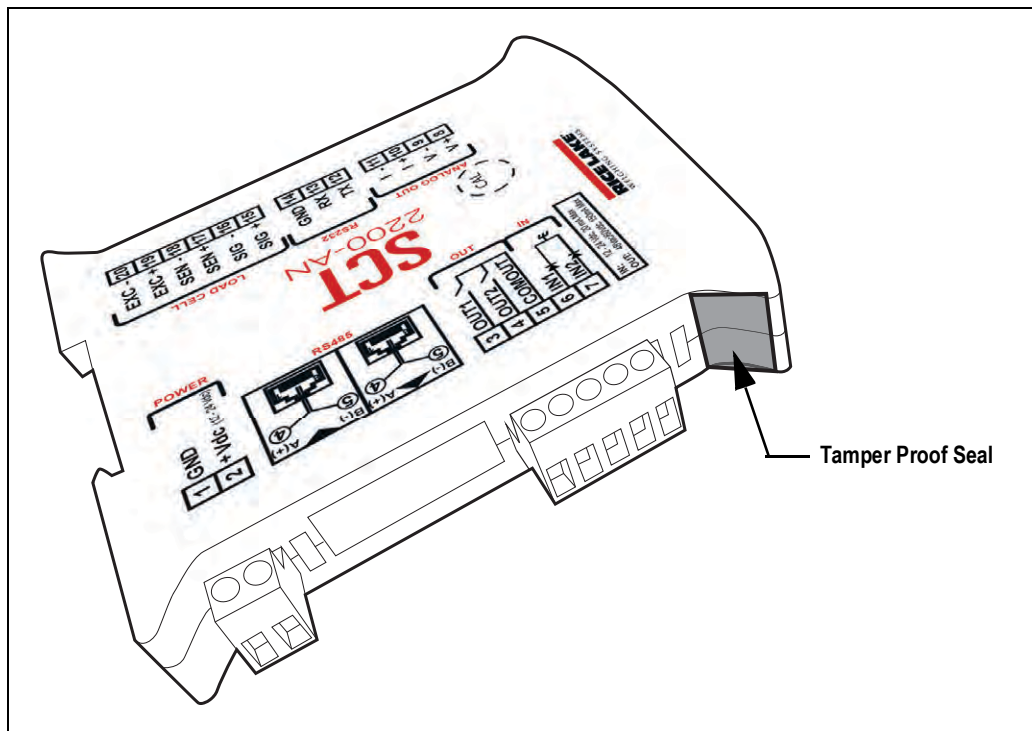

Figure 2-5. Location of Legal for Trade Seal

3.0 Operation

3.1 Basic Operation

Power must be provided to the SCT-2200 through an external AC/DC charger that supplies a stable voltage of 12 VDC or 24 VDC while connected to an appropriately rated AC power supply. Connect the two power supply wires to the appropriate terminals, see [Figure 1-1 on page 3](#) on the side of the instrument.

3.1.1 Turn on the Instrument

Press **C** until the instrument turns on, then release. The instrument executes a start up procedure and displays the installed software version.

An auto zero function zeros the instrument at startup if the weight detected on the scale is $\pm 10\%$ of the capacity. If the weight is not within this tolerance the instrument displays **zEr0** and, after 10 seconds, the current weight is displayed.



Note

The auto zero function at start-up can be disabled in the setup mode.

See **SEtUP** → **ConF** → **PARAM** → **Auto-0** in [Table 4-5 on page 24](#).

To view the following settings momentarily press **▼** while the display self-check is running:

- **HH.YY – HH** is the software release and **YY** is the sub release
- **HH.YY – HH** indicates the type of instrument, **YY** indicates the software version
- **HH.YY.ZZ** – the installed software version
- **HHHHHH** – the name of the installed software
- **HHH.HHH** – capacity and division of channel 1
- **h rE5** – displayed together with the gravitational acceleration value of the area of use

The instrument then executes a self-check.

3.1.2 Standby

Press **C** until **OFF** displays. The LED at the left of the display remains on.

3.1.3 Power Off the Instrument

To completely power off the unit, remove the power supplied voltage.

3.1.4 Zero

Press **▼** to zero a gross weight within $\pm 2\%$ of the total capacity (or as set). Weight value displays as 0 and the relative annunciators illuminate.

3.1.5 Tare

Semiautomatic Tare

Press **▲** to tare the weight value on the scale. *tArE* displays momentarily and then 0 (net weight). The relative annunciators illuminate.

Manual Tare

Press **▲** for a few seconds. *-tT-* displays and then *000000*. Enter the desired tare value with the following keys:

- **▶** selects the digit to be modified (moves left to right, selected digit blinks)
- **▼** decreases the blinking digit
- **▲** increases the blinking digit
- **C** momentary press clears the present value, long press returns to the weigh mode without saving changes
- **←** confirms the entered tare value

The tare value is subtracted from the weight on the scale and the relative annunciators illuminate.



Note *The entered tare will be rounded off to the nearest division.*

Cancel a Tare

A tare value can be manually canceled in multiple ways:

- Unload the scale and press **▲** or **▼**
- Press **C** without unloading the scale
- Enter a manual tare equal to zero

Locked or Unlocked Tare

When a tare value is entered manually, automatically or from storage the tare value displays with a negative sign when the scale is unloaded. This is known as a locked tare. An unlocked tare is automatically canceled each time the scale is unloaded.

To set the tare type:

1. Turn on the instrument and press **▲** while the firmware version displays. *F.10dE* displays.
2. Press **←** to enter the menu.
3. Press **▼** or **▲** until *tArE* displays. Press **←** to select.
4. Press **▼** or **▲** to scroll through options.
 - *L0CF* – locked tare
 - *unL0CF* – unlocked tare
 - *d,5Ab* – disable tare
5. Press **←** to confirm selection.
6. Slowly press **C** multiple times until *SAVEP* displays.
 - Press **←** to confirm and store to the instrument memory
 - Press any other key to cancel and exit without saving

3.2 Multi-Range Function

The multi-range function allows for subdividing the scale capacity in two, each up to 3000 divisions.

Example: with a 10 kg cell platform it is possible to approve the weighing system with:

Single range: 6 kg capacity and 2 g division (3000 div.)

Dual range: 6/3 kg capacity and 2/1 g division (3000 + 3000 div.)



Note

Multi-range functioning is indicated by illumination of the relative LED identifying the operating range; when the weight on the scale enters into the second range, the division of the second range is enabled. The first range division is restored only when the weight on the scale goes below the gross zero of the scale.

The selection of the range number with multi-range functioning is made during the instrument's calibration, See [Section 5.0 on page 32](#).

3.3 Display Configuration Data

The mFD function makes it possible to view the configuration data, such as:

- First range capacity, first range minimum weight, first range division
- Second range capacity, second range minimum weight, second range division (if set)
- Gravitational Acceleration Value



Note

The minimum weight corresponds to 20 net weight divisions

The data of the second range appears only if a range is configured

To view the configuration data:

1. Press and hold **C** until mFD displays.
2. Release **C**. The capacity value of the first range displays. Press **▼** or **▲** to scroll forward or back through the following data:
 - First range capacity Ch I.PAH
 - First range minimum weight Ch I.P m
 - First range division Ch I.E
 - Second range division Ch I.PAH
 - Second range minimum weight Ch I.P m
 - Second range division Ch I.E
 - Gravitational Acceleration Value GrAU iE
3. Press **C** to return to the weigh mode.

3.4 Selecting Printing Functions

Use the following procedure below to set printing functions, See [Section 4.3.1 on page 20](#):

1. Turn on the instrument and press **▲** while the firmware version displays. F.PodE displays.
2. Press **←** to enter the menu.
3. Press **▼** or **▲** until rERLE displays. Press **←** to enter the menu.
4. Press **▼** or **▲** to scroll through the options.
 - ZER0 – rearms print at zero; only prints after rearming
 - mSt – rearms print when weight becomes stable
 - ALWAYS – prints when print key is pressed, regardless of condition
5. Press **←** to confirm.
6. Slowly press **C** multiple times until SAVEP displays.
 - Press **←** to confirm and store to the instrument memory
 - Press any other key to cancel and exit without saving

3.5 Selecting the Operating Mode

In addition to the standard weighing mode, the instrument can be set to carry out four alternative operational functions. Each operating mode activates certain LEDs.

To set the operating mode:

1. Turn on the instrument and press ▲ while the firmware version displays. *F. ModE* displays.
2. Press ← to enter the menu.
3. Press ▼ or ▲ until *Funct* displays. Press ← to set parameter.
4. Press ▼ or ▲ to scroll through the options.
 - *CONV* – convert displayed value to a calculated value, see [Section 3.5.1](#)
 - *ALibi* – alibi memory, See [Section 3.5.2](#)
 - *U155* – sensitivity times ten, See [Section 3.5.3 on page 14](#)
 - *PEAK* – peak hold detector, See [Section 3.5.4 on page 15](#)
5. Press ← to confirm selection.
6. Slowly press C multiple times until *SAVE?* displays.
 - Press ← to confirm and store to the instrument memory
 - Press any other key to cancel and exit without saving

3.5.1 Conversion

This function toggles the displayed weight between the scale unit of measure and an alternative unit measure.

- Long press ► to set the conversion factor
- Short press ► to toggle between the unit of measures
- Press ← to save the conversion value

3.5.2 Alibi Memory

The alibi memory allows for transmitted weight values to be filed in the PC for data processing and/or integration. The filed values can then be recalled from the PC serial line or directly on the instrument's display for a following check.

Storage of a weight value occurs following the reception of the serial command or by pressing ←. The instrument transmits the gross and tare weights and an ID on the serial port.

The ID has the format: <Rewriting number>-<Weigh number>

- The rewriting number is a five digit number from 00000-00255; it indicates the number of complete rewritings of the alibi memory
- Weigh number is a six digit number from 000000-131072; it indicates the weigh number in the current rewriting of the alibi memory. The weigh number is increased by 000001 with each weigh storage. Once the value reaches 131072, it restarts from 000000.

The storage of a weigh value occurs only if the gross weight is greater than or equal to zero, it is stable and valid (not in under-load or overload). Depending on how *F. ModE* → *PEAK* has been configured in the technical set up, the storage of a weight by pressing a key is possible only if the condition is met (weight exceeds zero, weight instability or always).

Reviewing Stored Weigh Information

To review stored information:

1. Press **▶**. *rEH . id* displays.
2. Enter the rewriting number (from 00000-00255).
3. Press **←**. *id* displays.
4. Enter the weigh number (from 000000-131072).
5. Press **←**. The weigh information displays.
6. Press **▼** or **▲** to view the weigh information.
 - *ch . H-H* is the scale number (from 1-4)
 - *UN YY-YY* is the unit of measure (*Lb, Kg, G*)
 - *Gross* momentarily displays and then the gross weight value
 - *TARE* or *TAREPT* (manual tare) momentarily displays and then the tare weight value
7. Press **C** to return to the weigh mode.



Note

*If the alibi memory is empty and **▶** is pressed, **EMPTY** displays momentarily and the instrument returns to the weigh mode. If the entered ID is not valid, **no id** displays and the instrument returns to the weigh mode.*

Clearing the Alibi Memory

The alibi memory can be cleared directly on the instrument in the *SEtUP* → *in .AL* parameter.

1. Turn on the instrument and press **▲** while the firmware version displays. *F .ModE* displays.
2. Press **▼** until *SEtUP* displays. Press **←** to enter the menu.
3. Press **▼** or **▲** until *in .AL* displays. Press **←**. *.AL ib .P* displays.
4. Press **←** to clear the alibi memory or any other key to cancel.
 - *AL .OK* displays if the operation is successful
 - *AL .Err* displays if the memory was not successfully cleared (repeat procedure)
5. Press **C** to return to the weigh mode.

It is not possible to clear an individual weigh record.

3.5.3 Sensitivity Times Ten

This mode converts the weight to sensitivity times ten for display and is used for testing during calibration.

Press **▶** to toggle the weight display between standard sensitivity and sensitivity times ten. The last digit on the right of the display has a sensitivity equal to the scale's division divided by 10.

3.5.4 Peak Hold Weight Detection

This mode can be used to store the maximum (peak) weight value measured during the weighment.

Operation

If Peak Hold Weight Detection has been set as the functioning mode, the following functions are enabled while in weigh mode:

1. Press **▶** to enable the peak weight detection. **-PEFH-** displays alternately with the maximum weight value reached up to that point.
2. Press **▶** again to terminate the peak weight detection. Peak weight detection also terminates if the weight surpasses the maximum capacity of the instrument. In both cases, **PEFH .0F** displays and then the current weight on the scale displays. The detected weight value will be:
 - The maximum before a rapid decrease of the weight (measurement of the highest weight)
 - The maximum and persistent weight detected on the scale

Setting Sampling Time

To set the minimum sample time of the peak weight detection while in weigh mode:

1. Press and hold **←**.
2. Select **PIC.LL7**. **-LP-** displays followed by a number which corresponds to the minimum time length of the impulse expressed in hundredths of seconds.
3. Press **▼** or **▲** until the desired value displays. See [Table 3-1](#) for a list of settable values.
4. Press **←** to confirm. The instrument returns to the weigh mode.

Time in 1/100 sec	Sample per Second	Acquired Values	Mediated Values
1	400	1	1
2	200	1	1
3	100	1	1
4	100	4	2
5	50	4	2
10	25	4	2
20	12	4	2
50	6	4	2
100	6	8	2
127	6	12	2

Table 3-1. Sample Times in Peak Weight Detection

The peak detection function sensitivity is dependent on setting of samples per second. The higher the number of samplings, the greater the sensitivity. If an unexpected peak is detected immediately, decrease the sensitivity.

Example: If 0.000 lb is on the load cell of 20 lb, and the sampling time is equal to 1, when the peak function is enabled, 0.005 lb displays.

4.0 Setup Mode

The setup mode is used to set the functioning parameters of the instrument. There are two setup menus in the SCT-2200.

- The **Quick Setup** Menu is a limited menu that includes settings essential to basic scale configuration such as quick calibration and communication. To enter the quick setup menu, press **C** to turn the instrument on. Press **▶** as the firmware version displays. See [Section 4.2 on page 17](#) for more information on the quick setup menu
- The **Setup mode** Menu is a more in-depth menu that incorporates all configuration settings. To enter the setup mode, press **C** to turn the instrument on. Press **▲** as the firmware version displays. See [Section 4.3 on page 19](#) for more information on the

4.1 Setup Mode Navigation

Use the keys on the front panel of the indicator to navigate through the menu options as follows:

Key	Function
▼	Scroll through parameters In numeric input: decreases the digit to be modified
▲	Scroll through the parameters At power up: Momentary press during startup displays setup mode. In numeric input: increases the digit to be modified
▶	Quickly position at the first step of a menu At power up: Momentary press during startup displays quick setup menu. In numeric input: selects the digit to be modified, from left to right
←	Enter into a parameter or confirm setting of a parameter In numeric input: confirms the entry made
C	Exit a step without confirming the setting In setup: press multiple times to display <i>SRUEP</i> prompt and/or press to exit a step without confirming the setting In numeric input: clears the present value

Table 4-1. Key Functions in Setup Mode

4.2 Quick Setup Menu

Press **C** to turn the instrument on. Enter the quick setup menu by pressing **▶** as the firmware version displays. After every parameter, press enter to accept settings.

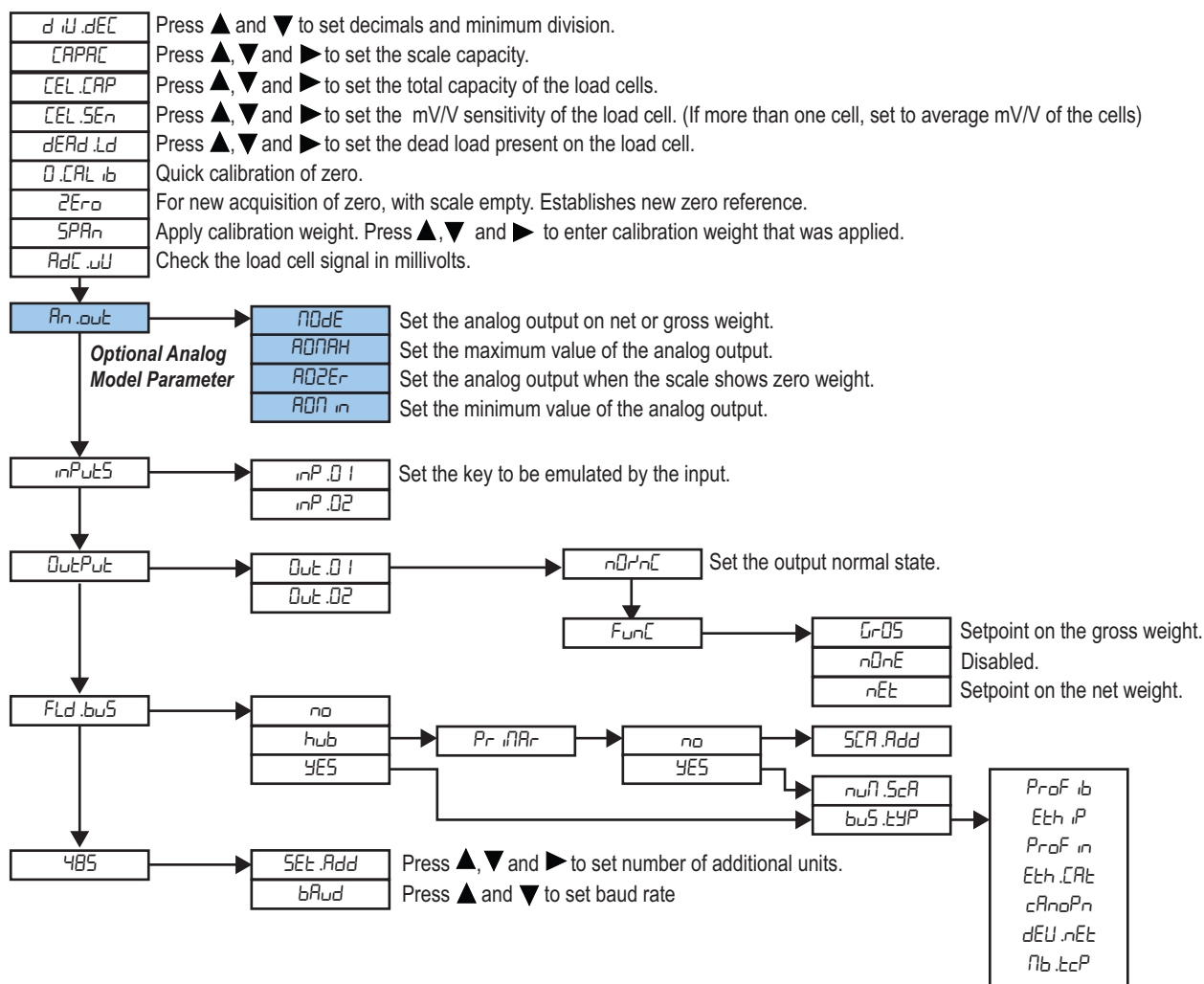

Figure 4-1. Quick Setup Menu



Note

When settings are complete press **C** until the indicator displays **SAVEP**. Press **←** to save set up and return to weigh mode. Pressing any other key exits the setup and discards changes.



















4.2.1 Default Factory Calibration

The instrument is shipped with the following default calibration settings: See [Table 4-3 on page 21](#) to return indicator to default settings.

- Capacity – 10,000 lb
- Load cell sensitivity – 2.000 mV/V
- Division – 1



















4.2.2 Theoretical Calibration

Use the quick setup menu to perform a theoretical calibration. See [Figure 4-1 on page 17](#).

1. Navigate to *d u .dEc*. Press .
2. Press  and  to set decimals and minimum division. Press .
3. Select *CEL .CAP* Press .
4. Press  and  to set the total load capacity of the load cells. Press .
5. Select *CEL .SEn*. Press .
6. Press ,  and  to set the mV/V sensitivity of the load cell. Press .
7. Select *dERd .Ld*. Press .
8. Press ,  and  to set the weight value of the dead load present on the load cell. Press .
9. Slowly press *C* multiple times until *SAUEP* displays.
 - Press  to exit and save the calibration
 - Press any other key to exit without saving

4.2.3 Calibration Using a Known Weight

Use the quick setup menu ([Figure 4-1 on page 17](#)) to perform a standard calibration with a known weight.

1. Select *d u .dEc*. Press .
2. Press  and  to select decimals and minimum division. Press .
3. Select *CAPAC*. Press .
4. Press ,  and  to set capacity. Press .
5. Select *CAL .lb*. Press .
6. Clear weight from scale. Press . *CAL .OP* Displays. Press .
7. Select *SPAn*. Press .
8. Press ,  and  to set the weight value used for the calibration.
9. Place calibration weight on scale. Press .
10. Slowly press *C* multiple times until *SAUEP* displays.
 - Press  to exit and save the calibration
 - Press any other key to exit without saving

4.2.4 Analog Output

See [Section 4.6 on page 29](#) for Analog Output Settings.

4.2.5 Inputs

See [Section 4.3.2 on page 21](#) for Input setup parameters.

4.2.6 Output Functions

See [Section 4.5 on page 26](#) for Output Functions.

4.2.7 Fieldbus Parameters

For detailed Fieldbus configuration information, See Fieldbus Card Manual (RLWS Part #183523).

4.3 Setup Mode Menu

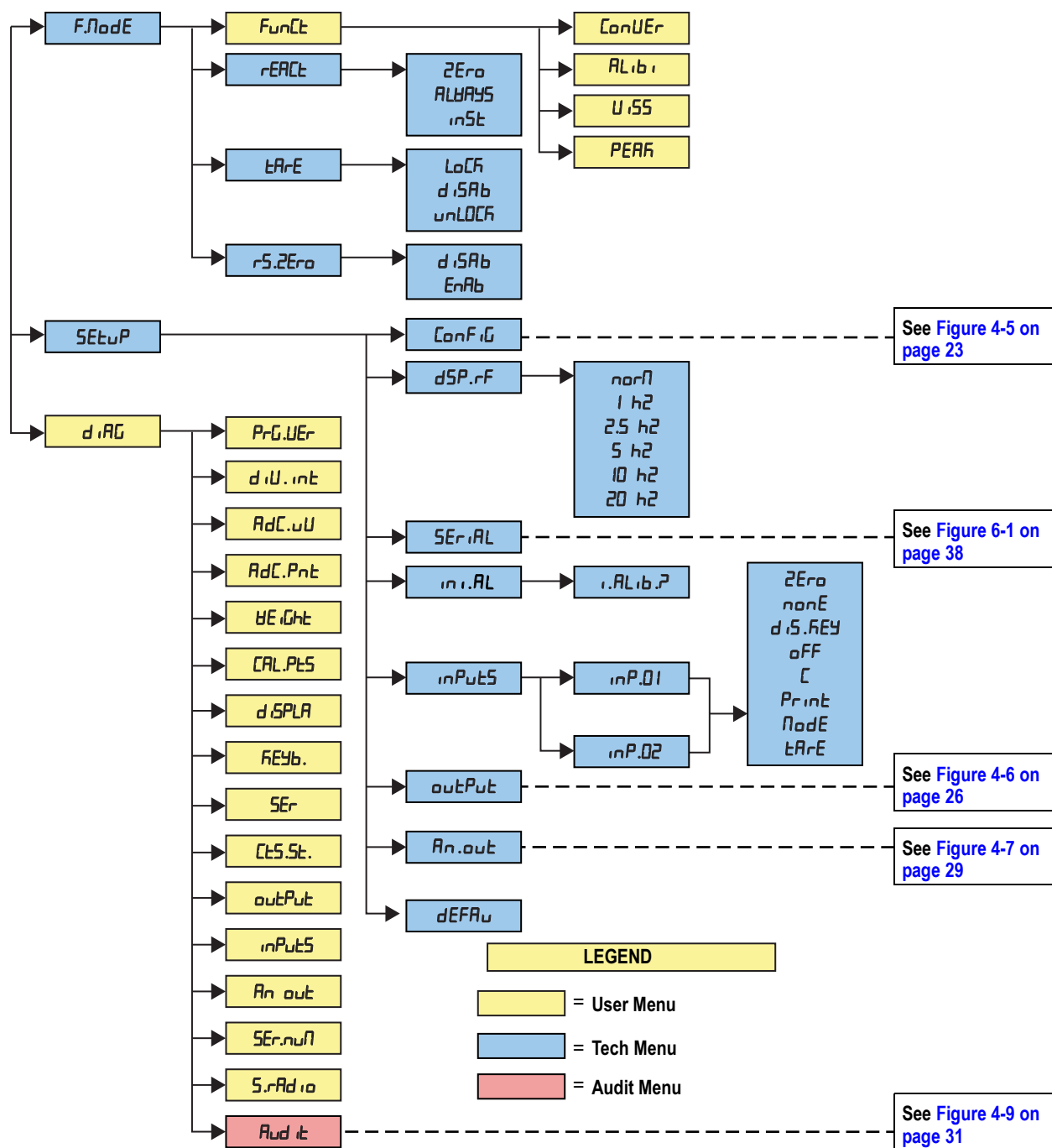

Figure 4-2. Setup Mode Menu



Note Settings adjusted in Tech Menu will increment the Audit Trail. Settings adjusted in the User Menu will not increment the Audit Trail.

4.3.1 F.Mode Parameters

The function mode parameters set the functionality of the scale. The function mode parameters set four operations that can be accessed with the > key. It also sets the functionality of printing, taring and zeroing.

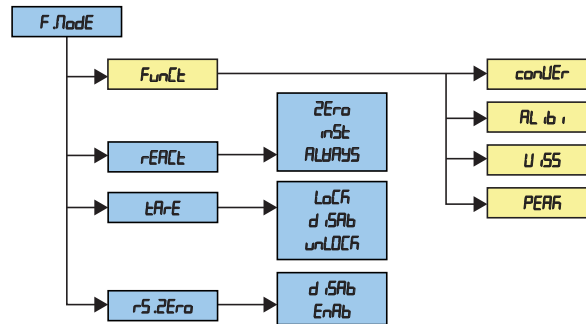

Figure 4-3. F.Mode Menu

Parameter	Settings	Description
FuncT		Functioning Mode NOTE: For the details of the operating modes, See Section 3.5 on page 13. Once the functioning mode is selected, if a printer is configured, the printout follows the selected function.
	conUEr	Convert the current displayed value to a calculated value; if the Mode key is pressed for 1 second, the conversion value can be edited, See Section 3.5.1 on page 13
	ALib i	Alibi memory, See Section 3.5.2 on page 13
	U.SS	Sensitivity times ten when the mode key is pressed, See Section 3.5.3 on page 14
	PEAK	Peak hold detector displays PEAK and alternates with displaying the highest captured value after the mode key is pressed, See Section 3.5.4 on page 15
rErEt		Sets the re-enable function of printout based on this criteria: rearm at zero, rearm when weight is unstable, or always print when the print button is pressed, See Section 3.4 on page 12
	zErO	Rearms print function after weight returns to zero; only prints once after rearming
	ALWAYS	Always prints when print key is pressed
tAr-E	inSt	Instability rearms the print function when the weight becomes unstable; only prints once after rearming and weight becomes stable
		When a tare value is entered manually, automatically or from storage the tare value displays with a negative sign when the scale is unloaded. This is known as a locked tare. An unlocked tare is automatically canceled each time the scale is unloaded, See Section 3.1.5 on page 11
	LoCk	Retains tare value until manually cleared
	d.SAb	Tare value cannot be entered
rS.zErO	unLoCk	Tare value is automatically cleared when gross weight is zero
		Enables restoring the last captured zero after a power cycle
	d.SAb	Disables restore zero after power cycle
	EnAb	Enables restore zero after power cycle

Table 4-2. Function Mode Parameter

4.3.2 Setup Parameters

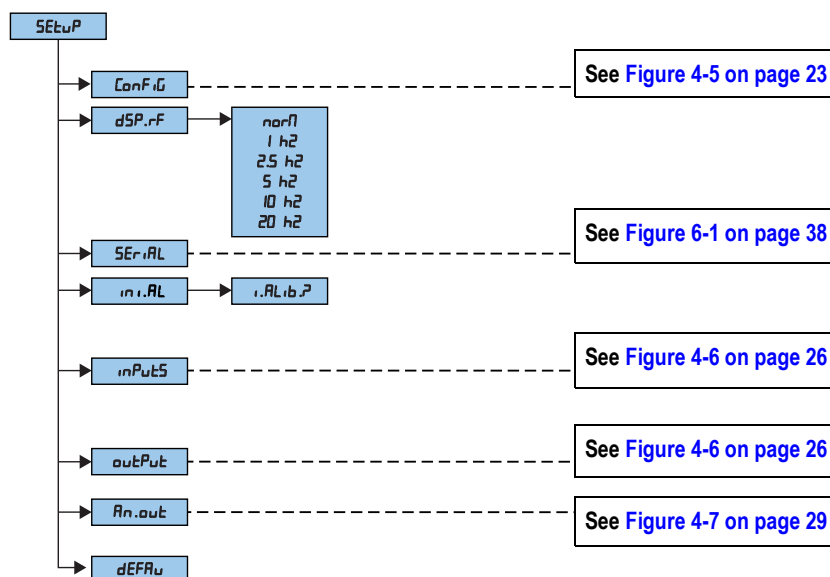

Figure 4-4. Setup Menu

Parameter	Settings	Description
ConF.iG		Configuration Parameter - See Table 4-5 on page 24
dSP.rF		Sets the speed of the display refresh
	norF	The function is disabled
	20 h2	20 display update / sec refresh rate
	10 h2	10 display update / sec refresh rate
	5 h2	5 display update / sec refresh rate
	2.5 h2	2.5 display update / sec refresh rate
SEr.iAL		Serial Communications Setup, See Table 6-4 on page 40
in.i.AL		Initialize alibi memory – the initialization cancels all the data stored in the alibi memory; press ← to enter the operation, then i.AL.i.b.P displays; press ← again to confirm or any other key to cancel; AL.DF displays if the operation is successful; if not, AL.Err displays; the parameter displays only if the alibi functioning mode is selected
inPUtS		Input Configuration – sets the function of each input, See Section 4.5.1 on page 26
ouTpuT		Output configuration – See Table 4-6 on page 26
An.ouT		Analog output – See Table 4-9 on page 29
dEFRAU		Default settings – restores instrument default settings; press ← ; dEFRAU displays; press ← to confirm or exit by pressing any other key NOTE: Returning the instrument to default settings cancels the present calibration.

Table 4-3. Setup Parameters

4.3.3 Diagnostic Menu

See the [Figure 4-2 on page 19](#) for the diagnostic (*d iRL*) menu structure.

Settings	Description
<i>PrG .UEr</i>	Press to display the software version
<i>d iU .int</i>	Press to display the calibration internal divisions
<i>RdC .uU</i>	Press to display the microvolts relative to the weight on the scale; use or to display the microvolts of the scale NOTE: The maximum input voltage the instrument accepts is 30 mV (30000 μV); the scale system is powered by the instrument at 5 Vdc; in a properly operating system there will be less than 30000 μV with full capacity on the scale system
<i>RdC .Pnt</i>	Press to display the A/D converter points relative to the weight on the scale; press or to display the A/D converter points for each configured channel. See Table 4-10 on page 30 for ideal Raw A/D count numbers.
<i>WE iGht</i>	Press to display the weight on the scale; press or to view the weight on each connected scale
<i>CAL .PES</i>	Press to alternately display the A/D converter points and the corresponding weight value; use or to display for each calibration point and relative weight value
<i>d iSPLR</i>	Display Test – press to turn on display segments one at a time; continue pressing ; The instrument turns on the display segments, one at a time, then exits automatically from this step
<i>KEYb</i>	Keyboard Test – press , then 0000 displays; press the keys on the keyboard, one at a time, to display related codes; press any key three times to exit
<i>SEr</i>	RS-232 Serial Port Test – press , then 5 <i>HY</i> ; <i>H</i> displays, in which <i>Y</i> indicates the status of the PC serial port <ul style="list-style-type: none"> • <i>0</i> – Serial port is not working • <i>1</i> – Serial port is working Press or to change the status of the serial port
<i>CTS .St</i>	CTS Status Test – press to view the CTS signal status of the printer connected to the PRN serial port
<i>outPut</i>	Output Test – press , displays <i>rEL . 1</i> and output 1 is enabled; press or to enable the other outputs
<i>inPutS</i>	Input status – press , displays <i>in .bH-Y</i> ; <i>H</i> displays, in which <i>Y</i> indicates the input status <ul style="list-style-type: none"> • <i>0</i> – disabled • <i>1</i> – enabled Press or to change the input status
<i>An out</i>	Analog Output Test – provides a basic test to verify correlation of weight and analog output, when equipped with analog output option; See Section 4.6 on page 29 Press , 00000 displays. Enter a value between 00000 and 65535 and confirm by pressing ; the instrument assigns the corresponding analog value in output Press on the same entered value to exit
<i>SEr .nuñ</i>	Serial Number – Displays the instrument's serial number
<i>S .rAd io</i>	Press to select the desired radio channel; <i>0F</i> displays if the configuration is successful, <i>ErrOr</i> displays if not successful
<i>Rud it</i>	Press to view counters for System Configuration, Scale Configuration, and Scale Calibration; See Section 4.7 on page 31

Table 4-4. Diagnostics Menu

4.4 Configuration Menu

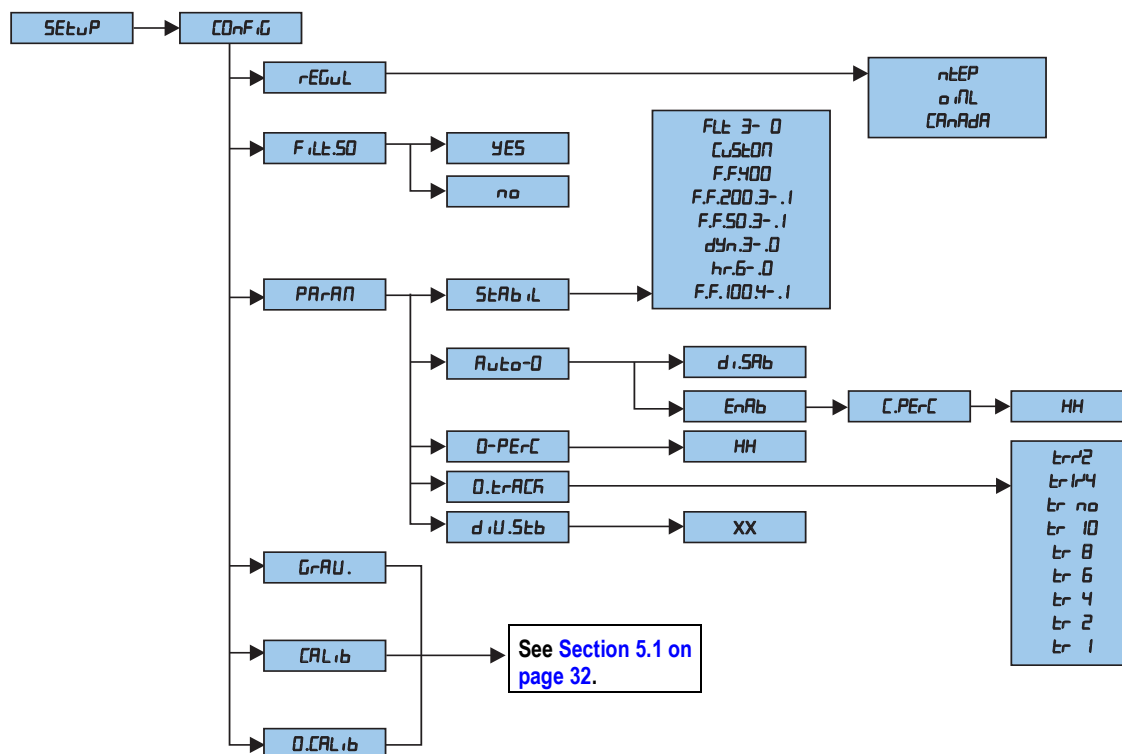

Figure 4-5. Configuration Menu

Parameter	Settings	Description
rEGUL	nTEP OIML CARRdR	Selection of regulatory body NTEP OIML Measurement Canada
FILT 50	no = disable YES = enable	Enable or disable the 50Hz filter
PARAM	Metrologic parameters	
	SEAb IL	Select and set the type and degree of filtering; See Section 4.4.1 on page 25 FLE 0-3 – filter for simple weighing CUSTOM – customizable filter for manufacturer use F.F. 200 . 1-3 – filter at 200 Hz F.F. 50 . 1-3 – filter at 50 Hz dYN . 0-3 – filter for crane scale h.r. 0-6 – filter for high resolution F.F. 100 . 1-4 – filter at 100 Hz F.F. 400 – filter at 400 Hz With a Legal for Trade instrument, only the FLE 0, FLE 1, FLE 2, FLE 3 parameters can be selected.
	Auto-0	Automatic acquisition of the gross zero at startup (default is 2% of capacity) d 5Ab – disabled EnAb – enabled on scale 1 NOTE: If auto zero is enabled, 0.PERC displays and a value between 1 and 50 as a percentage of the capacity of the auto zero must be set.
	0-PERC	Zero capacity – This menu allows to set (0-50%) of capacity that can be zeroed by pressing zero key (▼); Entering 0% disables the zero key (▼)
	0.TRACK	Zero tracking – This menu allows setting the zero tracking (compensation parameter of the scale's thermal drift); the set value corresponds to the number of divisions tracked off in 1 second tr 1/2 – ± half division tr 1/4 – ± one fourth of a division tr no – tracking disabled tr 10 – ± ten divisions tr 8 – ± eight divisions tr 6 – ± six divisions tr 4 – ± four divisions tr 2 – ± two divisions tr 1 – ± one division
	d W.Stb	Divisions by stability – enter the number of divisions by which the instrument detects the weight stability; a higher number of divisions makes stability more easily detected; Settable values are 0 (weight always stable) to 99
GRAV.	--	Gravity acceleration – See Section 5.4 on page 35
CAL ib	--	Scale calibration – See Section 5.0 on page 32
0.CAL ib	--	Zero calibration – See Section 5.0 on page 32

Table 4-5. Config Menu Parameters and Settings

4.4.1 Filter Parameters

Standard digital filtering uses mathematical averaging to compensate for the noise that the A/D converter sends periodically because of external vibration. This filter compensation makes data less susceptible to a DC signal bias error for some signals.

Each of the filters of the SCT-2200 are intended to compensate for different types and intensities of digital noise and vibration. Below, find general usage for each family of filters and the A/D Rate and Window for each filter within those families:

Name	A/D Rate	Window	Name	A/D Rate	Window
Static Weighing on platform			Suspended and oscillating loads		
FLT3	25	24	dyn.3	6	12
FLT2	25	16	dyn.2	6	12
FLT1	25	12	dyn.1	6	12
FLT0	25	8	dyn.0	6	12
CUSTOM	For manufacturer use only		High Resolution Weighing		
High Speed Weight Capture			h.r.6	6	32
F.F.400	400	24	h.r.5	6	24
Filling or Dosing			h.r.4	6	24
F.200.3	200	30	h.r.3	6	12
F.200.2	200	32	h.r.2	6	12
F.200.1	200	32	h.r.1	6	10
Instability, motion or vibration			h.r.0	6	8
F.50.3	50	20	Filling or Dosing		
F.50.2	50	22	F.100.4	100	26
F.50.1	50	22	F.100.3	100	24
			F.100.2	100	20
			F.100.1	100	10

Table 4-6. Filter Values

4.5 Input/Output Functions

The instrument is fitted with two opto-isolated inputs and two dry contact outputs. See specifications in [Section 2.7 on page 8](#).

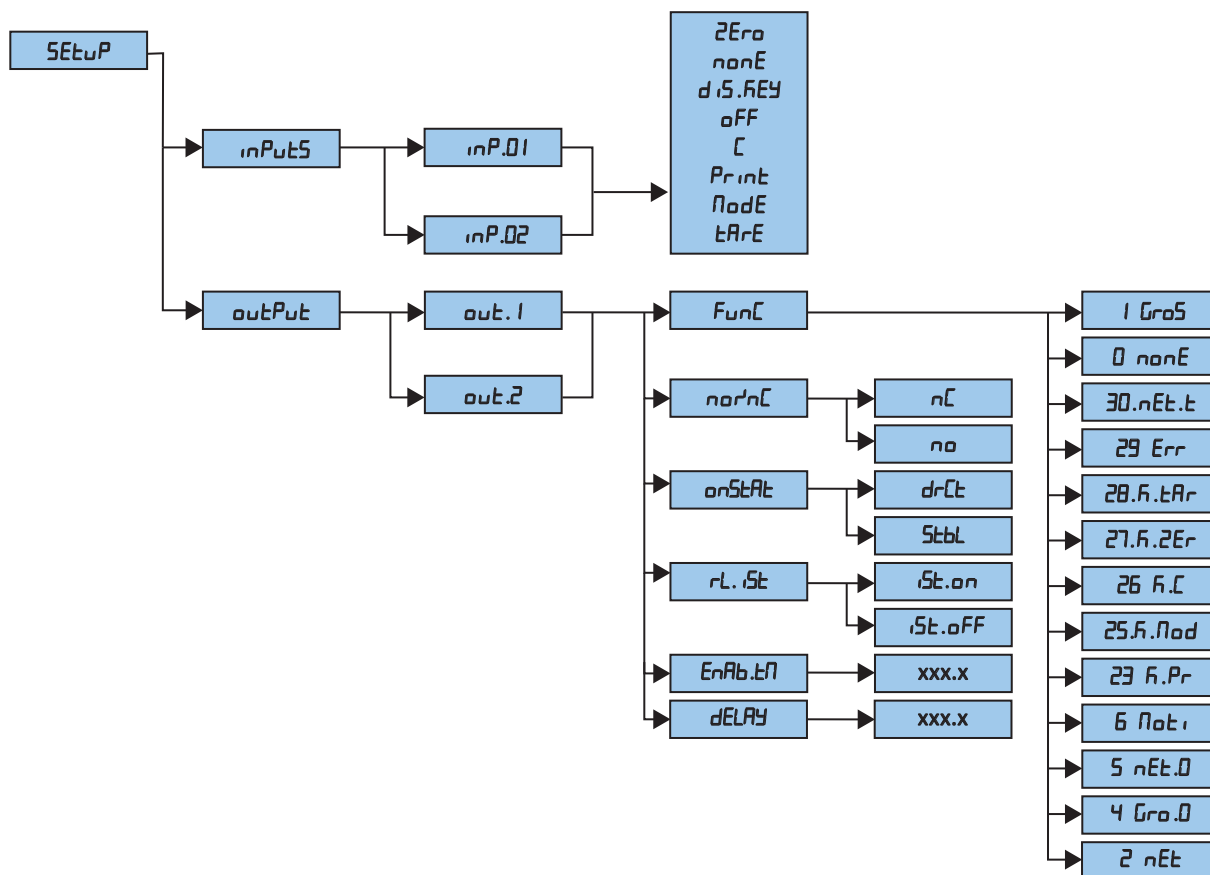

Figure 4-6. Output Menu

4.5.1 Input Functions

The input configuration menu sets the function of each of the inputs.

Parameter	Settings	Description
inPuTs	inP.01	Input 1 or Input 2
	inP.02	NOTE: In the event two inputs are simultaneously enabled, only the lowest number input will activate.
		ZEro – Zero key
		nonE – Disabled (Default for input 1)
		dIS.kEY – Disables the keyboard
		oFF – Turning off the instrument
		C – C key – ON/OFF key
		Pr inT – Print key
		ModE – Mode key (Default for input 2)
		tARrE – Tare key

Table 4-7. Input Functions

4.5.2 Output Functions

The parameters of each of the outputs is set in the setup *OUTPUT* menu, See [Figure 4-6 on page 26](#).



Note Some of functioning modes of the outputs are relative to the specific functioning modes of the instrument; see the following descriptions for the details.

Parameter	Settings	Description
FUNC	Define the functionality of each output	
	IGROSS	<p>Setpoint based on the gross weight (Default)</p> <p>Functioning with hysteresis (RL. SET parameter set at SET.ON)</p> <p>Setpoint based on gross weight; Two setpoints for each output must be set; one which disables the output when the gross weight falls below that setpoint; and one which enables the output when the gross weight is equal or greater than that setpoint</p> <ol style="list-style-type: none"> 1. Press and hold to enter the setpoint values for each configured output 2. Select <i>INP.SETP. 5. I ON</i> displays (output 1 – this enables the setpoint). Press 3. Enter the weight value. See Section 4.1 on page 16 for key function. Press to confirm. <i>5. I OFF</i> displays (output 1 – this disables setpoint) Press 4. Enter the weight value. Press to confirm 5. Repeat steps 1 to 8 for all outputs 6. Slowly press multiple times until <i>SAVEP</i> displays <ul style="list-style-type: none"> - Press to confirm and store to the instrument memory - Press any other key to cancel and exit without saving
		<p>Functioning without hysteresis (RL. SET parameter set at SET.OFF)</p> <p>Setpoint based on gross weight; One setpoint for each output is set</p> <ol style="list-style-type: none"> 1. Press and hold to enter the setpoint values for each configured output 2. Select <i>INP.SETP. 5. I ON</i> displays (output 1 – enabling setpoint) Press 3. Enter the weight value; See Section 4.1 on page 16 for key function. Press to confirm 4. Repeat steps 1 to 5 for all outputs 5. Slowly press multiple times until <i>SAVEP</i> displays <ul style="list-style-type: none"> - Press to confirm and store to the instrument memory - Press any other key to cancel and exit without saving <ul style="list-style-type: none"> • The configuration of setpoints cannot be accessed if all outputs are set in the <i>NONE</i> functioning mode, or if the selected functioning mode does not require entry of a setpoint value • With the instrument off or in standby outputs are normally open • The disabling setpoint must be equal to or less than the enabling setpoint; if the disabling setpoint is set at a value greater than the enabling setpoint the instrument sets the setpoint to zero until a valid value is entered • If the enabling setpoint is set at a value lower than the disabling setpoint, the enabling setpoint is entered and accepted, however, the disabling setpoint will be set to zero • A zero value is valid on both the enabling and disabling setpoints • A setpoint value remains active while modifying the setpoint until the new value is confirmed • The tare operations are active • These outputs are enabled by pressing a key (, , , or); if the key press time is greater than two seconds the output is disabled and remains disabled
	NONE	No function, this output is inactive
NET	<p>Setpoint based on net weight. Setpoints are set in the same manner as gross weight; See <i>IGROSS</i> above. In addition setpoints can be set and activated on a negative weight</p> <ul style="list-style-type: none"> • Positive weight (<i>5. ION</i> set at <i>POS.ET</i>) • Negative weight (<i>5. ION</i> set at <i>NEG.ET</i>) 	
NET.T	Setpoint based on the net weight with tare activated; selecting this mode the function of the output on the net weight is activated if a tare is entered	

Table 4-8. Output Functions

Parameter	Settings	Description
Func	29 Err	Error indication. Function of the output is enabled on an invalid weight (overload/underload), or without the signal coming from the cell (disconnected cell)
	28 F.tAr	Tare Key – function is enabled when ▲ is pressed
	27 F.zEr	Zero Key – function is enabled when ▼ is pressed
	26 F.c	C Key – function is enabled when C is pressed
	25 F.Mod	Mode Key – function is enabled when ► is pressed
	23 F.Pr	Print Key – function is enabled when the ◀ is pressed
	6 noSt	Instability – Output is on for an unstable weight
	5 nEt.o	Setpoint based on net weight being at zero
	4 Gro.0	Setpoint based on gross weight being at zero
no/nC	NO/NC Contacts <ul style="list-style-type: none"> no – output normally opened nC – output normally closed 	
onStAt	Switching condition <ul style="list-style-type: none"> drCt – the output is activated when the weight reaches the set threshold, (independently from the stability) and is disabled when the weight goes below the set disabling threshold StbL – the output is activated when the weight, after reaching the set activation thresholds, becomes stable; the output is disabled when the weight, after going below the set disabling threshold, becomes stable 	
rL .st	Hysteresis <ul style="list-style-type: none"> .st .oFF – hysteresis disabled .st .on – hysteresis enabled 	
EnAb.tn	Enabling time – enter the length of time the output is enabled in seconds (4 digits with a decimal); the output is disabled once the set time has passed, starting from the moment of the activation (see dELAY); by setting 000.0 the output remains always active NOTE: The delay time is only evaluated when a setpoint on gross weight, setpoint on net weight or is selected as an output function.	
dELAY	Enables delay period – enter the enabling delay period in seconds (4 digits with a decimal); The output is enabled once the set time has passed, starting from the moment the condition takes place; By setting 000.0 the output is enabled when the enabling condition takes place NOTE: The output is enabled only if the enabling condition takes place for the length of time set. The delay is valid only for the enabling of the output. When the enabling condition no longer takes place the output is disabled. In a switching condition with stability, the output is enabled only when the weight is stable. The delay time is evaluated when a setpoint on gross weight or setpoint on net weight is selected as an output function.	

Table 4-8. Output Functions (Continued)

4.6 Analog Output Option

An optional analog output is configurable at 0-20mA, 4-20mA, 0-10Vdc, 0-5Vdc; with minimum and maximum settable values. The output voltage and the current from the interface are proportional to the gross weight or net weight present on the scale.

The analog output is updated every 20ms and takes on the value corresponding to the weight converted in that instant; therefore, as the filter is increased, the analog output update rate will slow down.



Note Scale needs to be calibrated per Section 5 before analog output can be calibrated

To configure the parameters, enter the setup mode and $SEtUP \rightarrow An.out$.

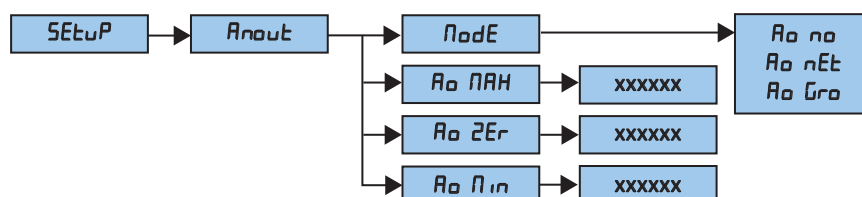

Figure 4-7. Analog Output Menu

Parameter	Description
$ModE$	<p>Select the type of analog output:</p> <ul style="list-style-type: none"> $An.no$ – analog output disabled $An.Gro$ – analog output tracks gross weight $An.nEt$ – analog output tracks net weight <p>Once the functioning mode is confirmed, set the values of the analog output; the digital/analog converter values are entered (between 0-65535) which corresponds to an output value in voltage or in current</p> <p>The instrument keys have the functions:</p> <ul style="list-style-type: none"> ▼ – decreases the selected digit (blinking) ▲ – increases the selected digit (blinking) ▶ – selects the digit (blinking) from left to right ← – press once to enter a value, the corresponding output analog value is enabled; press a second time to confirm and exit the step C – press to quickly zero the present value to 000000
$An.MA$	<p>Set the maximum value of the analog output:</p> <ul style="list-style-type: none"> With a positive weight – the value of the output when the weight is greater than or equal to the full scale capacity; also corresponds to the overload condition With negative weight – the value of the output when the negative weight is greater than or equal to the full scale capacity, also corresponds to the underload condition <p>The value can be between 0-65535 (values of the digital/analog converter); if a higher value is entered, the instrument zeros the value</p>
$An.ZEr$	<p>Set the analog output value when the scale displays zero weight (supplied when the scale is in underload); this value can be between 0-65535 (values of the digital/analog converter); if a higher value is entered, the instrument zeros it</p>
$An.Min$	<p>Set the minimum value of the analog output:</p> <ul style="list-style-type: none"> With positive weight – the minimum value provided by the analog output, corresponding also to the underload condition With negative weight – the minimum value provided by the analog output, corresponding also to the overload condition <p>This value can be between 0-65535 (values of the digital/analog converter); if a higher value is entered, the instrument zeros it</p>

Table 4-9. Analog Output Parameters

Calibrating Analog Output

The following calibration procedure requires a multimeter to measure voltage or current output from the analog output module.

1. Enter setup mode and go to the $R_n \text{ OUT}$ menu (see [Figure 4-7 on page 29](#)).
 - Set $R_n \text{ MIN}$ to lowest weight value to be tracked by the analog output
 - Set $R_n \text{ MAX}$ to highest weight value to be tracked by the analog output
2. Connect multimeter to analog output:
 - For voltage output, connect voltmeter leads to pins 3 and 4
 - For current output, connect ammeter leads to pins 1 and 2
3. Adjust zero calibration: Scroll to the $R_n \text{ ZER}$ parameter. Check voltage or current reading on multimeter. Press and hold ▼ or ▲ to adjust the zero value up or down.
4. Return to normal mode. Analog output function can be verified using test weights.

Approximate Values Between The DA Converter and Analog Output:

D/A Converter	Voltage	Current (mA)
1200	0	0
12700	--	4
58600	--	20
62650	10	--

Table 4-10. DA Converter and Analog Output

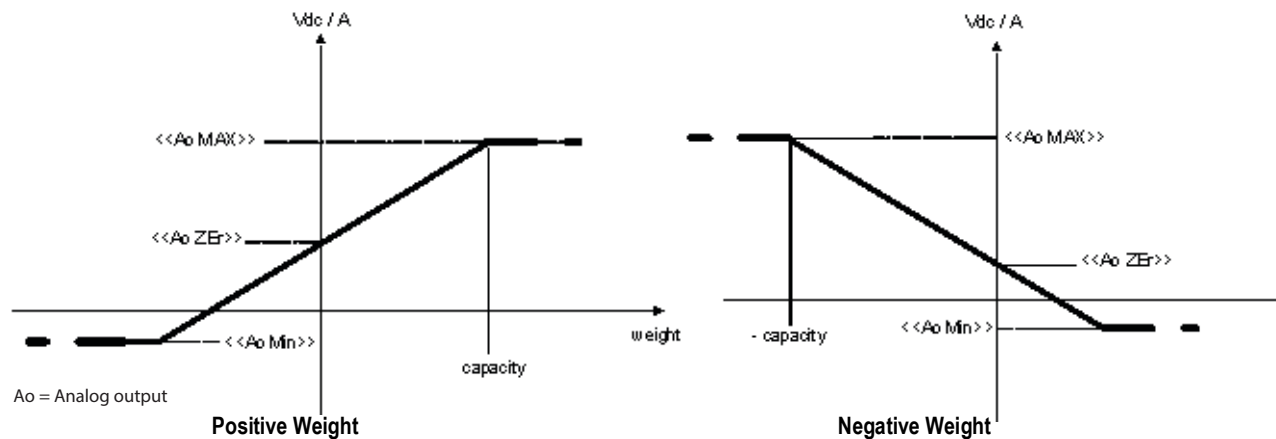

Figure 4-8. Analog Output

4.7 Audit Menu

Audit menu enables the user to view the number of times that configurations have been changed on the SCT-2200. The Audit menu is accessed from weigh mode.

4.7.1 Access the Audit Menu

The audit menu is accessed through the Setup mode or, in legal for trade applications, from weigh mode without power cycling the indicator. Indicator must be sealed as in [Section 2.8 on page 9](#) for legal for trade applications.

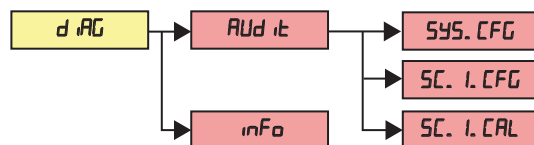

Figure 4-9. Audit Menu

Menu	Parameter	Description
AUD it	SYS.CFG	System configuration audit trail - Displays number of times that any of the following system parameters has been changed TYPE, TARE, RS.ZERO, NCHAN, AUTO-0, C.PERC, 0.PERC, GRAV, REGUL, OV.LOAD
	SC.I.CFG	Scale configuration audit trail - Displays number of times that any of the following scale parameters has been changed STABIL, 0.TRACK, DIV.STB, DEC1, UM, DIV, RANGE
	SC.I.CAL	Scale calibration audit trail - Displays number of times the scale has been calibrated
inFo		Indicator scrolls through settings

Table 4-11. Audit Menu Parameters

Access Audit Menu From Weigh Mode

1. Press and hold **C** until **AUD it** displays.
2. Press **▼**. **inFo** displays. Press **▼** again, **AUD it** displays.
3. Press **←**. Displays LRV number then displays **SYS.CFG**.
4. Press **▼** or **▲** to toggle between audit counter options.
5. Press **←** to view Audit trail number for the selected audit counter.
6. Press **C** to exit to audit counter options. Repeat Steps 4 and 5 as needed.
7. Press **C** to return to weigh mode.

5.0 Calibration

5.1 Calibration Menu

The indicator can be calibrated using a known weight or theoretically.

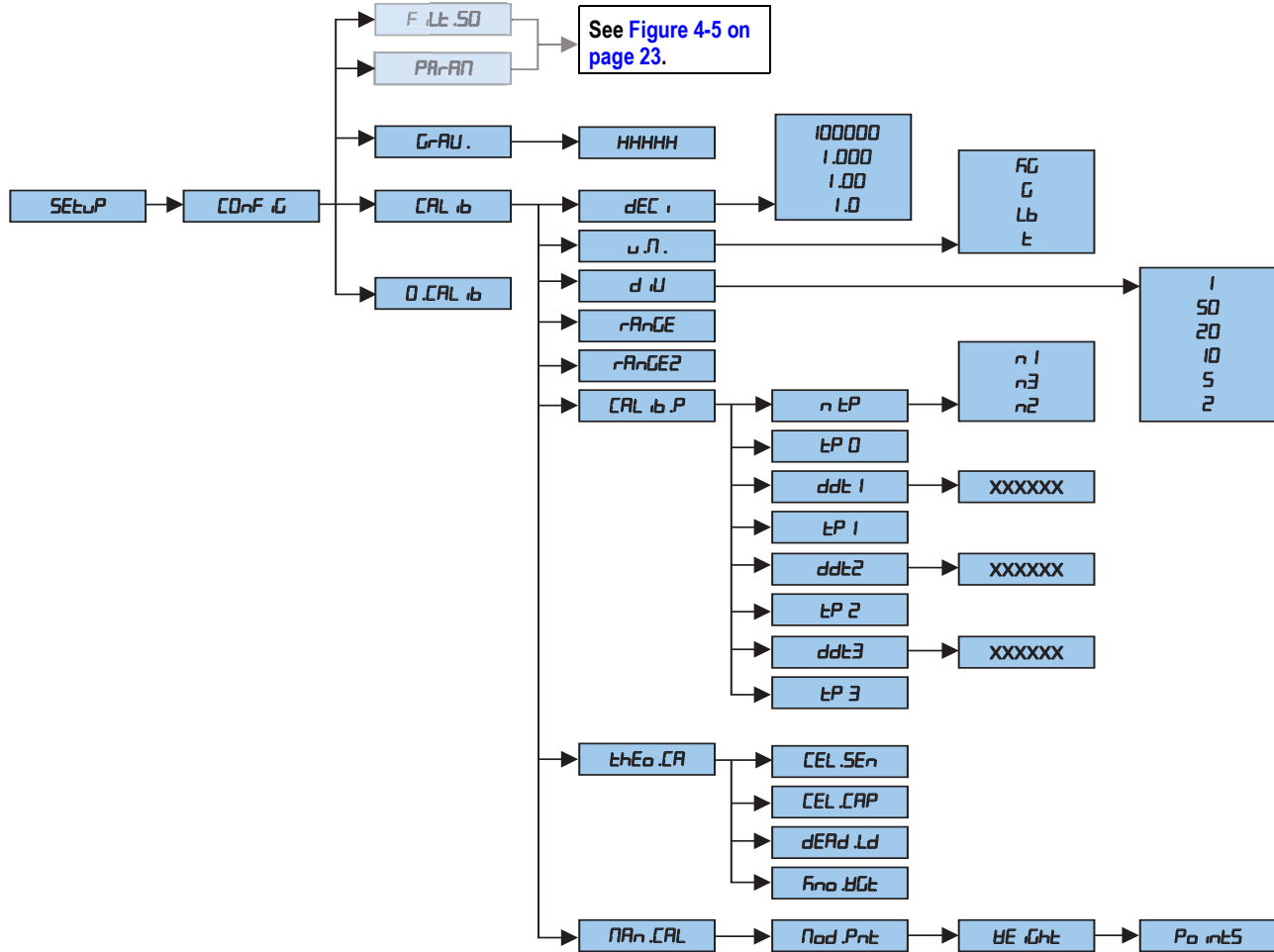

Figure 5-1. Calibration Menu

5.1.1 Calibration Parameters

Parameter	Settings	Description
GRAV	9.7500 1- 9.84999 default: 9.80665	Gravity acceleration – select the acceleration value of calibration location and installation location of the instrument; manual entry of the g value: the gravitational acceleration value may be manually entered; the minimum decimal value is 9.75001m/s ² ; any decimal number that is not between 9.75001 and 9.84999 m/s ² (inclusive), is incorrect.
dEC 1		Decimal Point Location – when combined with the decimal point location, specifies the location of the decimal point or dummy zero in the unit display. (1.0, 1.00, 1.000, 100000)
u.n.		Units – specifies units for displayed and printed weight; Lb, Fz, t, G; (lb is standard on legend; stickers are available for g, t, and kg)
d iD		Display Divisions – selects the minimum division size for the displayed weight. (1, 2, 5, 10, 20, 50)
rRnGE 1		Maximum weight for first range or interval (also sets scale capacity)
rRnGE 2		Maximum weight for second range or interval (also sets scale capacity)
CAL .b.P	Calibration	
	n tP	Number of calibration points
	tP 0	Set weight value of unloaded scale
	ddt 1	Enter weight value of first sample weight
	tP 1	Add first sample weight and set calibration point
	ddt 2	Enter weight value of second sample weight
	tP 2	Add second sample weight and set calibration point
	ddt 3	Enter weight value of third sample weight
tP 3	Add third sample weight and set calibration point	
thEd .CR	Theoretical Calibration	
	CEL .SEN	Cell sensitivity in mV/V (0 to 99.99999)
	CEL .CAP	Total load cell capacity in the configured unit of measure. (0 to 9999999)
	dERd .Ld	Weight of the scale structure on the load cells with no weights added
	hno .HGE	Known value of the existing product that is not part of the dead load (0 to scale capacity)
MAN .CAL	Manual Calibration - manually change the weight and ADC value of calibration points	
	nod .Pnt	Select calibration point to change
	HE .Ght	Enter or confirm weight value
	PD .ntS	Enter or confirm ADC value
0 .CAL .b		Performs a zero calibration

Table 5-1. Calibration Parameters



Note In the case that a number needs to be entered to set a parameter, press **▶** to select the digit to be modified and **▼** or **▲** to increase or decrease the digit.

To navigate a menu to select an option, Press **▼** or **▲**.

5.2 Calibration Procedure

Use this procedure to calibrate the scale.

1. Navigate to **SEtUP** → **CONF** → **iD** → **CAL .b** → **dEC 1**. Press **←** to set parameter.
2. Navigate to select the decimal place value. Press **←** to confirm selection. **u.n.** displays. Press **←** to set parameter.



Note By setting the divisions of the first range, the divisions for the second range are automatically set.

3. Navigate to select the unit of measure. Press **←** to confirm selection. **d iD** displays. Press **←** to set parameter.
4. Navigate to select the scale's minimum division, or the first range of dual range. Press **←** to confirm value. **rRnGE 1** displays. Press **←** to set parameter.
5. Set the total capacity of the scale, or **rRnGE 1** if using multi-range functioning. Press **←** to confirm. See [Section 3.2 on page 12](#) for more information on multi-range functioning.

6. For dual range scale only:
 - Navigate to select $rRnGE2$. Press \leftarrow to set parameter.
 - Set the second range. Press \leftarrow to confirm. $CAL ib.P$ displays. Press \leftarrow to enter the menu. nEP displays. Press \leftarrow to set parameter.



Note *The $rRnGE2$ is disabled if set at 000000. See Section 3.2 on page 12 for more information on multi-range functioning.*

7. Navigate to select the desired number (1-3) of calibration points and press \leftarrow . $tP 0$ displays. Press \leftarrow .
8. Unload the scale and wait until $ddt 1$ displays. Press \leftarrow .
9. Set the weight value of first sample weight. Press \leftarrow to confirm.
10. Navigate to select $tP 1$. Press \leftarrow .
11. Put the weight on the scale. Press \leftarrow . Wait until the display stops flashing between the scale counts and $tP 1$.



Note *When the weight acquisition is complete and a calibration point is set, the internal divisions value momentarily displays followed by nEP . If using multiple calibration points, the unit automatically advances to the next point ($ddt2, ddt3$).*

12. Repeat step 4-11 for each calibration point.



Note *The calibration points must be in increasing order (point 1 < point 2 < point 3).*

13. Remove all weight from the scale. This step is optional, however, be aware if the auto-zero function is active, after saving the calibration the weight on the scale displays as zero even if the weight has not been removed. See $SEtUP \rightarrow CONF \rightarrow PARAN \rightarrow AUTO-0$ in Table 4-5 on page 24.
14. Once the calibration is complete, press C until the instrument displays $SAVEP$.
15. Press \leftarrow to confirm and store the calibration to the instrument memory, $STORE$ displays; press any other key to cancel and exit without saving.

5.3 Theoretical Calibration

Use a theoretical calibration when a weight of known value is not available, or a manual calibration cannot be performed.

1. Restart indicator. Momentarily press \blacktriangle during startup to display setup mode.
2. Navigate to $SEtUP \rightarrow CONF \rightarrow CAL \rightarrow dEC 1$. Press \leftarrow to set parameter.
3. Navigate to select the decimal place value. Press \leftarrow . $.u.n$ displays. Press \leftarrow to set parameter.



Note *By setting the divisions of the first range, the divisions for the second range are automatically set.*

4. Navigate to select the unit of measure. Press \leftarrow to confirm selection. $d.u$ displays. Press \leftarrow to set parameter.
5. Navigate to select the scale's minimum division. Press \leftarrow . $rRnGE 1$ displays. Press \leftarrow to set parameter.
6. Set the total capacity of the scale, or $rRnGE 1$ if using multi-range functioning. Press \blacktriangleright to select the digit to be modified and \blacktriangledown or \blacktriangle to increase or decrease the digit. Press \leftarrow to confirm.
7. For dual range scale only:
 - Navigate to select $rRnGE2$; press \leftarrow to set parameter
 - Set the second range; Press \leftarrow to confirm



Note *See Section 3.2 on page 12 for more information on multi-range functioning. The $rRnGE2$ is disabled if set at 000000; for more information on multi-range functioning.*

8. Navigate to select $tHEO.CA$. Press \leftarrow to enter the menu. $CEL.SEN$ displays. Press \leftarrow to set parameter.
9. Set the cell sensitivity in mV/V. Press \leftarrow to confirm. $CEL.CAP$ displays. Press \leftarrow to set parameter.



Note *If several load cells are connected through a junction box enter the average sensitivity value of the cells.*

10. Set the total load cell capacity in the configured unit of measure. Press **←** to confirm. *dERd .Ld* displays. Press **←** to set parameter.
11. Enter the known weight of the scale structure dead load on the load cells with no weights added. Press **←** to confirm. *Fno .BGE* displays. Press **←** to set parameter. *GET .BEP* displays.

**Note**

The first character indicates the sign: 0 indicates a positive value, - indicates a negative value.

The sign is changed by positioning on the first digit and pressing ▼ or ▲:

- 4 decimals: from -9.9999 to 9.9999
- 3 decimals: from -99.999 to 99.999
- 2 decimal: from -999.99 to 999.99
- 1 decimals: from -9999.9 to 9999.9
- Enter 000000 if the value is not known

12. Enter the known value in the configured unit of measure. Press **←** to confirm.
13. If the weight is unstable, *Er .nEt* may momentarily display, then *StoREP* displays.
 - Press **←** to confirm and save and proceed to step 13
 - Press **C** for next confirmation. *rERYP* displays; press **←** to confirm and repeat the operation

**Note**

By setting the value to zero, the dead load is acquired.

14. Press **C** to exit the calibration. *th .ERLP* displays.
 - Press **←** to confirm and apply the new calibration
 - Press **C** to cancel

Repeat this procedure for each connected scale.

5.4 Setting Local Gravity

Use this procedure to correct the weight error caused by a different gravitational value between the calibration zone and the zone of use.

1. Calibrate the indicator.
2. Restart indicator. Momentarily press ▲ during startup to display setup mode.
3. Navigate to *SEtUP* → *ConF* → *GRAV*. Press **←** to set parameter.
4. Enter the local gravity. Press **←**. Default is 9.80390.
5. Slowly press **C** multiple times to exit the menus until *SRUEP* displays.
 - Press **←** to confirm and return to the weigh mode
 - Press any other key to cancel and exit without saving

The weight error caused by a different gravitational value between the calibration zone and the zone of use is automatically corrected.

Press and hold ▼ when turning on the instrument. The g value relative to the gravitation zone of the user displays for a few seconds, after the name and the installed software version.

**Note**

To find the local gravity, enter the latitude and elevation into the International Gravity Formula.

Listed are links to websites that can be used to determine local latitude and altitude. Please note these website address are provided for reference only and may change.

Map Coordinates uses Google maps to find latitude and elevation: www.mapcoordinates.net/

Once local latitude and altitude have been determined, use the following link to calculate local gravity <http://www.sensorsone.com/local-gravity-calculator/>

IMPORTANT

The gravity correction function has not been evaluated by an approvals agency, therefore it is up to the authorized scale dealer to ensure the device is accurate at the intended point of use.

5.5 Zero Dead Load A/D Counts

Table 5-2 lists the ideal A/D counts that result from input signals of 0 to 15 mV with zero deadload. Actual values will typically be higher than the values shown in Table 5-2 but the ideal values can be used when calibrating the indicator with no attached scale.

Input Signal (mV)	Raw A/D Count
0	1830
2.5	543564
5.0	1085373
7.5	1627166
10	2168897
12.5	2710715
15	3252467

Table 5-2. Ideal A/D Raw Counts

6.0 Communications

6.1 Serial Outputs

The instrument has two bidirectional serial outputs which are ASCII code compatible with most printers, remote displays, PCs and other devices. See [Section 2.7 on page 8](#) for connection information.

Transmission of data through the serial ports can be configured in the parameters *PCSEL*, *PCModE* and *PrModE* in the setup mode. See [Section 6.2 on page 38](#).

6.1.1 COM1 Serial Port

The COM1 serial port is bi-directional (half duplex) and uses RS-485 for transmitting data. It is mainly used to connect PCs, PLCs and additional remote displays. The transmission speed may be selected in the setup as: 1200, 2400, 4800, 9600, 19200, 38400, 57600, 115200 baud (bit/sec).

On the same RS-485 line, it is possible to connect up to 32 devices (RS-232 instruments can use an RS-485/RS-232 signal converter).

Considerations when making RS-485 connections:

- Use a Shielded Twisted Pair cable to make the connection (twisted and shielded pair(s) with single shielding for each pair through aluminum band and total shielding through external shielding)
- Using 24 AWG duplex cable with external shielding, the RS-485 cable should not exceed 4000' (1200 m); See [Section 2.3 on page 5](#)
- With very long cables, cable capacity becomes a dominant factor in power consumption (normally near 50pF/m); cable capacity decreases as length increases; capacity also decreases when speed is increased; the maximum distance cannot be covered with the maximum possible speed

Baud Rate (bit/sec)	Total Cable Capacity (pF)
1200	400000
2400	200000
4800	100000
9600	50000
19200	25000
38400	12000
57600	8000
115200	4000

Table 6-1. Cable Capacity

- Verify single point grounding on all equipment; See [Section 2.4 on page 6](#)
- Use correct single point grounding to avoid forming ground loops
- On the RS-485 network, two termination resistances equal to the impedance of the cable (typically 120 Ω) are normally connected on the two devices at the ends of the cable; The terminal resistance is not supplied with the ports of the instrument
- Consult the device product data sheet for all connected devices to ensure consistent wire labeling

6.1.2 COM2 Serial Port

The COM2 serial port is bi-directional (full duplex) and uses an RS-232 for transmitting data. It is mainly used to connect printers, PCs, and PLCs. The transmission speed may be selected in the setup as: 1200, 2400, 4800, 9600, 19200, 38400, 57600, 115200 baud.

6.2 Serial Port Transmission Modes

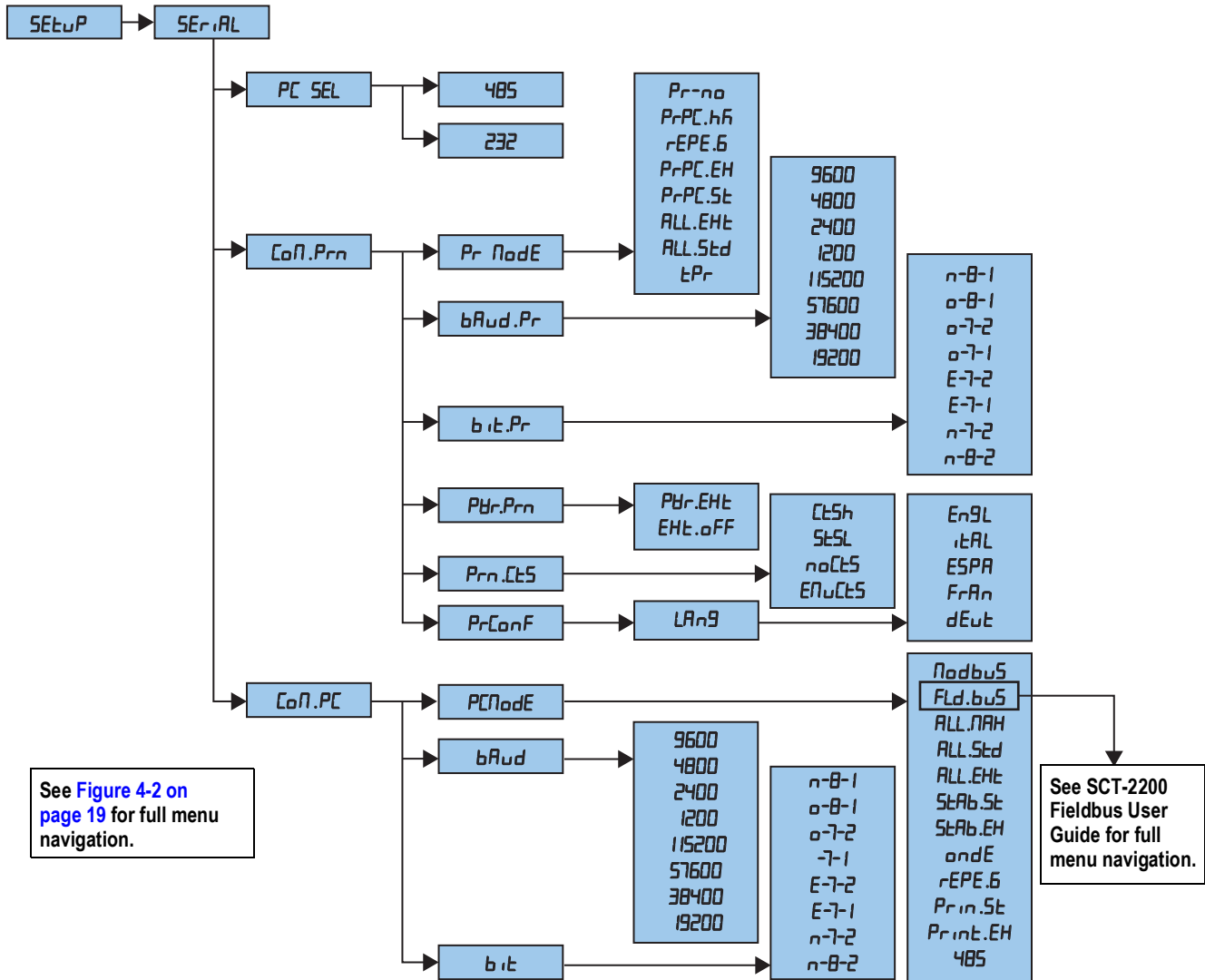

Figure 6-1. Serial Menu

6.2.1 PC Port Selection

It's possible to select the serial port to be used as a PC port. When a port is selected for PC port transmission, the other serial port is selected as default for PRN port transmission.

This setting is made in the SEtUP→SErIAL→PC SEL step.

Select the RS-485 serial port as the PC PORT and the RS-232 serial port sets as the PRN PORT.

Select the RS-232 serial port as the PC PORT and the RS-485 port sets as the PRN PORT.

Parameter	Settings	Description
PCSEL		Select the communication carrier for the ports
	485	Communication between the instrument and the PC takes place through the RS-485 port and transmission of data to the printer through the RS-232 port
	232	Communication between the instrument and the PC takes place through the RS-232 port and transmission of data to the printer through the RS-485 port

Table 6-2. PC Port Selection

6.2.2 PRN PORT

This section describes the selectable serial weight transmission modes of the PRN serial port through the parameter set in *PrModE*.



Parameter	Settings	Description
<i>Con.Prn</i>		Serial Format for the printer port
<i>PrModE</i>		Transmission to serial printer
	<i>PrNo</i>	Transmission disabled
	<i>PrPC.Hn</i>	Transmission of the weight string by pressing enter
	<i>rEPE.B</i>	The weight is displayed on the instrument and is transmitted to a 6 digit remote display
	<i>PrPC.EH</i> <i>PrPC.St</i>	<i>PrPC.EH</i> allows for transmission of the extended string by pressing enter See Section 6.4.2 on page 46 <i>PrPC.St</i> allows for transmission of the standard string by pressing enter See Section 6.4.1 on page 46 Transmission when  is pressed – the instrument transmits the weight data through the serial port when  is pressed; Transmission takes place if the weight is stable and the net weight is > 20 divisions; re-enabling the transmission depends on how <i>rERCLt</i> is set in the setup mode (passing by zero of the net weight, weight instability or always) Data is transmitted with the standard string <i>PrIn.St</i> or the extended string; See Section 6.4 on page 46 for a description of the strings; The transmission is confirmed when <i>tRn5n</i> displays
<i>ALL.EHt</i> <i>ALL.Std</i>	Continuous Transmission for interfacing to the PC, remote displays and other devices which request a constant stream of the data independently from the weight stability; the instrument transmits data with each A/D cycle: <ul style="list-style-type: none"> Baud rate at 9600 up to 10 transmissions per second are possible Baud rate at 115200 up to 16 transmissions per second are possible for the PC port and up to 12 for the printer port The data transmits both positive and negative values <ul style="list-style-type: none"> <i>ALL.Std</i> - The data is transmitted using the standard string <i>ALL.EHt</i> - The data is transmitted using the extended string - See Section 6.4 on page 46 for a description of the strings NOTE: Filter selection directly affects data transmission; To obtain 250TX/sec configure the filter F.F.400 (SEtUP → CONF IG → PR-AN . → StAb IL)	
<i>tPr</i>	Enables printing with ASCII compatible printer Data is transmitted to the printer by pressing  on the instrument; the print command is inhibited if the weight is in motion and in all other circumstances in which the data is not valid	
NOTE: In the <i>rEPE.B</i> protocol, the serial output is automatically set at 4800, N-8-1 but can be configured differently. For the protocol and transmission mode specifications, see Section 6.2 on page 38.		
<i>baud.Pr</i>		Set baud rate - selection of the data transmission speed (baud = bit/second); (9600 default)
<i>bit.Pr</i>		Set parity, word, stop bit
<i>PBr.Prn</i>		Manufacturer Use Only
<i>Prn.Ct5</i>		Manufacturer Use Only
<i>Pr.ConF</i>	<i>LRn9</i>	Select Language of Printouts NOTE: Language selection only available if <i>tPr</i> is selected

Table 6-3. PRN Port Parameters and Settings

6.2.3 PC PORT

This section described the selectable serial weigh transmission modes of the PC serial port.

Parameter	Settings	Description
<i>CoM.PC</i>		Serial format for the PC port
<i>PCModE</i>		Transmission on the PC port
	<i>Modbus</i>	Transmission with the MODBUS protocol <ul style="list-style-type: none"> • <i>Mod.tYP</i> displays; press ←; select <i>ASC II</i> or <i>RTU</i>; press ← • <i>Mod.Addr</i> displays; press ←; enter the address of the unit (0 to 98); press ← • Enter baud rate; press ← • Enter bit parameters; press ←
	<i>Fldbus</i>	Fieldbus type; See SCT-2200 Fieldbus User Manual for more information; PN183523 <ul style="list-style-type: none"> <i>Profibus</i> - Profibus <i>EtherIP</i> - Ethernet/IP <i>Profinet</i> - ProfiNet <i>EtherCat</i> - EtherCat <i>CANopen</i> - CANopen <i>DeviceNet</i> - DeviceNet <i>Modbus TCP/IP</i>
	<i>ALL.NAH</i> <i>ALL.Std</i> <i>ALL.Ext</i>	Continuous Transmission for interfacing to the PC, remote displays and other devices which request a constant stream of the data independently from the weight stability; the instrument transmits data with each A/D cycle: <ul style="list-style-type: none"> • Baud rate at 9600 up to 10 transmissions per second are possible • Baud rate at 115200 up to 16 transmissions per second are possible for the PC port and up to 12 for the printer port The data transmits both positive and negative values <ul style="list-style-type: none"> • <i>ALL.Std</i> - The data is transmitted using the standard string • <i>ALL.Ext</i> - The data is transmitted using the extended string <ul style="list-style-type: none"> - See Section 6.4 on page 46 for a description of the strings • <i>ALL.NAH</i> The weight is transmitted in hexadecimal format (for example: 03E8= 1000g), without decimal point <ul style="list-style-type: none"> - This transmission protocol is recommended for applications where a high number of output transmissions is required. (up to 250TX/sec. with baud rate equal to 115200) <p>NOTE: Filter selection directly affects data transmission; To obtain 250TX/sec configure the filter F.F.400 (SEtUP → CoNF IG → PArAM . → SEtB IL)</p>
	<i>SEtB.St</i> <i>SEtB.Ext</i>	Transmission on stability – each time a weight on the scale becomes stable, a communication string is transmitted on the PC port; <ul style="list-style-type: none"> • The transmission takes place when the weight is stable and the net weight is greater than 10 display divisions • Re-enabling the transmission depends on how <i>rERct</i> has been set in the setup mode; See Table 4-2 on page 20 • The data is transmitted with the standard string <i>SEtB.St</i> or the extended string <i>SEtB.Ext</i>; See Section 6.4 on page 46 for a description of the three strings
	<i>ondE</i>	Transmission requested on demand, from an external device – the instrument waits for a command before transmitting data; See Section 6.3 on page 41 With baud rate at 9600, up to 10-11 requests per second are possible through the READ command; with baud rate at 115200, up to 16 requests per second are possible through the READ command; The data transmits both positive and negative values
	<i>rEPE.B</i>	Transmission to 6 digit remote display / Reception of the “ <i>rEPE.B</i> ” string The weight display occurs both in the instrument and is transmitted to a 6 digit remote display

Table 6-4. PC Port Parameters and Settings

Parameter	Settings	Description
PC ModE	Pr in.St Pr in.Eh	The instrument communicates the weight data through the serial port when  is pressed <ul style="list-style-type: none"> Transmission takes place if the weight is stable and the net weight is > 20 divisions; re-enabling transmission depends on how the rERLc is set in the setup mode (passing by zero of the NET weight, weight instability or always) Pr in.St - The data is transmitted using the standard string Pr in.Eh - The data is transmitted using the extended string <ul style="list-style-type: none"> - See Section 6.4 on page 46 for a description of the strings The transmission is confirmed when t-R-R-S-N displays
	485	Transmission in RS-485 serial mode; Protocol mimics the command that was sent; the instrument responds only if its ID is the one requested (before the request the module ID must be input, i.e. 00READ<CRLF>); If a broadcast address command (99) is received no answer is given; If the command is correct it is executed
baud	Set baud rate - selection of the data transmission speed (baud = bit/second)	
bit	Set parity, word, stop bit	

Table 6-4. PC Port Parameters and Settings (Continued)

6.3 Serial Commands Format

Several characters are regularly used in serial commands. They are:

Characters	Description
[CC]o<ll>	Instrument ID, e.g. 00 (The ID is only used with RS-485 protocol)
<CR LF>	Carriage Return plus Line Feed (ASCII character 13 and 10)
<ESC>	ASCII character 27
<STX>	ASCII character 02
B	Space character, ASCII character 32

Table 6-5. Serial Command Legend

Serial Errors

The instrument transmits a response string or it transmits one of the following responses with each serial command received:

Status Response	Description
OK<CR LF>	Displays when a correct command is transmitted from the PC to the instrument; the OK does not imply that the instrument executes the zero
ERR01<CR LF>	Displays when a correct command is transmitted from the PC to the instrument, but the command is followed by unexpected letters; for example READf, TAREs instead of READ, TARE
ERR02<CR LF>	Displayed when a correct command is transmitted from the PC to the instrument, but contains wrong data
ERR03<CR LF>	Displayed when an incorrect command is received; when the command may not be used in the selected functioning mode; or when the command is received while the keyboard buffer is already full
ERR04<CR LF>	Displayed when a nonexistent command is received

Table 6-6. Serial Status Response



Note The instrument does not transmit a response with momentary commands; for example, those made up of only one letter and then the parameter.

Version Reading Command

[CC]VER<CR LF>

Instrument response: [CC]VER,vv,DGT1Sbbb<CR LF>

In which:

- vv is the firmware version
- b is the space character, ASCII 32



Note Instrument responds if the command has been received. No response is sent when the instrument has executed the command.

Extended Weight Read Command

[CC]REXT<CR LF>

Instrument response: extended string, See [Section 6.4.2 on page 46](#)

Weight Read Command

[CC]READ<CR LF>

Instrument response: standard string, See [Section 6.4.1 on page 46](#)

Weight Reading Command With Sensitivity Times 10

[CC]GR10<CR LF>

Instrument response: standard string, See [Section 6.4.1 on page 46](#)

Reading Command of MicroVolts Relative to the Weight

[CC]MVOL<CR LF>

Instrument response: standard string, See [Section 6.4.1 on page 46](#)

Reading Command of A/D counts Relative to the Weight

[CC]RAZF<CR LF>

Instrument response: standard string, See [Section 6.4.1 on page 46](#)

Tare Command

[CC]TARE<CR LF> or [CC]T<CR LF>

Instrument response: [CC]OK<CR LF>

Zero Command

[CC]ZERO<CR LF> or [CC]Z<CR LF>

Instrument response: [CC]OK<CR LF>

Clear Command

[CC]CLEAR<CR LF> or [CC]C<CR LF>

Instrument response: [CC]OK<CR LF>

The command also works in the setup mode.

Test Command

[CC]ECHO<CR LF>

Instrument response: [CC]ECHO<CR LF>

Print Command

[CC]PRNT<CR LF> or [CC]P <CR LF>

Instrument response: [CC]OK<CR LF> if the command has been received, no answer for the P command.

Tare Insertion Command

[CC]TMANVVVVV<CR LF> or [CC]WVVVVV <CR LF>

In which: VVVVVV is the manual tare value with the decimal point, from 1 to 6 characters; the non significant zeros can be omitted.

Instrument response: [CC]OK<CR LF> if the command has been received; no answer for the W command.

Command for Displaying Temporary Message on an Instrument

[CC]DISPNNVVVVV <CR LF>

In which:

- NN is the instrument display number, standard 00 (ASCII hex)
- V is the message:
 - if present, it is shown on the NN display
 - if not present, the command interrupts the possible visualization enabled with a previous DISP command, restoring the visualization of the weight data



Note

If the display shown in the command is numeric (for example the standard display 00) and in the transmitted message there are two consecutive points, the message is stopped after the first of the two points. When the display is showing a message transmitted serially through the DISP command, the instrument does not display those messages usually shown in the scale status (ZERO, TARE, HOLD, etc.).

Instrument response: [CC]OK<CR LF>

The message remains for the time set through the DINT command

The ASCII characters having the decimal code greater than 31 are accepted.

Command for Setting Display Message Interval

[CC]DINTNNNN<CR LF>

In which: NNNN is the visualization interval (in milliseconds), expressed in ASCII hex character; for example, in order to set a visualization time of 2 seconds (2000 milliseconds, which converted into hex it becomes 07D0), the command becomes [CC]DINT07D0<CR><LF>.

By setting a time equal to zero, the message transmitted with the DISP command remains permanently shown on the display.

Instrument response: [CC]OK<CR LF>

PC Confirmation Command

[CC]PCOK<CR LF>

The instrument shows on the display the *-PCOK-* message for about two seconds.

Instrument response: [CC]OK<CR LF>

Serial Command which Returns the Instrument Status

[CC]STAT<CR LF>

Instrument response: [CC]STATXX<CR LF>

In which: XX is a decimal value which returns the status of the instrument; the possible values are:

XX	Instrument Status
00	Normal scale status
01	Normal scale status in input
02	Instrument in technical setup
03	Instrument in boot phase
04	Instrument in rx/tx setup phase
05	Instrument in test phase of the serial ports
06	Instrument in print test
07	Instrument in firmware update phase
08	Instrument in standby
09	Instrument in automatic zero phase
10	Instrument in change channel
11	Instrument in inputs test phase

Table 6-7. Instrument Status Commands

Key Press Simulation Command

[CC]KEYPXX<CR LF>

In which:

XX	Code of Pressed Key
00	▼ - ZERO key
01	▲ - TARE key
02	▶ - MODE key
03	← - PRINT key
04	C - C key
05	Numeric 1 key
06	Numeric 2 key
07	Numeric 3 key
08	Numeric 4 key
09	Numeric 5 key
0A	Numeric 6 key
0B	Numeric 7 key
0C	Numeric 8 key
0D	Numeric 9 key
0E	Numeric 0 key

Table 6-8.

Instrument response: [CC]OK<CR LF>: accepted command.

In the event the simulated key has two linked functions, key momentarily pressed or pressed at length, if the KEYP command is followed by the release command (KEYR) within a maximum time of 1.5 seconds, the momentary key press is executed; otherwise the key pressed at length is executed.

Release Key Press Simulation Command

[CC]KEYR<CR LF>

Instrument response: [CC]OK<CR LF>



Note The instrument does not respond OK to the following momentary commands (P, Q, T, W, X, Z).

Read Scale Information

[CC]RALL<CR LF>

Instrument response:

[CC]SS,B,NNNNNNNUM,LLLLLLLUM,YYTTTTTTTUM,XXXXXXXXUM,SSS,AAA,CCC,TTT,XXXXX-YYYYYY<CR LF>.

In which:

Characters	Description
SS	UL Underload OL Overload ST Stability of the display US Instability of the display TL Active inclination input
B	Number of platform on which the totalization has been made
NNNNNNNUM	Net weight with unit of measure
LLLLLLLUM	Gross weight with unit of measure
YY	Tare Type; Blank spaces if semi-automatic tare; PT If preset tare
TTTTTTTUM	Tare value with unit of measure
XXXXXXXXUM	Not used

Table 6-9. Scale Information Characters

Characters	Description
SSS	Scale status <ul style="list-style-type: none"> • 000 Weighing • 001 Numeric value input • 002 Setup menu
AAA	Counter of pressed keys
CCC	Code of last key pressed
TTT	Not used
XXXXX	Last rewriting number stored in the alibi memory
YYYYYY	Last weigh number stored in the alibi memory

Table 6-9. Scale Information Characters (Continued)

Setpoint Command

[CC]STPTnxxxxxyyyyyy<CR LF>

In which: n indicates the setpoint number (1, 2)

t→F if the following weight value indicates that the setpoint will disable the outputs (OFF).

t→O if the following weight value indicates that the setpoint will enable the outputs (ON).

xxxxxx and yyyyyy represent the weight value of the setpoint that disables or enables the outputs: the digits must be entered without the decimal point, omitting the non-significant zeros.

Instrument responses: [CC]OK<CR LF> correct syntax and correct values have been received

[CC]NO<CR LF> correct syntax but wrong values have been received

Example of instrument with capacity 10.000 kg and division 1 g:

Command: **STPT1F5000O6500** (Disabling first output at 5 kg and enabling at 6.5 kg)

Instrument response: **OK**



Note

The ERR 02 code displays when:

One of the two entered values is greater than the capacity.

One of the two entered values has a minimum division that is inconsistent in comparison to the one set in the instrument.

The disabling value is greater than that of enabling.

The transmitted values are valid until the instrument is turned off. To permanently save these on the instrument use the saving command (CMDSAVE). To save various setpoints set all of them and at the end transmit the saving command.

Setpoint Saving Command

[CC]CMDSAVE<CR LF>

Response: [CC]OK<CR LF>

Enable/Disable Keyboard

To enable the keyboard: [CC]KEYEE<CR LF>

Instrument response: [CC]OK<CR LF>

To disable the keyboard: [CC]KEYED<CR LF>

Instrument response: [CC]OK<CR LF>

6.4 Transmission Protocols

The weight data transmission on the PC and PRN serial ports will take place in one of two formats: standard string or extended string.

6.4.1 Standard String

String transmitted: [CC]hh,kk,pppppppp,uu <CR LF>

In which:

Characters	Description
[CC]	The instrument ID as two ASCII decimal digits (RS-485 protocol)
hh	UL Underload OL Overload ST Stability of the display US Instability of the display
,	Comma character
kk	NT Net weight GS Gross weight GX Gross weight with sensitivity times 10 VL Value in microvolts relative to the weight RZ Value in converter points relative to the weight
pppppppp	8 digits (including sign and decimal point) which identify the weight; the insignificant digits are filled with spaces; through the MVOL and RAZF command the instrument transmits the relative value on 10 digits instead of 8
uu	Unit of measurement kg, bg, bt, lb, mv (microvolts), vv (A/D counts); (b signifies blank)
<CR LF>	Carriage Return + Line Feed (ASCII decimal character 13 and 10)

Table 6-10. Standard String Characters



Note The transmitted weight is gross weight (GS) if no tare weight has been entered; otherwise, net weight (NT) is transmitted.

6.4.2 Extended String

String Transmitted:

[CC]B,hh,NNNNNNNNNN,YYTTTTTTTTTT,PPPPPPPPPP,uu,(dd/mm/yybbhh:mm:ss|NO DATE TIME)<CR LF>

In which:

Characters	Description
[CC]	The instrument ID as two ASCII decimal digits (RS-485 protocol)
B	Scale number is always 1
,	Comma character
hh	UL Under load OL Overload ST Stability of display US Instability of display
NNNNNNNNNN	Net weight on 10 characters including possible sign and decimal point
YY	PT if the tare is manual, if YY = two empty spaces display with semiautomatic tare
TTTTTTTTTT	Tare weight on 10 characters including possible sign and decimal point
PPPPPPPPPP	Always 0
uu	Unit of measure Kg, bg, bt, lb; (b signifies blank)
<CR LF>	Carriage Return + Line Feed (ASCII decimal character 13 and 10)

Table 6-11. Extended String Characters



Note The non significant digits of the net, tare, and gross weights are filled with spaces (space characters, ASCII decimal 32 character).

6.4.3 Secondary Mode Strings

Secondary Standard String

Standard string transmitted on the print port when $Pr.NDdE = ALL.SEd$ or $Pr.PC.SE$; SS,NT,WWWWWWWWW,UU<CR LF>

In which:

Characters	Description
SS	Status: • NV Weight not valid
,	Comma character
NT	ST Stable data US Unstable data UL Underload OL Overload
WWWWWWWWW	Weight
UU	Unit of measure

Table 6-12. Secondary Mode String Characters

Secondary Extended String

Extended string transmitted on the printer port when $Pr.NDdE = ALL.EHt$ or $Pr.PC.EH$

C, SS,NT,WWWWWWWWW,UU<CR LF>

In which:

Characters	Description
C	Secondary or sum: • S, if the sum is sent
,	Comma character
SS	UL Underload (not transmitted in the TRANSM mode) OL Overload (not transmitted in the TRANSM mode) ST Stability of the display US Instability of the display
WWWWWWWWW	weight
UU	unit of measure

Table 6-13. Extended String Characters



When rEPE.E is selected the weight value is always zero.

When the $Pr.NDdE = Pr.PC.hh$ is set, only the weight is transmitted on the printer port.



7.0 Troubleshooting

Use the following table to troubleshoot error messages on the instrument.

Message	Description
<i>AL.Err</i>	Displays when not connected at start-up, if there are communication problems between the instrument and the board or when the alibi memory operation is selected; The unit of measure conversion is automatically set, but not saved in the setup mode
<i>bUSy</i>	Printing - PRN serial port is occupied or the instrument is waiting to transmit a print job to a PC
<i>unStAb</i>	Trying to print with an unstable weight
<i>un.OUEr</i>	Trying to print with the weight in underload or in overload; with a weight of 9 divisions greater than the capacity or 100 divisions below the gross zero
- - - - -	The weight is nine divisions above the maximum capacity
- - - - -	The weight is under the gross zero (- capacity - 9 divisions)
<i>Gross.Err</i>	Trying to print with a negative gross weight (equal or less than 0)
<i>net.Err</i>	Trying to print with a negative net weight (equal or less than 0)
<i>LoB</i>	Net weight less than the minimum necessary for the printing or the totalization
<i>no.O.unS</i>	Weight did not exceed net 0 or was not stable
<i>ConU.</i>	Trying to print while the instrument is converting the unit of measure
<i>no.in</i>	Second attempt to acquire the input weight (input/output mode, set as <i>in.out</i>)
<i>no.out</i>	Second attempt to acquire the output weight (input/output mode, set as <i>in.out</i>)
<i>no.1</i>	Second attempt to acquire the input weight (input/output mode, set as <i>G.t.</i> or <i>1St.2nd</i>)
<i>no.2</i>	Second attempt to acquire the output weight (input/output mode, set as <i>G.t.</i> or <i>1St.2nd</i>)
<i>PrEC</i>	Displays when trying to calibrate a point without first having confirmed the number of calibration points
<i>ErNot</i>	Weight is unstable during the acquisition of a point during calibration
<i>ErPnt</i>	During the acquisition of a calibration point a null value has been read by the converter
<i>Er-11</i>	Calibration error – the sample weight used was too small; use a weight equal to at least half of the scale capacity
<i>Er-12</i>	Calibration error – the acquired calibration point (<i>tP1</i> or <i>tP2</i> or <i>tP3</i>) is equal to the zero point (<i>tP0</i>)
<i>Er-37</i>	Scale must be calibrated; perform a technical default (<i>dEFFW</i>) parameter, before proceeding, See Table 4-3 on page 21 NOTE: Press ▲ to access the setup.
<i>Er-39</i>	Scale must be calibrated; perform a technical default (<i>dEFFW</i>) parameter, before proceeding, See Table 4-3 on page 21 NOTE: Press ▲ to access the setup.
<i>EcoH</i>	Displays momentarily if the secondary connects to primary X; if connection is not possible, the error message remains fixed and the secondary instrument emits an audible signal

Table 7-1. Error Messages

8.0 Compliance

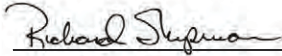
	EU DECLARATION OF CONFORMITY <i>EU-KONFORMITÄTSERKLÄRUNG</i> <i>DÉCLARATION UE DE CONFORMITÉ</i>		Rice Lake Weighing Systems 230 West Coleman Street Rice Lake, Wisconsin 54868 United States of America 
	Type/Typ/Type: SCT indicator series		
English	We declare under our sole responsibility that the products to which this declaration refers to, is in conformity with the following standard(s) or other regulations document(s).		
Deutsch	Wir erklären unter unserer alleinigen Verantwortung, dass die Produkte auf die sich diese Erklärung bezieht, den folgenden Normen und Regulierungsbestimmungen entsprechen.		
Français	Nous déclarons sous notre responsabilité que les produits auxquels se rapporte la présente déclaration, sont conformes à la/aux norme/s suivante ou au/aux document/s normatif/s suivant/s.		
EU Directive	Certificates	Standards Used / Notified Body Involvement	
2014/30/EU EMC	-	EN 61000-6-2:2015, EN 61000-6-4:2007+A1:2011, EN61326-1:2013, EN55011:2009 +A1:2010	
2014/35/EU LVD	-	EN 61010-1:2010	
2011/65/EU RoHS	-	EN 50581:2012	
Signature:			Place: <u>Rice Lake, WI USA</u>
Type Name:	<u>Richard Shipman</u>		Date: <u>May 3, 2019</u>
Title:	<u>Quality Manager</u>		

9.0 Specifications

Power DC

Power Supply	12-24 VDC
Power Consumption	70 mA min to 100 mA max
Excitation Voltage	5 VDC, 120mA, 8 x 350Ω
Analog Signal Input Range	±39 mV
Analog Signal Sensitivity	0..03 μV/gradation minimum 0.3 μV/gradation recommended

Operator Interface

Display	LED 6 digits 8mm high
Keypad	5-key, tactile feel
LED	6 status indicator red LEDs

Enclosure

Case	Plastic console suitable for mounting on DIN rail or on the wall
Dimensions (W x H x D)	0.98" x 4.52" x 4.72" (25mm x 115mm x 120mm)
Weight	1 lb (0.5kg)

Operation

Resolution Internal	1.5 million counts
Display Resolution	800,000 minimum
A/D Sample Rate	1 channel A/D 24-bit sigma-delta conversion; up to 200 conv./sec auto select
Tare Function	Entire capacity can be subtracted
Auto Switch Off	Programmable form 1—255 minutes

Communication

Digital Inputs/Outputs	
2 Inputs	Opto isolated 12-24 VDC
2 Outputs	150 mA 48 VAC/150 mA 60 VDC
Serial Ports	1 RS-485 bidirectional port configurable for connection to a PC/PLC or weight repeater 1 RS-232 bidirectional port for connection to a printer
Analog Output	Opto isolated, 16 bit 0-20 mA; 4-20 mA (max 350 Ω) 0-5 VDC, 0-10 VDC (min 10 Ω)

Optional Communication

Modules	PROFIBUS-DP, DeviceNet, PROFINET IO, Ethernet/IP, Ethernet TCP/IP, Modbus TCP/IP, EtherCAT, CANopen
---------	---

Environmental

Operating Temperature	5°F to 104°F (-15°C—40°C)
Storage Temperature	-22° to 179°F (-30°C—80°C)
Humidity	85% (non-condensing)

Load Cell

Connection	6-wires with Remote Sense
------------	---------------------------

Compliance

The SCT complies with Part 15 of the FCC Rules. Operation is subject to the following conditions:

- This device may not cause harmful interference.
- This device must accept any interference received, including interference that may cause undesired operation.



NTEP

CoC Number 20-046

Accuracy Class III/IIIL n_{max} : 10 000

Radio Certificate Number

When paired with optional module:

WiFi: US: ZXVHLK-RM04



© Rice Lake Weighing Systems Specifications subject to change without notice.
Rice Lake Weighing Systems is an ISO 9001 registered company.

230 W. Coleman St. • Rice Lake, WI 54868 • USA

U.S. 800-472-6703 • Canada/Mexico 800-321-6703 • International 715-234-9171 • Europe +31 (0)26 472 1319