

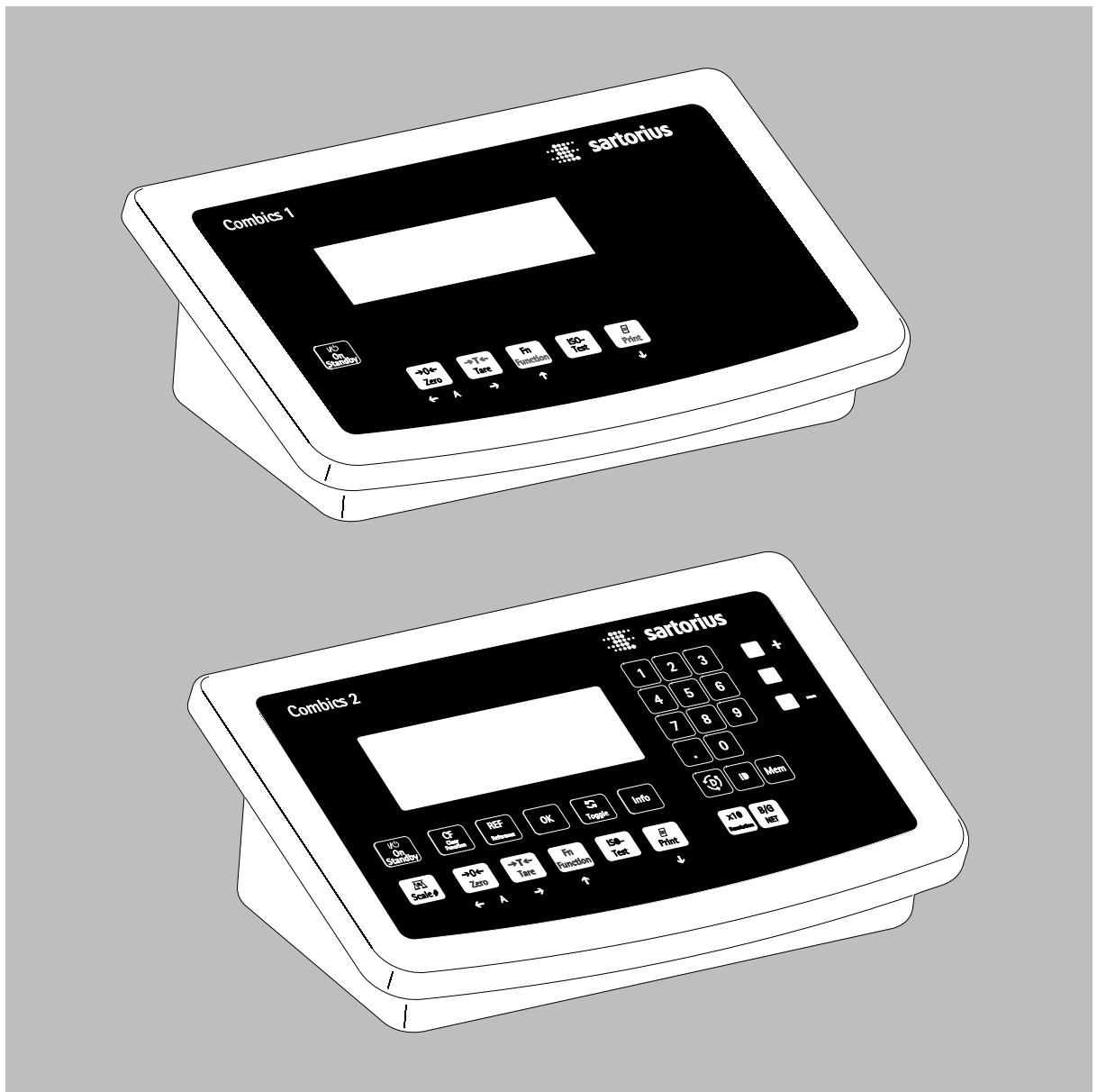







Operating Instructions

Sartorius Combics Series

Indicator Models CAISL1, CAISL2, CAIS1, CAIS2



Contents

Notes on Using this Manual	3	Data Interfaces	102
Warnings and Safety Precautions	4	Configuring the Data Interface as a COM Port (<i>DATPROT</i>)	105
Device Description	6	Data Input Format	106
Intended Use	6	Data Output Format	107
General View of the Equipment	7	Configuring the Data Interface as a Printer Port (<i>PRINTER</i>)	110
Installation	8	Configuring a Printout	110
Getting Started	9	GMP-compliant Printouts	111
Connect Weighing Platforms: Combics 1	11	Sample Printout	113
Connecting Weighing Platforms: Combics 2	12	Error Codes	115
Pin Assignment Chart	13	Care and Maintenance	116
Configuring Weighing Platforms	17	Service	116
Service Mode	17	Repairs	116
Analog/Digital Converter (ADC)	19	Cleaning	116
Entering Adjustment and Linearization Weights	26	Safety Inspection	117
Function Allocation of the  Key	26	Disposal	118
External Linearization	27	Specifications	119
Setting the Preload	28	Device Dimensions	121
Clearing the Preload	29	Accessories	122
Adjustment Without Weights	30	Documents List	125
Operating Design	31	Sartorius Services	125
Turning on the Device	31	Declarations of Conformity	126
Menu Operating Design	35	EC Type-Approval Certificate	129
Configuration	37	Test Certificate	130
Setting up Password Protection	38	Plates and Markings	131
Operation	40	Menu Structure	135
Weighing	40	Index	153
Calibration, Adjustment	47	Appendix:	
SQmin Function	50	Guide to Verification of Weighing Instruments	155
Data ID Codes	51	Appendix: General Password	157
Application Programs	53	Ex-Safety Information	160
Counting  (Combics 2):	54		
Neutral Measurement  (Combics 2)	59		
Averaging (Animal Weighing)  (Combics 2)	63		
Weighing in Percent % (Combics 2)	67		
Checkweighing  (Combics 2)	72		
Classification  (Combics 2)	80		
Totalizing  (Combics 2)	85		
Net Total Formulation  (Combics 2)	89		
Combining Application Programs	93		
Configuring Printouts	96		
Product Data Memory (Combics 2)	100		

Notes on Using this Manual

- ▶ Please read this entire manual carefully and completely before using the device.
- ▶ Read the safety precautions carefully.
- ▶ This manual is part of the product. Keep it in a safe and easily accessible location.
- ▶ If the manual should be lost or misplaced, please contact Sartorius for a replacement or download the latest manual from our website: www.sartorius.com

Symbols and Signs

The following symbols are used in this manual:



Warning symbol for various types of dangers. These symbols are explained in more detail in Section “Safety Instructions.”



This symbol indicates useful information and tips.



Dieses Symbol kennzeichnet Hinweise für den eichpflichtigen Verkehr im Gültigkeitsbereich der EG-Richtlinie 2009/23/EG.



This and similar symbols mean that the respective key should be pressed.



...

This means that this key must be pressed more than once.

- ▶ Indicates a required action
- ▷ Describes the result of an action
- 1. If a procedure has multiple steps...
- 2. ... the steps are numbered consecutively.
- Indicates an item in a list

Menu Descriptions

In some cases, text descriptions are used to describe menu settings and in other cases only the number structure of the menu is used for faster orientation for experienced users (e.g. “Menu item 1.9” contains the parameter settings for calibration/adjustment). The Setup menu is shown on the display when “COBES” is selected as the language (see “Configuration” starting on page 37).



Technical advice/Hotline:

Phone: +49.551.308.4440

Fax: +49.551.308.4449

Warnings and Safety Precautions

Combics indicators comply with the European Council Directives as well as international regulations and standards for electrical equipment, electromagnetic compatibility, and the stipulated safety requirements. Improper use or handling can, however, result in damage and/or injury.

- Read these operating instructions carefully before use.
This will prevent damage to the equipment.



The protective conductor must not be disconnected for any reason. Use only standard cables that have protective grounding conductors.



If there is visible damage to the equipment or power cord: unplug the equipment and secure it against further use.



Make absolutely sure to unplug the indicator from power before you connect or disconnect any electronic peripheral devices to or from the interface port.



The device should only be opened by personnel trained in accordance with Sartorius guidelines.



If you use electrical equipment in installations and under ambient conditions requiring higher safety standards, you must comply with the provisions as specified in the applicable regulations for installation in your country.



The operator shall be responsible for any modifications to the equipment and for any connections of cables or equipment not supplied by Sartorius and must check and, if necessary, correct these modifications and connections. Information on operational quality is available upon request from Sartorius (in line with norms pertaining to immunity).



Do not expose the equipment to aggressive chemical vapors or to unnecessarily extreme temperatures, moisture, shocks, or vibration.



Only clean the device as stipulated in the cleaning instructions: Refer to the “Care and Maintenance” chapter.



The display value can be affected by extreme electromagnetic influences. Once the disturbance has ceased, the instrument can be used again in accordance with its intended purpose.

Danger of Explosion!



Do not use this equipment in hazardous areas.

Installation



Warning when using pre-wired RS-232 connecting cables: RS-232 cables purchased from other manufacturers often have pin assignments that are incompatible with Sartorius products. Be sure to check the pin assignments against the chart in this manual before connecting the cable, and disconnect any lines identified differently from those specified by Sartorius.



Connect only Sartorius accessories and options, as these are optimally designed for use with your device. Therefore, do not use any proprietary solutions. The operator shall be solely responsible for installation and testing of any modifications to Sartorius equipment, including connection of cables or equipment not supplied by Sartorius. Information on operational quality (in line with norms pertaining to immunity) is available on request.

- ▶ If you have any problems with your device, contact your local Sartorius office, dealer or service center.

IP Protection Rating

- IP Rating:
- All models are rated to IP44 (IP65 as an accessory).
 - “IP65” models are rated to IP65.
 - The IP65/IP69K protection rating is ensured only if the rubber gasket is installed and all connections are fastened securely (including the caps on unused sockets). Weighing platforms must be installed and tested by a certified technician.
 - If you install an interface port or battery connection after setting up your indicator, keep the protective cap in a safe place for future use. The cap protects the interface connector from vapors, moisture and dust or dirt.



Use in Legal Metrology

- When the indicator is connected to a weighing platform and this equipment is to be verified, ensure that the applicable regulations regarding verification are observed.
- When connecting Sartorius weighing platforms, observe the permitted weighing range as listed in the “Guide to Verification of Weighing Instruments” and the Declaration of Conformity.
- A sticker with the “Sartorius” logo was affixed to the indicator as a control seal following verification. This seal will be irreparably damaged if you attempt to remove it. This will nullify the verification’s validity. In this case, re-verification would be required in compliance with all relevant national regulations and laws.

Device Description

Combics indicators:

- Are robust and durable, thanks to their stainless steel housing
- Are easy to clean and disinfect
- Are easy to operate, thanks to the following features:
 - Large, backlit display elements (14 segments)
 - Large keys with positive click action
- Can be operated independently of the weighing platform location
- Have a range of interfaces for flexible use
- Have optional password protection for operating parameters

Combics 1 offers these practical functions:

- Easy calibration via a separate key
- Automatic tare for loading
- Alibi memory connection option available
- Internal rechargeable battery
- Automatic printing for loading
- Configurable printout
- Flex print

Combics 2 speeds up your routine procedures with:

- Integrated programs for applications (some can be combined):
 - Counting
 - Neutral measurement
 - Averaging (animal weighing)
 - Weighing in percent
 - Checkweighing
 - Classification
 - Totalizing
 - Net-total formulation
- Automatic initialization when the scale is switched on
- Automatic taring when a load is placed on the weighing platform
- Can be controlled via two external computers using various protocols
- Barcode scanner connection option for entering tare value or IDs (6 units)
- Possibility to input tare values via the number block
- LED for measurement range identification
- Connection option for a second weighing platform
- Alibi memory
- Internal rechargeable battery
- Product data memory
- Configurable printout
- Flex print

Intended Use

Combics 1 and 2 indicators are robust indicators for daily quality control in industrial applications. They were designed for suitable scales or weighing platforms that correspond to the described technical specifications. Any other use beyond this is considered improper.

General View of the Equipment

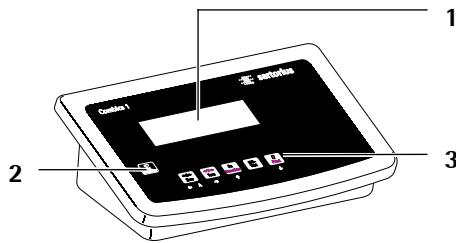

Combics 1 and 2

- 1 Display (for a detailed diagram, please see the chapter “Operating Design”)
- 2 On/Off key
- 3 General function keys: Zero, Tare, Switch function, Adjustment/Calibration, Print/Data output (see “Operating Design”)

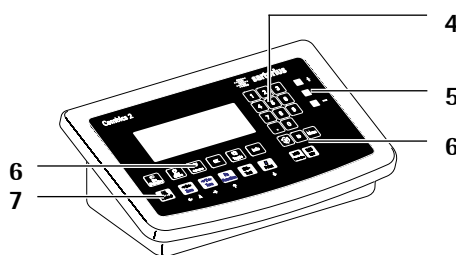

Combics 2 only

- 4 10 digit keypad for entering values
- 5 LEDs (for checkweighing and classification)
- 6 Additional function keys (see “Operating Design”)
- 7 Toggle between weighing platforms (WP)

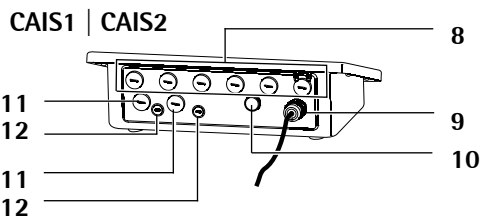

Back

- 8 Connection options for
 - COM1 standard
 - 2nd UNICOM interface for additional, optional functions (e.g. Ethernet, profibus etc.)
 - CAIS2: a barcode scanner can be connected via a terminal block
- 9 Power cord with country-specific plug
- 10 Vent valve: 1.5 Nm
- 11 Weighing platform WP-1 and/or WP-2 connection
- 12 Input for menu access switch (standard or legal-for-trade mode) for WP-1 and/or WP-2
- 13 RS232C interface “COM1” (standard)
- 14 Second “UNICOM” interface (Combics 2 only)
- 15 Combics 2 only: PS/2 connection (barcode scanner, external keypad)

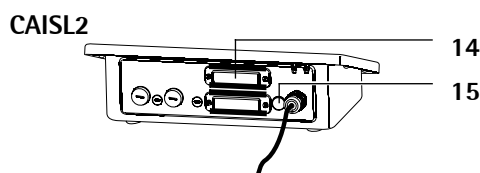
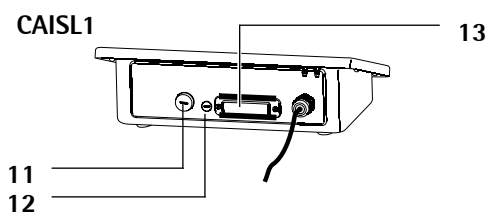

Installation

When a Combics indicator is ordered with special equipment, the desired options come pre-loaded from the factory.

Storage and Shipping Conditions



Once the equipment has been removed from the packaging, it may lose accuracy if subjected to strong vibration.

-
- Do not expose the equipment to unnecessarily extreme temperatures, moisture, shocks, blows or vibration.
 - Permissible storage temperature: -10°C to $+40^{\circ}\text{C}$

Installation Location

Avoid adverse influences at the place of installation:

- Extreme temperatures (operating temperature: -10°C to $+40^{\circ}\text{C}$)
- Aggressive chemical vapors
- Extreme moisture (according to IP protection class)

Unpacking

- ▶ After unpacking the device, check it for any visible damage as a result of rough handling during shipment.
- ▷ If you detect any damage, proceed as directed in the chapter entitled "Care and Maintenance" under "Safety Inspection."
- ▶ Save the original packaging for any future transport.
Unplug all connected cables before packing the equipment.

Checking Package Contents

- Indicator
- Operating instructions
- Options (special accessories) as listed on the bill of delivery

Acclimatizing the Device

Condensation can form on the surfaces of a cold device when it is brought into a substantially warmer area.

- ▶ Allow the device to acclimatize for about 2 hours at room temperature, leaving it unplugged from AC power.

Connecting Weighing Platforms (see Getting Started)



Make absolutely sure that the device is unplugged from the power supply before connecting/disconnecting any peripheral device (printer, PC) to or from the data interface.

Getting Started

- Steps**
- 1.) Connect weighing platform to the indicator.
 - 2.) Configure the analog/digital converter (ADC): see page 19
 - 3.) Carry out an alignment: for adjustment, see page 26, for linearization see page 27
 - 4.) Connect peripheral devices, e.g. printer to the COM1 or UNICOM interface: see Data Interfaces chapter starting on page 102

Connecting Weighing Platforms to WP1

An analog Sartorius platform (CAPP, CAPS, IU or IF) or a commercially-available DMS load cell can be connected to the Combics indicator WP1 input.



The load cell should be connected by a certified technician who has received specialized training from Sartorius. Any installation work that does not conform to the instructions in this manual results in forfeiture of all claims under the manufacturer's warranty.



Peripheral devices should be connected by a certified technician who has received specialized training from Sartorius. Any installation work that does not conform to the instructions in this manual results in forfeiture of all claims under the manufacturer's warranty.



Disconnect the equipment from the power supply before starting connection work.

- ▶ Set up the weighing platform (see Operating Instructions for the weighing platform)
- ▶ Place the cable from the weighing platform next to the indicator
- ▶ Open the Combics indicator:
Loosen the ten cap nuts on the front panel. Remove the front panel.

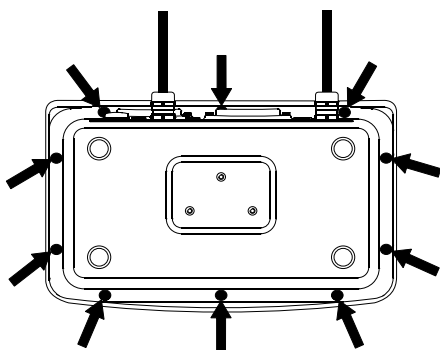

Installing Connection and Interface Cables



The cable gland (IP69K protection) is pre-mounted on the indicator. Please use extreme caution when performing any work on the equipment that affects this cable gland.

You must use a torque wrench to tighten the cable gland to 5 Nm.

Preparing Cables



- ▶ Strip approx. 14 cm from the end of the cable.
- ▶ Shorten the shielding to approx. 2 cm and pull back over the insulation.
- ▶ Strip approximately 5 mm of the insulation from the wires of the connecting cable and affix ferrules to the wire ends.

Attaching the Cable Entry



Please use extreme caution when performing any work on the equipment that affects this cable gland.

You must use a **torque wrench** to tighten the cable gland to 5 Nm.

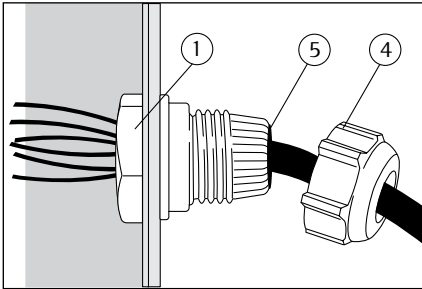

- ▶ Remove the protective cap from the bore hole on the indicator.
- ▶ Insert the included cable gland through the bore hole and secure from the inside using the locknut (1).

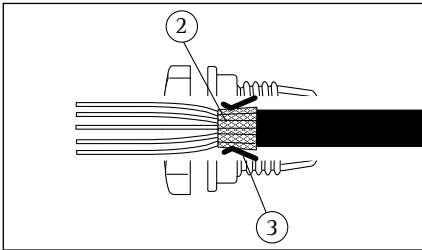

- ▶ Insert the cable through the cable gland until the shielding (2) comes into contact with the clamps (3). Tighten the screw-down nut (4) until the gasket (5) inserted between the screw-down nut and cable forms a small beaded rim.
- ▶ Check the shielding and clamps.

- ▶ Securely connect the wires of the connecting cable in accordance with the terminal assignments.
- ▶ After you close the housing again, use a pressure gauge to check the integrity of the IP69K protection. For details, contact the Sartorius Service Center.

Connecting Cables

- ▶ Insert all cable wires through the ferrite case, wind them around the ferrite case and then reinsert back through the ferrite case.
- ▶ Screw the wires tightly into the clamps.

See the following pages for terminal pin allocation

- ▶ Refer to the data sheet or operating instructions of the weighing platform for details on the assignment of wire colors/signals. Ensure any lines that are not assigned are insulated correctly.
- ▶ When connecting a load receptor that uses 4-conductor technology (the cable of the weighing platform to be connected only has 4 lines), connect clamp pairs 1 and 2 (EXC+ und SENSE+), and 5 and 6 (SENSE- und EXC-) with a wire jumper.

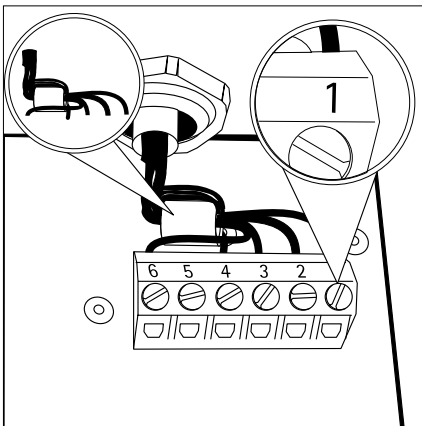

Connecting Weighing Platforms: Combics 1

Interface PCB for ADC 2*3000e (option A8)

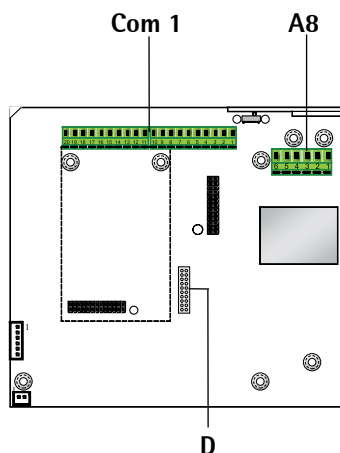

COM1 terminal assignments

1	LOAD_PRINTER	11	Clear to Send (CTS)
2	RESET_OUT	12	Data Terminal Ready (DTR)
6	3:GND	13	Data Input (RXD)
4	GND	14	Data Output (TXD)
5	5V_OUT	15	GND
6	5V switched	16	Universal In
7	GND	17	Control Output: "lighter"
8	GND	18	Control Output: "equal"
9	n.c.	19	Control Output: "heavier"
10	LINE_OUT	20	Control Output: "set"

A8

1	EXC+	Bridge supply voltage (+)
2	SENSE+	Sense (+) for bridge supply voltage
3	OUT+	Measuring voltage positive
4	OUT-	Measuring voltage negative
5	SENSE-	Sense (-) for bridge supply voltage
6	EXC-	Bridge supply voltage (-)

D connection of display and control unit

Interface PCB for ADC 10.000e (option A10)

COM1 terminal assignments, see above

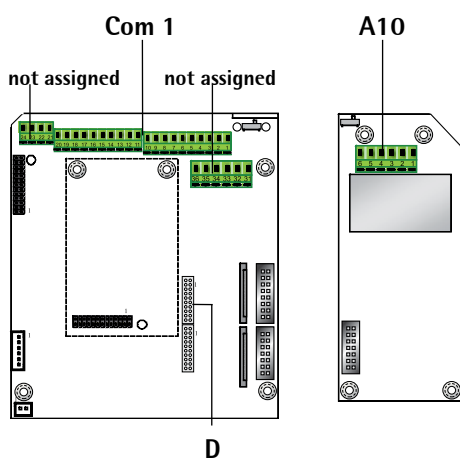

A10

1	EXC+	Bridge supply voltage (+)
2	SENSE+	Sense (+) for bridge supply voltage
3	OUT+	Measuring voltage positive
4	OUT-	Measuring voltage negative
5	SENSE-	Sense (-) for bridge supply voltage
6	EXC-	Bridge supply voltage (-)

D Display and control unit connection

Interface PCB for RS-232/485 (option A6/A7)

COM1 terminal assignments, see above

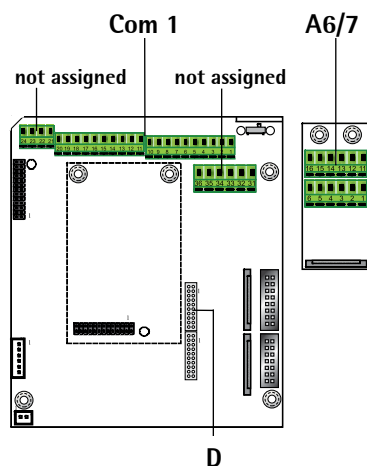

A6/7

1	CTS	11	TxD/RxD+
2	DTR	12	TxD/RxD-
3	RxD	13	LINE_OUT
4	TxD	14	LINE_OUT
5	GND	15	GND
6	Calibration Lock	16	GND

D connection of display and control unit

Connecting Weighing Platforms: Combics 2

Interface PCB for ADC 2*3000e (option A8)

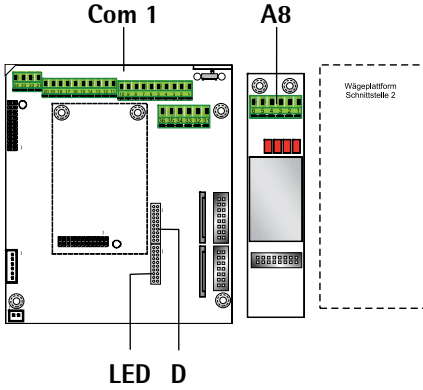

COM1 terminal assignments (applies to all PCBs)

1	LOAD_PRINTER	11	Clear to Send (CTS)	21	5 V switched
2	RESET_OUT	12	Data Terminal Ready (DTR)	22	PS2_Data
3:	GND	13	Data Input (RXD)	23	PS2_Timer
4	GND	14	Data Output (TXD)	24	GND
5	5V_OUT	15	GND	31	Not assigned
6	5V switched	16	Universal In	32	Not assigned
7	GND	17	Control Output: "lighter"	33	Not assigned
8	GND	18	Control Output: "equal"	34	Not assigned
9	n.c.	19	Control Output: "heavier"	35	Not assigned
10	LINE_OUT	20	Control Output: "set"	36	Not assigned

A8 terminal assignments see Combics 1

D Display and control unit connection

LED (LED connection)

Interface PCB for RS-232/485 for IS weighing platform (option A6/A7)

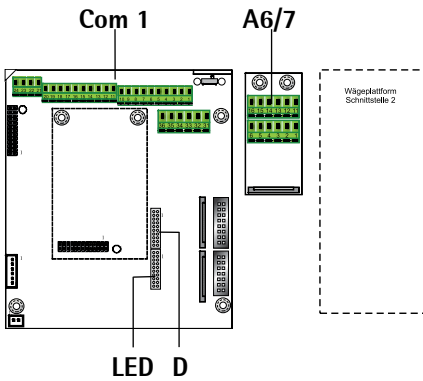

A6/7

1	CTS	11	TxD/RxD+
2	DTR	12	TxD/RxD-
3	RxD	13	LINE_OUT
4	TxD	14	LINE_OUT
5	GND	15	GND
6	Calibration Lock	16	GND

D Display and control unit connection

LED (LED connection)

Interface PCB for ADC 10.000e (option A20)

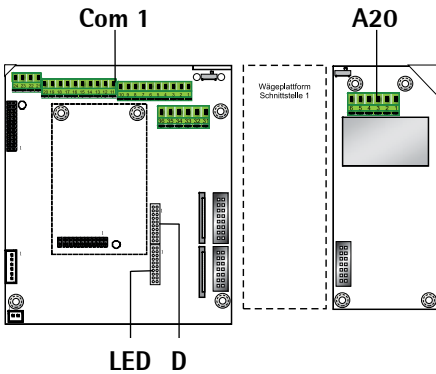

A20

1	EXC+
2	SENSE+
3	OUT+
4	OUT-
5	SENSE-
6	EXC-

D Display and control unit connection

LED (LED connection)

Interface PCB for RS-232/485 for IS weighing platform (option A62/A72)

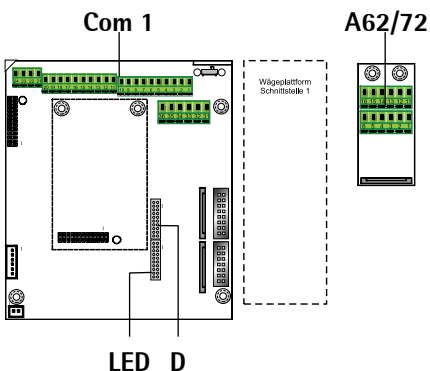

Interface PCB A6/7 and A62/72

1	CTS	11	TxD/RxD+
2	DTR	12	TxD/RxD-
3	RxD	13	LINE_OUT
4	TxD	14	LINE_OUT
5	GND	15	GND
6	Calibration Lock	16	GND

D Display and control unit connection

LED (LED connection)

Pin Assignment Chart

Models CAISL1 and CAISL2 (IP44 protection)

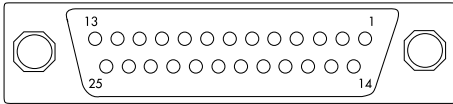

COM1 female connectors:

25-pin D-Submini female connector (DB25S) with screw lock hardware for cable gland

Recommended interface connector:

25-pin D-Submini (DB25) with shielded cable clamp assembly and shield plate (Amp type 826 985-1C) and fastening screws (Amp type 164868-1)

COM1 pin assignments

Pin 1:	Shield
Pin 2:	Data output (TxD)
Pin 3:	Data input (RxD)
Pin 4:	GND
Pin 5:	Clear to send (CTS)
Pin 6:	Not assigned
Pin 7:	Internal ground (GND)
Pin 8:	Internal ground (GND)
Pin 9:	Not assigned
Pin 10:	Not assigned
Pin 11:	+12V for printer
Pin 12:	RES_OUT\
Pin 13:	+5V Switch
Pin 14:	Internal ground (GND)
Pin 15:	Universal switch
Pin 16:	Control output: "lighter"
Pin 17:	Control output: "equal"
Pin 18:	Control output: "heavier"
Pin 19:	Control output: "set"
Pin 20:	Data terminal ready (DTR)
Pin 21:	Ground power supply (GND)
Pin 22:	Not assigned
Pin 23:	Not assigned
Pin 24:	Power supply +15 to 25V (peripherals)
Pin 25:	+5V

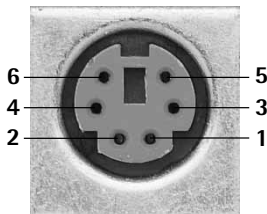

PS/2 socket pin assignment on Combics 2

Pin 1: Keyboard data (data interface cable)

Pin 2: Not assigned

Pin 3: GND (ground)

Pin 4: 5V switched

Pin 5: Keyboard clock

Pin 6: Not assigned

Connecting an IS Weighing Platform to a Combics 2

You can connect an IS weighing platform to WP2.

Features

- IS weighing platforms process weighing data independently of the indicator.
- Internal calibration/adjustment option
- IS...-OCE models: have a separate approval number, printed on a tag that is affixed to the cable.
- Please observe the conditions described in the manual for the weighing platform you connect.

Cabling Diagram - Connection to a PC

Use the following cables to connect a PC to the indicator in accordance with the RS-232C/V24 standard (max. cable length 15 m):

Models CAISL1, CAISL2: connecting cable 7357312

Models CAIS1, CAIS2: connecting cable YCC02-D9F6

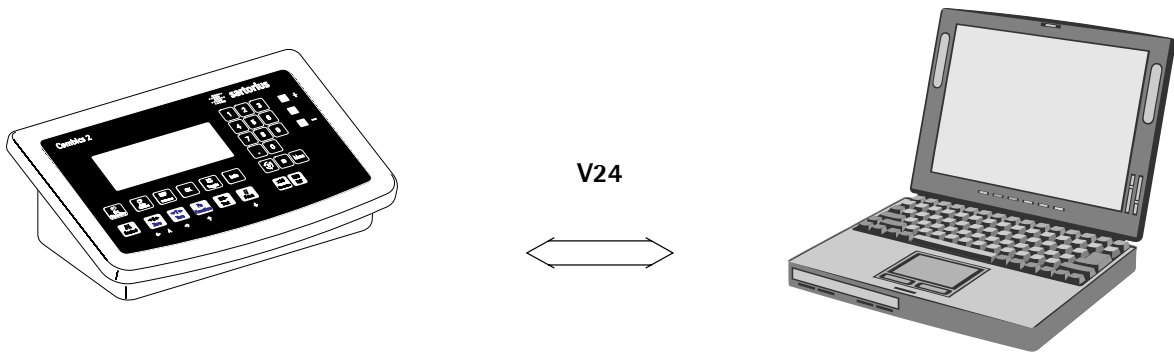

Cable Diagrams

Connection assignments for the cable from the indicator to an RS-232 PC interface (COM1).

Indicator side

Models **CAISL1, CAISL2**
25-pin D-Sub male connector

Sgn GND 1
TxD 7
RxD 2
DTR 3
CTS 20
5

PC side

DSUB connector
9-pin or 25 pin

5 GND 7 GND
2 RxD 3 RxD
3 TxD 2 TxD
8 CTS 5 CTS
4 DTR 20 DTR

Models **CAIS1, CAIS2**

Open cable end

Sgn GND 15
TxD 14
RxD 13
DTR 12
CTS 11

DSUB connector
9-pin or 25 pin

5 GND 7 GND
2 RxD 3 RxD
3 TxD 2 TxD
8 CTS 5 CTS
4 DTR 20 DTR

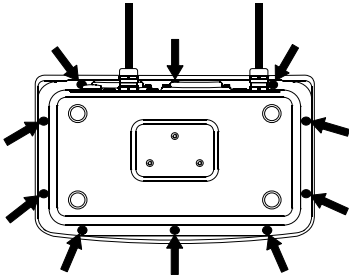

Closing the CombiCS indicator:

- ▶ Re-attach the front panel and secure it with 1 Nm the ten cap nuts.

Connecting the Device to AC Power

The device is powered through the installed power cord. The power supply is integrated into the indicator. The device can be operated with a voltage of 100 V to 240 V.



The power connection must be made in accordance with the regulations applicable in your country.

The printed voltage rating (see type label) must match the voltage in the place of installation. If the voltage specified on the label or the plug design of the AC adapter do not match the rating or standard you use, please contact your Sartorius office or dealer.

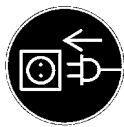

- ▶ Check the voltage rating and plug design.
- ▶ The device must be plugged into a properly installed wall outlet.

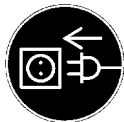

Protection Class 1 Device

- ▶ The device must be plugged into a properly installed wall outlet which has a protective grounding conductor (PE).

Safety Precautions



If you use an electrical outlet that does not have a protective grounding conductor, ensure that an equivalent protective conductor is installed by a certified electrician (as specified in the applicable regulations for installation in your country).

The protective effect must not be negated by using an extension cord without a protective grounding conductor.

Before using for the first time, any superstructure parts must be completely installed. Avoid connecting the equipment to lines that have a heavy electrical load, e. g. compressors, large machinery, etc.

Warm-up Time

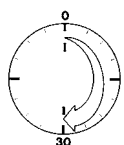

To deliver exact results, the device must warm up for at least 30 minutes after connection to AC power. Only after this time will the device have reached the required operating temperature.

Using a Verified Device in Legal Metrology:



Ensure that there is a warm-up time of at least 24 hours after connection to the power supply.

Connecting a Barcode Scanner (Accessory, Order No. YBR02CISL)

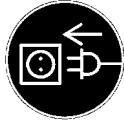

- ▶ Disconnect the indicator from AC power (unplug the AC adapter)

For CAISL2 models:

- ▶ Connect the barcode scanner via PS/2.

For CAIS2 models:

- ▶ Please see “Pin Assignment Charts,” page 13 (implemented via the YCC02-BR02 connecting cable or as option M8)



NOTE: This equipment has been tested and found to comply with the limits pursuant to part 15 of FCC Rules. These limits are designed to provide reasonable protection against harmful interference. This equipment generates, uses and can radiate radio frequency energy and, if not installed and used in accordance with these instructions, may cause harmful interference to radio communications. For information on the specific limits and class of this equipment, please refer to the Declaration of Conformity. Depending on the particular class, you are either required or requested to correct the interference. If you have a Class A digital device, you need to comply with the FCC statement as follows: “Operation of this equipment in a residential area is likely to cause harmful interference in which case the user will be required to correct the interference at his own expense.”

Configuring Weighing Platforms

Service Mode

Purpose The Service mode enables access to additional menu items in the Setup menu (*SETUP*) which are not displayed when the Service mode is not active. The most important calibration and adjustment work for the indicator and for the connected weighing platform can be carried out in the Service menu, e.g. ADC configuration.

When the Service mode is active, an “S” is shown in the top right-hand corner of the display. To deactivate the Service mode, restart the indicator (turn the indicator off and back on again).



In Service mode, the *SETUP* menu is expanded with the following parameters after entering the user password:

- *S-DATE* for entering the next service date
- *SER.NO* for entering the device serial number
- *MODEL* with the model description
- *S-SADMIN*
- *ALIBI.MEM* for deleting the Alibi memory

The Setup menu for *WP 1* and *WP 2* can be extended to include the following setting options:

param 1		
<i>CAL./ADJ.</i> Calibration, adjustment	1.9.	
Internal linearization (for WP-2 only)		1.9.5
<i>CAL.EXT</i> External linearization with default weights		1.9.6
<i>CAL.USR.</i> External linearization with user-defined weights (entered under 1.18)		1.9.7
<i>SET.PREL.</i> Setting the preload		1.9.8
<i>DEL.PREL.</i> Clearing the preload		1.9.9
<i>HNEXT / CAL./ADJ.</i> Entering the adjustment and linearization weights	1.18.	
<i>LIN.WT.1</i> Entering the lin. weight 1		1.18.2
<i>LIN.WT.2</i> Entering the lin. weight 2		1.18.3
<i>LIN.WT.3</i> Entering the lin. weight 3		1.18.4
<i>LIN.WT.4</i> Entering the lin. weight 4		1.18.5
<i>ADJ.W/O.W</i> Adjustment without weights (entering the characteristic data of the load cell(s))	1.19.	
<i>NOM.LOAD</i> Nominal load		1.19.1
<i>RESOLUT</i> Resolution		1.19.2
<i>SENSIT.1</i> Sensitivity in mV/V for cell 1 (or average value for all load cells)	1.19.3	
<i>SENSIT.2</i> Sensitivity in mV/V for cell 2		1.19.4
<i>SENSIT.3</i> Sensitivity in mV/V for cell 3		1.19.5
<i>SENSIT.4</i> Sensitivity in mV/V for cell 4		1.19.6
<i>SAVE</i> Save values for 1. 19		1.19.7
<i>GEOG.DAT</i> Adjustment location (geographical data; or alternatively the gravitational acceleration at the place of installation)	1.20.	
<i>LATITUDE</i> Latitude in degrees		1 20.1
<i>ALTITUDE</i> Elevation in meters above sea level		1 20.2
<i>GRAVITY.</i> Gravitational acceleration		1 20.3
<i>SAVE.</i> Save values for 1. 20		1 20.4
ADC settings (menu see page 19)	11	
Applying the serial number of the IS weighing platform (verified weighing platform at WP2)	12.1	
Apply the serial number		12.1.1
Inactive (standard WP)		12.1.2

Activating the Service Mode



 ...  ► Switch to the Menu mode (see page 35).

  ... ► Access the *SETUP* menu.

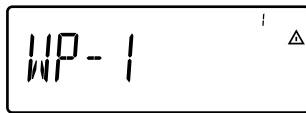

 ► Select *SETUP*
 If a password is requested at this point, enter the service password (see Appendix) and continue with “Saving the service password.”



  ... ► Access the *U-CODE* menu item





 ► Select *U-CODE*

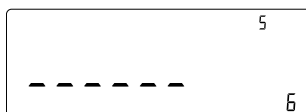

► Enter the service password (see Appendix).

 ► Apply the service password
 ► The Service mode is active: an “5” appears in the top right-hand corner of the display.



  ► Return to *SETUP* in the Service mode.

Analog/Digital Converter (ADC)

Purpose Adjust the parameters of the analog/digital converter to the connected load cell or weighing platform. After ADC configuration, the ADC in connection with the load sensor is defined as a scale.



Once the ADC configuration has been locked, the indicator can no longer be used to influence weighing results. The scope of functions available in the weighing instrument is defined by the A/D converter. Weighing functions that can be activated include reading weight values, taring, adjustment, reading the tare value, saving/deleting the tare entry

- Setup information**
- ADC configuration is only possible when the menu access switch is open. Close the menu access switch after ADC configuration, as otherwise there will not be any display of the conditions “overload” (“H”) and “underload” (“L”).
 - Before ADC configuration, you must first set whether or not the weighing platform will be used as a standard or verifiable weighing platform under menu item 9.1.
 - When the Service mode is activated, ADC configuration can be carried out in the *SETUP* menu under “*WP-1*” for the first weighing platform and *COM1 / WP-2*, *UNICOM / WP-2* or *COM-WP* for the second weighing platform.



If you return to the highest level of the Setup menu without saving the configuration parameters beforehand (menu item 11.10) any settings that have been made will be deleted.

- The settings are made in the corresponding Setup menu under menu item 11.
- Enter the maximum capacities in a suitable weight unit, without any decimal places (decimal places will be truncated by the rounding function).
- Entries made in the ADC configuration will not be affected by a menu reset (returning the setup parameters to their factory settings).

Factory settings/Reset menu	9.1
<i>WT.PARA</i>	
<i>STANDARD</i> Standard configuration	9.1.3
<i>RANGES</i> Ranges	11.3
<i>SINGLE</i> Single-range scale	11.3.1
<i>MULT.INT</i> Multi-interval scale	11.3.2
<i>MULT.RNG</i> Multiple-range scale	11.3.3
<i>SINGLE</i> Single-range scale	11.4
<i>d</i> Scale interval d	11.4.1
<i>MAX.</i> Max. load	11.4.4
<i>MULT.INT</i> Multi-interval scale	11.5
<i>d</i> Scale interval d	11.5.1
<i>RANGE 1</i> Range 1	11.5.4
<i>RANGE 2</i> Range 2	11.5.5
<i>RANGE 3</i> Range 3	11.5.6
<i>MAX</i> Max. load	11.5.7
<i>MULT.RNG</i> Multiple-range scale	11.6
<i>d</i> Scale interval d	11.6.1
<i>RANGE 1</i> Range 1	11.6.4
<i>RANGE 2</i> Range 2	11.6.5
<i>RANGE 3</i> Range 3	11.6.6
<i>MAX</i> Max. load	11.6.7
<i>WT.UNIT</i> Available weight units	11.7
<i>FREE</i> User-defined / o	11.7.1
<i>G</i> Grams /g	11.7.2
<i>KG</i> Kilograms /kg	11.7.4
...	
<i>T</i> Tons /t	11.7.21
<i>LB</i> Pound:ounces/ lb oz	11.7.22
<i>CAL.UNIT</i> Calibration / Adjustment unit	11.8

	<i>FREE</i>	User-defined / o	11.8.1
	<i>G</i>	Grams /g	11.8.2
	<i>KG</i>	Kilograms /kg	11.8.3
		...	
	<i>T</i>	Tons /t	11.8.21
<i>SAVE</i>	Save configuration parameters		11.10
	<i>YES</i>	Yes	11.10.1
	<i>NO</i>	No	11.10.2
Factory settings/Reset menu			9.1
<i>WT.PARA</i>			
<i>VERIF.</i>	Verifiable configuration		9.1.4
<i>CLASS</i>	Accuracy class		11.1
		Class III / III	11.1.4
<i>RANGES</i>	Ranges		11.3
	<i>SINGLE</i>	Single-range scale	11.3.1
	<i>MULT.INT</i>	Multi-interval scale	11.3.2
	<i>MULT.RNG</i>	Multiple-range scale	11.3.3
<i>SINGLE</i>	Single-range scale		11.4
	<i>E</i>	Verification scale interval e	11.4.2
	<i>MIN.</i>	Min. load	11.4.3
	<i>MAX.</i>	Max. load	11.4.4
<i>MULT.INT</i>	Multi-interval scale		11.5
	<i>E</i>	Verification scale interval e	11.5.2
	<i>MIN.</i>	Min. load	11.5.3
	<i>RANGE 1</i>	Range 1	11.5.4
	<i>RANGE 2</i>	Range 2	11.5.5
	<i>RANGE 3</i>	Range 3	11.5.6
	<i>MAX.</i>	Max. load	11.5.7
<i>MULT.RNG</i>	Multiple-range scale		11.6
	<i>E</i>	Verification scale interval e	11.6.2
	<i>MIN.</i>	Min. load	11.6.3
	<i>RANGE 1</i>	Range 1	11.6.4
	<i>RANGE 2</i>	Range 2	11.6.5
	<i>RANGE 3</i>	Range 3	11.6.6
	<i>MAX.</i>	Max. load	11.6.7
<i>WT.UNIT</i>	Available weight units		11.7
	<i>FREE</i>	User-defined / o	11.7.1
	<i>G</i>	Grams /g	11.7.2
	<i>KG</i>	Kilograms /kg	11.7.4
		...	
	<i>T</i>	Tons /t	11.7.21
	<i>LB</i>	Pound:ounces/ lb oz	11.7.22
<i>CAL.UNIT</i>	Calibration / Adjustment unit		11.8
	<i>FREE</i>	User-defined / o	11.8.1
	<i>G</i>	Grams /g	11.8.2
	<i>KG</i>	Kilograms /kg	11.8.3
		...	
	<i>T</i>	Tons /t	11.8.21
<i>SAVE</i>	Save configuration parameters		11.10
	<i>YES</i>	Yes	11.10.1
	<i>NO</i>	No	11.10.2

Setting parameters for ADC configuration

Standard or verifiable configuration	In ADC configuration, you must first select whether the weighing platform should be configured as a standard or verifiable (for use in legal metrology) weighing platform. <ul style="list-style-type: none"> – Standard configuration <i>STANDARD</i> (9.1.3) – Verifiable configuration <i>VERIF.</i> (9.1.4).
Accuracy class	<i>CLASS</i> Menu item 11.1 (only displayed in verifiable configuration) Only menu item 11.1.4 (accuracy class III/III) can be selected here. If the menu item is not already marked as being active with a circle (o), the ↔T↔ key must be pressed once to activate it.
Configuration unit	<i>WT.UNIT</i> Menu item 1.7 The weight unit used in the ADC configuration must have previously been selected here.
Range selection	<i>RANGE</i> Menu item 11.3 Depending on the setting under this menu item, the Menu items 11.5, 11.6 and 11.7 will either be displayed or will not be displayed for further configurations. <ul style="list-style-type: none"> – Single range mode (11.3.1) The entire weighing capacity is divided into decimal numbers dependent on the smallest scale interval d and the maximum weight. The readability corresponds to the scale interval d. – Multiple-range scale (11.3.2) A multiple-range scale has two or three weighing ranges. When the range limit for the lower weighing range is exceeded, the scale switches into the next highest weighing range (lower resolution). The scale only switches back to the lower weighing range (higher resolution) when the weighing platform has been completely unloaded after pressing the ↔T↔ key. – Multi-interval scale (11.3.3) – The function “Multi-interval scale” divides the weighing capacity into a maximum of three ranges with differing readability. The corresponding change takes place automatically at the defined range limits. Once the scale has been tared, the highest possible resolution is available even if the weighing platform is loaded.
Scale interval d	The scale interval d indicates the resolution of the weighing instrument. The scale interval can only be entered in increments of 1, 2, 5, 10, 20, etc. When “Verifiable configuration” is used, this menu item is not displayed. When using verifiable or verified weighing platforms (classes l and m), the scale interval d is the same as the verification scale interval e.
Verification scale interval e	The verification scale interval e indicates the resolution of the weighing instrument in legal metrology. The scale interval can only be entered in increments of 1, 2, 5, 10, 20, etc. When “Standard configuration” is used, this menu item is not displayed.
Maximum load (max. load)	The maximum load is the maximum amount of weight that may be placed on the weighing platform. When heavier weights are used the weighing instrument displays overload “H”. The scale intervals of the weighing instrument are calculated using the maximum load and the scale interval d (e.g. max. capacity = 15.000 kg, smallest scale interval d = 0.005 kg yields 3000 scale intervals). In legal metrology the total number of intervals must be no more than 3000 e, and when using multi-interval scales there must not be more than 3000 e intervals per range. In standard operation, as opposed to legal metrology, you can define a “Super Range” weighing instrument of over 3000 intervals. These parameters, however, may be influenced by physical restrictions.

Minimum load (min. load) When “Standard configuration” is used, this menu item is not displayed. The minimum load of the connected weighing platform is entered under this menu item. The minimum load for scales of class III is 20 e and 10 e for class III .

Attention: The function of the minimum load setting is to warn operators that below this limit, the summation of tolerances might lead to significant measurement errors. In Germany, for example, initial weights below the minimum load are not allowed.

Range 1, Range 2, Range 3 The range limits are entered for the individual ranges. The accuracy changes when these limits are exceeded.

The following applies when entering limits:

Range 1 < Range 2 < Range 3 < max. load

This means that the weighing range can be divided into a maximum of 4 ranges.

The resolution changes at intervals of 1, 2, 5, 10, 20 etc., where the lowest resolution is the smallest scale interval entered. Set ranges that are not required for use to zero.

Available weight units *WT.UNIT* Menu item 11.7

This menu item is used to select the weighing units that have been cleared for use in weighing. All units marked with a circle (o) have been cleared for use, multiple selection is possible.

Calibration / Adjustment unit *CAL.UNIT* Menu item 11.8

This menu item is used to select the weighing unit that must be used for a calibration/adjustment. The selected unit is then valid as a calibration/adjustment unit even when a different unit is used during normal weighing operation.

Save parameters *SAVE* Menu item 11.10

The ADC configuration data are saved by selecting Menu item 11.10.1.

Testing and configuration for operation in legal metrology

A metrology plate is included in the scope of supply of the indicator.

Once ADC configuration is complete, record the metrological data for all ranges on the metrology plate. Attach the plate underneath the display and cover with the supplied waterproof acetate foil.

- Under the menu item 1.7, check that only authorized weight units can be selected.

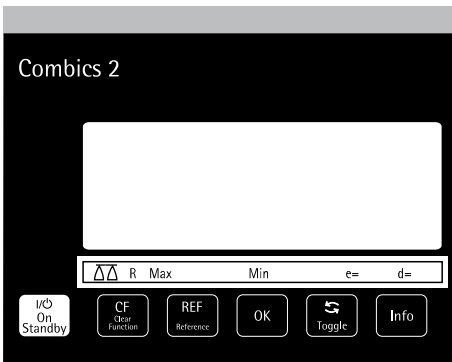

Configuring the A/D converter (ADC)

The weighing platform must already be connected.

Open the menu access switch

The menu access switch is located on the back of the indicator right next to the weighing platform connection.

- ▶ Remove the cap.
- ▶ Slide the switch to the left (= "open" position).

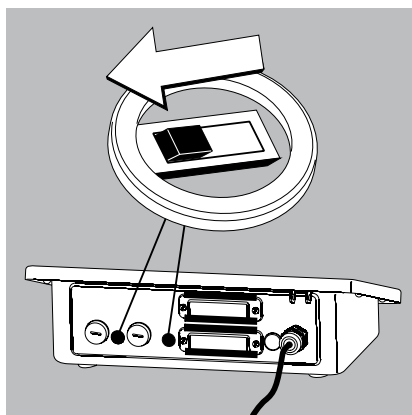

- ▶ Switch off and restart the device.

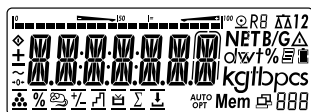

- ▶ While all segments are lit, briefly press the $\rightarrow 0 \leftarrow$ key.



- ▶ *ADC-CON* appears briefly on the display and the $\bar{5}$ -CODE

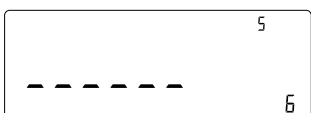

- ▶ The cursor flashes on the display.
- ▶ Enter the service password (see Appendix).



- ▶ Confirm your entry using the $\rightarrow T \leftarrow$ key.

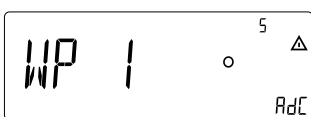

- ▶ The device is in Service mode. This can be recognized by the small $\bar{5}$ in the top right of the display.
- ▶ Select the weighing platform to be configured, using the Fn key to switch to WP-2 if required.



- ▶ Confirm your selection using the $\rightarrow T \leftarrow$ key.

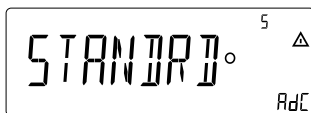

- ▶ Select the Configuration mode using the Fn key: *STANDARD* or *VERIF..*

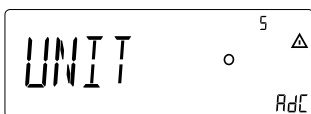

- ▶ Carry out ADC configuration (see menu tree starting on p. 19).



- ▶ Once you have completed the configuration, save the data using the *SAVE* menu item.
- ▶ The indicator will restart automatically.

The A/D converter can now be treated like a standard weighing platform in connection with the load sensor.



- ▶ Close the menu access switch (right position) and reattach the cap. Once ADC configuration has been completed, an adjustment of the weighing platform (calibration/adjustment and linearization) must be carried out (see page 47 and “Calibration/Adjustment without Weights”, page 30).

Entering Geographical Data for Use in Legal Metrology

Purpose Entering geographical data allows the external adjustment of weighing equipment at a place (e.g. at the manufacturer or vendor’s place of business) that is not the same as the place of installation. If the weighing equipment is adjusted at the place of installation, it is not necessary to enter geographical data.

The sensitivity of weighing equipment changes depending on the place of installation as it is dependent on the on-site gravitational force – or, more precisely, on gravitational acceleration. Saving geographical data makes it possible to change the place of installation of the weighing equipment after external adjustment has been carried out.

The adjustment of weighing equipment is valid at the place of installation and within a specific tolerance zone. At 3000 e this zone extends ± 100 km from the set geographical latitude and ± 200 m from the set elevation above sea level.

Installation Location in Germany

An exception to this is the setting for “Germany (Zone D):” If during external adjustment of weighing equipment within Germany the geographical data

- Geographical latitude: 51.00 degrees N
- 513 m elevation above sea level

are entered, the weighing equipment can be used throughout Germany.

Gravitational acceleration for “Germany (Zone D)” is 9.810 m/s^2 . On delivery the geographical data for “Germany (Zone D)” are entered in the output device.

It is recommended to use the geographical data settings for “Germany (Zone D)” when adjusting and delivering the weighing equipment within Germany. Entering exact geographical data will lead to a higher level of accuracy but will also restrict the tolerance zone.

Setup information

- It is only possible to enter geographical data when the menu access switch is open.
- When the Service mode is activated, you can enter geographical data in the *SETUP* menu under “WP- 1” for the first weighing platform and *COM 1 / WP-2*, *UNICOM / WP-2* or *COM-WP* for the second weighing platform. The settings are made in the corresponding Setup menu under menu item 1.20.
- You can enter either the “geographical latitude in degrees” (*LATITUDE* menu item 1.20.1) and “elevation in m above sea level” (*ALTITUDE* menu item 1.20.2), or the value for gravitational acceleration (*GRAVITY* menu item 1.20.3). Gravitational acceleration takes precedence over the geographical latitude and elevation of the location: If it has been entered, input fields for latitude and elevation show the values 99999.99 and 9999999 respectively. If only elevation and latitude have been entered, 0000000 is displayed for gravitational acceleration.



If you return to the highest level of the Setup menu without saving the configuration parameter beforehand (save menu item 1.20.4) any settings that have been made will be deleted.

- Procedure**
- ▶ Open the menu access switch.
If the device is part of a verified weighing facility, this will only be possible if the verification seal is broken. The weighing equipment must then be verified again.
 - ▶ Activate the Service mode.
 - ▶ Select the weighing platform.
 - ▶ Enter the geographical data for the place of adjustment under menu items 1.20.1 to 1.20.3 and save them under menu item 1.20.4. The data can be obtained from the relevant land registry or Ordnance Survey.
 - ▶ Carry out external calibration.
 - ▶ After the calibration, enter the geographical data for the place of installation under menu items 1.20.1 to 1.20.3 and save them under menu item 1.20.4.
 - ▶ Close the menu access switch.
 - ▷ The weighing equipment can now be operated at the place of installation, and within the abovementioned tolerance zone.

Note: The set geographical values are displayed during the adjustment procedure if the display of the data has been activated in the Setup menu under *UTILIT.* menu item 8.12.2 (factory setting: 8.12.1, display deactivated).

When the display is activated the adjustment procedure is as follows:

- ▷ If the elevation and geographical latitude are used, the word "*ALITUD*" will appear briefly followed by the set elevation (in meters above sea level) after the start of the *CAL* adjustment procedure.
- ▶ Confirm the display using the $\rightarrow T \leftarrow$ key (cancel using the $\rightarrow 0 \leftarrow$ key).
- ▷ Then the word "*LATITUD*" will be displayed briefly followed by the set geographical latitude in degrees.
- ▶ Confirm the display using the $\rightarrow T \leftarrow$ key (cancel using the $\rightarrow 0 \leftarrow$ key).
- ▷ You are then asked to place the calibration weight on the weighing platform. If gravitational acceleration has been entered instead of elevation and geographical latitude, the word "*GRAVITY*" will appear briefly, followed by the set value for gravitational acceleration.
- ▶ Confirm the display using the $\rightarrow T \leftarrow$ key (cancel using the $\rightarrow 0 \leftarrow$ key).

Menu structure for entering the geographical data

<i>GEOG.DAT</i> Adjustment location (geographical data; or alternatively the gravitational acceleration at the place of installation)	1.20.	
<i>LATITUD</i> Latitude in degrees		1.20.1
<i>ALITUD</i> Elevation in meters above sea level		1.20.2
<i>GRAVITY</i> Gravitational acceleration		1.20.3
<i>SAVE</i> Save values for 1. 20		1.20.4

Entering Adjustment and Linearization Weights

Purpose Entering adjustment and linearization weights.

- Setup information**
- The Service mode must be activated in order for linearization weights to be entered under menu items 1.18.2 to 1.18.5 (see page 17).
 - Adjustment and linearization weights can be entered in the *SETUP* menu under “WP-1” for the first weighing platform and *COM1 / WP-2*, *UNICOM / WP-2* or *COM-WP* for the second weighing platform. The settings are made in the corresponding Setup menu under menu item 1.18.
 - The Service mode does not have to be activated in order for external user-defined adjustment weights to be entered under menu item 1.18.1.
 - The adjustment and linearization weights must be entered in the unit selected for the ADC configuration under menu item 11.8.

- Procedure**
- ▶ Activate the Service mode (only necessary if linearization weights are going to be entered)
 - ▶ Select the weighing platform.
 - ▶ Enter the external user-defined adjustment weight under menu item 1.18.1
 - ▶ Enter the external linearization weight under menu items 1.18.2 to 1.18.5.

Menu structure for entering the adjustment and linearization weights

<i>HN</i> <i>EXT</i> Entering the adjustment and linearization weights	1.18.	
Entering external user-defined adjustment weight (Service mode not required)		1.18.1
<i>LIN.WT.1</i> Entering the lin. weight 1		1.18.2
<i>LIN.WT.2</i> Entering the lin. weight 2		1.18.3
<i>LIN.WT.3</i> Entering the lin. weight 3		1.18.4
<i>LIN.WT.4</i> Entering the lin. weight 4		1.18.5

Function Allocation of the Key

Purpose The  key is usually used for the calibration/adjustment function. For detailed information about calibration and adjustment, see “Operation” starting on page 47. The following additional functions can be allocated to the key when the Service mode is activated:

- External linearization with default weights (menu item 1.9.6)
- External linearization with the linearization weights (menu item 1.9.7) entered under menu item 1.18
- Internal linearization (for WP-2 only) (menu item 1.9.5)
- Set preload function (menu item 1.9.8)
- Clear preload function (menu item 1.9.9)



Once linearization has been completed, or after a preload has been set or cleared the function of the  key must be reallocated back to its original function in the Setup menu, e.g. external calibration/adjustment with default weights (Setup menu item 1.9).

Menu structure for the function allocation of the key

<i>CAL./ADJ.</i> Calibration, adjustment	1.9.	
Ext. calibration/adjustment with default weights (Service mode not required)		1.9.1
Ext. calibration/adjustment with user-defined weights (Entry under 1.18, Service mode not required)		1.9.3
<i>CAL.INT</i> Internal linearization (for WP-2 only)		1.9.5
<i>CAL.EXT</i> External linearization with default weights		1.9.6
<i>CAL.USR.</i> External linearization with user-defined weights (entered under 1.18)		1.9.7
<i>SET.PREL.</i> Setting the preload		1.9.8
<i>DEL.PREL.</i> Clearing the preload		1.9.9
<i>LOCKE</i> Key blocked		1.9.10

External Linearization

Setup information

- External linearization when weighing in legal metrology is only possible when the menu access switch is open.
- The “external linearization” function must be allocated to the  key (menu item 1.9.6 or 1.9.7).



Once linearization has been completed, the  key must be reallocated back to its original function in the Setup menu, e.g. external calibration/adjustment with default weights (Setup menu item 1.9).

Procedure

- ▶ For scales used in legal metrology: open the menu access switch.
- ▶ Zero the weighing platform.
- ▶ Activate the Service mode (see Page 17).



- ▶ Start linearization.
- ▶ After approximately 2 seconds you will be prompted to place the first linearization weight on the platform.



- ▶ Place the required weight on the platform.
- ▷ After a short time the difference between the measured value and the true weight of the sample will be displayed.



- ▶ Save the linearization weight (cancel using the  key).
- ▷ You will then be prompted to place the second linearization weight on the platform.



- ▶ Repeat the procedure for all required linearization weights.
- ▷ After the last linearization weight has been saved you will be prompted to remove any load from the weighing pan.

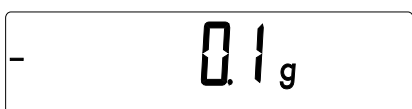

- ▶ Unload the weighing pan.
- ▶ After a short period of time the zero point will be applied automatically and the indicator will automatically switch back to weighing mode.
- ▶ Re-close the menu access switch.

Setup information

Setting the Preload

- Setting the preload when weighing in legal metrology is only possible when the menu access switch is open.
- The “Set Preload” function (menu item 1.9.8) must be allocated to the  key (see page 141).



Once the preload has been set, the  key must be reallocated back to its original function in the Setup menu, e.g. external calibration/adjustment with default weights (Setup menu item 1.9).

Procedure

- ▶ For scales used in legal metrology: Open the menu access switch.
- ▶ Zero the weighing platform.



- ▶ Place the preload weight on the weighing platform.

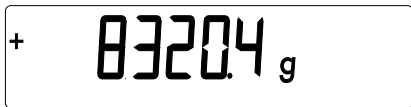

- ▶ Start the “Set Preload” function.

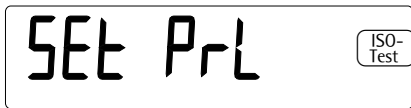

- ▶ After a short period of time the preload will be applied and the indicator will automatically switch back to weighing mode.



- ▶ Re-close the menu access switch.

Setup information**Deleting the Preload**

- Deleting the preload when weighing in legal metrology is only possible when the menu access switch is open.
- The “Set Preload” function (menu item 1.9.8) must be allocated to the  key (see page 141).



Once the preload has been deleted, the  key must be reallocated back to its original function in the Setup menu, e.g. external calibration/adjustment with default weights (Setup menu item 1.9).

Procedure

- ▶ For scales used in legal metrology: Open the menu access switch.
- ▶ Remove the preload weight from the weighing platform.

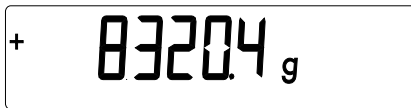

+ 8320.4 g

 hold

- ▶ Start the “Delete Preload” function.

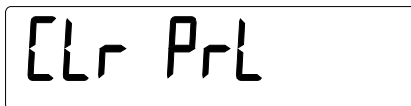

Clr PrL



0.0 g

- ▶ After a short period of time the preload will be deleted and the indicator will automatically switch back to weighing mode.
- ▶ Re-close the menu access switch.

Adjustment Without Weights

In the Service menu, adjustment without weights can be carried out by entering the characteristic data of the load cells.



Adjustment without weights may not be carried out on weighing equipment used in legal metrology.

Setup information

- Adjustment without weights is only possible when the menu access switch is open in the Service menu.
 - When the Service mode is activated, you can enter the necessary parameters for adjustment without weights in the *SETUP* menu under “*WP- 1*” for the first weighing platform and *COM 1 / WP-2*, *UNICOM / WP-2* or *COM-WP* for the second weighing platform. The settings are made in the corresponding Setup menu under menu item 1.19.
 - The “Nominal load” parameter must be entered in the kg unit.
 - The “Resolution” parameter must be entered in the kg unit and must correspond to the scale interval *d* entered for the ADC configuration.
 - The “Sensitivity” parameter is entered in mV/V (see the data sheet for the value).
- The data entered are saved by selecting menu item 1.19.7. After saving, the data will no longer be able to be read.



Procedure

- ▶ Open menu access switch.
- ▶ Activate the Service mode.
- ▶ Select the weighing platform.
- ▶ Enter the nominal load of the load cell(s) in kg under menu item 1.19.1. If the weighing platform has multiple load cells, the nominal load must be multiplied accordingly (e.g. 4 load cells, each of which has a capacity of 50 kg, will produce a nominal load of 200 kg)
- ▶ Enter the resolution in kg under menu item 1.19.2. The value must correspond to the scale interval *d* entered under menu item 11.4.1.
- ▶ Enter the sensitivity of the load cells in mV/V under menu item 1.19.3.
For weighing platforms with multiple load cells: Enter the individual values of the load cells in 1.19.3 to 1.19.6 or enter the average of all load cells in 1.19.3.
- ▶ Save the values for adjustment without weighing under menu item 1.19.7.
- ▶ Close the menu access switch.

Menu structure for adjustment without weights

<i>ADJ.W/O.W</i> Adjustment without weights (entering the characteristic data of the load cell(s))	1.19.
<i>NOM.LOAD</i> Nominal load	1.19.1
<i>RESOLUT</i> Resolution	1.19.2
<i>SENSIT.1</i> Sensitivity in mV/V for cell 1 (or average value for all load cells)	1.19.3
<i>SENSIT.2</i> Sensitivity in mV/V for cell 2	1.19.4
<i>SENSIT.3</i> Sensitivity in mV/V for cell 3	1.19.5
<i>SENSIT.4</i> Sensitivity in mV/V for cell 4	1.19.6
<i>SAVE</i> Save values for 1. 19	1.19.7

Operating Design

You can use the Combics 2 to record weight values from two weighing platforms, calculate and display weight values through application programs, and assign IDs to the samples weighed.

First, use the menu to configure the indicator for the desired application (printer settings, etc.). Then you can begin weighing.

The indicator keypad is used for operation. Each key can be assigned a weighing mode function and another function in the menu. Some of the keys also have an additional function when pressed and held for longer than 2 seconds.

When a key is pressed that does not have an active operating mode function, an acoustical signal (double beep) sounds and the message “----” is displayed for 2 seconds. The display then returns to the previous screen content.

Switching on the Device



- ▶ Briefly press the  key to turn on the indicator.

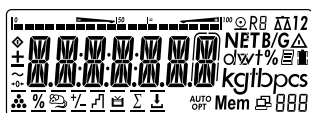

- ▷ The device carries out a self test every time it is turned on. During this time, all display segments light up for several seconds.

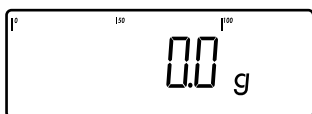

- ▷ Then the display for the weighing mode appears. The scale is started in the status it was in when it was turned off, e.g. with the last selected application.

The scale starts in the weighing mode. You must open the Menu mode (see page 35) to make settings or set up applications.

Weighing Operation

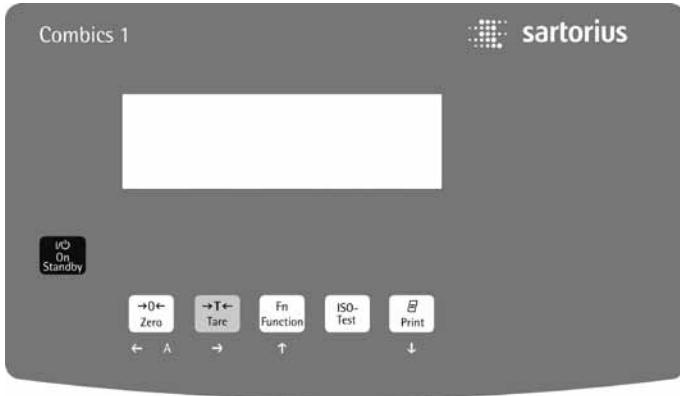

Combics 1

Combics 2

Keys for all models



On/Off key

When in Standby mode, *STANDBY* is displayed.



Zero key

- Press the key **less** than 2 seconds: Zero
- Press the key **longer** than 2 seconds: Displays the adjustment/configuration counter



Tare key

- Saves the numeric input as the tare weight
- Press the key longer than 2 seconds: Start calibration/adjustment



Function key: Depends on the configuration in the Setup menu, switches between the

- First and second weighing unit
- Gross and net values (Combics 1 only)
- Normal and 10-fold higher display resolution (Combics 1 only)
- Results display and SQmin display



ISO test: Start calibration or adjustment



Print key

- Press the key **less** than 2 seconds: Print
- Press the key **longer** than 2 seconds: Print GMP footer

Keys for Combics 2 only



Toggle key: When two platforms are connected, this key toggles the display between the two readouts.

The following four keys are used for operating the individual applications. Their exact function is described in the respective section for the application.



Delete key: Deletes initialization values or totalizing memory. During numeric entry the last character entered is deleted.







Reference value key: Changes the set reference value.



OK key: Applies values or starts an application program.



Toggle key: Toggles between display modes within an application program.

- Info** **Info key:** Used to display application parameters and manual tare values (Info after pressing a follow-up key, e. g. )
- 1**, **2**, **3** ... **.**, **0** **Number keys:** Used to enter numeric values
- ▶ To apply the value, press the corresponding function key (e.g. key  to save the entry as a manual tare value.
 - ▶ To delete the last character entered, press the  key.
-  **Application toggle key:** Toggles between available applications
- ID** **ID key:** Used to enter operator IDs
- Mem** **Save key:** Used to save values to the product data memory or load to the application
- x10** **Resolution toggle key:** Toggles to 10-fold increased resolution
- B/G** **Gross/Net value key:** Toggles between the gross or net value

Saving Settings in Weighing Mode

All application parameters saved (e.g., reference values) remain in memory and are available when













- the device has been switched off and then on again
- you return to the originally selected application from a second one (e.g., when you switch from Averaging back to Counting all parameters saved for Counting are available).

Applying the Tare Weight

- ▶ Place the tare object on the weighing platform.
- ▶ Press the  key.
- ▷ The value is applied as the tare value.

Input Through the Digital Control Port

You can connect an external hard drive or foot switch to the control port (universal interface). You can assign the following functions to the control port in the SETUP / CTRL IO / INPUT / PARAMET / EXT.KEYB menu:

-  key
-  key (hold)
-  key
-  key
-  key
-  key
-  key
-  key
-  key
-  key
- **Info** key
-  key
-  key
-  key

The Display

There are two display modes:

- Display for weighing (weighing values and calculated values)
- Display in "Menu mode" (device settings)

The figure shows the display of the Combics 2

Display in Weighing Mode

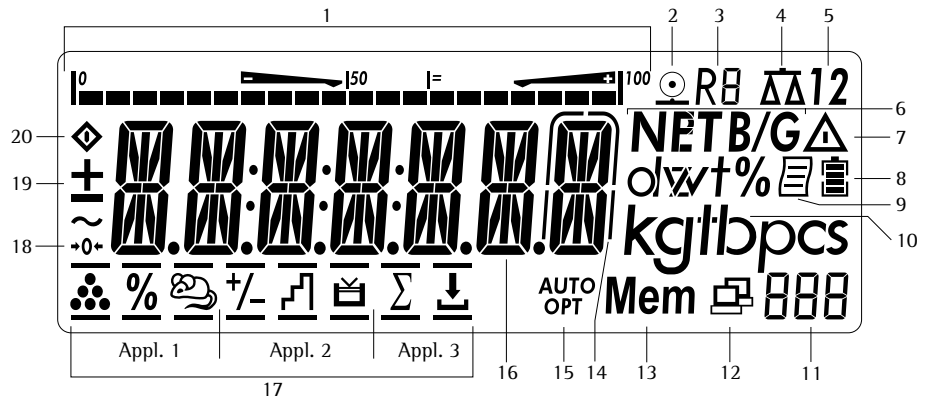

- 1* Bar graph showing 10% intervals
 - Shows the percentage of the weighing platform's capacity that is "used up" by the load on the scale (0% = lower limit, 100% = upper limit)
 - or
 - Shows the measured value in relation to a target value (with the "Checkweighing" or "Classification" applications)
- Minimum for checkweighing
 - Maximum for checkweighing
 - Target value for checkweighing
- 2 Symbol for active print job
- 3 Displays the active range on multiple-range scales
- 4 Indicates active weighing platform; flashes to prompt calibration/adjustment
- 5* 1 2 Selected weighing platform 1 or 2
- 6 **NET B/G** Net/Gross value on the main display (with tare in memory or preset tare)
- 7 Identifies the value on the main display as calculated (value not valid in legal metrology)
- 8 Battery charge status
- 9 GMP-compliant printing in progress
- 10 Weight unit of the value displayed
- 11* Numeric display; e.g., showing the reference value
- 12* Symbol indicating data transfer
 - Interface initialized (profibus/Ethernet)
 - Flashes during data transfer (RS-232/485)
- 13* **Mem** Symbol for product data memory
- 14 In legal metrology, on equipment with **e** not equal to **d**, the digit bordered for identification is not taken into account
- 15* **AUTO/OPT**
 - **AUTO**: Depending on the weight value, a reaction is triggered in the application
 - **OPT**: Automatic optimization takes place for the Counting application
- 16 Measured value line: Weight value or calculated value

* = for Combics 2 only

- 17* Symbols for applications: An active application is identified by a line above and below the symbol.
- Application 1*: "Counting"/ "Neutral Measurement"
- "Weighing in percent"
- "Averaging" (animal weighing)
- Application 2*: "Checkweighing"
- "Classification"
- "Checkweighing toward zero"
Manually batching to a target value
- Application 3*: "Totalizing"
- "Net total formulation"
- 18 The zero-setting symbol is displayed after the active scale or weighing platform has been zeroed (verified models only)
- 19 + - Plus or minus sign of the value displayed
- 20 Busy symbol indicates that an internal process is in progress

* = for Combics 2 only

Menu Operating Design

Switching to the Menu



- ▶ Turn on the device.
If it is already on: turn off and then on again.



- ▶ During the display test, briefly press the key.

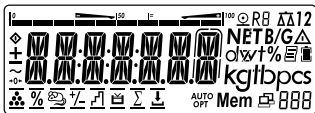

- ▶ The menu will open. The top most level is always displayed ("APPLIC."), menu structure see page 135.



Navigating the Menu

You can navigate the menu using the keys with the white arrows under them.

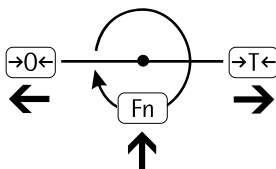

- Back to the superordinate menu level
- Access the next menu item on the same level.
This continues to page through on the same level.
- Press less than 2 seconds:** Select the menu item and save
Press longer than 2 seconds: Exit the menu and switch to weighing mode
- Print the menu settings starting from the current position, or print Info data

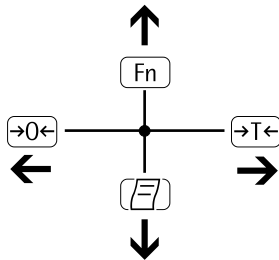

Entering Numbers and Letters (without a number block)

- 0←
 - Press the key **less** than 2 seconds: Activate character to the left of the currently active character (when first character is active: exit the input mode without saving changes)
 - Press the key **longer** than 2 seconds: Exit the input mode without saving changes
- T←
 - Press the key **less** than 2 seconds: Confirm currently active character and move 1 position to the right (after the last character: Save input)
 - Press the key **longer** than 2 seconds: Save current input and display the menu item
- Fn
 - Cursor in first position, no characters changed yet: Delete character(s) and enter 0
 - Change the displayed character; scroll forward (sequence: 0 through 9, decimal point, minus sign, Z through A, space)
- [←]
 - Cursor in first position, no characters changed yet: Delete entire string and enter a space
 - Change the displayed character; scroll backwards (sequence: Space, A through Z, minus sign, decimal point, 9 through 0)

Number entry for Combics 2:

Enter number values (date and time, etc.) using the 10-key numeric keypad

Menu Display

Both illustrations depict all of the main display elements and symbols that can be shown in Menu mode.

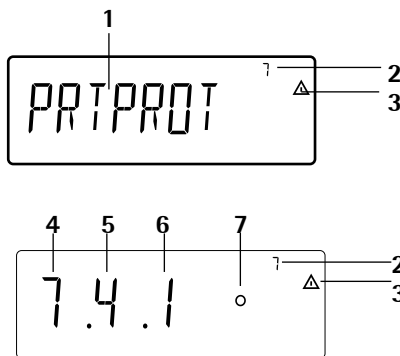

- 1 Selected menu item (e.g. printer for setting the connected printer)
- 2 Menu history (refers to the highest menu level in the Setup menu)
- 3 Note that other submenus are available

Display with the "COBES" language setting

- 4 First level in the Setup menu
- 5 Second level in the Setup menu
- 6 Third level in the Setup menu
- 7 Current active setting

Saving Menu Settings

The parameters selected in the menu remain saved when you switch to weighing mode or turn off the device. You can block access to the `SETUP` menu by requiring a password to prevent unauthorized or accidental setting changes (see page 38).

Configuration

Basic settings are made in the Menu mode by selecting the desired parameters. These are divided into the following groups (menu level 1), menu structure see page 135:

- Application parameters *APPLIC.*
- Function key *FN-KEY*
- Device parameters *SETUP*
- Device-specific information *INFO*
- User language *LANGUAG.*

When used in legal metrology, not all parameters can be accessed. Only those parameters that can be selected are displayed. Factory-set parameters are identified by an "*" in the list starting on page 136.

Printing Parameter Settings

- ▶ Access the Menu mode (see page 35)
- ▶ Press the  key

The scope of the printout depends on the position in the setup. It may take several seconds.

Language, setting

Example: Select the language "German." The factory setting for language is "English."
Menu: *APPLIC. / LANGUAG.*



- ▶ Turn on the device.

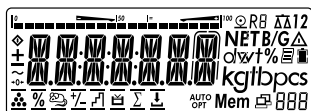

- ▶ While all segments are lit, briefly press the  key.



- ▷ The first item in the main menu is shown: *APPLIC.*



- ▶ Press the  key until the *LANGUAG* menu item appears for the language setting.



- ▶ Press the  key to access the language setting sub-menu.

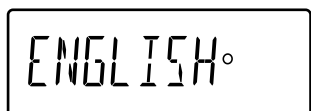

- ▷ The currently set language is displayed.



- ▶ Press the  key until *U.S. MODE* is displayed.



- ▶ Press the  key to save the selection.
- ▷ The small circle indicates that the setting has been saved.



- ▶ Use the **→0←** key to exit the menu level to make additional settings if required or
- ▶ Press the **→T←** key longer than 2 seconds to exit the menu.

Setting up Password Protection



- ▶ Turn on the device.

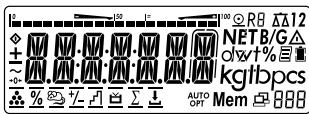

- ▶ While all segments are lit, briefly press the **→T←** key.



- ▶ The first item in the main menu is shown: *APPLIC..*



- ▶ Press the **Fn** key until the *SETUP* menu item is displayed.



- ▶ Press the **→T←** key to open the *SETUP* sub-menu.

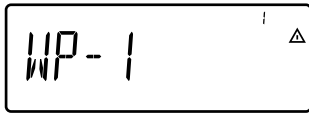

- ▶ The first parameter in the Setup sub-menu is displayed: *WP-1*.



- ▶ Press the **Fn** key until *U-CODE* is displayed.



- ▶ Press the **→T←** key to open the menu item.



- ▶ The position for the first character to be entered flashes.



- ▶ Use the **←** and **Fn** keys to select the desired character. The **←** starts the character selection with A alphabetical and the **Fn** key starts the character selection with 0 and counts upward.

- ▶ **→T←** To apply a character, press the **→T←** key.
 - ▶ Enter all additional characters of the password as described above.
 - ▶ Press and hold the **→T←** key to save the password.
- O←** Use the **→O←** key to exit the menu level to make additional settings if required
or
- T←** Press the **→T←** key longer than 2 seconds to exit the menu.

Changing or Deleting Passwords

- ▶ Open the *U-CODE* menu item in the *SETUP* menu as described above.
- ▶ The old password must be entered to change or delete a password.
- ▶ To change a password, overwrite the old password.
- ▶ To delete a password, enter spaces and press the **→T←** key.

Operation

Weighing

This application is always available during operation.

- Features:
- Zeroing by pressing $\rightarrow 0 \leftarrow$
 - Storing the weight on the platform as a tare by pressing $\rightarrow T \leftarrow$
 - Tare container weight automatically
 - Use a barcode scanner to enter tare weight (Combics 2)
 - Use a 10-key keypad to enter tare weight (Combics 2)
 - Delete tare values using the numeric entry 0 and $\rightarrow T \leftarrow$ / CF and $\rightarrow T \leftarrow$ (Combics 2)
 - Toggle the display using Fn between:
 - Combics 1: Gross and net values
 - 1st and 2nd weight unit or
 - Combics 1: Normal and 10-fold higher resolution
 - Weighing with two weighing platforms (for Combics 2 only)
 - Individual numeric ID codes for weight values (Combics 2)
 - Print weight value:
 - GMP-compliant printout
 - Automatic printout
 - Automatic data output (see Data Interfaces chapter)

Automatic taring (*APPLIC.* menu item 3.7):

When the menu item is active (3.7.2), the first weight on the scale that exceeds the preset minimum load is stored in the tare memory at stability.

The scale returns to the initial state when the load on the scale is less than 50% of the minimum load.

Minimum load for automatic taring and automatic printing

(menu item 3.5):

You can set the following for the minimum load:

- 1 digit (no minimum load)
- 2 digits
- 5 digits
- 10 digits
- 20 digits
- 50 digits
- 100 digits
- 200 digits
- 500 digits
- 1000 digits

The “digits” here refer to the scale intervals for the connected weighing platform. If the interval is 1 g and 1000 digits are required, the minimum load is 1000 g (1000 intervals).

If the weighing platform interval is 5 g and the same number of digits as above are required, the minimum load is 5000 g.

When the load exceeds the minimum load limit, the weighing platform is tared automatically and/or a report printout is generated automatically; however, this requires the corresponding menu items are active for automatic taring (menu item 3.7.2) and for automatic printing (menu 7.15.2).

Automatic printing (*PROTOC* menu item 7.15):

When the menu item (7.15.2) is active, the first weight value that exceeds the minimum load is printed.

If the menu item is also activated for automatic taring, it is only tared when the minimum load is exceeded. In this case, an automatic printout would only be generated when the second weight value exceeds the minimum load.

Main scale: first platform displayed on start-up (Combics 2 only)

You can select the weighing platform to be displayed first when Combics is turned on in the Setup menu under “*UTILIT.*” (menu item 8.11.).

Entering a tare weight using a barcode scanner (Combics 2 only)

The tare weight of the container can be entered via a barcode scanner. To do this, the *TARE* setting must be activated in the menu under *SETUP / BARCODE*.

The value is applied and saved automatically, the **[Tare]** key does not have to be pressed. The content of the tare memory can be displayed in Info mode (**[Info]** key).

Entering the wRef application parameter using a barcode scanner

(Combics 2 only)

wRef application parameters can be entered via a barcode scanner. To do this, the *WREF* setting must be activated in the menu under *SETUP / BARCODE*. The value is applied and saved automatically, the **[REF]** key does not have to be pressed.

Entering Identifier using a barcode scanner (Combics 2 only)

Identifiers can be entered via a barcode scanner.

ID1: To do this, the *ID1* setting must be activated in the menu under *SETUP / BARCODE*. The value is applied and saved automatically, the **[ID]** key does not have to be pressed.

ID2 to ID6: To do this, the *HEADER* setting must be activated in the menu under *SETUP / BARCODE*. Then press the **[ID]** key until the desired ID entry appears, scan the barcode and save.

Displaying the content of the identifiers:

- **[ID]** key

Scanning barcodes directly

You can directly scan a barcode using the barcode scanner.

Menu setting: *SETUP / BARCODE / INPUT*

The barcode can contain the following codes:

- I for write identifier
- T for save tare memory
- R for write reference weight
- A for activate product data memory

Examples: “I4Anton” = write the character string to ID 4: Anton
 “TC1” = write 1 Kg to the preset tare memory.
 “C” = unit: Kilograms
 “B” = grams
 “D” = carat,
 etc.
 “RC0.0023” = write 0.0023 kg as the reference weight
 “A1” = load product data memory 1

Menu setting: *SETUP / BARCODE / HEADER*

The characters read from the barcode are shown in the weight value display.

Adjustment/Configuration counter for standard scales

Purpose Automatic recording of changes to adjustment and weighing parameters using two independent counters. The values remain saved for the life of the component.

- ▶ To display both counters, press and hold the $\rightarrow 0 \leftarrow$ key for longer than 2 seconds.
- ▷ The “Configuration counter” is then shown in the weight display for 3 seconds (identified by a P). Then the “Adjustment counter” is displayed for another 3 seconds (identified by a C). After 6 seconds, the information display turns off automatically.

Adjustment counter features:

- Counter limited to 9999
- Counter at “C 0000” for hardware commissioning
- Counter cannot be reset
- Counter is updated automatically when:
 - linearization, calibration/adjustment is successful
 - user calibration, adjustment or linearization weight is changed (menu 1.18.)
 - When the following parameters are changed:
 - Function of the CAL key (menu item 1.9.)
 - Zero setting range (menu item 1.11)
 - Tare/zero at power on (menu item 1.12)
 - The above parameters are reset to factory settings (menu item 9.1.1)

Configuration counter features:

- Counter limited to 9999
- Counter at “P 0000” for hardware commissioning
- Counter cannot be reset
- Counter is updated automatically when:
 - When the following parameters are changed:
 - Installation location (menu item 1.1.)
 - Application filter (menu item 1.2.)
 - Stability range (menu item 1.3.)
 - Taring (menu item 1.5)
 - Auto zero (menu item 1.6.)
 - Weight unit 1 (menu item 1.7.)
 - Weight unit 2 (menu item 3.1.)
 - Weight unit 3 (menu item 3.3.)
 - The above parameters are reset to factory settings (menu item 9.1.1)
 - Switching the Fn key to or from a 10-fold higher resolution
 - Turning the application automatic taring on/off (menu item 3.7.)
 - The application parameters are reset to factory settings (menu item 9.1.1)

Device Parameters

Password protection

Access to the device parameters *SETUP* and application parameters *APPLIC.* (Combics 2) can be password-protected against unauthorized changes in the Setup menu under *U-CODE* (see page 38).

Acoustic signal

An acoustic signal (single beep for active, double beep for inactive keys) is emitted when you press a key.

In the *SETUP* menu, the acoustic signal can be turned on/off under *UTILIT. / PARAMET(ER) / SIGNAL* (menu item 8.2.).

Keypad

The keypad can be blocked/released for entry in the *SETUP* menu under *UTILIT. / PARAMET(ER) / KEYS* (menu item 8.3.).

Automatic shutoff of Combics

In the *SETUP* menu, the indicator can be shut off automatically using a timer under *UTILIT. / PARAMET(ER) / AUTO.OFF* (menu item 8.7.).

Display lighting

The following settings can be made for display lighting in the *SETUP* menu under *UTILIT. / PARAMET(ER) / BACKLIT*:

- on (8.8.1)
- off (8.8.2)
- off automatically using a timer (8.8.3)

Timer

The timer for turning off the device and/or display lighting can be set to 2, 4, or 10 minutes in the *SETUP* menu under *UTILIT. / PARAMET(ER) / TIMER* (menu item 8.9.)

Example: Switch on the device, zero the scale, tare the container weight, place sample in the container, toggle display to gross weight or to second weight unit or 10-fold resolution



► Turn on the device.

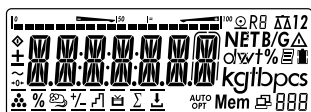

► All display segments appear (display test).

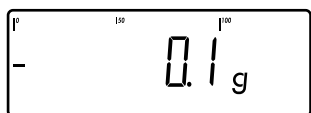

► The display for no load on the scale appears.



► Press the key to zero the scale.

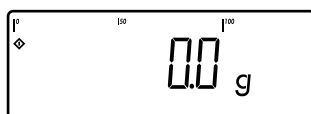

► The display for a zeroed scale appears.

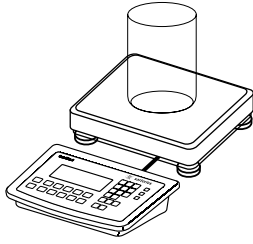

- ▶ Place the container on the weighing platform.

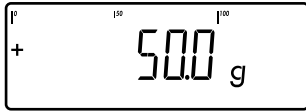

- ▷ The container weight is displayed.



- ▶ Press the key to tare the scale.

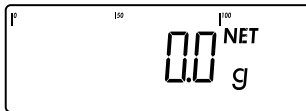

- ▷ The display for a tared scale with a container appears.

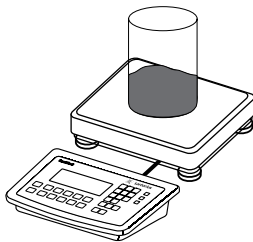

- ▶ Place a sample in the container (in this example 120.2 g)



- ▷ The display for a tared scale with weighing results appears.



- ▶ Press the key to toggle the display.

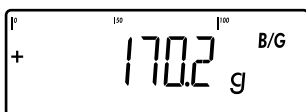

- ▷ The following is displayed depending on the configuration:
- ▷ The gross weight (in this example, 170.2 g = 50 g for container + 120.2 g for sample) (Combits 1)

or

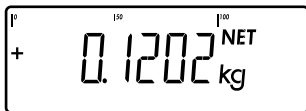

- ▷ Weight value display in 2nd weigh unit (in this example kg)

or

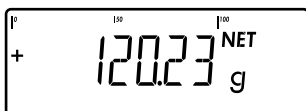

- ▷ Weight value display with 10-fold resolution
This display switches back automatically after 10 seconds.
(Combits 1)



- ▶ Press the key to return to the previous display.



▶ Net weight value display before it was switched.



▶ Press the  key to print a report.

ACE HARDWARE
GOETTINGEN
12.08.2012 15:10

Date and time for Combics 2 only

G# + 170.2 g
T + 50.0 g
N + 120.2 g

Example Combics 2: Weighing: Enter value for tare using the numeric keys; print results.



▶ Turn on the device.

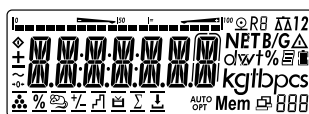

▶ All display segments appear (display test).

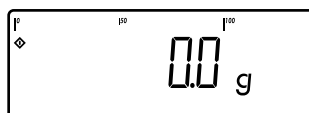

▶ The display for no load on the scale appears. When Combics 2 is turned on, it ready for weighing and zeros itself automatically. With no load on the scale, you can zero the weighing platform at any time by pressing .

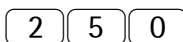

▶ Enter the tare weight in the current weight unit using the keypad (e.g., 250 g).

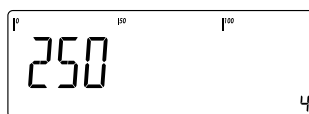

▶ Press the  key to save the tare value.

▶ Place the container on the scale.

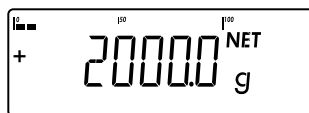
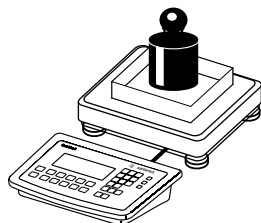

▶ The net weight value is displayed.



▶ Press the  key to display the gross weight.

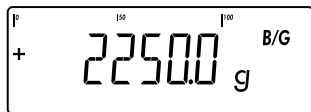

▷ The gross value is displayed.

You can toggle between the gross and net display using the **B/G** key.



▶ Press the **Print** key to print a report.

```

-----
24.08.2012      15:15
Type CW1NP1-30ED-LCE
Ser.no.      12345678
Vers.   C2 100.200810
BVers.      01-62-01
-----
ACE HARDWARE      Headers
GOETTINGEN
BATCH NO.      123456      Identifier 1
CUSTOMER       6.789      Identifier 2
24.08.2012      15:15
-----

G#      +      2250 g
T       +      0000 g
PT2     +      250 g
N       +      2000 g
-----
-----
24.08.2010      15:16
Name:
-----
-----
    
```

GMP header (only if GMP-compliant printout is configured, menu 7.13)

End of GMP header

GMP footer (only if GMP-compliant printout is configured)

End of GMP footer

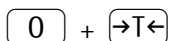

To delete the tare weight, enter **0** using the number block and press **→T←**.

Calibration, Adjustment

Purpose Perform **calibration** to determine the difference between the value displayed and the actual weight on the platform. Calibration does not entail making any changes within the weighing equipment.

During **adjustment**, the difference between the measured value displayed and the true weight of a sample is corrected, or is reduced to an allowable level within maximum permissible error limits.

Configuration for Use in Legal Metrology

M

Configuration of the weighing instrument for use in legal metrology is set by a switch. The switch is located on the back of the weighing platform and covered by a protective cap.

Using a verified scale in legal metrology in the EU:

The Type-Approval Certificate for verified scales is only valid for non-automatic weighing instruments. For automatic operation with or without additional, integrated equipment, please follow the applicable national regulations for the installation location.

Externally connected IS scales: Before use in legal metrology, the scale should be calibrated via the internal calibration equipment at the installation location: see the “Internal Calibration” section in this chapter.



The temperature range (°C) listed on the ID label should not be exceeded during operation.

For Servicing: External calibration for verified scales of accuracy class **III**

- External calibration is blocked in legal metrology (switch cover is sealed)
- External calibration is only possible by removing the seal. If the seal is broken, the validity of verification will become void and you must have your scale re-verified.

Using a verified scale in legal metrology with internal calibration equipment:

► Before use in legal metrology, the “internal calibration” function should be carried out at the installation location:

Open the menu access switch

The menu access switch is located on the back of the indicator right next to the weighing platform connection.

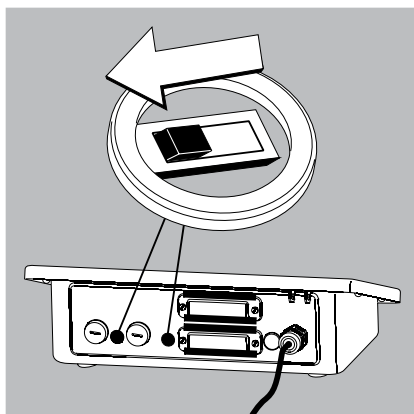

► Remove the cap.
► Slide the switch to the left (= “open” position, for use in legal metrology).



Features

Which of the following features are available depends on the connected weighing platform. These features are configured in the *SETUP* menu:

- External calibration/adjustment blocked in verified weighing instruments
- External calibration/adjustment with the default weight value or standard weight (not available on verified instruments): *SETUP / WP- / menu* Menu item 1.9. "Calibration, Adjustment."
- Specify the weight for external calibration/adjustment: *SETUP / WP- / menu* Menu item 1.18. "Entering Calibration Weight."
- Internal adjustment for IS weighing platforms (configure under: *COM 1* or *UNICOM / WP2*), Combics 2

- Block the  key to prevent use of the two functions described above: *SETUP / WP- / menu* Menu item 1.9. "Calibration, Adjustment."
- Calibrate first; then adjust automatically or manually (not for verified weighing instruments): *SETUP / WP- / menu* Menu item 1.10. "Calibration/Adjustment Sequence."
- Flashing  symbol as adjustment prompt. If more than one weighing platform is connected, the platform number is also displayed: *SETUP / WP- / menu* Menu item 1.15. "Calibration Prompt."
- Block external calibration/adjustment: *SETUP / WP- / menu* Menu item 1.16. "External Adjustment."

Example:

External calibration and manual adjustment with default weights (weighing parameters: factory settings)

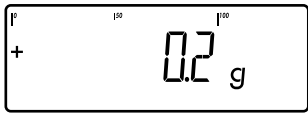

1.) Zero the scale.



2.) Start calibration (e.g., when adjustment prompt flashes *WP*).

CAL.EXT. is displayed for two seconds.



You are prompted to place the required weight on the platform (e.g., 10,000 g).

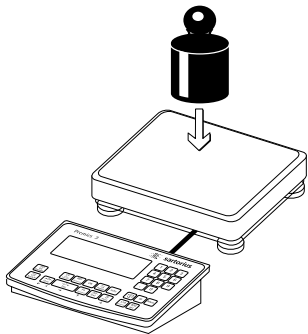

3.) Place the calibration/- adjustment weight on the weighing platform.

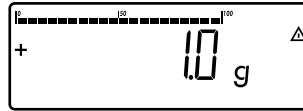
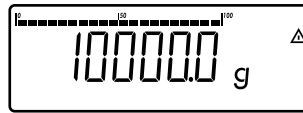

```
Ext. calibration
Nom. + 10000 g
Diff. + 1 g
```

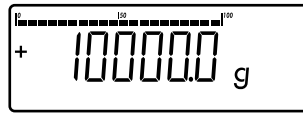



```
-----
24.02.2012 10:15
Type CAISL2
Ser.no. 12345678
Vers. 1.0103.11.2
BVers. 01-26-02
-----
```

```
Ext. calibration
Tar + 10000 g
Diff. + 1 g
Ext. adjustment
Diff. + 0 g
-----
```

```
24.02.2012 10:15
Name:
-----
```

The difference between the measured value and the true weight of the sample will be displayed with plus/minus signs.

A printout will be generated if the process is cancelled using the .

4.) Activate calibration adjustment (press the  key to cancel).

The adjustment weight is displayed once adjustment is finished.

A GMP-compliant printout is generated.

SQmin Function

Purpose To display the allowable minimum sample quantity “SQmin” (sample quantity minimum) in accordance with the United States Pharmacopoeia (USP). According to USP guidelines, the uncertainty of measurement may not exceed 0.1% of the sample quantity when substances are weighed with the highest degree of accuracy for volume determination. This additional function ensures that weighing results lie within defined tolerance limits corresponding to the requirements of your quality assurance system.

System Requirements The scale must be set up by a service technician to be able to use the SQmin function. The technician will determine the permitted minimum sample quantity and load this to your scale using the guidelines of your QA system. He will document this setting via a “Weighing module test as per USP” certificate in which the measurements and min. sample quantity are logged. The SQmin function ensures that the weighing results correspond to USP guidelines. These SQmin settings cannot be changed by the user.

- Features**
- Displaying the minimum sample quality: The value is displayed in the text line for 4 seconds after pressing the **[Fn]** key.
 - If the minimum sample quantity has not been reached: The **▲** symbol is displayed and weight values are marked with a “!” in the printout.
 - GLP header: The minimum sample quantity entered for SQmin can be included on the printout.

Setting SQmin parameters

The SQmin display must be turned on to use the SQmin function.

Menu: *SETUP / SQMIN /*

SQmin display: *DISPLAY* yes/no*

Print in GLP header: *GLP PRT.* yes/no*

* = Factory setting

SQmin operation

Example Determining sample weights while monitoring the minimum sample quantity
 (in this example, SQmin = 100 g)
 Configuration: The SQmin display must be turned on.



▶ Place the container for the sample on the scale and tare.

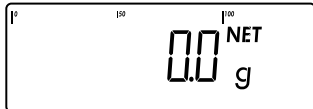

▶ Place the sample on the scale.

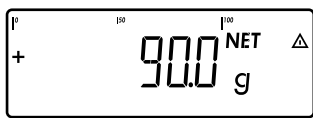

▷ The minimum sample quantity is not reached (symbol Δ).



▶ Print the weight value.

I N + 90.0 ! I

▶ Place another sample on the scale.

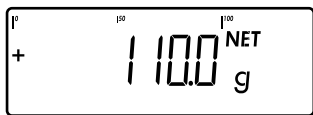

▷ The minimum sample quantity is exceeded.



▶ Print the weight value.

I N + 110.0 g I



▶ Briefly press the Fn key to toggle between the measured value and SQmin value.

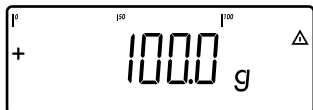

▷ The value for the minimum sample quantity is displayed for four seconds.

Data ID Codes

This function is only available for Combics 2.

You can assign codes (such as product name, batch number, etc.) for identification of measured values on printouts.

- Features**
- Assign up to six ID codes.
 - Assign both a name and a value to each ID code.
 - Displaying individual IDs: press the **ID** key
 - The name is left-justified and the value is right-justified on the printout. If the entire code is too long for one line, additional lines are printed.
 - Enter ID code names in the Setup menu under:
SETUP / PRTPROT, menu item 7.4.
The name can have a max. of 20 characters.
 - Enter up to 40 characters for the value of the ID code. Press the **ID** key to activate the input mode.
 - Individual characters of the ID can be deleted using the **CF** key.
 - If both the name and value fields are empty, no ID code is printed.
 - In the Setup program, you can configure when and whether ID codes are printed (see “Configuring Printouts” page 96).

Settings for individual ID codes

Menu: *SETUP / PRINT / PROTOC. / HEADLIN.*





























Factory settings for ID code names:

```
ID1:  ID1
ID2:  ID2
ID3:  ID3
ID4:  ID4
ID5:  ID5
ID6:  ID6
```

There are no factory settings for ID code values.

Using individual ID codes

Example Enter ID code names. “Batch number” and “Customer” should be entered for ID 1 and ID 2.

-  ...  ► Open menu (see page 35) .
-   ...  ► Select and open *SETUP*.
-   ...  ► Select and open *PRINT*.
-  ► Open *PROTDC..*
-  ► Open *HEADLIN..*
-   ...  ► Select and open *ID 1*.
-   ... ► Enter a name for the first ID (using the  and  keys or use the number block), e.g. “batch number.”
-  ► To save the entry, press the  key.
-  ...  ► Select and open *ID 2*.
-   ... ► Enter a name for the 2nd ID, e.g. “customer.”
-  ► To save, press the  key.
-   ... ► To exit the sub-menu, press the  key several times.

Application Programs

Overview of applications and functions

	Combiics 1	Combiics 2
Keys	6 keys	17 keys plus numeric keypad
Display	14-segment	14-segment plus pictograms
Application		
Basic weighing	X	X
Send print job/data record to peripheral device	X	X
Label printer	X	X
Connection option for second scale	–	X
Counting	–	X
Neutral measurement	–	X
Averaging (animal weighing)	–	X
Weighing in percent	–	X
Checkweighing	–	X
Classification	–	X
Totalizing	–	X
Batching/Counting to target value	–	X
Product data memory	–	X
Function		
Zero	X	X
Tare	X	X
Date/time	–	X
Internal battery (rechargeable)	Optional	Optional
ID codes (6 codes, 40 characters each)	–	X
Barcode	–	Optional
Automatic printout	X	X
Automatic taring	X	X
Manual taring	–	X
Analog data output	Optional	Optional
Selectable control inputs	X	X
Electronically isolated control inputs and outputs	Optional	Optional
Unit conversion	X	X
Increased resolution	X	X
GMP-compliant printout	X	X



Combination of applications see page 93.

Counting (Combi 2):

With the Counting application, you can determine the number of parts which each have approximately equal weight (*APPLIC. 1* menu).

- Features**
- Save the reference weight “wRef” from the weighing platform
 - Enter the average piece weight “wRef” via the keypad
 - Enter the reference sample quantity “nRef” via the keypad
 - Enter reference sample weight using a barcode scanner
 - Automatic reference sample updating
 - Counting with two weighing platforms
 - Activate Info mode via the **Info** key
 - Toggle the display between quantity and weight via the **↔** key
 - Define the level of accuracy (display resolution) applied when a calculated reference sample quantity is saved
 - Automatic taring of container weight.
Setting: *APPLIC. / AUT.TARE*, menu item 3.7
 - Automatic initialization when the scale is switched on. The indicator is initialized with the most recently used values for reference sample quantity “nRef” and reference sample weight “wRef.”
Setting: *APPLIC. / AUT.START*, menu item 3.8

Exit application, delete parameters

The value of the reference sample weight in the reference memory remains active until it is deleted via the **CF** key or overwritten or until the application is changed. The reference sample weight also remains saved after the scale is turned off. You can assign different functions to the **CF** key for deleting applications. When you clear applications, you can delete either the data stored for all applications or just selected data stored for the active application.
Setting: *APPLIC. / CLER.CF* menu item 3.24

Tare function:

If you store a tare (weight value) by pressing the **↔T←** key, you can later enter a tare value manually. The tare value you enter is added to the stored tare value.
Setting: *APPLIC. / TARE.FNC* menu item 3.25.1 (factory setting)

A tare value entered manually overwrites a stored tare value (weight value). If you enter a tare value manually, a tare value (weight value) stored later overwrites the manually entered value. Setting: *APPLIC. / TARE.FNC* menu item 3.25.2

Restore factory default settings: *APPLIC./RESET* menu item 9.1.

Average piece weight

Before the quantity on the platform can be calculated, the average piece weight must be entered in the application. There are several ways to enter this value in the program:

Calculating the reference piece weight

- Place the number of parts defined as the reference sample quantity on the weighing platform and calculate the average piece weight by pressing the **OK** key.
or
 - Place any number of parts on the connected weighing platform, enter the quantity using the keypad and select and calculate by pressing the **REF** key.
- How the reference weight is calculated depends on the application setting for resolution. The value is either rounded off in accordance with the display resolution, or saved with 10-fold or 100-fold resolution.

Entering the reference piece weight

The reference piece weight (i.e., the weight of one piece) can be entered using the keypad and save with the **OK** key.

Reading the reference piece weight

The reference piece weight can be read using a barcode scanner.



The entered value remains active until deleted by pressing the **CF** key or until overwritten by a new value. It remains saved after the scale is switched off.

Preparation ► Open the *APPLIC./APPLIC.1/COUNT.* menu.

Available parameter settings * = Factory setting

<i>MIN.INIT</i>	Minimum load for initialization	3.6
<i>1 DIGIT</i>	1 digit*	3.6.1
<i>2 DIGIT</i>	2 digits	3.6.2
<i>5 DIGIT</i>	5 digits	3.6.3
<i>10 DIGT.</i>	10 digits	3.6.4
<i>20 DIGT.</i>	20 digits	3.6.5
<i>50 DIGT.</i>	50 digits	3.6.6
<i>100 DIG.</i>	100 digits	3.6.7
<i>200 DIG.</i>	200 digits	3.6.8
<i>500 DIG.</i>	500 digits	3.6.9
<i>1000 DI.</i>	1000 digits	3.6.10
<i>RESOLUT</i>	Resolution for calculation of reference value	3.9.
<i>DISP.ACC</i>	Display accuracy*	3.9.1
<i>10 FOLD</i>	Display accuracy + 1 decimal place	3.9.2
<i>100 FOLD</i>	Display accuracy + 2 decimal places	3.9.3
<i>SAVE.WT.</i>	Parameter for saving weight values	3.11
<i>STABIL.</i>	With stability*	3.11.1
<i>ACC.STAB</i>	With increased stability	3.11.2
<i>REF.UPDT</i>	Reference sample updating .	3.12.
<i>OFF</i>	Off	3.12.1
<i>AUTOMAT</i>	Automatic*	3.12.3
<i>REF.WP</i>	Reference weighing instrument	3.13.
<i>NO WP</i>	No weighing platform selected	3.13.1*
<i>WP 1</i>	Weighing platform WP1	3.13.2
<i>WP 2</i>	Weighing platform WP2	3.13.3



► To save the setting, press the **↵** key.

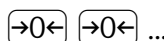

► To exit setup: Press the **↵** key several times.

Minimum load for initialization

You can set the minimum load here, i.e. the load that must be placed on the weighing platform in order to carry out the application. If the load on the platform is too light, the following will occur:

- Error code *INF 29* appears,
- The weighing platform is not initialized,
- The preset reference sample quantity is saved.

Setting: *APPLIC./APPLIC.1/COUNT./MIN.INIT* menu item 3.6.

The minimum load can be set in 10 steps from 1 to 1000 digits (see available parameters). The “digits” here refer to the scale intervals for the connected weighing platform. If the interval of the connected platform is 1 g, for example, and 1000 digits are required, you must place at least 1000 g (= 1000 intervals = 1000 digits) on the weighing platform for initialization.

Resolution The resolution indicates the accuracy used to determine the reference weight. The default setting is “display resolution.” The resolution is increased when “10-fold” or “100-fold” is selected. “10-fold” increases the resolution of the net value by one step (display resolution x 10), “100-fold” increases it two steps (display resolution x 100).
Setting: *APPLIC./APPLIC. 1/COUNT./RESOLUT* menu item 3.9.

Parameter for saving weight values The weight on the platform is saved as a reference value as soon as the platform has stabilized. “Stability” is defined as the point at which the fluctuation of a measured value lies within a defined tolerance. The narrower the tolerance, the more stable the platform is at “stability”.
The “increased stability” setting has a lower tolerance so that the average piece weight saves is more accurate and the results more reproducible; however, the measurement time can take longer.
Setting: *APPLIC./APPLIC. 1/COUNT./SAVE WT.* menu item 3.11.

Reference sample updating You can define whether or not the reference sample weight is updated automatically during weighing using this setting. The reference sample weight is updated automatically only when the following criteria are met:

1. “Automatic” must be set for reference sample updating in the menu.
2. The current piece count exceeds the original piece count by at least two.
3. The current piece count cannot be more than double the size of the original piece count. This limitation does not apply to the first update if the piece weight was entered via a barcode scanner or keypad.
4. The current piece count is less than 1000.
5. The internally calculated piece count (such as 17.24 pcs) differs by less than ± 0.3 pcs from the nearest whole number (in this example: 17).
6. The weighing platform is stable in accordance with the parameter defined for saving weights.

If automatic reference sample updating is selected in the menu and the piece count (pcs) is displayed, the *AUTO* symbol is displayed below the bar graph. If the average piece weight has been updated since you began weighing, the text line shows the *OPT* symbol. During an updating operation, *OPT* and the updated piece count are displayed briefly in the measured value line. The new reference sample weight and reference sample quantity are saved.
Setting: *APPLIC./APPLIC. 1/COUNT./REF.UPT* menu item 3.12.

Counting with Two Weighing Platforms You can use two weighing platforms simultaneously with the Counting application. When using two platforms, you can choose from the following operating modes:

- Counting with two platforms of the same type
- Counting with one reference platform and one weighing platform

Counting with two platforms of the same type
Use this mode to count different types of sample material with different weights. For example, count the lighter-weight pieces on one platform and the heavier pieces on another. You can define one of the two scales as the reference scale. The reference scale is the first scale active when you switch on the device, regardless of the setting for automatic initialization of the Counting application.

Counting with one reference platform and one weighing platform
In this operating mode, the reference platform is a high-resolution weighing platform with a relatively low maximum capacity. The other platform is used for weighing heavier samples, and has a high capacity with a relatively low resolution. This allows you to both determine the reference sample weight with high resolution; i.e., very precisely, and to count large amounts of parts, without requiring an expensive high-resolution, high-capacity weighing platform.

The system can be configured to switch automatically to the reference platform for initialization (the measured value line shows *REF*). Following initialization, you can switch to the counting platform.

Setting: *APPLIC./APPLIC. 1/COUNT./REF.WP* menu item 3.13.



If automatic reference sample updating is enabled, the update is performed on the active platform; in other words, the system does not automatically switch to the reference platform.

Example: You need to determine an unknown number of parts and the measurements should be logged.
Configuration: The “Counting” application is selected, and printout has been set up.

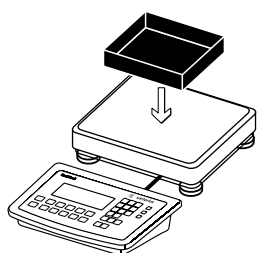

- Place empty container on the scale.



- Tare the scale.
This is not required if the automatic tare function is active. The tare weight is saved automatically when you place the container on the platform.

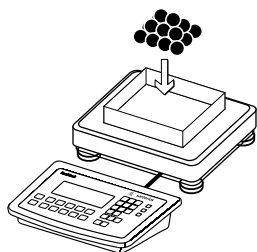

- Place a number of parts in the container for the reference quantity (in this example, 20 pcs).



- Enter the number of parts using the keypad.



- Start the calculation of the reference piece weight.



- Set the number of reference parts using **REF**: 1, 2, 5, 10, 20, etc.



- Start the calculation of the reference piece weight.



- Add a quantity of uncounted parts to the container.

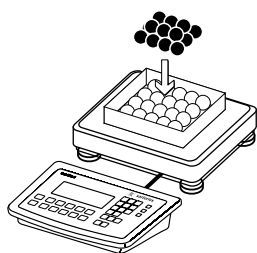

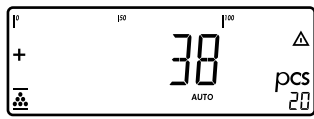

▷ The result is displayed.

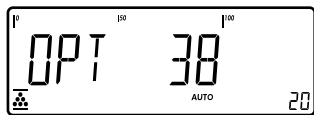

▷ If automatic reference sample updating is enabled, *OPT* appears in the display.



▶ Print results (Configuring Printouts see page 96).

nRef	+	38	pcs
wRef	+	0.003280	kg
G#	+	0.373	kg
T	+	0.248	kg
N	+	0.125	kg

Qnt		38	pcs

Neutral Measurement (CombiCS 2)

With this application you can measure the length, surface and volume of parts that have roughly the same specific weight. The ρ symbol is displayed as the unit (menu *APPLIC. 1*).

- Features**
- Save the reference weight “wRef” from the weighing platform:
 - Enter the reference weight “wRef” through the keypad
 - Enter the factor for calculation “nRef” using the keypad
 - Enter reference sample weight using a barcode scanner
 - Measuring with two weighing platforms
 - Activate Info mode with the **Info** key
 - Toggle the display between measurement and weight via the **5** key
 - The level of accuracy (display resolution) can be set when the calculated reference weight is applied
 - Automatic taring of container weight
Setting: *APPLIC. / AUT.TARE*, menu item 3.7
 - Automatic initialization when the scale is switched on. The indicator is initialized with the most recently used values for reference sample quantity “nRef” and reference sample weight “wRef.”
Setting: *APPLIC. / AUT.START*, menu item 3.8

Exit application, delete parameters

The value of the reference sample weight in the reference memory remains active until it is deleted via the **CF** key or overwritten or until the application is changed. The reference sample weight also remains saved after the scale is turned off. You can assign different functions to the **CF** key for deleting applications. When you clear applications, you can delete either the data stored for all applications or just selected data stored for the active application.
Setting: *APPLIC. / CLEAR.CF* menu item 3.24

Tare function:

If you store a tare (weight value) by pressing the **T←** key, you can later enter a tare value manually. The tare value you enter is added to the stored tare value.
Setting: *APPLIC. / TARE.FNC* menu item 3.25.1 (factory setting)

A tare value entered manually overwrites a stored tare value (weight value). If you enter a tare value manually, a tare value (weight value) stored later overwrites the manually entered value.
Setting: *APPLIC. / TARE.FNC* menu item 3.25.2

Restore factory default settings: *APPLIC. / RESET* menu item 9.1.

Reference weight

In order to calculate the length, surface or volume of a given sample, the average weight of a reference quantity of the sample must be known (in the example below, the reference is 1 meter of electrical cable). There are different ways to enter the reference weight:

Calculating the reference weight

- Place the reference quantity (defined by the calculation factor) on the connected weighing platform and calculate the reference sample weight by pressing the **OK** key.
- or
- Place any amount of the sample material on the connected weighing platform, enter the calculation factor through the keypad, and press the **REF** key to calculated reference sample weight.

How the reference weight is calculated depends on the application setting for

resolution. The resolution settings are either display resolution, display resolution 10-fold or display resolution 100-fold.

Entering the reference weight

The reference weight (e.g., the weight of one meter of electrical cable) can be entered using the keypad and saved by pressing the **OK** key.

Reading the reference piece weight

The reference weight can be read using a barcode scanner.



The entered value remains active until deleted by pressing the **CF** key or until overwritten by a new value. It remains saved after the scale is switched off.

Preparation

► Open the *APPLIC. / APPLIC. 1 / NEUTR.M* menu.

Available parameter settings

* = Factory setting

<i>MIN.INIT</i>	Minimum load for initialization	3.6
<i>1 DIGIT</i>	1 digit	3.6.1*
<i>2 DIGIT</i>	2 digits	3.6.2
<i>5 DIGIT</i>	5 digits	3.6.3
<i>10 DIGT.</i>	10 digits	3.6.4
<i>20 DIGT.</i>	20 digits	3.6.5
<i>50 DIGT.</i>	50 digits	3.6.6
<i>100 DIG.</i>	100 digits	3.6.7
<i>200 DIG.</i>	200 digits	3.6.8
<i>500 DIG.</i>	500 digits	3.6.9
<i>1000 DI.</i>	1000 digits	3.6.10
<i>RESOLUT</i>	Resolution for calculation of reference value	3.9.
<i>DISP.ACC</i>	Display accuracy	3.9.1*
<i>10 FOLD</i>	Display accuracy + 1 decimal place	3.9.2
<i>100 FOLD</i>	Display accuracy + 2 decimal places	3.9.3
<i>DEC.PLCS</i>	Decimal places in displayed result	3.10
<i>NONE</i>	None	3.10.1*
<i>1 DEC.PL</i>	1 decimal place	3.10.2
<i>2 DEC.PL</i>	2 decimal places	3.10.3
<i>3 DEC.PL</i>	3 decimal places	3.10.4
<i>SAVE.WT.</i>	Parameter for saving weight values	3.11
<i>STABIL.</i>	With stability	3.11.1*
<i>ACC.STAB</i>	With increased stability	3.11.2
<i>REF.WP</i>	Reference weighing instrument	3.13.
<i>NO WP</i>	No weighing platform selected	3.13.1*
<i>WP 1</i>	Weighing platform WP1	3.13.2
<i>WP 2</i>	Weighing platform WP2	3.13.3



► To save the setting, press the **→T←** key.



...

► To exit setup: Press the **→0←** key several times.

- Minimum load for initialization** You can set the minimum load here, i.e. the load that must be placed on the weighing platform in order to carry out the application. If the load on the platform is too light, the following will occur:
- Error code *INF 29* appears,
 - The weighing platform is not initialized,
 - The preset reference sample quantity is saved.
- Setting: *APPLIC./APPLIC. 1/NEUTR.M/MIN.INIT* menu item 3.6.
- The minimum load can be set in 10 steps from 1 to 1000 digits (see available parameters). The “digits” here refer to the scale intervals for the connected weighing platform. If the interval of the connected platform is 1 g, for example, and 1000 digits are required, you must place at least 1000 g (= 1000 intervals = 1000 digits) on the weighing platform for initialization.
- Resolution** The resolution indicates the accuracy used to determine the reference weight. The default setting is “display resolution.” The resolution is increased when “10-fold” or “100-fold” is selected. “10-fold” increases the resolution of the net value by one step (display resolution x 10), “100-fold” increases it two steps (display resolution x 100).
- Setting: *APPLIC./APPLIC. 1/NEUTR.M/RESOLUT* menu item 3.9.
- Decimal Places** In neutral measurement, not only whole numbers but also decimal numbers (for example, 1.25 or electrical cabling) can be displayed. The number of decimal places displayed can range from none up to 3 places.
- Setting: *APPLIC./APPLIC. 1/NEUTR.M/DEC.PLCS* menu item 3.10.
- Parameter for saving weight values** The weight on the platform is saved as a reference value as soon as the platform has stabilized. “Stability” is defined as the point at which the fluctuation of a measured value lies within a defined tolerance. The narrower the tolerance, the more stable the platform is at “stability”.
- The “increased stability” setting has a lower tolerance so that the average piece weight saved is more accurate and the results more reproducible; however, the measurement time can take longer.
- Setting: *APPLIC./APPLIC. 1/NEUTR.M/SAVE WT.* menu item 3.11.
- Measuring with two weighing platforms** You can use two weighing platforms simultaneously with the Neutral Measurement application. When using two platforms, you can choose from the following operating modes:
- Counting with two platforms of the same type
 - Counting with one reference platform and one weighing platform
- Neutral measurement with two weighing platforms**
Use this mode to measure different types of sample material with different weights. For example, measure the lighter-weight samples on one platform and the heavier samples on another. You can define one of the two scales as the reference scale. The reference scale is the first scale active when you switch on the device, regardless of the setting for automatic initialization of the Neutral Measurement application.
- Neutral measurement with one reference platform and one weighing platform**
In this operating mode, the reference platform is a high-resolution weighing platform with a relatively low maximum capacity. The other platform is used for weighing heavier samples, and has a high capacity with a relatively low resolution. This allows you to both determine the reference piece weight with high resolution; i.e., very precisely, and to measure large samples, without requiring an expensive high-resolution, high-capacity weighing platform.
- The system can be configured to switch automatically to the reference platform for initialization (the measured value line shows *REF*). Following initialization, you can switch to the counting platform.

Example: 25 m of electrical cable is to be measured.
Configuration: The “Neutral Measurement” application is selected, and printout has been set up (see “Configuration”).

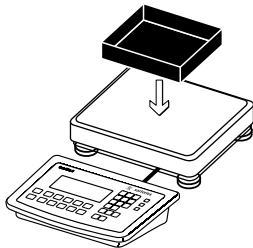

- ▶ Place empty container on the scale.



- ▶ Tare the scale.
 This is not required if the automatic tare function is active. The tare weight is saved automatically when you place the container on the platform.

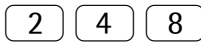

- ▶ Enter the weight of 1 meter of cable using the keypad (in this example, 248 g).



- ▶ Save the value entered.

or



- ▶ Set the number of reference parts using (REF): 1, 2, 5, 10, 20, etc.



- ▶ Start the calculation of the reference piece weight.

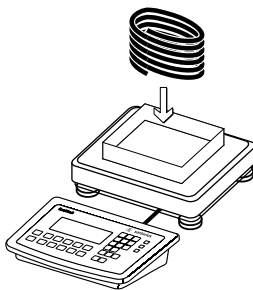

- ▶ Place the desired amount of cable into the container (25 m in this example).

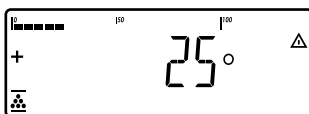

- ▶ The result is displayed.



- ▶ Print results (Configuring Printouts: see page 96)

nRef	+	1	o
wRef	+	0.248	kg
G#	+	6.794	kg
T	+	0.541	kg
N	+	6.253	kg
Qnt		25	o

Averaging (Animal Weighing) (Combics 2)

With this application, you can calculate averages from several weighing operations. It is used when either the object to be weighed (e.g. animals) or the environment during weighing are unstable. Selection and settings in the *Applic. / APPLIC. 1 / ANIM.WG* menu.

- Features**
- Averaging started manually or automatically (.../START menu item 3.18).
With manual start selected, the averaging routine begins when you press a key (provided the start conditions are met).
With automatic start selected, the application begins when you place the first load on the platform (provided the start conditions are met).
 - Enter the number of sub-weighing operations using the keypad
 - Use the (REF) key to select the number of measurements for averaging
 - Activate Info mode via the (Info) key
 - Toggle the display from “result of last measurement” to “current weight” by pressing the (↺) key
 - Automatic results printout (.../PRINT menu item 3.20).
 - Automatic taring of container weight (APPLIC./AUT.TARE menu item 3.7).
 - Automatic start of averaging when the scale is turned on and a sample placed on the platform (provided start conditions are met, APPLIC./AUT.START menu item 3.8).

Exit application, delete parameters

The value of the reference sample weight in the reference memory remains active until it is deleted via the (CF) key or overwritten or until the application is changed. The reference sample weight also remains saved after the scale is turned off.

You can assign different functions to the (CF) key for deleting applications. When you clear applications, you can delete either the data stored for all applications or just selected data stored for the active application.

Setting: *APPLIC./CLEAR.CF* menu item 3.24

Tare function:

If you store a tare (weight value) by pressing the (↵) key, you can later enter a tare value manually. The tare value you enter is added to the stored tare value.

Setting: *APPLIC./TARE.FNC* menu item 3.25.1 (factory setting)

A tare value entered manually overwrites a stored tare value (weight value). If you enter a tare value manually, a tare value (weight value) stored later overwrites the manually entered value.

Setting: *APPLIC./TARE.FNC* menu item 3.25.2

Restore factory default settings: *APPLIC./RESET* menu item 9.1.

Number of measurements for average

You can enter the desired number of weight measurements to determine the average using the keypad. This value remains active until it is overwritten by another value. It also remains in memory when you switch to a different application program, or turn off the scale.

Application start

There are three ways to start the averaging routine:

- Manual start with preset number of sub-weighing operations: Place the sample on the platform and press the (OK) key
- Manual start with user-defined number of sub-weighing operations: Place the sample on the platform and enter the number of weighing operations using the keypad. Press the (REF) key to save the number entered and begin weighing.
- Automatic start with preset number of sub-weighing operations: Measurement begins when you place the first sample on the platform, provided the start conditions are met.



Preparation

- Open the *APPLIC./APPLIC. 1/ANIM.WG* menu.

Available parameter settings

* = Factory setting

<i>MIN.INIT</i>	Minimum load for initialization	3.6
<i>1 DIGIT</i>	1 digit*	3.6.1
<i>2 DIGIT</i>	2 digits	3.6.2
<i>5 DIGIT</i>	5 digits	3.6.3
<i>10 DIGT.</i>	10 digits	3.6.4
<i>20 DIGT.</i>	20 digits	3.6.5
<i>50 DIGT.</i>	50 digits	3.6.6
<i>100 DIG.</i>	100 digits	3.6.7
<i>200 DIG.</i>	200 digits	3.6.8
<i>500 DIG.</i>	500 digits	3.6.9
<i>1000 DI.</i>	1000 digits	3.6.10
<i>START</i>	Start of averaging	3.18.
<i>MANUAL</i>	Manual*	3.18.1
<i>AUTOMAT</i>	Automatic	3.18.2
<i>ACTIVITY</i>	Animal activity	3.19.
<i>0.1 PERC.</i>	0.1% of animal/object	3.19.1
<i>0.2 PERC.</i>	0.2% of animal/object*	3.19.2
<i>0.5 PERC.</i>	0.5% of animal/object	3.19.3
<i>1 PERC.</i>	1% of animal/object	3.19.4
<i>2 PERC.</i>	2% of animal/object	3.19.5
<i>5 PERC.</i>	5% of animal/object	3.19.6
<i>10 PERC.</i>	10% of animal/object	3.19.7
<i>20 PERC.</i>	20% of animal/object	3.19.8
<i>50 PERC.</i>	50% of animal/object	3.19.9
<i>100 PERC.</i>	100% of animal/object	3.19.10
<i>PRINT</i>	Autom. printout of results	3.20.
<i>MANUAL</i>	Off*	3.20.1
<i>AUTOMAT</i>	On	3.20.2
<i>DIS.UNL</i>	Static display of result after load removed	3.21.
<i>CLEAR</i>	Display is fixed until unload threshold reached*	3.21.1
<i>PRESENT</i>	Fixed display until [CF] is pressed	3.21.2

-  ► To save the setting, press the **[T]** key.
-   ... ► To exit setup: Press the **[0]** key several times.

Minimum load for initialization

You can set the minimum load here, i.e. the load that must be placed on the weighing platform in order to carry out the application. If the load on the platform is too light, the following will occur:

- Error code *INF 29* appears,
- The weighing platform is not initialized,
- The preset reference sample quantity is saved.

Setting: *APPLIC./APPLIC. 1/ANIM.WG/MIN.INIT* menu item 3.6.

The minimum load can be set in 10 steps from 1 to 1000 digits (see available parameters). The “digits” here refer to the scale intervals for the connected weighing platform. If the interval of the connected platform is 1 g, for example, and 1000 digits are required, you must place at least 1000 g (= 1000 intervals = 1000 digits) on the weighing platform for initialization.

Starting the Measurements

The averaging routine does not begin until the fluctuation in weight value remains below a defined threshold over three consecutive measurements. The tolerance limit is defined as a percentage of the animal or object weight (for example, 0.1%, 0.2%,

..., 50%, 100%), configured in Setup under: *ACTIVITY* menu item 3.19.

If the “Averaging” parameter is set to 2%, for example, and the animal or object weighs 10 kg, measurement does not begin until the fluctuation in weight value remains below 200 g during three consecutive measurements.

Display A calculated average value is shown continuously on the main display. The Δ symbol indicates the calculated value.

You can toggle between the results display and the current scale display by pressing the \square key.

Setting: *APPLIC./APPLIC. 1/ANIM.WG/DIS.UNL* menu item 3.21.

You can select “Display is static until unload threshold reached” to have the display switch automatically to the weight readout when you unload the weighing platform (i.e., when the load is less than half the minimum load). The result of the most recent averaging operation is not saved.

If you select “Display is static until the \square key is pressed,” the calculated average remains displayed even after the weighing platform is unloaded, until you press the \square key to begin a new measurement.

The weight of one mouse should be measured.

Configuration: The “Animal Weighing” application is selected, and printout has been set up (see “Configuration”).

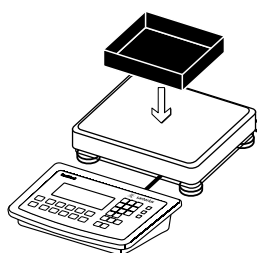

- ▶ Place empty container on the scale.

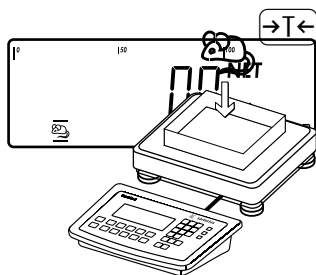

- ▶ Tare the scale.
This is not required if the automatic tare function is active. The tare weight is saved automatically when you place the container on the platform.

- ▶ Place the mouse in the container.





- ▶ Enter the number of sub-weighing operations using the keypad (in this example, 20 measurements).



- ▶ Save the value entered and start the averaging.

or

-  ► Set the number of reference parts using : 1, 2, 5, 10, 20, etc.
-  ► Start the calculation of the reference piece weight.

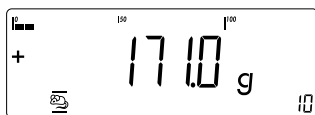

The averaging routine does not begin until the fluctuation in weight value remains below a defined threshold over three consecutive measurements. The number of sub-weighing operations remaining is shown in the numeric display.

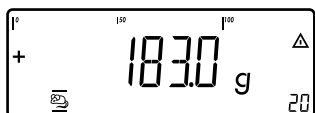

- The averaging result is displayed.



- Print the results.

Note: If automatic printout of results is enabled, you do not need to press the  key. The results are printed automatically.

Printout configuration: see page 96.

```
mDef +      20
T      +    0.292 kg
x-Net +    0.183 kg
-----
```

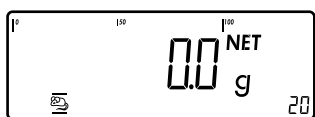

- When you unload the weighing platform, the display switches to the weight readout automatically, unless configured otherwise in the menu. The weighing instrument is ready for the next measurement.

Weighing in Percent % (Combies 2)

With this application, you can use your weighing platform to obtain weight readouts in percent which are in proportion to a reference weight. % is displayed as the weight unit. Selection and settings in the *APPLIC./APPLIC.1/PERCENT* menu.

- Features**
- Save the current weight value as reference weight “pRef”
 - Enter the reference weight “Wxx%” for 100% using the keypad
 - Enter the reference percentage “pRef” using the keypad
 - Enter reference sample weight using a barcode scanner
 - Display result as loss (difference) or residue
 - Display up to 3 decimal places (menu item 3.10)
 - Weighing in percent with two weighing platforms
 - Activate Info mode via the **Info** key
 - Toggle between percent display and weight display using the **↔** key.
 - Automatic taring of container weight (*APPLIC./AUT./AUT.TARE* menu item 3.7).
 - Automatic initialization when the scale is switched on. The application is initialized with the most recently saved data (*APPLIC./AUT.START* menu item 3.8)

Exit application, delete parameters

The value of the reference sample weight in the reference memory remains active until it is deleted via the **CF** key or overwritten or until the application is changed. The reference sample weight also remains saved after the scale is turned off.

You can assign different functions to the **CF** key for deleting applications. When you clear applications, you can delete either the data stored for all applications or just selected data stored for the active application.

Setting: *APPLIC./CLEAR.CF* menu item 3.24

Tare function:

If you store a tare (weight value) by pressing the **↔T←** key, you can later enter a tare value manually. The tare value you enter is added to the stored tare value. Setting: *APPLIC./TARE.FNC* menu item 3.25.1 (factory setting)

A tare value entered manually overwrites a stored tare value (weight value). If you enter a tare value manually, a tare value (weight value) stored later overwrites the manually entered value.

Setting: *APPLIC./TARE.FNC* menu item 3.25.2

Restore factory default settings: *APPLIC./RESET* menu item 9.1.

To determine the weight of a sample relative to a reference weight, you need to define the reference percentage value. There are different ways to enter this value in the application:

Calculating the reference percentage value

- Place the reference quantity (defined by the reference percentage value) on the connected weighing platform and press the **OK** key to initialize the application.
- or
- Place any amount of the sample material on the connected weighing platform, enter the reference percentage value through the keypad, and press the **REF** key to initialize the application.

How the reference weight is calculated depends on the application setting that defines “Accuracy for saving weights”. The value is either rounded off in accordance with the display resolution, saved with 10-fold or 100-fold resolution.

Entering the reference percentage value

The reference weight for 100% is entered using the keypad and the **OK** key is pressed to initialize the application.

Reading the reference percentage value

The reference weight can be read using a barcode scanner.



The entered value remains active until deleted by pressing the **CF** key or until overwritten by a new value. It remains saved after the scale is switched off.

Preparation ► Open the *APPLIC. / APPLIC. 1 / PERCENT* menu

Available parameter settings

* = Factory setting

<i>MIN.INIT</i>	Minimum load for initialization	3.6
<i>1 DIGIT</i>	1 digit*	3.6.1
<i>2 DIGIT</i>	2 digits	3.6.2
<i>5 DIGIT</i>	5 digits	3.6.3
<i>10 DIGIT.</i>	10 digits	3.6.4
<i>20 DIGIT.</i>	20 digits	3.6.5
<i>50 DIGIT.</i>	50 digits	3.6.6
<i>100 DIG.</i>	100 digits	3.6.7
<i>200 DIG.</i>	200 digits	3.6.8
<i>500 DIG.</i>	500 digits	3.6.9
<i>1000 DI.</i>	1000 digits	3.6.10
<i>RESOLUT</i>	Resolution for calculation of reference value	3.9.
<i>DISP.ACC</i>	Display accuracy	3.9.1*
<i>10 FOLD</i>	Display accuracy + 1 decimal place	3.9.2
<i>100 FOLD</i>	Display accuracy + 2 decimal places	3.9.3
<i>DEC.PLCS</i>	Decimal places in displayed result	3.10
<i>NONE</i>	None	3.10.1*
<i>1 DEC.PL</i>	1 decimal place	3.10.2
<i>2 DEC.PL</i>	2 decimal places	3.10.3
<i>3 DEC.PL</i>	3 decimal places	3.10.4
<i>SAVE.WT.</i>	Parameter for saving weight values	3.11
<i>STABIL.</i>	With stability	3.11.1*
<i>ACC.STAB</i>	With increased stability	3.11.2
<i>REF.WP</i>	Reference weighing instrument	3.13.
<i>NO WP</i>	No weighing platform selected	3.13.1*
<i>WP 1</i>	Weighing platform WP1	3.13.2
<i>WP 2</i>	Weighing platform WP2	3.13.3
<i>CALC.DIS</i>	Display of calculated value	3.15.
<i>RESID.DT</i>	Residual quantity	3.15.1*
<i>LOSS</i>	Loss	3.15.2



► To save the setting, press the **→T←** key.

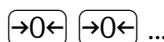

...

► To exit setup: Press the **→0←** key several times.

Minimum load for initialization

You can set the minimum load here, i.e. the load that must be placed on the weighing platform in order to carry out the application. If the load on the platform is too light, the following will occur:

- Error code *INF 29* appears,
- The weighing platform is not initialized,
- The preset reference sample quantity is saved.

Setting: *APPLIC./APPLIC. 1/PERCENT/MIN.INIT* menu item 3.6.

The minimum load can be set in 10 steps from 1 to 1000 digits (see available parameters). The “digits” here refer to the scale intervals for the connected weighing platform. If the interval of the connected platform is 1 g, for example, and 1000 digits are required, you must place at least 1000 g (= 1000 intervals = 1000 digits) on the weighing platform for initialization.

Resolution The resolution indicates the accuracy used to determine the reference weight. The default setting is “display resolution.” The resolution is increased when “10-fold” or “100-fold” is selected. “10-fold” increases the resolution of the net value by one step (display resolution x 10), “100-fold” increases it two steps (display resolution x 100).

Setting: *APPLIC./APPLIC. 1/PERCENT/RESOLUT* menu item 3.9.

Decimal Places The number of decimal places displayed can range from none up to 3 places.
Setting: *APPLIC./APPLIC. 1/PERCENT/DEC.PLCS* menu item 3.10.

Parameter for saving weight values The weight on the platform is saved as a reference value as soon as the platform has stabilized. “Stability” is defined as the point at which the fluctuation of a measured value lies within a defined tolerance. The narrower the tolerance, the more stable the platform is at “stability”.
The “increased stability” setting has a lower tolerance so that the average piece weight saves is more accurate and the results more reproducible; however, the measurement time can take longer.
Setting: *APPLIC./APPLIC. 1/PERCENT/SAVE.WT.* menu item 3.11.

Weighing in percent with two weighing platforms You can use two weighing platforms simultaneously with the Weighing in Percent application. When using two platforms, you can choose from the following operating modes:

- Weighing in percent with two platforms of the same type
- Weighing in percent with one reference platform and one weighing platform

Weighing in percent with two platforms of the same type

Use this mode to measure different types of sample material with different weights. For example, measure the lighter-weight samples on one platform and the heavier samples on another. You can define one of the two scales as the reference scale. The reference scale is the first scale active when you switch on the device, regardless of the setting for automatic initialization of the Neutral Measurement application.

Weighing in percent with one reference platform and one weighing platform

In this operating mode, the reference platform is a high-resolution weighing platform with a relatively low maximum capacity. The other platform is used for weighing heavier samples, and has a high capacity with a relatively low resolution. This allows you to both determine the reference piece weight with high resolution; i.e., very precisely, and to measure large samples, without requiring an expensive high-resolution, high-capacity weighing platform.

The system can be configured to switch automatically to the reference platform for initialization (the measured value line shows *REF*). Following initialization, you can switch to the counting platform.

Example: 100% of a sample material should be weighed.
 Configuration: The “Weighing in Percent” application is selected, and printout has been set up.

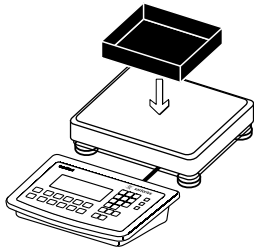

- ▶ Place empty container on the scale.



- ▶ Tare the scale.
 This is not required if the automatic tare function is active. The tare weight is saved automatically when you place the container on the platform.

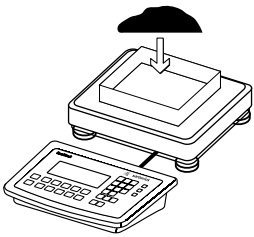
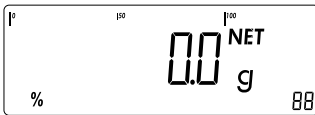

- ▶ Add reference material to the container in accordance with reference percentage value (in this example, 85 g).



- ▶ Start the calculation of the reference weight by pressing the **OK** key.
- ▶ The calculation is based on the active net weight value and the reference percentage value entered



If the weight is too light, an error code is shown in the main display *INF 29*.
 If this is the case, set the minimum load to a smaller number of digits.

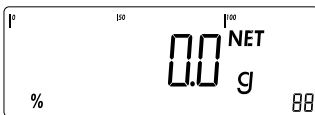

- ▶ Add additional material until the reference percentage value has been reached (in this example, 100 g)

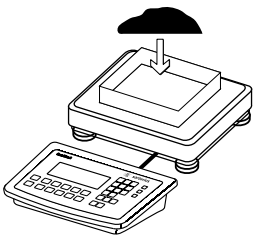

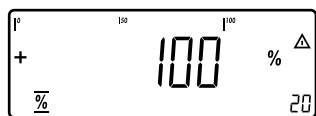

► Print the results.
Printout Configuration, see page 96

pRef + 20 %
wRef + 0.085 kg

G# + 1.080 kg
T + 0.675 kg
N + 0.423 kg

Prc + 100 %

Checkweighing \neq (Combics 2)

With this application, you can check whether the sample on the weighing platform matches a target value or lies within a given tolerance range. Checkweighing also makes it easy to fill sample materials to a specified target weight.

Selection and settings in the *APPLIC./APPLIC.2/CHECK.WG* menu.

- Features**
- Enter the nominal or target weight (set point) and the tolerance range delimiters either using the keypad or by saving the weight value of a load on the platform.
 - Enter the tolerance limits as absolute values (Min and Max), as a percentage deviation from the target or as a relative deviation from the target.
Setting: *APPLIC./APPLIC.2/CHECK.WG/CHECK.RG* menu item 4.5.
 - The target value can be taken over as a weighed value from a weighing platform, and the upper and lower tolerance limits are defined as a percentage deviation from the target value (setting 4.5.2). The following percentages can be selected as the deviation: 0.1%, 0.2%, 0.5%, 1%, 1.5%, 2%, 3%, 5% or 10%, selection using the **REF** key.
 - The target value, lower tolerance limit (minimum) and upper tolerance limit (maximum) can be applied as weighed values from the weighing platform (menu item 4.5.1).
 - The target value can be applied as weighed values and via asymmetrical percent limits (menu item 4.5.3).
 - The target value can be applied as weighed values and via relative weight limits (menu item 4.5.4).
 - Target and tolerance limits checked during input; values must conform to: upper limit > target > lower limit > 1 digit.
 - Checkweighing range: either 30% to 170% of the target, or from 10% to infinity.
 - Results are shown on the main display, as a bar graph and LED as well as sent to control output ports for further processing.
 - Toggle the main display between “weight value” and “relation to the target” by pressing the **↔** key. For the limit value, if the weight in the readout is outside the tolerance range, “LL” (too low) or “HH” (too high) is displayed
 - Activate Info mode via the **Info** key
 - Automatic results printout (*APPLIC./APPLIC.2/CHECK.WG/CHECK.RG* menu item 4.6).
 - Automatic taring of container weight (*APPLIC./AUT.TARE* menu item 3.7).
 - Automatic initialization when you switch on the scale with most recently saved application data (*APPLIC./AUT.START* menu item 3.8).

Combics 2 only: You can assign different functions to the **CF** key for deleting applications. When you clear applications, you can delete either the data stored for all applications or just selected data stored for the active application.

Setting: *APPLIC./CLER.CF* menu item 3.24

Tare function:

If you store a tare (weight value) by pressing the **↔T←** key, you can later enter a tare value manually. The tare value you enter is added to the stored tare value.

Setting: *APPLIC./TARE.FNC* menu item 3.25.1 (factory setting)

A tare value entered manually overwrites a stored tare value (weight value). If you enter a tare value manually, a tare value (weight value) stored later overwrites the manually entered value.

Setting: *APPLIC./TARE.FNC* menu item 3.25.2

Restore factory default settings: *APPLIC./RESET* menu item 9.1.

Target Checkweighing entails comparing the current weight value to a defined target. You can enter the value for this target using the keypad, or by saving the weight value indicated. You can also define upper and lower tolerance limits based on this target. You can do this by:

- Entering absolute values using the keypad or placing the desired amount of weight on the platform and saving the value
- or
- by entering each value as a percentage deviation of the target weight
- or
- by entering each value as an asymmetrical percentage deviation of the target weight that is selected via the keypad or using the **[REF]** key
- or
- by entering a relative weight deviation from the target weight via the keypad.

The value remains valid until deleted by pressing the **[CF]** key or until overwritten by a new value. It remains saved after the scale is switched off.





Preparation ► Open the *APPLIC./APPLIC.2/CHECK.WG* menu.

Available parameter settings

* = Factory setting

<i>MIN.INIT</i>	Minimum load for initialization	3.5
<i>1 DIGIT</i>	1 digit	3.5.1*
<i>2 DIGIT</i>	2 digits	3.5.2
<i>5 DIGIT</i>	5 digits	3.5.3
<i>10 DIGT.</i>	10 digits	3.5.4
<i>20 DIGT.</i>	20 digits	3.5.5
<i>50 DIGT.</i>	50 digits	3.5.6
<i>100 DIG.</i>	100 digits	3.5.7
<i>200 DIG.</i>	200 digits	3.5.8
<i>500 DIG.</i>	500 digits	3.5.9
<i>1000 DI.</i>	1000 digits	3.5.10
<i>AUT.START</i>	Automatic start of applications when you switch on the device with most recently saved application data	3.8
<i>AUTOMAT</i>	Automatic (on)	3.8.1*
<i>MANUAL</i>	Manual (off)	3.8.2
<i>TARE.FNC</i>	Tare function	3.25
<i>NORMAL</i>	Can add a preset tare if tare value is available; however no tare function possible	3.25.1*
<i>SPECIAL</i>	When a preset tare is entered, the tare value is deleted; however, tare function activation is possible	3.25.2
<i>CHECK.RG</i>	Checkweighing range	4.2.
<i>30-170%</i>	30 to 170%	4.2.1*
<i>10-MAX.L</i>	10% to infinity	4.2.2

<i>CTRL.SET</i>	Activate SET control output	4.3.
<i>OUTPUT</i>	SET output	4.3.1*
<i>OP.READY</i>	Ready to operate	4.3.2
<i>OUTP.ACT</i>	Activation of outputs	4.4.
<i>OFF</i>	Off	4.4.1
<i>ALWAY.ON</i>	Always on	4.4.2
<i>STABIL.</i>	At stability	4.4.3
<i>CHECK.RG</i>	Within checkweighing range	4.4.4*
<i>STAB.CHK</i>	On at stability within checkweighing range	4.4.5
<i>INPUT</i>	Parameter input	4.5.
<i>TAR.MN.MX</i>	Min, Max, target value	4.5.1*
<i>TARG.PER</i>	Only target value with percent limits	4.5.2
<i>TAR.A.PER</i>	Target value with asymmetrical percent limits	4.5.3
<i>TAR.TOL</i>	Target value with relative tolerances	4.5.4
<i>AUT.PRNT</i>	Automatic printing	4.6.
<i>OFF</i>	Off	4.6.1*
<i>ON</i>	On	4.6.2
<i>OK</i>	Only values within tolerance	4.6.3
<i>NOT OK</i>	Only values outside tolerance	4.6.4
<i>APP.ZERO</i>	Checkweighing toward zero	4.7.
<i>OFF</i>	Off	4.7.1*
<i>ON</i>	On	4.7.2

-  ► To save the setting, press the  key.
-   ... ► To exit setup: Press the  key several times.

Display The result of a measurement is shown either as a weight value or in relation to the target.

Weight display: The measured value line always shows the weight value, even if it lies outside the tolerance range. The bar graph is displayed with symbols indicating lower limit, target and upper limit. Weights are shown logarithmically up to the lower tolerance limit, and linearly beyond that point.

Relation to target value: As “Weight display” above, with the exception that:

- *LL* appears in the main display if the weight value is less than the lower limit
- *HH* is shown on the main display if the weight value is higher than the upper limit

Digital Input/Output Interface The **Checkweighing** application supports the digital input/output-interface. The four outputs are activated as follows:

- Lighter > red LED lights
- Equal > green LED lights
- Heavier > yellow LED lights
- Set

The outputs can also be galvanically isolated using option A5.

Acoustic signal: An acoustic signal can be activated in addition to the green LED. Setting: menu item 8.2.3

In the *APPLIC./APPLIC.2/CHECK.WG/OUTP.ACT* menu, menu item 4.4, you can make the following settings for the control outputs:

- switched off
- always on
- on at stability
- on within checkweighing range
- on at stability within checkweighing range

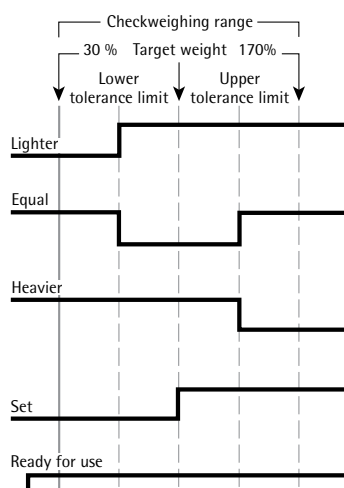

Digital Input/Output Interface

- "SET" control output: set or ready for use
- Activation of port lines: always on

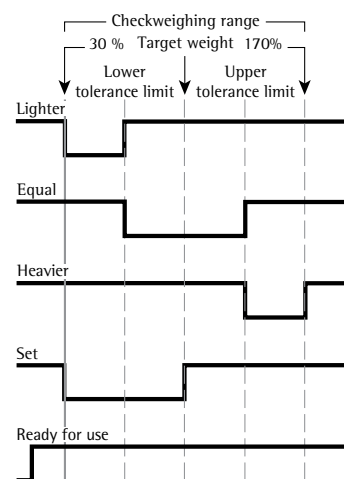

Digital Input/Output Interface

- "SET" control output: set or ready for use
- Activation of port lines: within checkweighing range

The "SET" output normally changes its voltage level when the load is near the target weight. Alternatively, you can assign the "Ready for use" function to this port.

Setting: *APPLIC./APPLIC.2/CHECK.WG/CTRL.SET* menu item 4.3.

This makes it possible, for example, to connect a simple indicator for weighing or calculation results.

All data output ports have a high voltage level when the application is not initialized

Output port specifications:

- When not in use, the voltage level is high: $>3.7\text{ V}/+4\text{ mA}$
- When activated, the voltage level is low: $<0.4\text{ V}/-4\text{ mA}$



The outputs are not protected against short circuits and are not galvanically isolated.

Example 1: Checkweighing samples with a target weight of 1250 g and a tolerance range from -10 g to +30 g. The tolerance values should be entered as absolute values (lower and upper tolerance limit).

Configuration: The “Checkweighing” application is selected using the setting *INPUT / TAR,MM,MX*, a printout has been set up (see “Configuration”).

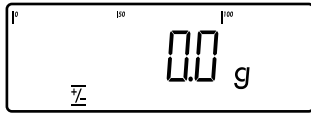

OK

▶ Start target value and tolerance entry using the **OK** key.



▶ The target value symbol flashes at the top of the display.

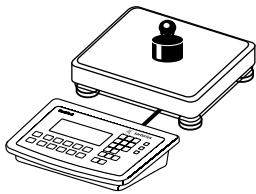

▶ Place a sample with the target weight (in this example, 1250 g) on the platform.



OK

▶ Save the target value.

▶ The minimum symbol flashes at the top of the display.



▶ Enter lower limit value (in this example, 1240 g).

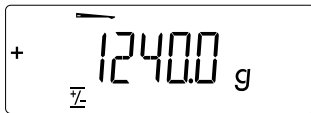

OK

▶ Save the lower limit value.

▶ The maximum symbol flashes at the top of the display.

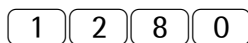

▶ Enter upper limit value (in this example, 1280 g).



OK

▶ Save the upper limit value.

▶ Because the sample with the target weight is still on the weighing platform, the weight is shown on the display with the checkweighing bars. The green LED indicates a value in the target range.

▶ Remove the sample with the target weight from the platform.

▶ The samples can now be placed on the platform and checked one after the other.

- ▷ The LEDs next to the display indicate the results:
 - yellow LED: sample too heavy
 - green LED: sample in tolerance range
 - red LED: sample too light



- ▶ Print the results.

Note: If automatic printout of results is enabled, you do not need to press the key. The results are printed automatically.

Printout configuration: see page 96

Setp	+	1.250 kg
Min	+	1.240 kg
Max	+	1.280 kg
G#	+	1.256 kg
T	+	0.000 kg
N	+	1.256 kg
Lim	+	0.48 %
W.Diff+		0.006 kg

Target
Minimum
Maximum

Gross weight
Tare weight
Net weight

Percentage of deviation from target*
Absolute deviation from target

* When displayed in relation to target value:

If the weight is lighter than the target, the display shows: LL

If the weight is heavier than the target, the display shows: HH

Example 2:

Checkweighing samples with a target weight of 1250 g and a tolerance range from -10 g to +30 g.

The tolerance values should be entered as a relative deviation from the target value. Configuration: The “Checkweighing” application is selected using the setting *INPUT / TAR.TOL*, a printout has been set up (see “Configuration”).

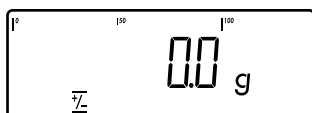

- ▶ Start target value and tolerance entry using the key.

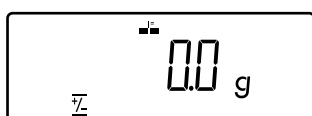

- ▷ The target value symbol flashes at the top of the display.

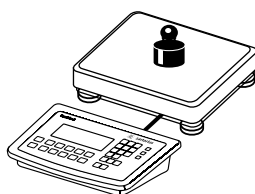

- ▶ Place a sample with the target weight (in this example, 1250 g) on the platform.

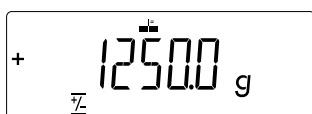

- ▶ Save the target value.

- ▷ The minimum symbol flashes at the top of the display.

1 0

▶ Enter the maximum lower deviation (in this example, 10 g).

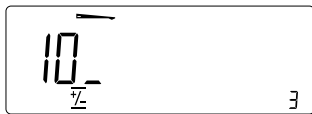

OK

▶ Save the lower limit value.

▷ The maximum symbol flashes at the top of the display.

3 0

▶ Enter the maximum upper deviation (in this example, 30 g).

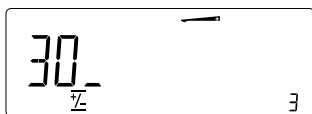

OK

▶ Save the upper limit value.

▶ Proceed as described in example 1.

Example 3: Checkweighing toward zero . Checkweighing samples with a target weight of 1250 g and a tolerance range from -10 g to +30 g. Configuration: The “Checkweighing toward zero” application (*APP.ZERO*) is selected as well as the *TAR.MIN.MX* entry, and a printout has been set up (see “Configuration”).



OK

▶ Start target value and tolerance entry using the **OK** key.

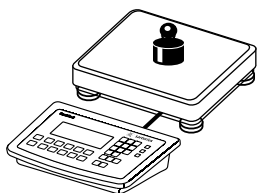

▶ Place a sample with the target weight (in this example, 1250 g) on the platform.

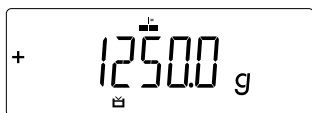

OK

▶ Save the target value.

1 2 4 0

▶ Enter lower limit value (in this example, 1240 g).

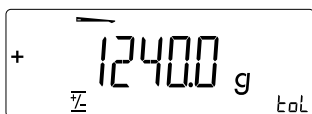

OK

▶ Save the lower limit value.

1 2 8 0

▶ Enter upper limit value (in this example, 1280 g).



OK ► Save the upper limit value.

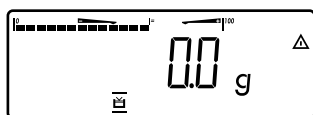

- Remove the sample with the target weight from the weighing platform.
- The samples can now be checked one after the other.
- ▷ The LEDs next to the display indicate the results:
 - yellow LED: sample too heavy
 - green LED: sample in tolerance range
 - red LED: sample too light



► Print the results.

Note: If automatic printout of results is enabled, you do not need to press the **F** key. The results are printed automatically.

Printout configuration: see page 96

Setp + 1.250 kg
 Min + 1.240 kg
 Max + 1.280 kg

Target
 Minimum
 Maximum

G# + 1.256 kg
 T + 0.000 kg
 N + 1.256 kg

Gross weight
 Tare weight
 Net weight

Lim + 0.48 %
 W.Diff+ 0.006 kg

Percentage of deviation from target*
 Absolute deviation from target

* When displayed in relation to target value:
 If the weight is lighter than the lower limit, the display shows: LL
 If the weight is heavier than the upper limit, the display shows: HH

Classification #1 (Combics 2)

With this application, you can determine whether the weight of a given sample lies within the limits of a defined weight class (*APPLIC.2* menu).

- Features**
- Classification with 3 or 5 weight classes.
Setting: *APPLIC./APPLIC.2/CLASS./PARAM.2/DTY.* menu item 4.8.
 - Enter the upper class limits using the keypad or by saving weight values from a load on the platform
 - Enter the upper limits of weight classes as absolute values or as a percentage of deviation from the upper limit of Class 1
Setting: *APPLIC./APPLIC.2/CLASS./PARAM.2/INPUT* menu item 4.9.
 - Activate Info mode via the **[Info]** key
 - Toggle the main display between classification display and weight display by pressing the **[↔]** key.
 - Automatic results printout
Setting: *APPLIC./APPLIC.2/CLASS./PARAM.2/PRINT* menu item 4.10.
 - Automatic taring of container weight.
Setting: *APPLIC./AUT.TARE*, menu item 3.7
 - Automatic initialization when the scale is switched on.
Setting: *APPLIC./AUT.START*, menu item 3.8

Exit application, delete parameters

The initialization values remain active until deleted using the **[CF]** key or overwritten or until the application is changed. The class limits also remain saved after the scale is turned off.

You can assign different functions to the **[CF]** key for deleting applications.

When you clear applications, you can delete either the data stored for all applications or just selected data stored for the active application.

Setting: *APPLIC./CLER.CF* menu item 3.24

Tare function:

If you store a tare (weight value) by pressing the **[T←]** key, you can later enter a tare value manually. The tare value you enter is added to the stored tare value.

Setting: *APPLIC./TARE.FNC* menu item 3.25.1 (factory setting)

A tare value entered manually overwrites a stored tare value (weight value). If you enter a tare value manually, a tare value (weight value) stored later overwrites the manually entered value.

Setting: *APPLIC./TARE.FNC* menu item 3.25.2

Restore factory default settings: *APPLIC./RESET* menu item 9.1.

- Limits**
- To use the Classification application, you need to enter the delimiters that separate one class from another. Limits between the individual weigh classes are required for the classification. The lower limit of Class 1 is defined by the preset minimum load. The other classes are configured by defining their upper limits. There are two ways to enter the delimiters for classes 1 through 3 (or 5):
- By saving **the weight value indicated**: Each upper limit value, with the exception of the highest class, is entered using the keypad or by saving the weight value of a load on the weighing platform.
- By entering **a percentage**: The upper value of Class 1 is entered using the keypad or by saving the value indicated. Upper limits for the other classes are defined by entering a percentage of deviation from the upper limit of Class 1, using the keypad.

Example: Enter 100 g as the upper limit of Class 1. Then enter 15%. When working with 3 classes, this yields the following weight classes:

Class 0: up to the minimum load

Class 1: > minimum load - 100 g

Class 2: > 100 g - 115 g

Class 3: > 115 g - maximum load

When working with 5 classes, this yields the following weight classes:

Class 0: up to the minimum load

Class 1: > minimum load - 100 g

Class 2: > 100 g - 115 g

Class 3: > 115 g - 130 g

Class 4: > 130 g - 145 g

Class 5: > 145 g - maximum load

The values entered remain valid until deleted by pressing the **CF** key or until overwritten by a new value. They remain saved after the scale is switch-off.

Preparation ► Open the *APPLIC. / APPLIC.2 / CLASS.* menu.

Available parameter settings

* = Factory setting

<i>MIN.INIT</i>	Minimum load for initialization	3.6
<i>1 DIGIT</i>	1 digit	3.6.1*
<i>2 DIGIT</i>	2 digits	3.6.2
<i>5 DIGIT</i>	5 digits	3.6.3
<i>10 DIGIT.</i>	10 digits	3.6.4
<i>20 DIGIT.</i>	20 digits	3.6.5
<i>50 DIGIT.</i>	50 digits	3.6.6
<i>100 DIG.</i>	100 digits	3.6.7
<i>200 DIG.</i>	200 digits	3.6.8
<i>500 DIG.</i>	500 digits	3.6.9
<i>1000 DI.</i>	1000 digits	3.6.10
<i>CTRL.SET</i>	Activate SET control output	4.3.
<i>OUTPUT</i>	SET output	4.3.1*
<i>OP.READY</i>	Ready to operate	4.3.2
<i>OUTP.ACT</i>	Activation of outputs	4.7
<i>OFF</i>	Off	4.7.1*
<i>ALWAY.ON</i>	Always on	4.7.2
<i>STABIL.</i>	On at stability	4.7.3
<i>QTY.</i>	Number of classes	4.8.
<i>3 CLASS</i>	3 classes	4.8.1*
<i>5 CLASS</i>	5 classes	4.8.2
<i>INPUT</i>	Parameter input	4.9.
<i>WEIGHTS</i>	Weight values	4.9.1*
<i>PERC.TAG</i>	Percentage values	4.9.2
<i>PRINT</i>	Automatic Printing	4.10.
<i>MANUAL</i>	Off	4.10.1*
<i>AUTOMAT</i>	On	4.10.2



► To save the setting, press the **T** key.



...

► To exit setup: Press the **0** key several times.

Minimum load for initialization You can set the minimum load here, i.e. the load that must be placed on the weighing platform in order to carry out the application. If the load on platform is too light, then this is class 0.

Setting: *APPLIC./APPLIC. 1/EQUNT./MIN.INIT* menu item 3.6.

The minimum load can be set in 10 steps from 1 to 1000 digits (see available parameters). The “digits” here refer to the scale intervals for the connected weighing platform. If the interval of the connected platform is 1 g, for example, and 1000 digits are required, you must place at least 1000 g (= 1000 intervals = 1000 digits) on the weighing platform for initialization.

Display The result of a given measurement is shown as either a weight value or a class number.

Weight display: The current weight is shown in the measured value line and the current class in the number display.

Display of classes: The current class is displayed in the measured value line.

Digital Input/Output Interface The Classification application supports the digital input/output-interface. The four outputs are activated as follows:

With 3 classes:

- Class 1 0 red LED (output <)
- Class 2 0 green LED (output =)
- Class 3 0 yellow LED (output >)
- Set -

With 5 classes:

- Class 1/2 (output <)
- Class 2/3/4 (output =)
- Class 4/5 (output >)
- Set -

The switched outputs can also be galvanically isolated using option A5.

Acoustic signal: An acoustic signal can be activated in addition to the green LED.

Setting: menu item 8.2.3

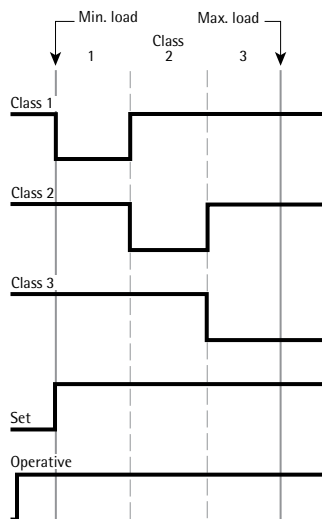

Digital Input/Output Interface
Control lines when working with 3 classes

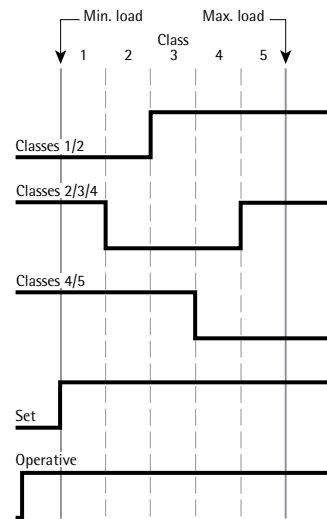

Digital Input/Output Interface
Control lines when working with 5 classes

In the *APPLIC./APPLIC.3/CLASS./PARAM.2/OUTP.ACT* menu, menu item 4.7, you can make the following settings for the control outputs:

- switched off
- always on
- on at stability

The “SET” output normally changes its voltage level when the current weight exceeds the minimum load. Alternatively, you can assign the “Ready for use” function to this port.

Setting: *APPLIC./APPLIC.3/CLASS./PARAM.2/CTRL.SET* menu item 4.3.

Example 2: There should be three classes.
 Configuration: The “Classification” application is selected, and printout has been set up.

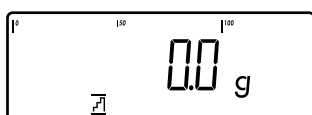

► Enter the class limits using the key.

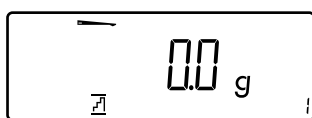

► Enter the upper limit for Class 1 using the keypad (in this example, 110 g)

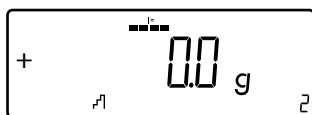

► Save the upper limit for Class 1.

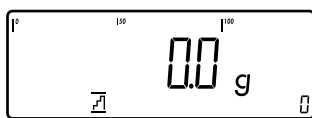

► Enter the upper limit for Class 1 using the keypad (in this example, 110 g).

► Save the upper limit for Class 1.

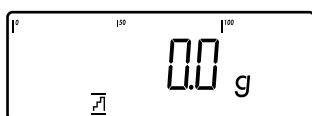

► Place the sample on the weighing platform.

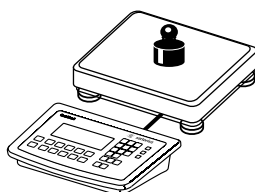

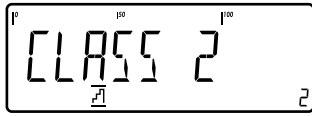

▷ The result is displayed.



▶ Print the results.

Note: If automatic printout of results is enabled, you do not need to press the  key. The results are printed automatically.

Printout Configuration, see page 96

Lim1 + 0.110 kg
 Lim2 + 0.130 kg

G# + 0.118 kg
 T + 0.000 kg
 N + 0.118 g

Class 2

Totalizing Σ (Combics 2)

With this application, you can add weights to the totalizing memory. In addition to weight values, the number of separate values added to memory is also saved (*APPLIC.3* menu).

- Features**
- You can weigh up to 999 items.
 - Save values automatically: Simultaneous saving of net values and calculated values (if available).
Setting: *APPLIC./APPLIC.3/TOTALIZ* menu item 3.16.
 - Save weight values and calculated values from either Application 1 (for example, Counting, Weighing in Percent) or Application 2 (Checkweighing).
Setting: *APPLIC./APPLIC.3/TOTALIZ* menu item 3.22.
 - Current transaction number displayed in the number display (indicating the transactions already added)
 - Weighing in up to a defined target, with the totalization memory content + current weight displayed in the text lines
 - Save weight values manually or automatically
 - Accurate calculation of total of weight values from two weighing platforms
 - Activate Info mode via the **Info** key
 - Automatic printout when value saved
 - Automatic taring of container weight.
Setting: *APPLIC./AUT.TARE*, menu item 3.7

Exit application, delete parameters

The value of the totalizing memory remains valid until deleted by pressing the **CF** key.

You can assign different functions to the **CF** key for deleting applications. When you clear applications, you can delete either the data stored for all applications or just selected data stored for the active application.
Setting: *APPLIC./CLER.CF* menu item 3.24

Tare function:

If you store a tare (weight value) by pressing the **T+** key, you can later enter a tare value manually. The tare value you enter is added to the stored tare value.
Setting: *APPLIC./TARE.FNC* menu item 3.25.1 (factory setting)

A tare value entered manually overwrites a stored tare value (weight value). If you enter a tare value manually, a tare value (weight value) stored later overwrites the manually entered value.

Setting: *APPLIC./TARE.FNC* menu item 3.25.2

Restore factory default settings: *APPLIC./RESET* menu item 9.1.

The Combics has a totalizing memory for adding individual net and gross values. You can save weight values in totalizing memory manually or automatically.
Setting: *APPLIC./APPLIC.3/TOTALIZ* menu item 3.16.

- **Save value manually** by pressing the **OK** key.
The value taken from the active platform is added to the value already saved in totalization memory and the transaction counter value is increased by one. When a value is added manually, the program does not check whether the platform has been unloaded since the last time the **OK** key was pressed.

- **Value saved automatically** when the weighing platform is stable and the defined minimum load is exceeded.
If the defined minimum load is not exceeded, you can save the item manually by pressing the **[OK]** key. Regardless of these settings, the current value cannot be saved automatically unless the platform is unloaded before the next sample is placed on it. The weighing platform is considered to be unloaded when the load is less than 50% of the minimum load.

The number of items added to memory is shown in the number display. Press the **[CF]** key to clear the totalizing memory. A printout is automatically generated.

With two weighing platforms connected, you can add values from both platforms to the totalizing memory. The displayed result is accurately calculated in the active weight unit.

Example: When you add 1.243 g (determined on a weighing platform with three decimal places) to 1.4 g (determined on a platform with 1 decimal place), the display shows 2.643 kg.

Preparation ► Open the *APPLIC./APPLIC.3/TOTALIZ* menu.

Available parameter settings

* = Factory setting

<i>MIN.INIT</i>	Minimum load for initialization	3.6
<i>1 DIGIT</i>	1 digit	3.6.1*
<i>2 DIGIT</i>	2 digits	3.6.2
<i>5 DIGIT</i>	5 digits	3.6.3
<i>10 DIGT.</i>	10 digits	3.6.4
<i>20 DIGT.</i>	20 digits	3.6.5
<i>50 DIGT.</i>	50 digits	3.6.6
<i>100 DIG.</i>	100 digits	3.6.7
<i>200 DIG.</i>	200 digits	3.6.8
<i>500 DIG.</i>	500 digits	3.6.9
<i>1000 DI.</i>	1000 digits	3.6.10
<i>AUTO.SAV</i>	Autosave	3.16.
<i>OFF</i>	Off	3.16.1*
<i>ON</i>	On	3.16.2
<i>PRT.SAV.</i>	Individual/Component printout when saved	3.17.
<i>OFF</i>	Automatic printing off	3.17.1
<i>ON</i>	Print the entire standard print configuration every time with the [OK] key is pressed	3.17.2*
<i>VAL.FROM</i>	Source of data for autosave	3.22.
<i>APPLIC.1</i>	Application 1	3.22.1*
<i>APPLIC.2</i>	Application 2	3.22.2
<i>SAV.VAL.</i>	Save value	3.23.
<i>NET</i>	Net	3.23.1*
<i>CALCUL.</i>	Calculation	3.23.2
<i>NET+CAL</i>	Net and Calculated	3.23.3

Printout You can configure whether a printout is generated automatically when a weight value is stored in the totalizing memory or manually by pressing the **[E]** key. Setting: *APPLIC./APPLIC.3/TOTALIZ* menu item 3.17.

- You can print manually by pressing the **[E]** key (single printout): 3.17.1
- Component log (single printout of an item): 3.17.2

The total data record is printed when you clear the totalizing memory (by pressing the **[CF]** key).

Example: Totalizing weight values.
 Configuration: The “Totalizing” application is selected, and printout has been set up. Setting: *SETUP / PRINT / PROTOCOL*. menu item 7.6
 Component log: menu item 7.7.
 Total data record: Menu item 7.8

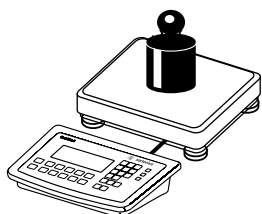

▶ Place the first weight on the weighing platform.

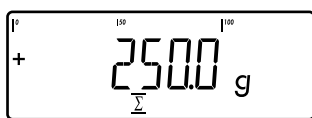

▷ The weight value is displayed.

OK

▶ Store first weight value in totalizing memory.

G#	+	0.250 kg
T	+	0.000 kg
N	+	0.250 kg
n		1

▷ Item is printed automatically (**component log**).

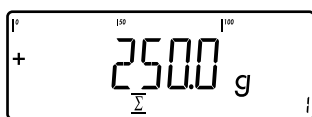

▷ The transaction counter value is increased by one (to 1).

▶ Remove the first weight from the weighing platform and place the second weight.

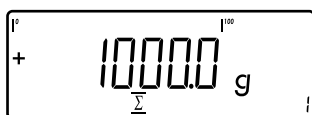
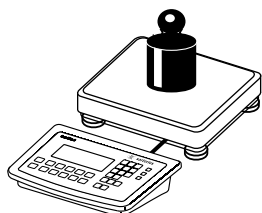

▷ The weight value is displayed.

OK

▶ Store second weight value in totalizing memory.

G#	+	1.346 kg
T	+	0.346 kg
N	+	1.000 kg
n		2

▷ Item is printed automatically (**component log**).

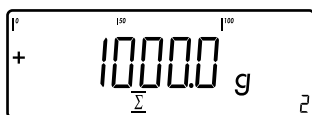

▷ The transaction counter value is increased by one (to 2).



▶ Toggle the display between **individual value** and **total**.





▶ End totalizing.

G# + 1.346 kg
 T + 0.346 kg
 N + 1.000 kg
 n 2

▶ Configured **total data record** is printed.

Net Total Formulation (Combies 2)

With this application, you can weigh in different components up to a defined total. Each component is saved in the net-total memory (*APPLIC.3* menu).



- Features**
- Weigh in up to 999 components in series
 - Net total formulation **cannot** be combined with level 1 and 2 applications (*APPLIC.1*, *APPLIC.2*).
 - Current component number displayed in the number line (indicating the component to be added)
 - Toggle the display from “component mode” to “additive mode” by pressing the  key
 - **Component mode:** Display the weight of the component currently on the platform (for 1 second after it is saved; then the platform is tared)
 - **Additive mode:** Display the weight of all components on the platform (after it is saved, the net weight of the last component added is displayed briefly)
 - Toggle to a second weighing platform while weighing in
 - Activate Info mode via the  key
 - Automatic component printout when it is saved.
Setting: *APPLIC./APPLIC.3/NET TOT* menu item 3.17.

Printout If the 3.17.2 menu item is selected, the entire component record is printed. If the 3.17.3 menu item is selected, the following items are generated only once for the first component if they have been configured:
Blank line, dash line, date, time, ID1 through ID6, header lines 1 and 2. For subsequent components, each “component” item (“Comp xx”) is followed by a blank line.

- Automatic taring of container weight.
Setting: *APPLIC./AUT.TARE* menu item 3.7
- Restore factory default settings
Setting: *APPLIC./RESET* menu item 9.1

Preparation ► Open the *APPLIC./APPLIC.3/NET TOT* menu.

Available parameter settings

* = Factory setting		
<i>MIN.INIT</i>	Minimum load for initialization	3.6
	<i>1 DIGIT</i> 1 digit	3.6.1*
	<i>2 DIGIT</i> 2 digits	3.6.2
	<i>5 DIGIT</i> 5 digits	3.6.3
	<i>10 DIGT.</i> 10 digits	3.6.4
	<i>20 DIGT.</i> 20 digits	3.6.5
	<i>50 DIGT.</i> 50 digits	3.6.6
	<i>100 DIG.</i> 100 digits	3.6.7
	<i>200 DIG.</i> 200 digits	3.6.8
	<i>500 DIG.</i> 500 digits	3.6.9
	<i>1000 DI.</i> 1000 digits	3.6.10
<i>PRT.SAV.</i>	Individual/Component printout when saved	3.17.
	<i>OFF</i> Automatic printing off	3.17.1
	<i>EACH.TIM.</i> Print the entire standard print configuration every time the  key is pressed	3.17.2*
	<i>ONCE</i> Print the entire standard print configuration once with the  key	3.17.3

Minimum load The minimum amount that a component must weigh before it can be saved in net-total memory.

Setting: *APPLIC./APPLIC.3/NET TOT* menu item 3.6

Once the limit is exceeded by the load, the value can be saved. If the load on platform is too light, the following will occur when you try to save a value:

- The error code *INF 29* is displayed
- A warning signal is emitted (double-beep)
- The weight value is not saved

The minimum load required for automatic taring of the container weight on the platform (first weight) is configured under: *APPLIC./MIN.TARE* menu item 3.5

The minimum load can be set in 10 steps from 1 to 1000 digits (see available parameters). The “digits” here refer to the scale intervals for the connected weighing platform. If the interval of the connected platform is 1 g, for example, and 1000 digits are required, you must place at least 1000 g (= 1000 intervals = 1000 digits) on the weighing platform for autotaring (only with the “Autotare first weight” option selected).

Net total formulation with two weighing platforms

This mode is used for weighing large and small components at the same time. This makes it possible to toggle from the small-component platform to the large-component platform during measurement. Once you toggle to the large-component platform, the $\leftarrow 0 \rightarrow$ and $\leftarrow T \rightarrow$ keys are available until a component is value is saved. For example, you can tare a partially-filled container taken from the small-component platform on the large component platform.

The value in component memory on the small-component platform is transferred to the large-component platform and the weight unit is converted, if necessary. The Component and Additive display modes are both available on the large-component platform.

The value read by the active platform is saved in component memory. The displayed result is accurately calculated in the active weight unit.

When you press $\leftarrow CF \rightarrow$ to stop a measurement series the tare memories for both platforms are cleared, unless the large-component platform is an SBI instrument, in which case the platform is only tared.

Example: Three components of a formula should be weighed. Configuration: The “Net total formulation” application is selected, and printout has been set up.

Setting: *APPLIC./APPLIC.3/NET TOT*

Component log: *SETUP / PRINT / PROTOC.* menu item 7.7

Total data record: *SETUP / PRINT / PROTOC.* menu item 7.8

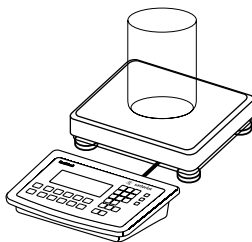

- Place empty container on the scale.



- ▶ Tare the scale.
This is not required if the automatic tare function is active. The tare weight is saved automatically when you place the container on the platform.

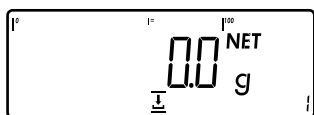

- ▶ The prompt to fill and save the first component is shown.

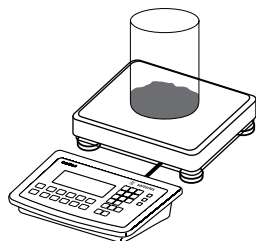

- ▶ Place the first component into the container (in this example, 1100 g).

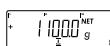

- ▶ The weight of the first component is displayed.



- ▶ Save the weight of the first component using the **OK** key.

Cmp001+ 1.100 kg

- ▶The component record is printed automatically.

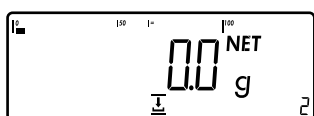

- ▶ The weighing platform is tared and the component counter value is increased by one. The prompt to fill and save the second component is now displayed.

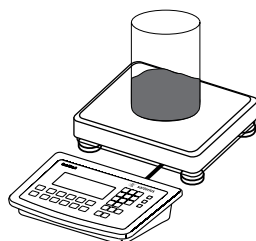

- ▶ Place the second component into the container (in this example, 525 g).



- ▶ The weight of the second component is displayed.



- ▶ Save the weight of the second component using the **OK** key.

Cmp002+ 0.525 kg

- ▶The component record is printed automatically.

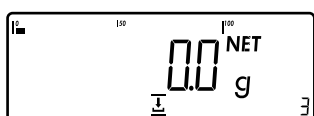

- ▶ The weighing platform is tared and the component counter value is increased by one. The prompt to fill and save the third component is now displayed.



- ▶ Toggle to the “additive mode” using the **↻** key to display the total weight of all components.

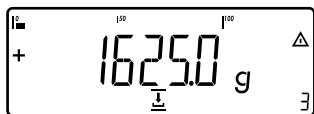

▶ The value displayed equals the weight of components added up to now plus the current weight on the platform.

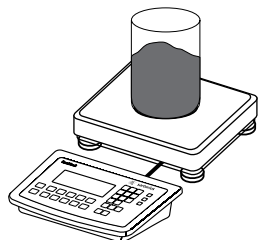

▶ Place the third component into the container until the desired total weight is reached (in this example, 2000 g).

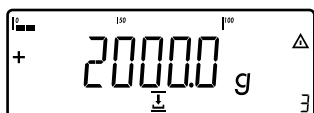

▶ The total weight is displayed.



▶ Save the weight of the third component using the **OK** key.

Cmp003+ 0.375 kg

▶ The component record is printed automatically.

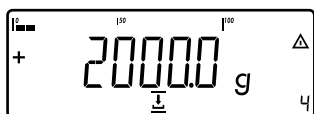

▶ The component counter value is increased by one. The prompt to fill and save the fourth component is now displayed.



▶ End component weighing by pressing the **CF** key.

```
n      +      3
Tot. cp+  2.000 kg
Cont. T+  0.296 kg
```

▶ Results are printed automatically (configured total data record).

Number of components

Content of component memory

Content of tare memory (container weight)

Combining Application Programs

The following table shows how the applications described can be combined. The basic **weighing** function is available at all times; it does not need to be combined with a computational function.

Select programs one after the other: Toggle using the  key

Application 1 (Basic Function)	Application 2 (Monitoring Function)	Application 3 (Cumulative-value Function)
Counting	–	Totalizing
Counting	Checkweighing	Totalizing
Counting	Checkweighing	–
Counting	Classification	–
Neutral Measurement	–	Totalizing
Neutral Measurement	Checkweighing	Totalizing
Neutral Measurement	Checkweighing	–
Neutral Measurement	Classification	–
Animal Weighing	–	Totalizing
Animal Weighing	Checkweighing	Totalizing
Animal Weighing	Checkweighing	–
Animal Weighing	Classification	–
Weighing in Percent	–	Totalizing
Weighing in Percent	Checkweighing	Totalizing
Weighing in Percent	Checkweighing	–
Weighing in Percent	Classification	–
–	–	Net-total Formulation
–	Checkweighing	Totalizing

Example: “Portioning” (counting , checkweighing  with totalizing )

Configuration:

Application 1: Counting (*ECOUNT*.)

Application 2: Checkweighing (*CHECK*.)

Application 3: Totalizing (*TOTALIZ*): Saved value: Net + Calculated (3.23.3)

Autosave: On (3.16.2)

Source of data: Application 2 (3.22.2)

Setup: Printout: *PRT PROT 7.8*. Printer 1: “Total printout: Print when FN pressed,” then select the menu line items of your choice.

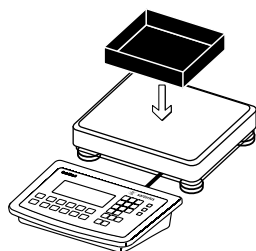

- ▶ Place empty container on the scale.

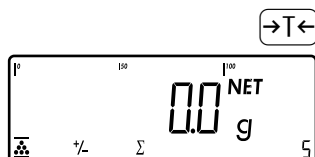

- ▶ Tare the scale.
This is not required if the automatic tare function is active. The tare weight is saved automatically when you place the container on the platform.

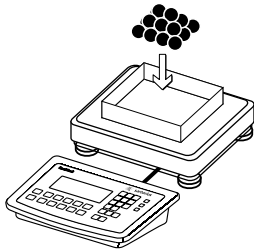

- ▶ Place a number of parts in the container for the reference quantity (in this example, 10 pcs).

OK

- ▶ Start the calculation of the reference piece weight.



- ▶ If the weight is too light, an error code is shown in the main display *INF 29*. Reduce the minimum load setting or increase the reference sample quantity setting and the number of parts in the container.



- ▶ Toggle to Checkweighing.

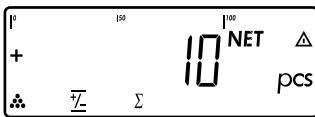

OK

- ▶ Start Checkweighing.

1 0 0

- ▶ Enter target value, minimum and maximum (in this example, target 100 pieces, minimum 100 pieces, maximum 102 pieces).

OK

1 0 0

OK

1 0 2

OK



- ▶ Toggle to totalizing.

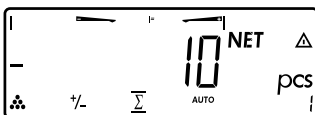

- ▶ Add desired number of pieces.

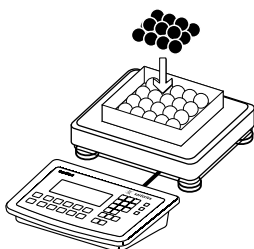

▶ The number of pieces is saved automatically.

▶ Unload the scale: Remove the samples

▶ Perform further counting operations as desired.

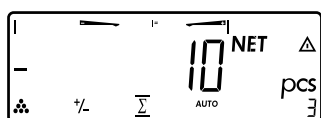
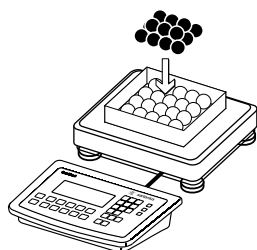

▶ Toggle display from individual value to total.



▶ End the portioning options and print the final evaluation.

```

-----
nRef +      10 pcs
wRef + 0.001000 kg
Setp +      100 pcs
Min  +      100 pcs
Max  +      102 pcs

n      6
*N    +      0.600 kg
Total +      600 pcs
-----
    
```

Configured printout: Total

Configuring printouts

Purpose You can individually define each measurement printout. This should be carried out **after** setting the applications since some data in the printout is application-dependent.

In the “Print parameters” menu, single, component and total data records can be configured, which contain the available print items for the respective applications. Using the total data record for “Totalizing” and “Net-total Formulation” applications, you can define which parameters are printed using the **CF** key.

- Features**
- Six lists each with a max. length of 30 print items
 - Single printout Printer 1
 - Component printout Printer 1
 - Total data printout Printer 1
 - Single printout Printer 2
 - Component printout Printer 2
 - Total data printout Printer 2
 - Single, component and total data records can be configured separately
 - Print single printout: **EF** key
 - Auto printout of application when Setup menu is activated:
 - Animal weighing (averaging)
 - Checkweighing
 - Classification
 - Print component printout (Combics 2 only):
 - Totalizing/Net-total formulation with the **OK** key
 - Setting: *APPLIC./APPLIC.3/TOTALIZ* printout: component printout
 - Print totalizing printout (Combics 2 only):
 - For selected application Totalizing/Net-total formulation with **CF** key
 - When switching to another application in Setup, only the application-dependent printout lists are deleted. The other printout lists remain saved.
 - Print items can be deleted individually: Press and hold the **⇨0⇩** key
 - Print items “Form Feed” for record footer:
 - Move to the next label start for printer type: YDP14IS: “Label” and YDP04IS, setting “Label, manual form feed”
 - ISO/GLP/GMP-compliant printout: The Setup menu configuration under “ISO/GMP-compliant printout” is also active for configured printouts.

- Preparation
- ▶ Open Menu mode (see page 31).
 - ▶ Select the *SETUP* menu.
 - ▶ Select and open the *PRINT* submenu.
 - ▶ Select and open the *PROTOC.* submenu.

Available parameter settings

<i>PROTOC.</i> Protocol	7	
<i>HEADLIN.</i>	Header and ID header input	7.4
<i>QTY.1</i>	Quantity interface 1	7.5
<i>INDIV.1</i>	Standard interface 1	7.6
<i>COMPON.1</i>	Component interface 1	7.7
<i>TOTAL.1</i>	Result interface 1	7.8
<i>QTY.2</i>	Quantity interface 2	7.9
<i>INDIV.2</i>	Standard interface 2	7.10
<i>COMPON.2</i>	Component interface 2	7.11
<i>TOTAL.2</i>	Result interface 2	7.12
<i>GMP.PROT</i>	ISO/GMP	7.13

	<i>DAT/TIM</i>	Date without time	7.14
	<i>AUT.ONCE</i>	Automatic printout after stability	7.15
	<i>FLEX.PRIN</i>	Flex print	7.16
	<i>DEC.SEP.</i>	Decimal separator	7.17
	<i>ALIB.MEM</i>	Alibi memory	7.18
<i>RESET</i>		Restore factory default settings	9
		Setting factory settings	9.1

- The rows of the protocol list can be called up and activated individually.
Example: see under Configuration, menu item 7.6
- The print selection set as active appears with the left selection bar on the display, e.g. gross, tare, net.
 - ▶ Expand the printout: Press the **→T←** key. The selection bar appears on the right of the display.
 - ▶ Select print items: Press the **Fn** key
 - ▶ Save the desired print items: Press the **→T←** key
 - ▶ Press the **→0←** key: to switch to the active print selection. The selection bar appears on the left. The required print item is set as active and appears in the printout.
- Print items can be deleted individually from the active printout selection:
Press and hold the **→0←** key.
 - ▶ Save settings with the **→T←** key and exit Setup: Press the **→0←** key several times.

Additional Functions

Printing the "Selection" and "List" Settings

LIST: Output of the current printout list

SELECT: Print currently selectable items

- ▶ When the selection bar is in LIST or SELECT: Press the **⏏** key.

Printout (example)









```

Indiv. Prt
List
=====
Net (N)
Gross (G#)
Tare
Tare (T2/PT2)
Piece count
=====
etc.
    
```

Example: Standard printout for data output from the “Counting” application

Configuration:



- Application: Application 1: Counting
- Then access Setup: Printout: Printer 1: “Individual: print by pressing (E)”

-   ... ▶ Select the *SETUP* menu.
-   ...  ▶ Select and open the *PRINT* submenu.
-   ...  ▶ Select and open the *PROTDC.* submenu.



-   ... ▶ Press the  key until 7.4 appears in the display



-   ... ▶ Press the  key until 7.6 appears in the display

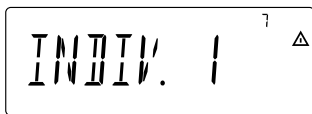

-  ▶ Press the  key.

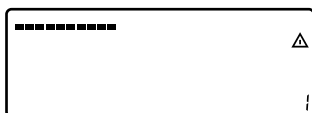



- ▷ The list of print items appears.



-  ▶ Press the  key to go to the selection list.





- ▷ The first print item of the selection list is displayed.

-  ▶ Press the  key to scroll through the available print items in the selection list.
or

-  ▶ Press the  key to add the displayed print item from the selection list to the list of print items.

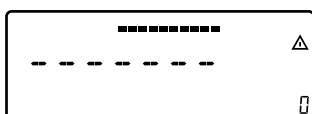
-   ... ▶ Press the  key until the line row appears in the display.



-  ▶ Press the  key to save the selection.

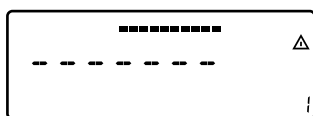

▶ The counter value is increased by one.



▶ Press the **Fn** key until the “Reference weight” entry appears in the display.

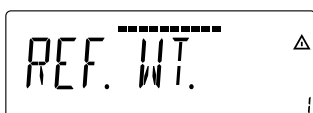

▶ Press the **→T←** key to save the selection.

▶ You can now select additional print items in the same way.

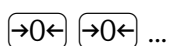

▶ To exit print item entry, press the **→0←** key until *APPLIC.* appears in the display.



▶ Press and hold the **→T←** key (2–3 sec) to switch to weighing mode.

▶ Carry out weighing.



▶ Press the **→E←** key to print the results.

----- Printout example

```
nRef  +      5 pcs
wRef  +      8 pcs
wRef  +  0.4000 g
```

Product Data Memory (Combics 2)

Purpose The product data memory stores initialization data and user data (product and tare values).

- Features**
- The product data memory has 100 memory cells for product or tare values. For example, you can store 80 sets of application data and 20 tare values
 - Each memory cell is uniquely identified by a number of up to three digits.
 - The product data memory can be used with the following applications:

Application 1	Application 2
- Basic Weighing	- Checkweighing
- Counting	- Classification
- Neutral Measurement	
- Animal Weighing	
- Weighing in Percent	
 - Data records can be created, overwritten and individually deleted
 - Data remains stored when the scale is switched off

Saving product data (in this example in the “Counting” application)

Start the Counting application.

- ▶ Enter a memory number and press and hold the **Mem** key (min 2 seconds).

Saving preset tare values

- ▶ Allocate preset tare memory.
- ▶ Enter a memory number and press and hold the **Tare** key (min 2 seconds).

Activating saved product or tare values

- ▶ Enter a memory number and press the **Mem** key.

Displaying information for a specific product or tare value

- ▶ Enter a memory number and press the **Info** key.
- Use the **Fn** key to switch between wRef (average piece weight) and nRef (quantity).
- Use the **→T←** key to scroll the displayed value to the right.
- Use the **Mem** key to activate the displayed memory.
- Press and hold the **CF** key (min. 2 seconds) to delete the displayed memory.
- ▶ Exit the mode using the **CF** key.

Displaying information for all product or tare memories

- ▶ Press the **Mem** key to display the first memory number.
- Press the **Fn** key to scroll through in lexical order (e.g. 1, 3, 333, 4, etc.).
- Use the **Mem** key to activate the selected memory number.
- Press the **Info** key to display the saved product values.
- Press and hold the **CF** key (min. 2 seconds) to delete the selected memory number.
- ▶ Exit the mode using the **CF** key.

Deleting specific memory numbers

- ▶ Enter a memory number and press and hold the **CF** key.

Example: Using the Counting application with a stored average piece weight.
Configuration: Application: Counting (COUNT.)

Saving the average piece weight

Start the application.

- ▶ Determine the average piece weight using one of the methods described above.
- ▶ Enter the memory cell number using the keypad, and press and hold the **Mem** key (min 2 seconds).

Loading the average piece weight or reference sample quantity

- ▶ Enter the memory cell number and press the **Info** key.
- Use the **Fn** key to switch between wRef (average piece weight) and nRef (quantity).
- Use the **→|←** key to scroll the displayed value to the right.
- Use the **Mem** key to activate the displayed memory.
- Press and hold the **CF** key (min. 2 seconds) to delete the displayed memory.
- ▶ Exit the mode using the **CF** key.

Overwriting data in a memory cell

- ▶ Enter the memory cell number to be overwritten via the keypad.
- ▶ Press and hold the **Mem** key (min 2 seconds).
- ▷ The previous average piece weight is overwritten.

- ▶ To cancel without saving, press the **CF** key.

Deleting an average piece weight

- ▶ Enter the memory cell number of the average piece weight to be overwritten.
- ▶ Press the **Info** key.
- ▶ Delete the displayed value by pressing and holding the **CF** key (min. 2 seconds).

Data Interfaces

The indicator is equipped with the following data interfaces:

- **COM1**: Standard data interface (RS-232)
- **UniCOM**: Universal data interface (optional)

Both interfaces can be configured in the *SETUP* menu for different input and output functions (e.g. printer, 2nd weighing platform, PC, checkweighing). The optional UniCOM interface can be used as an RS-232, RS-485/RS-422, analog output (voltage/current interface), galvanically separated digital I/Os, Profibus or Ethernet. A barcode scanner can be connected (Combics 2 only) via the PS/2 socket or the corresponding screw terminals (IP69K).

- Features**
- CAISL1 and CAISL2 indicators (IP44 protection):
Connect via a 25-pin D-Sub female connector.
 - CAIS1 and CAIS2 indicator (IP69K protection):
Route the connecting cable from the peripheral device to the indicator via a cable gland. The free cable ends are connected via the screw terminals.



Warning when using third-party RS-232 connecting cables: The pin assignments may not be compatible with Sartorius equipment. Check the pin assignment against the cabling diagrams and disconnect any lines that are not assigned. Failure to do so may cause malfunction, damage or even completely ruin your indicator and/or peripheral device(s).

Specifications

Serial interface:	Interface operating mode: Full duplex
	Level: COM1: RS-232, UniCOM ¹⁾ : RS-232 or RS-422
	Connection: CAISL1, CAISL2 devices (IP44 protection): 25-pin D-Sub socket CAIS1, CAIS2 devices (IP69K protection): Connection via screw terminals in the housing, cable routed into the housing via a cable gland.
	Transmission rate: 150, 300, 600, 1200, 2400, 4800, 9600, 19,200 baud (depending on the operating mode)
	Number of data bits: 7, 8 bits
	Parity: Space, odd, even, none (depending on the operating mode)
	Number of stop bits: 1 or 2
	Handshake mode: Software (XON/XOFF), hardware (1 character after CTS)
	Protocols: SBI, XBPI-232 ²⁾ , XBPI-485 ¹⁾²⁾ , MP8-binary ³⁾ , SMA various printers: – YDP20-OCE – Universal – YDP14IS – YDP04IS – YDP14IS-Label – YDP04IS-Label
	Network address ⁴⁾ : 0, 1, 2, ..., 31
	SBI: Manual data output: Without stability, after stability, configurable printout
	SBI: Auto data output: Without stability, at stability, at user-defined intervals
	SBI: Output format: 16 or 22 characters
	Printout of application data: Output of a configurable printout

Analog UniCOM interface (optional)

Level:	4 to 20 mA, 0 to 20 mA, 0 to 24 mA, 0 to 10V
Power supply:	Internal
Factory setting:	4 to 20 mA
Connection:	CAISL1, CAISL2 devices (IP44 protection): 25-pin D-Sub socket CAIS1, CAIS2 devices (IP69K protection): Connection via screw terminals in the housing, cable routed into the housing via a cable gland.

¹⁾ Optional UniCOM universal data interface

²⁾ XBPI operating mode: 9600 baud, 8 data bits, parity: odd, 1 stop bit

³⁾ Only with the standard COM1 interface

⁴⁾ Network address is valid only in XBPI-RS485 operating mode

Connections Options

The following **printers** can be connected to **COM1 and UniCOM**

- YDP20 (user-defined interface parameters)
- YDP14IS (strip or label printer)
- YDP04IS (strip or label printer)
- Universal printer (user-defined transmission parameters)

The following devices can also be connected to **COM1**:

- Foot / Hand switch
- PC (RS-232 interface)
- 2nd weighing platform (Combics 2 only, RS-232 interface)
- External checkweighing display (stop light) via a digital I/O (Sartorius standard)

The following devices can also be connected to the **optional UniCOM**:

- PC (RS-232 interface)
- 2nd weighing platform (Combics 2 only, in RS-232 or RS-485 mode)
- 2nd printer (external power source required)
- Remote display
- Current interface (4-20 mA, 0-20 mA, 0-24 mA, 0-10 V)
- Profibus
- Ethernet
- Galvanically isolated digital I/O



You may need to use an external power supply to operate peripheral devices.

Connecting a second weighing platform:

A second weighing platform can be connected to the Combics 2 at COM1, UniCOM or COM-WP.

COM1 is operated in the RS-232 mode. A second weighing platform can use the following operating modes:

- SBI standard
- SBI verifiable
- XBPI-232 (factory setting)
- ADC-232

UniCOM can be operated in either RS-232 or RS-485 mode. A second weighing platform can use the following operating modes:

- SBI (RS-232 mode)
- XBPI-232 (RS-232 mode)
- ADC-232 (RS-232 mode)
- IS-485 (RS-485 mode, XBPI mode, factory setting)
- ADC-485 (RS-485 mode)

Connecting a printer

The COM1 standard interface, the optional UniCOM universal interface or both can be used as a printer interface.

Use as a communications interface

The data protocol can be set to the following operating modes for operation as a communications interface:

- SBI (factory setting)
- XBPI-232
- XBPI-485 (UniCOM only)
- MP8 binary (COM1 only)
- SMA
- Profibus
- Ethernet

Both communication interfaces can be operated independent of each other (e.g. data transfer and control via a PC using the optional UniCOM interface with simultaneous printing via the COM1 printer interface). During data communication, each interface can use a different protocol, e. g. Com1 with SMA and UniCom with XBPI.

In SBI operation, an indicator and connected weighing platform can be controlled using ESC commands from the PC via the communications interface (COM1 or UniCOM) (see page 105).

Each device can only be configured once for two interfaces (COM1 and UniCOM).

Device include:

- WP-2
- Analog output

If you attempt to reconfigure a device that has already been configured to another interface (e.g. WP2 to COM-1) a second time (to UniCOM), the error message *INF 74* appears.

Configuring the Data Interface as a COM Port (*DATPROT*)

You can configure the interface as a COM port in either COM1 or UniCOM, “Data Protocol” (*DATPROT*) menu item.

SBI communication

This is a simple ASCII interface.

Data output is configured under menu items 6.1 and 6.3:

- Manual output of displayed value with or without stability (menu items 6.1.1 and 6.1.2)
- Automatic output of displayed value with or without stability (menu items 6.1.4 and 6.1.5) at intervals defined by display updates. The number of display intervals is set in menu item 6.3.
- Output of a configurable printout (menu item 6.1.7). Output is linked to the “Printouts” menu item (*DATPROT*), (see page 96 “Configuring Printouts”)

If you do not activate and configure a user-definable data record, the printout simply contains the current value displayed on the display and control unit (weight with unit, calculated value, alphanumeric display).

SMA communication

Standardized communications protocol of the Scale Manufacturers Association

MP8 binary

Using the MP8 interface, you can connect MP8 generation peripheral devices with their own power supply to Combics.

- The scale is only used to determined the weight value
- The data interface only supplies the MP8 binary protocol
- The application program for MP8 can be selected under menu item 3
- The program index 2 for MP8 can be selected under menu item 4
- The MP8 interface cannot be used in legal metrology

Profibus

See special description

Ethernet

- With the SBI, SMA and XBPI communications protocol
- Modbus/TCP similar to the profibus data format

















Data Input Format

You can connect a computer to your scale to send commands controlling weighing instrument functions and applications via the interface port.

All commands use the same data input format. They start with the **ESC** character (ASCII 27) and end with a carriage return (**CR**; ASCII 13) and a line feed (**LF**; ASCII 10). The total length of a command is anywhere from 4 characters (1 command character between the start and end described above) to max. 7 characters (4 command characters). This number can also be higher when sending texts.

The commands listed in the following table must each be supplemented with ESC ... CR LF.

Example: The command character for output is “P” (“output to Port”). To trigger this command, send the string: “ESC P CR LF”.

Command	Meaning
K	Weighing mode 1
L	Weighing mode 2
M	Weighing mode 3
N	Weighing mode 4
O	Block keys
P	Send display value to data interface
Q	Output acoustic signal
R	Unblock keys
D	Tare and zero (combination tare function)
f3_	Zero (see also the “kZE_” command)
f4_	Tare without zeroing (see also the “kT_” command)
i_	Information about the indicator, example of output: “C2/016202/1” Explanation: Indicator: Combics 2, software version: 016202, active weighing platform: 1
kF1_	F1: Trigger  key function
kF2_	F2: Trigger  key function (Combics 2 only)
kF3_	F3: Trigger  key function (Combics 2 only)
kF4_	F4: Trigger  key function (Combics 2 only)
kF5_	F5: Trigger  key function (Combics 2 only)
kF6_	F6: Trigger  key function (Combics 2 only)
kF7_	F7: Trigger  key function (Combics 2 only)
kF8_	F8: Trigger  key function (Combics 2 only)
kF9_	F8: Trigger  key function (Combics 2 only)
kF10_	F8: Trigger  key function (Combics 2 only)
kF11_	F8: Trigger  key function (Combics 2 only)
kF12_	F8: Trigger  key function (Combics 2 only)
kCF_	CF: Trigger  key function (Combics 2 only)
kP_	Trigger  key function Print at printer interface
kT_	Trigger  key (tare)
kNW_	Trigger  key function (toggle the weighing platform)
kZE_	Trigger  key function (zero the instrument)
x1_	Output model designation of active weighing platform, example: “LP6200S-0C”
x2_	Output serial number of active weighing platform, example: “0012345678”
x3_	Output software version of active weighing platform, example: “00-42-04”
x4_	Output software version of indicator, example: “01-62-01”
x9_	Output serial number of indicator, example: “0012345678”
x10_	Output model of indicator, example: “CAW2P4-1500RR-LCE”
z1_	Input: printout header 1
z2_	Input: printout header 2
txx...x_	xx...x: text input, length corresponds to input, for display in the measured value line

The ASCII code for the “underline” character (“_”) is 95.

Format for entering printout header lines: “ESC z x a ... a _ CR LF” with x=1 or 2 and a ... a: 1 to 20 characters for header x, followed by the underline, CR and LF characters.

Data Output Format

Each line in a print job can contain up to 22 characters (up to 20 printable characters plus two control characters). The first 6 characters, called the “data header”, identify the subsequent value. You can suppress the header under menu item 7.2 in the “Printouts” menu; in this case, the print job has up to 16 characters (up to 14 printable characters plus two control characters).

Example: Output Without an ID Code + 253 pcs 16 characters are printed

Example: Output With an ID Code Qnt + 253 pcs 22 characters are printed

Display segments that are not activated are output as spaces. Values with no decimal point are output without a decimal point.

Data Output Format with 16 Characters (without Data Header)

Normal Operation

Position	1	2	3	4	5	6	7	8	9	10	11	12	13	14	15	16
	+	*	A	A	A	A	A	A	A	*	E	E	E	CR	LF	
or	-	*	A	A	A	A	A	A	A	*	E	E	E	CR	LF	
or	*	*	*	*	*	*	*	*	*	*	*	*	*	CR	LF	

+ -: Plus or minus sign

*: Space

A: Digit or letter (max. 7 characters plus decimal point)

E: Unit symbol (1 to 3 letters followed by 2-0 spaces)

CR: Carriage return

LF: Line feed

Special Codes

Position	1	2	3	4	5	6	7	8	9	10	11	12	13	14	15	16
	*	*	*	*	*	*	-	-	*	*	*	*	*	*	CR	LF
or	*	*	*	*	*	*	H	*	*	*	*	*	*	*	CR	LF
or	*	*	*	*	*	*	H	H	*	*	*	*	*	*	CR	LF
or	*	*	*	*	*	*	L	*	*	*	*	*	*	*	CR	LF
or	*	*	*	*	*	*	L	L	*	*	*	*	*	*	CR	LF
or	*	*	*	*	*	*	L	*	*	*	*	*	*	*	CR	LF

*: Space

--: Final readout

H: Overload

HH: Overload in checkweighing

L: Underweight

L L: Underweight in checkweighing

C: Calibration/Adjustment

Error Message

Position	1	2	3	4	5	6	7	8	9	10	11	12	13	14	15	16
	*	*	*	E	r	r	*	*	#	#	*	*	*	*	CR	LF
	*	*	*	E	r	r	*	*	#	#	#	*	*	*	CR	LF
*	Space															
#:	Number (2 or 3 digit error number)															

Example: Output weight value of +1255.7 g

Position	1	2	3	4	5	6	7	8	9	10	11	12	13	14	15	16
	+	*	*	*	1	2	5	5	.	7	*	g	*	*	CR	LF

- Position 1: Plus +, or minus - or space
- Position 2: Space
- Positions 3-10: Weight value with decimal point; leading zeros are output as spaces.
- Position 11: Space
- Positions 12-14: Characters for unit of measure, space or ! sign as a symbol
- Position 15: Carriage return
- Position 16: Line feed

Data Output Format with 22 Characters

Normal Operation

1	2	3	4	5	6	7	8	9	10	11	12	13	14	15	16	17	18	19	20	21	22	
K	K	K	K	K	K	+	A	A	A	A	A	A	A	A	*	E	E	E	CR	LF		
K	K	K	K	K	K	-	A	A	A	A	A	A	A	A	*	E	E	E	CR	LF		
*	*	*	*	*	*	*	*	*	*	*	*	*	*	*	*	*	*	*	*	*	CR	LF

- K: ID code character, right-justified with spaces
- +-: Plus or minus sign
- *: Space
- A: Digit or letter (max. 7 characters plus decimal point)
- E: Unit symbol (1 to 3 letters followed by 2-0 spaces)
- CR: Carriage return
- LF: Line feed

Special Codes

1	2	3	4	5	6	7	8	9	10	11	12	13	14	15	16	17	18	19	20	21	22
S	t	a	t	*	*	*	*	*	*	*	*	-	-	*	*	*	*	*	*	CR	LF
S	t	a	t	*	*	*	*	*	*	*	*	H	*	*	*	*	*	*	*	CR	LF
S	t	a	t	*	*	*	*	*	*	*	*	H	H	*	*	*	*	*	*	CR	LF
S	t	a	t	*	*	*	*	*	*	*	*	L	*	*	*	*	*	*	*	CR	LF
S	t	a	t	*	*	*	*	*	*	*	*	L	L	*	*	*	*	*	*	CR	LF
S	t	a	t	*	*	*	*	*	*	*	*	C	*	*	*	*	*	*	*	CR	LF

- *: Space
- : Final readout
- H: Overload
- HH: Overload in checkweighing
- L: Underweight
- LL: Underweight in checkweighing
- C: Calibration/Adjustment

Error message

```

1  2 3 4 5 6 7 8 9 10 11 12 13 14 15 16 17 18 19 20 21 22
S  t a t * * * * * E r r * * # # * * * * CR LF
S  t a t * * * * * E r r * # # # * * * * CR LF

```

*: Space

#: Number (2 or 3 digit error number)

G#	Gross value		
N	Net value	Max	Upper tolerance for checkw.
T	Application tare memory 1	Min	Min. tolerance for checkw.
T2	Application tare memory 2	Stat	Status
Diff	Difference from calibration value	Classx	Classification
Targ.	Exact adjustment weight value	Limx	Class limit
Nom.	Exact calibration weight for SBI protocol output	D	Percentage (as loss)
nRef	Reference sample quantity	Prc	Percentage (as residue)
pRef	Percentage of reference	Wxx%	Reference percentage weight
wRef	Reference piece weight	Cmpxxx	Component xxx
Qnt	Result from Counting (piece count) and Neutral Measurement applications	Cont.T	Contents of the tare memory in Net-total Formulation
mDef	Target value for animal weighing	S-Comp	Total of initial weighings for Net-total formulation
x-Net	Animal weighing results	PT2	Preset tare
Setp	Target value for checkweighing	n	Transaction counter
Diff.W	Absolute difference (e.g., in kg) in Checkweighing	*G	Sum of gross weights in Totalizing
Lim	Deviation in % in Checkweighing	*N	Sum of net weights in Totalizing
		Ser.no	Serial number of the platform or indicator

Example: Output weight value of +1255.7 g

```

1  2 3 4 5 6 7 8 9 10 11 12 13 14 15 16 17 18 19 20 21 22
G # * * * * * + * * * 1 2 5 5 . 7 * g * * CR LF

```

Positions 1-6: ID code, right-justified with spaces

Position 7: Plus +, or minus - or space

Position 8: Space

Positions 9-16: Weight value with decimal point; leading zeros are output as spaces (a comma can also be set instead of a decimal point, menu item 7.17).

Position 17: Space

Positions 18-20: Characters for unit of measure, space or ! sign as a symbol

Position 21: Carriage return

Position 22: Line feed



If the weight value is output with 10-fold increased resolution, this value is not permitted to be printed or saved in a weighing instrument operated in legal metrology in the SBI mode. In this case, the unit symbol is not included with output.

















External Keyboard Functions (PC Keyboard)

Setting: `SETUP / BARCODE / EXT.KEYB`

The alphanumeric key codes implemented here are specific to the German keyboard layout. The following alphanumeric characters are used (some require the “Shift” key):

a - z, A - Z, 0 - 9, <space>, and these characters: „\+’<>/»\$@%/();=:_?*

Function keys:



PC keyboard	Combics 2
F1	 key
F2	 key
F3	 key
F4	 key
F5	 key
F6	 key
F7	 key
F8	 key
F9	 key
F10	 key
F11	 key
F12	 key
Print	 key
Return	 key
Pos 1	 key
Backspace	 key
ESC	 key

Configuring Data Interface as a Printer Port (*PRINTER*)

You can connect one or two strip printers or one or two label printers to the Combics. Configure the COM1 and UniCOM interfaces as printer ports in the Printer menu item.

There are several actions that generate the command for outputting data to the printer port:

- Pressing the  key.
If the operating menu is active, all menu settings under the active menu level are printed.
- Upon receipt of the “*ESC K P _*” SBI command.
For details, see the section entitled “Data Input Format” in this chapter.
- In some applications, pressing a given key (e.g., to save a value or start a routine) also generates a print command. In this case, a configurable printout is generated with application-specific data.

The  and  symbols are displayed when data is being output to the printer port.

Configuring Printouts

Printouts are configured in the *SETUP* menu under “Printouts” (*SETUP / PRINT / PROTOCOL*). This should be carried out **after** configuring the application since some data in the printout is application-dependent.

You can configure a separate printout for each interface. Each printout is comprised of different information blocks that can be activated or deactivated via multiple selection in the menu.

Combics 2 only: For the “Totalizing” and “Net-total Formulation” applications, the totalizing/results printout can be configured independent of the individual/component printout.

Headers

2 headers each with a max. of 20 characters are available (e.g. for printing the company name).

Input: menu items 7.4.1 and 7.4.2.

Empty headers are not printed:

Example Print image:

```

ACE HARDWARE
GOETTINGEN

```

In this example, the company name is printed centered because there are 4 and 5 spaces before the text.

GMP-compliant printouts

When this function, the printout is supplemented with a GMP header and a GMP footer (GMP: “Good Manufacturing Practice”).

Setting: Menu item 7.13.

The GMP header precedes the first measured result. The GMP footer is printed either after each individual measurement result (“GMP-compliant printout always for 1 result.” menu item 7.13.2) or after the last result in a series of measurements (“GMP-compliant printout always for several application results,” menu item 7.13.3). To end a series of measured results, press and hold the \overline{E} key. In this case, the \overline{E} symbol is displayed after the GMP header is printed and remains in the display until the GMP footer is printed.

If you toggle to a different platform (Combics 2 only) while a GMP printout of several measured results is being generated (menu item 7.13.3), the GMP footer for the platform used up to that point is generated when you press the \overline{AVA} key. The GMP header for the other platform is included on the next printout generated. A GMP-compliant printout is generated automatically at the conclusion of calibration/adjustment, linearization routines, as well as when you set or clear a preload.

When printing GMP-compliant printouts on label printers under menu setting 7.13.3, the relationship between the GMP header and footer is lost (printed on different labels). GMP-compliant printouts on label printers, therefore, should only take place using menu setting 7.13.2.

Three examples of GMP headers and one example of a footer are shown in the following. On Combics 1 models, the “date and time” line is not included.

1) = Combics 2 only

Weighing platform WP 1:

```

----- Dash line
14.01.2012    09:43 Date/Time 1)
Type          CAISL2  Combics type
Ser.no.       12345678 Combics serial no.
Vers.  C2 100.280810 Software version of application
BVers.       01-62-01 Software version of basic version
----- Dash line

```

Weighing platform WP 2 (XBPI protocol): ¹⁾

```

----- Dash line
14.01.2012    09:45 Date/Time
Type          CAISL2  Combics type
Ser.no.       12345678 Combics serial no.
Vers.  C2 100.280810 Software version of application
BVers.       01-62-01 Software version of basic version
Type          IS12000S Platform type
Ser.No       12345678 Platform serial no.
----- Dash line

```

Weighing platform WP 2 (SBI protocol): ¹⁾

```

----- Dash line
14.01.2012    09:45 Date/Time
Type          CAISL2  Combics type
Ser.no.       12345678 Combics serial no.
Vers.  C2 100.280810 Software version of application
BVers.       01-62-01 Software version of basic version

```

```

Type          SBI (Platform type)
----- Dash line

```

GMP footer:

```

----- Dash line
14.01.2012    09:45 Date/Time 1)
Name:         Field for signature
              Blank line
----- Dash line

```

¹⁾ for Combics 2 indicator only

Sample Printouts

For details on the individual information blocks, see "Configuring Printouts", above. For details on configuring the header lines, refer to the chapter of the respective application.

"Weighing" application:

If selected, an empty line will be printed.

```

          HEADER LINE1
          HEADER LINE2
14.01.2012      09:43
-----
G#      +      1.402 kg
T       +      0.200 kg
N       +      1.202 kg
-----

```

Display with ID of weighing platform

```

-----
Ser.no.      80705337
-----
G#      +      1.402 kg
T       +      0.200 kg
N       +      1.202 kg
-----

```

"Counting" application:

The initialization data contains the reference sample quantity and the reference sample weight. The results data contains gross, net and tare weight and the piece count as a result.

```

-----
nRef          10 pcs
wRef +      0.035 kg
-----
G#      +      1.402 kg
T       +      0.212 kg
N       +      1.190 kg
-----
Qnt          34 pcs
-----

```

"Neutral Measurement"

application:

The initialization data block contains the reference sample quantity and reference weight. The results block contains gross, net and tare weight and the piece count as a result.

```

-----
Ref          2 o
wRef +      1.200 kg
-----
G#      +      14.700 kg
T       +      0.300 kg
N       +      14.400 kg
-----
Qnt          12 o
-----

```

"Weighing in Percent" application:

The initialization data contains the reference percentage and the reference sample weight. The results data shows gross, net and tare weights, as well as the percentage, which is shown as either the loss or the residual amount. Percentage = residue:

```

-----
pRef          100 %
Wxx% +      2.100 kg
-----
G#      +      1.859 kg
T       +      0.200 kg
N       +      1.659 kg
-----
Prc          79 %
-----

```

Percentage = loss:

```

-----
pRef          100 %
Wxx% +      2.100 kg
-----
G#      +      0.641 kg
T       +      0.200 kg
N       +      0.441 kg
-----
D          21 %
-----

```

"Checkweighing" application:

The initialization data contains the target weight, the min. weight and the max. weight. The results data always contains the gross, net and tare weight. Additional results can be printed in 2 different display types:

– Weight display:

In the OK and nonconforming range, the deviation from the target weight is always printed as a percentage and absolute deviation.

– Relation to target value:

In the OK range, the deviation from the target weight is printed as a percentage and absolute deviation. In the nonconforming range, "HH" is printed for exceeding the weight and "LL" for falling below the weight.

OK range in the weight and tolerance limit display

```

-----
Setp +      1.300 kg
Min  +      1.235 kg
Max  +      1.365 kg
-----
G#      +      1.312 kg
T       +      0.000 kg
N       +      1.312 kg
-----
Lim  +      0.92 %
Diff.W+ 0.012 kg
-----

```

Result outside (over) "OK" range; "Threshold" printout:

```

-----
Setp +      1.300 kg
Min  +      1.235 kg
Max  +      1.365 kg
-----
G#      +      1.400 kg
T       +      0.000 kg
N       +      1.400 kg
-----
Stat      HH
-----

```

Example with 2 transactions:

```

HEADER LINE1
HEADER LINE2
14.01.2012      09:43
-----
G#   +   1.400 kg
T    +   0.200 kg
N    +   1.200 kg
n                1

G#   +   3.400 kg
T    +   0.200 kg
N    +   3.200 kg
n                2
    
```

Single printout (menu setting 3.17.2)

Complete standard printout configuration is printed for each transaction.

Example: print 2nd translation

```

HEADER LINE1
HEADER LINE2
14.01.2012      09:43
-----
G#   +   2.400 kg
T    +   0.200 kg
N    +   2.200 kg
n                2
    
```

Standard printout

The transaction counter is not printed.

Example: print 2nd translation

```

G#   +   2.400 kg
T    +   0.200 kg
N    +   2.200 kg
    
```

Print menu parameters:

All active sub-items of the currently displayed menu are printed:

```

-----
MENU
      SETUP
WP1
-----
  1
  1.1
      1.1.2
      1.2.1
1.3.2
...
  1.18
  1.18.1
    CAL.
      10.000 kg
etc.
    
```

GMP-compliant printouts

```

Linearization printout
-----
14.01.2012      13:00
Type            CAISL2
Ser.no.         12345678
Vers.  C2 100.280810
BVers.         01-62-01
-----
    
```

```

Linearization
Wt.1 +   7.00 kg
Wt.2 +  15.00 kg
Wt.3 +  22.00 kg
Wt.4 +  30.00 kg
-----
                    completed
    
```

```

-----
14.01.2012      13:02
Name:
-----
    
```

```

-----
Calibration/adjustment printout
-----
14.01.2012      13:50
Type            CAISL2
Ser.no.         12345678
Vers.  C2 100.280810
BVers.         01-62-01
-----
    
```

```

External calibration
Tar. +   30.00 kg
Diff. -   0.03 kg
External adjustment
Diff. +   0.00 kg
-----
    
```

```

-----
14.01.2012      13:52
Name:
-----
    
```

```

-----
Setting the preload printout
-----
14.01.2012      13:50
Type            CAISL2
Ser.no.         12345678
Vers.  C2 100.280810
BVers.         01-62-01
-----
    
```

```

-----
Setting the preload
                    completed
-----
14.01.2012      13:52
Name:
-----
    
```

Clearing the preload printout

```

-----
14.01.2012      13:50
Type            CAISL2
Ser.no.         12345678
Vers.  C2 100.280810
BVers.         01-62-01
-----
    
```

Clearing the preload completed

```

-----
14.01.2012      13:52
Name:
-----
    
```

Weighing printout with multiple results (Example with 2 results):

```

-----
14.01.2012      09:43
Type            CAISL2
Ser.no.         12345678
Vers.  C2 100.280810
BVers.         01-62-01
-----
    
```

```

HEADER LINE1
HEADER LINE2
14.01.2010      09:43
-----
G#   +   2.40 kg
T    +   0.20 kg
N    +   2.20 kg
-----
    
```

```

HEADER LINE1
HEADER LINE2
14.01.2012      09:44
-----
G#   +   3.40 kg
T    +   0.30 kg
N    +   3.10 kg
-----
    
```

```

-----
14.01.2012      09:45
Name:
-----
    
```

Error Messages

Errors are divided into the following:

- Dynamic errors are displayed for the duration of the error with an error code (e.g. *INF 01*).
- Temporary errors are displayed for 2 seconds (e.g. *INF 07*)
- Fatal errors are displayed continuously (e.g. *ERR 101*, a reset is required to clear them).

Display	Cause	Solution
No display segments	No power present	Check power supply
-----	Key has no function in this status	
Flashing ▲	Battery defective or time changed	Set time
<i>H</i>	Weighing range exceeded	Unload the scale
<i>L</i> or <i>ERR 54</i>	Weighing pan is not in place	Position the weighing pan
<i>ERR 101 - 104</i>	Key is stuck	Release key or key pressed when switching on the device Contact your local Sartorius Service Center
<i>ERR 320</i>	Operating program memory faulty	Contact your local Sartorius Service Center
<i>ERR 335</i>	Verified weighing platform not compatible with the connected terminal	Connect a compatible weighing platform
<i>ERR 340</i>	New EEPROM loaded (Service)	Turn the scale off and then on again. If the error code Err340 is still displayed, please contact your local Sartorius Service Center
<i>ERR 341</i>	RAM has lost data; battery is dead	Leave the scale connected to power for at least 10 hrs.
<i>ERR 343</i>	Loss of data in the memory area for transaction numbers External alibi memory	Contact your local Sartorius Service Center
<i>INF 01</i>	Data output not compatible with output format	Set output format correctly
<i>INF 02</i>	Adjustment condition was not met e.g. not tared or weighing pan loaded	Do not carry out adjustment until after 0 display Unload scale, tare using the ↔T↔ key
<i>INF 03</i>	Adjustment could not be completed within a certain time	Allow to warm up again and repeat the adjustment process
<i>INF 06</i>	Built-in calibration weight defective	Contact your local Sartorius Service Center
<i>INF 07</i>	Function not allowed in scales verified for use in legal metrology	Contact your local Sartorius Service Center
<i>INF 08</i>	The load on the scale is too heavy to zero the readout	Check whether "Tare/zero at power on" (1.12) is set
<i>INF 09</i>	Taring is not possible when the scale gross weight is < zero	Zero the scale
<i>INF 10</i>	Tare key is blocked when there is data in the tare memory	The data stored for the application program must be deleted before taring (Combics 2 only).
<i>INF 18</i>	Preload is too light	
<i>INF 19</i>	Preload is too heavy	
<i>INF 29</i>	Minimum load not reached	Reduce min. load (under Application, menu item 3.6)
<i>INF 30</i>	BPI ID (BPI byte) not deleted in current weighing platform	Reset weighing parameters to factory settings for current (COM1 is fixed on XBPI data communication) weighing platform
<i>INF 31</i>	Interface handshake interrupted (XOFF, CTS)	Send XON, unblock CTS
<i>INF 71</i>	Cannot store the current weight value (e.g. control limits too low or too high)	None
<i>INF 72</i>	Cannot store the current weight value (e.g. transaction counter maximum reached)	None
<i>INF 73</i>	Data cannot be written or read	Contact your local Sartorius Service Center
<i>INF 74</i>	Function is blocked (e.g. menu is locked, device is already configured to another interface)	None
<i>NOWP</i>	No weighing platform connected	Connect a weighing platform

Care and Maintenance

Service

Regular servicing by a Sartorius technician will extend the service life of your device and ensure its continued weighing accuracy. Sartorius offers its customers service contracts with regular maintenance intervals ranging from one month to two years. The frequency of the maintenance intervals depends on the operating conditions and the operator's tolerance requirements.

Repairs



Disconnect the power supply to the defective equipment immediately (unplug the power cord from the mains supply). Repair work must be performed by authorized Sartorius service technicians using original spare parts. Repairs performed by untrained persons may result in considerable hazards for the user.



If a cable or cable gland is damaged or defective, replace the cable as a complete unit with all its connectors.



Do not open the indicator while it is carrying current. Wait at least 10 seconds after disconnecting it from power before beginning to open the equipment. Proper fitting of all surfaces is essential for the IP rating of the housing; for this reason the device must be opened and closed by a certified technician.

Cleaning

Indicators are designed in compliance with European Hygienic Equipment Design Group (EHEDG) directives on suitable measures to avoid contamination, so that they are particularly easy to clean and disinfect.



Disconnect the power supply to the indicator (unplug the power cord from the mains supply). If necessary, disconnect the data cable.



Make sure that no liquid enters the indicator.



Do not use aggressive cleaning agents (solvents or similar agents).



Do not spray the device with water or blow with compressed air.

- ▶ Clean the indicator with a cloth lightly moistened with a soap solution. For use in the food industry, use a cleaning agent suitable for that particular working environment.
- ▶ Wipe the indicator with a soft, dry cloth.

Cleaning the stainless steel surfaces

- Only use conventional household cleaning agents which are suitable for stainless steel.
- Only use solvents for cleaning stainless steel parts.
- ▶ All stainless steel parts should be cleaned at regular intervals: Rub stainless steel surfaces with a moist cloth, with a cleaning agent if required, then remove all residue from the surface.
- ▶ Allow device to dry. For additional protection, protective oil may be applied.

Replacing the dust cover

A damaged dust cover should be replaced immediately.

- ▶ Remove damaged dust cover.
- ▶ Place the new dust cover on the display and control unit and press it over the edge of the front and rear side of the device until it is fixed in place.

Safety Inspection

Safe operation of the device is no longer ensured when:

- The device or the mains connecting lead shows visible damage.
- The integrated power supply for the indicator no longer functions properly.
- The device has been stored for a relatively long period under unfavorable conditions (e.g., excessive humidity)

If there is any indication that safe operation of the device is no longer warranted:

- ▶ Disconnect the power supply to the device (unplug the power cord from the mains supply) and make sure the device cannot be used for the time being.
- ▶ Notify your nearest Sartorius Service Center.

Maintenance and repair work may only be carried out by service technicians:

- Who have access to the required maintenance documents and manuals and
- Who have attended the appropriate training workshops



The seals on the device indicate that the device may only be opened and maintained by authorized specialist personnel, so that the correct and safe operation of the device is ensured and the guarantee remains valid.

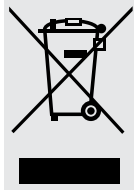

Disposal

The packaging is to be taken to a local waste disposal site if no longer required. The packaging is made of environmentally friendly materials that can be used as secondary raw materials.

The equipment, including accessories and batteries, should not be disposed of as regular household waste. EU legislation requires its Member States to collect electrical and electronic equipment and dispose of it separately from other unsorted municipal waste so that it may be recycled.

In Germany and several other countries, Sartorius itself assumes responsibility for the return and conformant disposal of its electronic and electrical products. These products may not be placed with household waste or brought to collection centers run by local public disposal operations – not even by small commercial operators. For disposal in Germany and in the other member nations of the European Economic Area (EEA), please contact our local service technicians or our Service Center in Goettingen, Germany:

Sartorius
 Weender Landstrasse 94-108
 37075 Goettingen, Germany

SWT GÖ: WEEE-Reg.-Nr. DE 49923090

In countries that are not members of the European Economic Area (EEA) or where no Sartorius subsidiaries or dealerships are located, please contact your local authorities or a commercial disposal operator.

Prior to disposal and/or scrapping of the equipment, any batteries should be removed and disposed of in local collection boxes.

Sartorius will not take back equipment contaminated with hazardous materials (ABC contamination) – either for repair or disposal. Please refer to our website (www.sartorius.com) or contact the Sartorius Service Department for more detailed information regarding repair service addresses or the disposal of your device.

Technical Data

ADC scale interface 2*3000e (option A8)

When used in standard applications (as opposed to legal metrology):

- Display resolution ≤ 31250 d
- Lowest permissible input signal 625 d

Using the Equipment in Legal Metrology:

Accuracy class III , III

Verification scale intervals when used as:

- Single-range scale $\leq 3125e$
- Multi-interval scale $\leq 3125e$

Maximum e1 6250e

- Multiple-range scale $\leq 3125e$

Load cell connection:

- Supply voltage 8.4 V (± 4.2 V)
- Bridge impedance 83 Ω up to 2000 Ω
- Available sensor technology 4-conductor or 6-conductor technology

When used in legal metrology:

- Available sensor technology 6-conductor technology
- Max. cable length per gauge 150 m/mm²
- Lowest permissible input signal
for Pind = 0.5 0.672 $\mu\text{V}/e$
for Pind = 0.3 1.12 $\mu\text{V}/e$
- Fraction of tolerance for this module:
for $\Delta U_{\min} \leq 0.672 \mu\text{V}/e$ 0.5
for $\Delta U_{\min} \leq 1.12 \mu\text{V}/e$ 0.3

Measuring signal 0 mV to 27.7 mV

Measuring signal variation 4.2 mV to 27.7 mV

Sensitivity 4 million digits max. (internal)

Digital protective interface According to EN45501

Data interface Bidirectional RS-232 interface
with control outputs (5V, TTL standard)

Other data interfaces: Optional

Display 20 mm LCD, 7-segment plus status symbols, backlit

Housing:

- Material Stainless steel 1.4301
- Protection class according to EN60529 CAISL1, CAISL2: IP44 (IP65 as accessory)
CAIS1, CAIS2: IP69K

Temperature range -10°C to $+40$

Power supply 100-240 V AC ($-10/+10\%$), 50-60 Hz,
max. 17 W / 23 VA
optional 15.5-24 V DC ($\pm 10\%$), max. 12 W
optional 13-17 V AC ($\pm 10\%$), 50-60 Hz, max. 12 W

Emissions According to EN61326-1 Class B (IEC 61326-1)

Defined immunity to interference According to EN61326-1, industrial areas (IEC 61326-1)

Electrical safety According to EN61010-1 (IEC 1010-1)

ADC scale interface 10,000e (option A10, A20)

When used in standard applications (as opposed to legal metrology):

- Display resolution $\leq 100,000$ d
- Lowest permissible input signal 1510 d

Using the Equipment in Legal Metrology:

Accuracy class $\textcircled{\text{III}}$, $\textcircled{\text{III}}$

Verification scale intervals when used as:

- Single-range scale ≤ 10000
- Multi-interval scale ≤ 3125

Maximum e_1 ≤ 15100

- Multiple-range scale ≤ 3125

Load cell connection:

- Supply voltage 8.2 V (± 4.1 V)
- Bridge impedance 83Ω up to 2000Ω
- Available sensor technology 4-conductor or 6-conductor technology

When used in legal metrology:

- Available sensor technology 6-conductor technology
- Max. cable length per gauge 150 m/mm^2
- Lowest permissible input signal
 - for $P_{\text{ind}} = 0.5$ $0.328 \mu\text{V/e}$
 - for $P_{\text{ind}} = 0.3$ $0.546 \mu\text{V/e}$
- Fraction of tolerance for this module:
 - for $\Delta U_{\text{min}} \leq 0.328 \mu\text{V/e}$ 0.5
 - for $\Delta U_{\text{min}} \leq 0.546 \mu\text{V/e}$ 0.3

Measuring signal 0 mV to 24.6 mV

Measuring signal variation 3.28 mV to 24.6 mV

Sensitivity 4 million digits max. (internal)

Digital protective interface According to EN45501

Data interface Bidirectional RS-232 interface
with control outputs (5V, TTL standard)

Other data interfaces: Optional

Display 20 mm LCD, 7-segment plus status symbols, backlit

Housing:

- Material Stainless steel 1.4301
- Protection class according to EN60529 CAISL1, CAISL2: IP44 (IP65 as accessory)
CAIS1, CAIS2: IP69K

Temperature range -10°C to $+40^\circ\text{C}$

Power supply 100-240 V AC ($-10/+10\%$), 50-60 Hz,
max. 17 W / 23 VA
optional 15.5-24 V DC ($\pm 10\%$), max. 12 W
optional 13-17 V AC ($\pm 10\%$), 50-60 Hz, max. 12 W

Emissions According to EN61326-1 Class B (IEC 61326-1)

Defined immunity to interference According to EN61326-1, industrial areas (IEC 61326-1)

Electrical safety According to EN61010-1 (IEC 1010-1)

Device Dimensions

All dimensions are given in millimeters

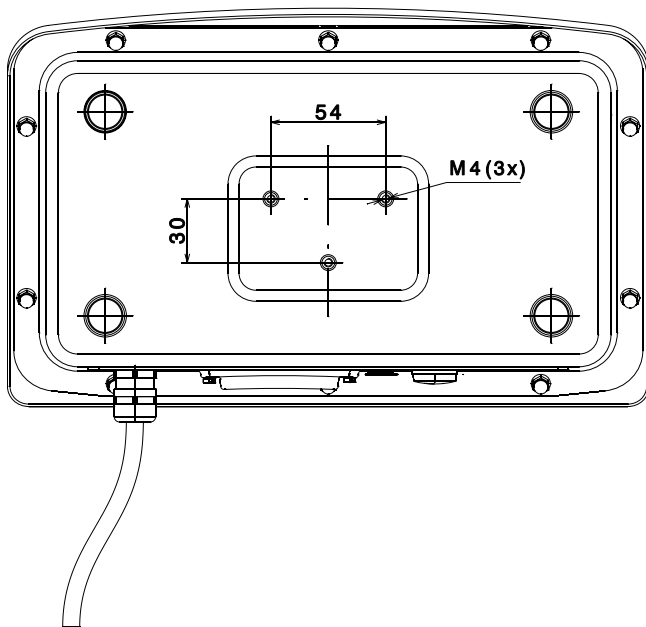
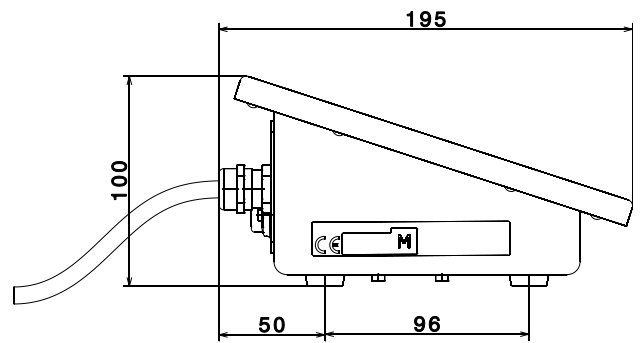
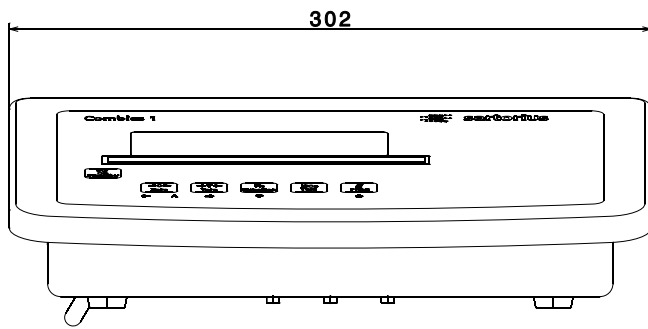

Accessories

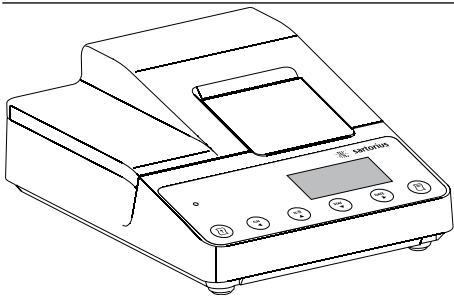

Product	Order No.
Verifiable data printer with date/time and statistics functions with LCD display.	YDP20-OCE
- 5 + 50 m paper rolls for data printer	6906937
- Replacement ink ribbon cartridge for printer	6906918



Verifiable strip and label printer with barcode printout, paper width 108 mm, with adapter cable (12-pin round male connector) and external power supply.	YDP14IS-OCEUV
Verifiable strip and label printer with barcode printout, paper width 60 mm, with adapter cable (12-pin round male connector) and external power supply.	YDP04IS-OCEUV
- Adapter cable for CAISL indicator	YCC01-01CISLM3
- Adapter cable for CAIS indicator	YCC02-R12F6



Verifiable strip and label printer with thermal print head, paper width 60 mm, with adapter cable (12-pin round male connector) and external power supply.	YDP14S-OCEUVTH
- Adapter cable for CAISL indicator	YCC01-01CISLM3
- Adapter cable for CAIS indicator	YCC02-R12F6
- Ink ribbon for YDP14IS-OCEUVTH	69Y03234
- 3 paper rolls for YDP04IS, 60 mm + 75 m, thermal paper	69Y03090
- Labels, small, + mm + 30 mm, 1000 labels	69Y03092
- Labels, medium, 58 mm + 76 mm, 500 labels	69Y03093
- Labels, large, 58 mm + 100 mm, 350 labels	69Y03094

Installation option as accessory of the optional UniCOM interface

	CAISL1 for installation in IP44 version	CAISL2/3 for installation in IP44 version	CAIS1/2/3 for installation in IP69K version	
Interface module (RS-232)	-	•	•	YD002C-232
Interface module (RS-485 and RS-485), electrically isolated	-	•	•	YD002C-485
Electrically isolated digital I/Os, 5 outputs and 5 inputs, freely configurable	-	•	•	YD002C-DIO
Analog current output, 0 – 20 mA, 4 – 20 mA, 0 – 10 V, 16 bit ¹⁾	-	•	•	YD002C-AO
Profibus DP interface module ¹⁾	-	-	•	YD002C-DP
Ethernet interface module	-	-	•	YD002C-ETH
Profibus adapter cable for CAIS (open cable ends on 9-pin, D-SUB plug) 30 cm				on request
Profibus adapter cable for CAISL (25-pin, D-SUB plug on 9-pin D-SUB socket), 30 cm				on request

¹⁾ suitable for use in zones 2 + 22

Product	Order No.
Combics 2: Replacement 1st weighing point/scale connection instead of internal A/D converter (3000e)	
Analog platform 10,000e	YDI02C-WPA
RS-232 interface for digital platform	YDI02C-WPD
RS-485 interface for digital platform	YDI02C-WPD
2nd weighing point/scale connection	
Analog platform 10,000e	YDI02C-WPA
RS-232 interface for digital platform	YDI02C-WPD
RS-485 interface for digital platform	YDI02C-WPD
External interface adapter	
Connection cable from RS-232 data interface to USB interface on the PC, D-SUB plug 25-pin, 2 m ¹⁾	YCC01-USBM2
Digital input/output module to connect Combics 2 to external control units, with 8 open collector outputs (50 mA) and 7 TTL-compatible inputs (0 - 30 V), YCC02-RELAIS01/02 connection cable required	YSB02
Relay box to connect Combics 2 to external control units, YCC02-RELAIS01/02 connection cable required	VF3033
Software	
SNLE Sartorius Nice Label Express Software	YAD02IS
WinScale for Windows	YSW03
SartoCollect	YSC02
Other functions	
Guard covers (x2)	YDC01CI
IP65 kit for cable connections (D-SUB 25)	on request
Cable gland for cables with diameter 4.5 to 9 mm, M16 x 1.5	YAS04CIS
Kit for control panel installation ²⁾	YAS07CI
Plug and socket set to connect similar weighing platforms to indicators (separable connection)	YAS99I
Stainless steel cable connection box for connecting up to 4 load cells in one platform or for external assembly, PR6130/64S	940536130642
Relay box to connect scale to external control units with 4 (5), relay outputs (250V/3A) and 1 optocoupler input (0 - 30V)	YSB01
Peripheral devices	
Control display red/green/red	YRD14Z
Remote display for Combics CAISL indicators	YRD02Z
Remote display, 7-segment, up to 45 mm character size	on request
Barcode scanner, 120 mm scanning width, with cable for connection to CAISL2	YBR03PS2
Foot switch, incl. D-Sub 25-pin T-connector	YFS01
Hand switch, incl. D-Sub 25-pin T-connector	YHS02
Flow control for pumps with analog or pulse interface	YFC02Z-V2
Flexible formatting options for printouts (e.g., barcodes, variable font sizes, graphics, etc.)	on request

1) Model CAISL only

2) Suitable for use in zones 2 + 22

Product	Order No.
Mechanical accessories	
Brackets for wall mounting, stainless steel	YDH02CIS
Floor-mounted column	YDH03CIP
Floor-mounted column, stainless steel	YDH03CIS
Base for installing floor-mounted column	YBP03CIP
Base for installing floor-mounted column, stainless steel	YBP03CIS
Mount for barcode scanner, to be attached to: floor-mounted column, bench stand, complete scale retainer	YBH01CWS
Plate for attaching a printer to the floor-mounted column or bench stand	YPP01CWS
Castor set (2 guide castors, 2 lockable castors) for YBP03CIP/S floor-column base	YRO03CI
Plug and socket set to connect similar weighing platforms to indicators (separable connection)	YAS99I
Electrical requirements	
24 V industrial power supply module ¹⁾	on request
External rechargeable battery pack, up to 40 h operation, incl. charger	YRB10Z
External rechargeable battery pack, up to 40 h operation, w/out charger	YRB10Z-R
Connection cable for CAIS (IP 69K)	
Connection cable with cable gland, open cable ends on Combics side	
– for barcode scanner YBR03FC, 5-pin DIN socket, 1 m	YCC02-BR02
– for printer YDP12/04IS, 9-pin D-SUB plug, 6 m	YCC02-D09M6
– for printer YDP20-OCE or PC, 9-pin D-SUB socket, 6 m	YCC02-D09F6
– for Sartorius scales, 25-pin D-SUB plug, 6 m	YCC02-D25M6
– for various accessories, 25-pin D-SUB socket, 6 m	YCC02-D25F6
– for Sartorius scales, 12-pin round plug, 6 m	YCC02-R12M6
– for various accessories and IS platforms, 12-pin. round plug socket, 6 m	YCC02-R12F6
– open cable ends, 6 m	YCC02-RELAIS02
Ethernet connection cable with cable gland and RJ45 plug, 7 m	YCC02-RJ45M7
Connection cable for CAISL (IP 44)	
Connection cable 25-pin D-SUB plug on Combics side	
– for printer YDP12/04IS, 9-pin D-SUB plug, 6 m	YCC01-01CISLM3
– for PC, 9-pin. D-SUB socket, 6 m	7357314
– for Sartorius scales, 25-pin. D-SUB plug, 3 m	YCCDI-01M3
– for various accessories, 25-pin. D-SUB socket, 6 m	7357312
– for Sartorius scales, 12-pin round plug, 3 m	YCC01-02ISM3
– for various accessories and IS platforms, 12-pin. round plug socket, 6 m	YCC01-03CISLM3
– open cable ends, 6 m	YCC02-RELAIS01
Connection cable from RS-232 data interface to USB interface on the PC, 25-pin D-SUB plug, 2 m	YCC01-USBM2

1) Suitable for use in zones 2 + 22

Documents List

Operating instructions

UniCom interfaces:	98647-004-24
Standard field bus interface	98646-002-04
Verifiable alibi memory	98647-004-40

Installation instructions

Use in Zone 2 and 22 potentially explosive atmospheres (option Y2)	98647-003-40
--	--------------

Sartorius Services

“Installation” service in Germany

Our “Installation” service package provides a range of important services that guarantee satisfactory work from your device:

- Installation
- Commissioning
- Inspection
- Instruction

You can request these services from our customer service using the “Installation Check No. 2” in the included warranty and service check folder.

Re-verification in Germany

Scale verification for legal metrology is valid until the end of the calendar year after next. If the scale is used for fill level control in accordance with legislation on prepackaging, verification is valid until the end of the following calendar year. Re-verification must currently be carried out by a weights and measures official. Re-verification should be requested in good time from the local Weights and Measures office. As appropriate, please observe all statutory amendments.

Subsequent Verifications within European Countries

The expiration date of the verification depends on the national regulations of the country in which the weighing instrument is used. For information on verification and legal regulations currently applicable in your country, and to obtain the names of the persons to contact, please contact your local Sartorius office, dealer, or Service Center.

Further information concerning verification can be obtained from our customer service centers.

Declaration of Conformity



CE EG-Konformitätserklärung EC Declaration of Conformity

Sartorius Weighing Technology GmbH
Weender Landstrasse 94 - 108
D-37075 Goettingen, Germany

erklärt in alleiniger Verantwortung, dass das Betriebsmittel
declares under own responsibility that the equipment

Geräteart: Combics Indikator
Device type: Combics indicator

Baureihe / Type series: CAIS1, CAIS2, CAIS3, CAISL1, CAISL2, CAISL3

in der von uns in Verkehr gebrachten Ausführung mit den grundlegenden Anforderungen der folgenden Europäischen Richtlinien übereinstimmt:
in the form as delivered complies with the basic requirements of the following European Directives:

Richtlinie 2004/108/EG Elektromagnetische Verträglichkeit
Directive 2004/108/EC Electromagnetic compatibility

Richtlinie 2006/95/EG Elektrische Betriebsmittel zur Verwendung innerhalb bestimmter Spannungsgrenzen
Directive 2006/95/EC Electrical equipment designed for use within certain voltage limits

Das Gerät erfüllt die anwendbaren Anforderungen folgender harmonisierten Europäischen Normen.
The apparatus meets the applicable requirements of the harmonized European Standards listed below.

1. Richtlinie 2004/108/EG | *Directive 2004/108/EC*
EN 61326-1:2006 Elektrische Mess-, Steuer-, Regel- und Laborgeräte - EMV-Anforderungen - Teil 1: Allgemeine Anforderungen
Electrical equipment for measurement, control and laboratory use - EMC requirements - Part 1: General requirements
2. Richtlinie 2006/95/EG | *Directive 2006/95/EC*
EN 61010-1:2010 Sicherheitsbestimmungen für elektrische Mess-, Steuer-, Regel- und Laborgeräte - Teil 1: Allgemeine Anforderungen
Safety requirements for electrical equipment for measurement, control, and laboratory use - Part 1: General requirements

Jahr der Anbringung der CE-Kennzeichnung | *Year of attachment of CE marking:* 12

Sartorius Weighing Technology GmbH
Goettingen, 2012-05-03

Dr. Reinhard Baumfalk
Vice President R&D

Dr. Dieter Klausgrete
Head of International Certification Management

Diese Erklärung bescheinigt die Übereinstimmung mit den genannten EG-Richtlinien, ist jedoch keine Zusicherung von Eigenschaften. Bei einer mit uns nicht abgestimmten Änderung des Produktes verliert diese Erklärung ihre Gültigkeit. Die Sicherheitshinweise der zugehörigen Produktdokumentation sind zu beachten.
This declaration certifies conformity with the above mentioned EC Directives, but does not guarantee product attributes. Unauthorised product modifications make this declaration invalid. The safety information in the associated product documentation must be observed.

SWT12CE016

65954-000-58-R01

SOP-3.RD-045-fo2



CE EG-Konformitätserklärung EC Declaration of Conformity

Sartorius Weighing Technology GmbH
Weender Landstrasse 94 - 108
D-37075 Goettingen, Germany

erklärt in alleiniger Verantwortung, dass das Betriebsmittel
declares under own responsibility that the equipment

Geräteart: <i>Device type:</i>	Indicator <i>Indicator</i>
Baureihe / <i>Type series:</i>	CAIS1, CAIS2, CAIS3 mit / with Option Y2

in der von uns in Verkehr gebrachten Ausführung mit den grundlegenden Anforderungen der folgenden Europäischen Richtlinien übereinstimmt:
in the form as delivered complies with the basic requirements of the following European Directives:

Richtlinie 2004/108/EG <i>Directive 2004/108/EC</i>	Elektromagnetische Verträglichkeit <i>Electromagnetic compatibility</i>
Richtlinie 2006/95/EG <i>Directive 2006/95/EC</i>	Elektrische Betriebsmittel zur Verwendung innerhalb bestimmter Spannungsgrenzen <i>Electrical equipment designed for use within certain voltage limits</i>
Richtlinie 94/9/EG <i>Directive 94/9/EC</i>	Geräte und Schutzsysteme zur bestimmungsgemäßen Verwendung in explosionsgefährdeten Bereichen <i>Equipment and protective systems intended for use in potentially explosive atmospheres</i>

Das Gerät erfüllt die anwendbaren Anforderungen der in Anhang 1 aufgeführten harmonisierten Europäischen Normen. Zu Angaben zur Richtlinie 94/9/EG siehe Anhang 2.

The apparatus meets the applicable requirements of the harmonized European Standards listed in Annex 1. For specifications regarding Directive 94/9/EC see Annex 2.

Jahr der Anbringung der CE-Kennzeichnung / *Year of attachment of CE marking:* 12

Sartorius Weighing Technology GmbH
Goettingen, 2012-05-14

Dr. Reinhard Baumfalk
Vice President R&D

Dr. Dieter Klausgrete
Head of International Certification Management

Diese Erklärung bescheinigt die Übereinstimmung mit den genannten EG-Richtlinien, ist jedoch keine Zusicherung von Eigenschaften. Bei einer mit uns nicht abgestimmten Änderung des Produktes verliert diese Erklärung ihre Gültigkeit. Die Sicherheitshinweise der zugehörigen Produktdokumentation sind zu beachten.

This declaration certifies conformity with the above mentioned EC Directives, but does not guarantee product attributes. Unauthorised product modifications make this declaration invalid. The safety information in the associated product documentation must be observed.

SWT12CE021

65954-750-58

SOP-3.RD-045-fo2

CE Konformitätserklärung zur Richtlinie 2009/23/EG *Dichiarazione di Conformità alla Direttiva 2009/23/CE*

nichtselbsttätige elektromechanische Waagen
strumenti per pesare elettromeccanici a funzionamento non automatico

(Alle Daten sind in den Prüfberichten, Bauartzulassungen oder den betroffenen Geräten selbst zu entnehmen)
(Tutti i dati sono contenuti nei certificati di prova, nei certificati di approvazione del tipo o negli strumenti in questione)

Auswerte- gerät <i>Indicatore</i>	Bauart Auswerte- gerät <i>Tipo di indicatore</i>	Bauart Waage <i>Tipo di strumento per pesare</i>	Genauig- keitsklasse <i>Classe di precisione</i>	EG Bauart- zulassung Nr. <i>N° del Certificato di Approvazione CE*</i>	Prüfschein Nr. Auswertegerät <i>N° del Certificato di prova dell'indicatore</i>
CAI...	TA	SARTOCOMB	III, IIII	T7884	D09-11.02

Elektromechanische Waage

Die Konformitätserklärung gilt, wenn:

- das Auswertegerät als unverändertes Originalmodul verwendet wird. (Diese Erklärung gilt nur für die Waage ohne Zusatzeinrichtungen)
- die Kompatibilität der Module über das zur Verfügung gestellte Programm "KOMPMOD.xls" bestätigt und vom Waagenbauer unterschrieben wurde. Hiermit übernimmt der Waagenbauer die Verantwortung für die Richtigkeit und die Konstruktion.
- eine Benannte Stelle der EU geprüft und in einer Konformitätsbescheinigung bestätigt hat:
 - * die Übereinstimmung der im Formular (Programm) gemachten Angaben mit Waage und EG-Bauartzulassung.
 - * die Richtigkeit der Aufschriften auf dem Kennzeichnungsschild
 - * die Einhaltung der gesetzlichen Vorschriften durch vorhandene Anwendungsprogramme
 - * die Prüfung der Waage nach EN 45501 Punkt 8.2
- die Benannte Stelle das Kennzeichnungsschild mit der grünen Klebemarke mit dem Messtechnik-M und ihrer Nummer ausgerüstet und die in der EG-Bauartzulassung geforderten Stellen mit ihren Sicherungsmarken verschlossen hat.

Strumento per pesare elettromeccanico

La Dichiarazione di Conformità si può applicare se:

- l'indicatore è impiegato come modulo originale inalterato. (Questa dichiarazione concerne solo lo strumento per pesare senza apparecchiature supplementari)
- la compatibilità dei moduli è confermata dal programma fornito "KOMPMOD.xls" e firmata dall'assemblatore della bilancia. Con la presente l'assemblatore della bilancia si assume la responsabilità per la precisione e la costruzione.
- un Organismo Notificato dell'UE ha eseguito il controllo e ha confermato in un proprio Certificato di Conformità quanto segue:
 - * le informazioni e le specifiche contenute nel modulo (programma) sono conformi a quelle dello strumento per pesare e del Certificato di Approvazione CE del Tipo.
 - * le iscrizioni sull'etichetta di identificazione sono corrette
 - * i presenti programmi applicativi soddisfano le disposizioni legali
 - * il controllo dello strumento per pesare è stato eseguito in conformità alla norma EN 45501, paragrafo 8.2
- l'Organismo Notificato ha applicato all'etichetta di identificazione l'adesivo verde con il marchio metrologico «M» e il suo numero di registrazione, e ha sigillato i posti richiesti nel certificato di approvazione CE del tipo con i sigilli di protezione.

Sartorius Weighing Technology GmbH **
37070 Göttingen, Deutschland / Repubblica Federale Tedesca
Göttingen, 16.04.2012

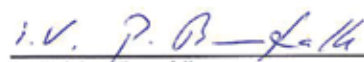
Dr. Reinhard Baumfalk
(Direttore R&D)

J. Rehwald
(Leitung Produktion Mechatronik / Wägetechnik)
(Direttore di produzione delle Divisioni
Meccatronica/Tecnologie di Pesatura)

** Sartorius Weighing Technology GmbH ist Rechtsnachfolgerin der Sartorius AG
**) La società Sartorius Weighing Technology GmbH è la succeditrice legale di Sartorius AG



EC type-approval certificate

Number **T7884** revision 1
Project number 219470
Page 1 of 3

Issued by NMI Certin B.V.
Hugo de Grootplein 1
3314 EG Dordrecht
The Netherlands

In accordance with The Council Directive 2009/23/EC on non-automatic weighing instruments.

Manufacturer Sartorius Weighing Technology GmbH
Weender Landstrasse 94 – 108
37075 Goettingen
Germany

In respect of A class **III** or **III**, electronic, **non-automatic weighing instrument**.
Manufacturer mark/name: Sartorius (Sartorius Weighing Technology GmbH is
the legal successor of Sartorius AG)
Type : SARTOCOMB

Characteristics $n \leq$ the number of verification scale intervals mentioned in the test certificates.
In the description number T7884 revision 1 further characteristics are described.

Valid until 14 February 2021

Description and documentation The instrument is described in the description number T7884 revision 1 and
documented in the test certificates involved.

Remark This revision EC type-approval certificate replaces the earlier version, except for
the documentation folder of the test certificates involved.

The Notified Body no. 0122
NMI Certin, 5 September 2011

C. Dosterman
Head Certification Board

NMI Certin B.V.
Hugo de Grootplein 1
3314 EG Dordrecht
The Netherlands
T +31 78 6332332
certin@nmi.nl
www.nmi.nl

This document is issued under the provision
that no liability is accepted and that the
applicant shall indemnify third-party liability.

The designation of NMI Certin BV. as Notified
Body can be verified at [http://
ec.europa.eu/enterprise/newapproach/nando/](http://ec.europa.eu/enterprise/newapproach/nando/)

Parties concerned can lodge objection
against this decision, within six weeks
after the date of submission, to the
general manager of NMI (see
"Regulation objection and appeal
against decisions of NMI" www.nmi.nl)

Reproduction of the complete
document only is permitted



Physikalisch-Technische Bundesanstalt

Braunschweig und Berlin

PTB**Prüfschein***Test Certificate***Ausgestellt für:***Issued to:*Sartorius Weighing Technology GmbH
Weender Landstr. 94-108
37075 Göttingen**Prüfgrundlage:***In accordance with:*DIN EN 45501 (1992) Nr. 8.1, WELMEC-Leitfaden 2.1 (2001),
Richtlinie 2009/23/EG, OIML R 76-1 (2006)**Gegenstand:***Object:*Auswertegerät *Indicator*
oder Anzeige- und Bedienterminal
*or indicating and operating terminal***Typ:***Type:*

TA

Kennnummer:*Serial No.:***Prüfscheinnummer:***Test Certificate No.:*D09-11.02 1. Revision
D09-11.02 Revision 1**Datum der Prüfung:***Date of test:***Anzahl der Seiten:***Number of pages:*

18

Geschäftszeichen:*Reference No.:*

PTB-1.12-4052216

Benannte Stelle:*Notified Body:*

0102

Im Auftrag*On behalf of PTB*

Braunschweig, 03.08.2011

Im Auftrag*On behalf of PTB***Siegel***Seal*

Timo Schwabe



Dipl.-Ing. M. Link

R3-0025 i

Prüfscheine ohne Unterschrift und Siegel haben keine Gültigkeit. Dieser Prüfschein darf nur unverändert weiterverbreitet werden. Auszüge bedürfen der Genehmigung der Physikalisch-Technischen Bundesanstalt.

Test Certificates without signature and seal are not valid. This Test Certificate may not be reproduced other than in full. Extracts may be taken only with the permission of the Physikalisch-Technische Bundesanstalt.

Plates and Markings

CAI... (Type TA)

- S** Protective mark (self-adhesive mark or seal)
- S*** Protective mark (self-adhesive mark or seal) , only for transferable labels (detachable labels that remain intact after removal)
- S**** Protective mark (self-adhesive mark or seal), only in case of existent ADC
- S***** Protective mark (self-adhesive mark or seal), only in case of existent approved data storage device.
- K** Descriptive plate with CE konformity mark
- M** green metrology sticker
- MD** Metrological data Max, Min, e and if existent d
- T** Plate with model designation

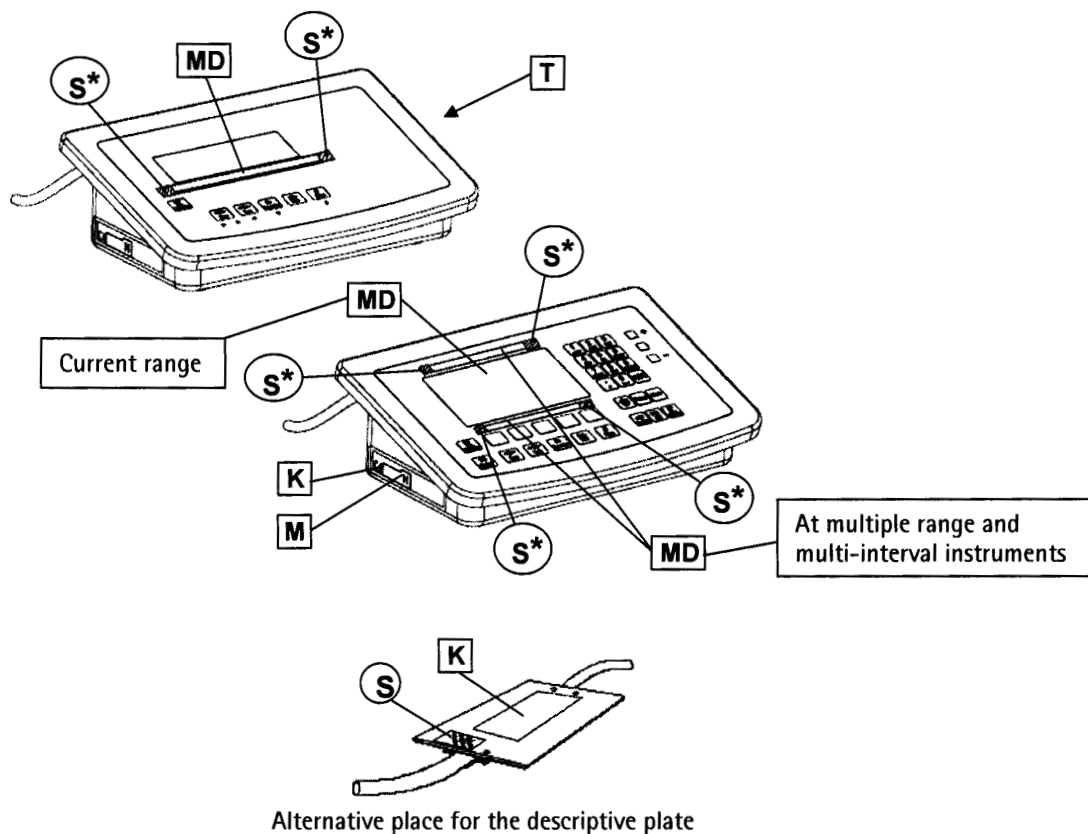

PPTA160111e

Type of weighing instrument: SARTOCOMB + Type of indicator: TA
 EC type-approval certificate T7884 + test certificate D09-11.02

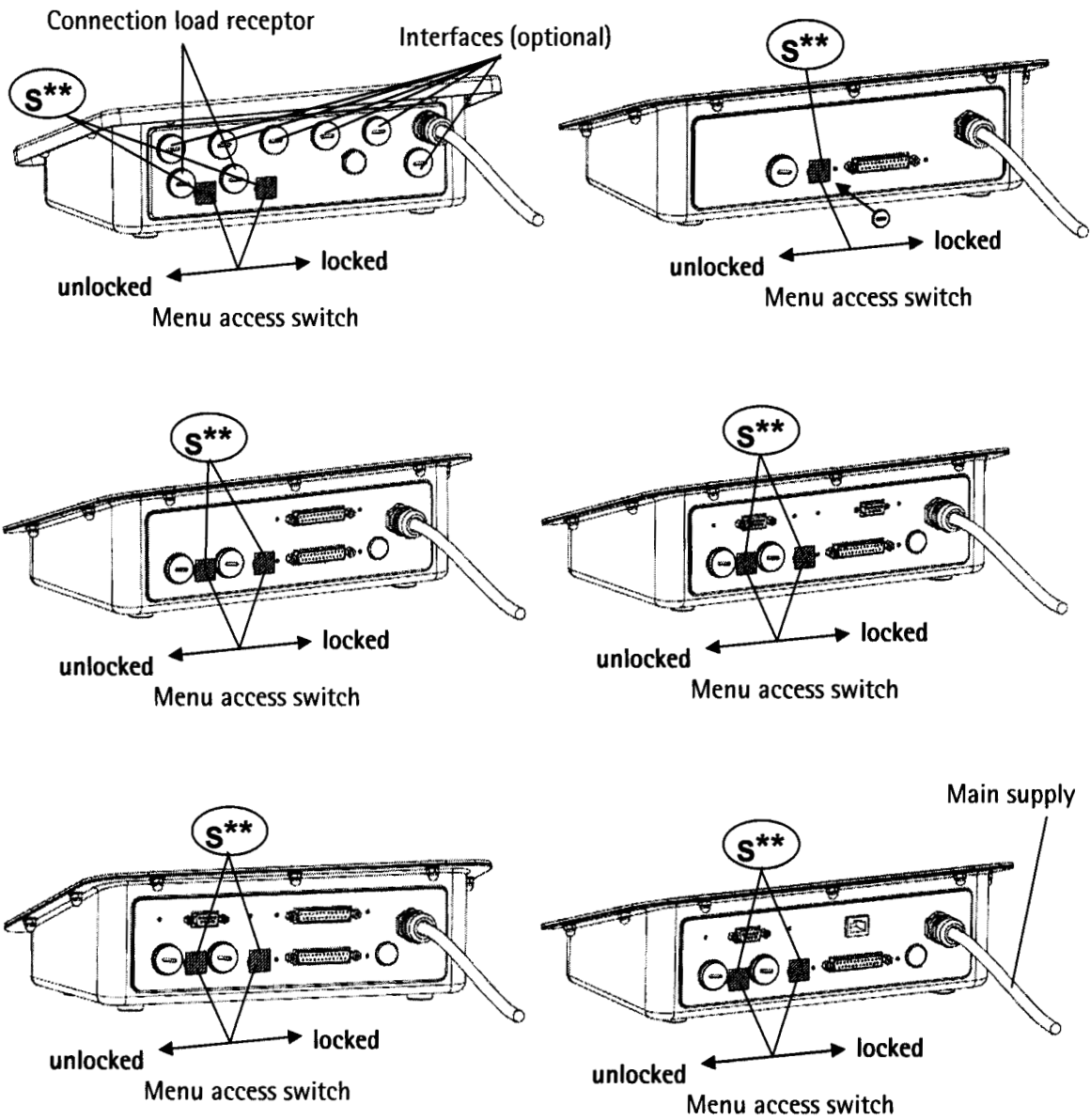

PPTA160111e

Type of weighing instrument: SARTOCOMB + Type of indicator: TA
 EC type-approval certificate T7884 + test certificate D09-11.02

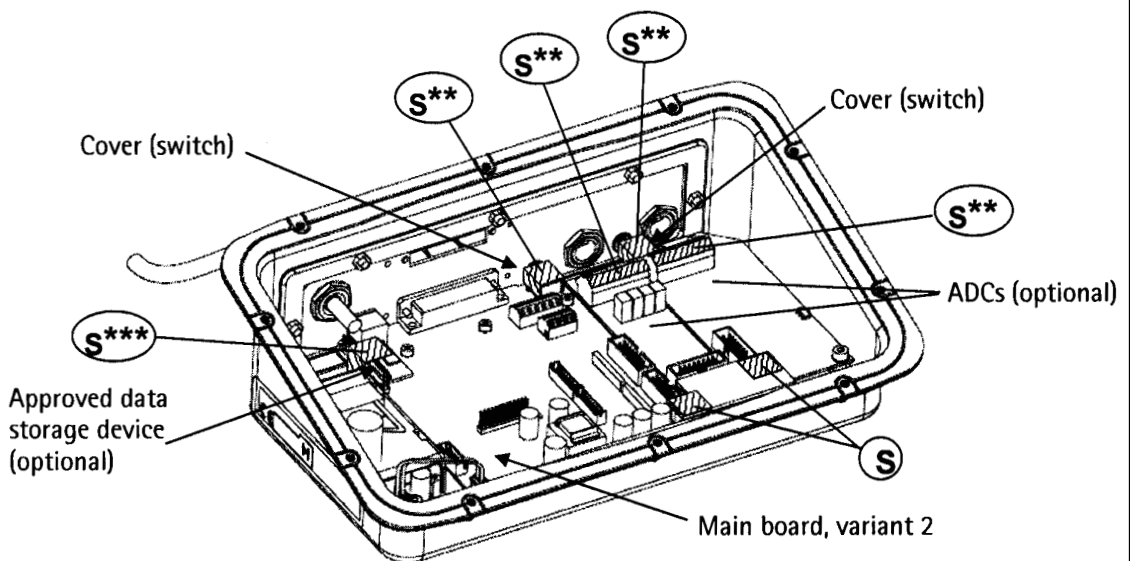
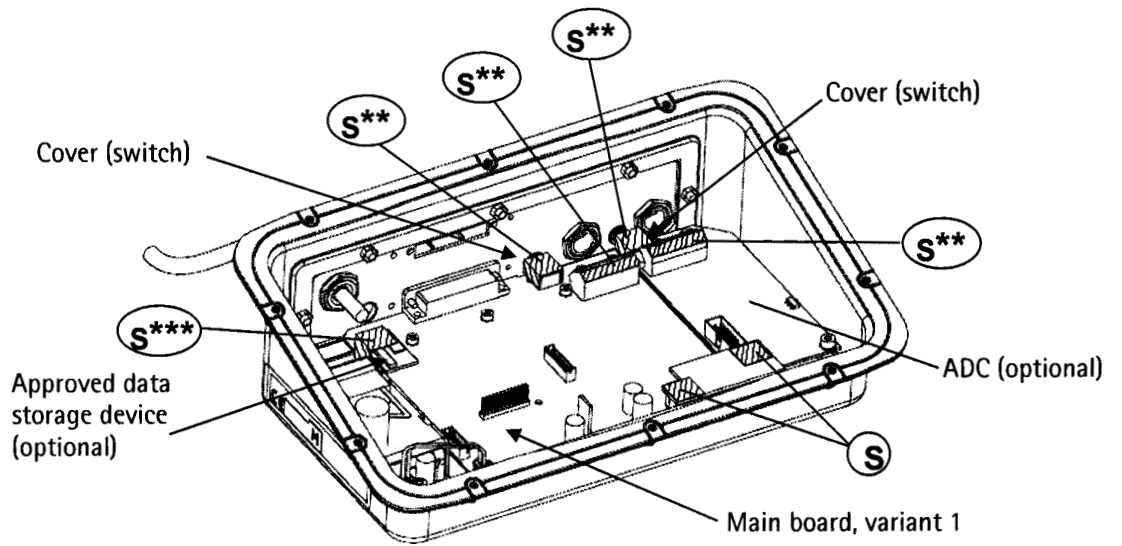

PPTA160111e

Type of weighing instrument: SARTOCOMB + Type of indicator: TA
 EC type-approval certificate T7884 + test certificate D09-11.02

Alternative separable (disconnectable) plug connection between Indicator and load receptor.

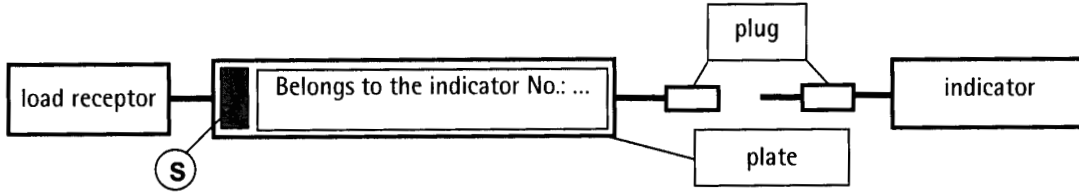

If a junction box is in existence between load receptor with strain-gauge load cells and indicator it has to be secured against inadmissible manipulation.

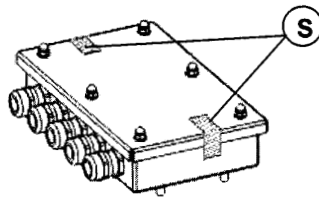

Example of plate with model designation (indicator) T

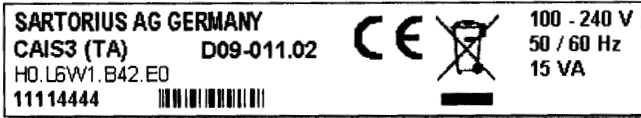

Example of descriptive plate on a weighing instrument already verified K

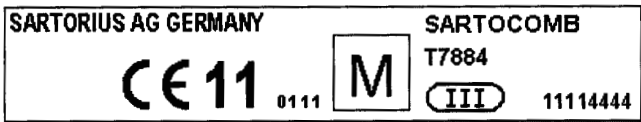

Examples of labels with metrological data MD

One range instrument

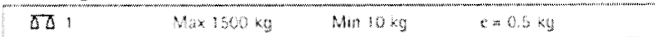

Three ranges instrument

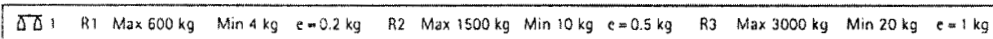

Two-intervals instrument

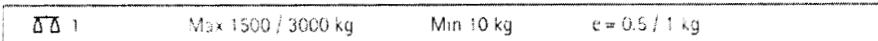

Labels for entering metrological data

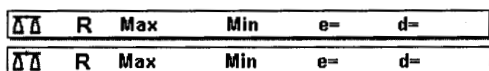

Example:

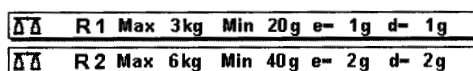

PPTA160111e

Type of weighing instrument: SARTOCOMB + Type of indicator: TA
EC type-approval certificate T7884 + test certificate D09-11.02

Menu Structure

Overview of the complete menu structure; the individual setting parameters are listed on the following pages.

The indicator only displays the menus that correspond to the available hardware.

APPLIC. **Setting and selection applications** (see page 136)

- APPLIC. 1	Basic weighing function, Counting \clubsuit , Neutral measurement \clubsuit , Animal weighing \clubsuit , Weighing in percent % applications
- APPLIC. 2	Checkweighing +/-, Classification \clubsuit applications
- APPLIC. 3	Net-total formulation \clubsuit , Totalizing Σ applications
- AUT. TARE	Automatic taring: first weight tared
- MIN. TARE	Minimum load for automatic tare and printout
- AUT. START	Automatic start of application
- CLEAR.CF	Selective deleting with the \square key
- TARE.FNC	Tare function
- RESET	Factory settings for all applications

FN-KEY Defines functions of the \square key (see page 140)

- OFF	
- 2ND.UNIT	

SETUP Adjusts device settings to user requirements (see page 140)

- WP 1	Settings for weighing platform 1
- COM 1	Settings for the RS-232 interface
- UNICOM	Settings for the 2nd optional interface
- COM-WP	10,000e ADC setting
- CTRL IO	Universal input and digital IOs setting (optional)
- BARCODE	Settings for barcode function
- PRINT	Printout settings
- UTILIT.	Settings for additional functions
- TIME	Time setting
- DATE	Date setting
- U-CODE	User password entry for locking the Setup menu
- S-DATE	Only visible in Service mode; applications
- SER.NO	Only visible in Service mode; serial number
- MODEL	Only visible in Service mode; serial number
- S-SDMIN	Only visible in Service mode;
- SDMIN	Activates display or GMP-compliant printout
- ALIB.MEM	

INFO **Displays device-specific information** (see page 150)

- SERVICE	Service date
- TERM	Indicator serial number
- WP- 1	Weighing platform 1 device data
- WP- 2	Weighing platform 2 device data
- FLEXINF	FlexPrint settings
- ALIB.MEM	Alibi memory settings (optional)

LANGUAG. **Language setting for display and printout** (see page 150)

- DEUTSCH	
- ENGLISH	
- U.S.MODE	
- FRANCO.	
- ITAL.	
- ESPANOL	
- COBES	

ADC.CON **ADC configuration settings** (see page 151)

- VERIF.	
- STANDARD	

Combics 1 application menu

* = Factory setting

<i>APPLIC.</i>	<i>WEIGH.</i>		
	<i>PARAM. 1</i>		
<i>MIN.INIT</i>	Minimum load for automatic taring		3.5
<i>1 DIGIT</i>	1 digit*		3.5.1
<i>2 DIGIT</i>	2 digits		3.5.2
<i>5 DIGIT</i>	5 digits		3.5.3
<i>10 DIGIT.</i>	10 digits		3.5.4
<i>20 DIGIT.</i>	20 digits		3.5.5
<i>50 DIGIT.</i>	50 digits		3.5.6
<i>100 DIG.</i>	100 digits		3.5.7
<i>200 DIG.</i>	200 digits		3.5.8
<i>500 DIG.</i>	500 digits		3.5.9
<i>1000 DI.</i>	1000 digits		3.5.10
<i>AUT.TARE</i>	Automatic taring: first weight tared		3.7
<i>OFF</i>	Off		3.7.1
<i>ON</i>	On		3.7.2
<i>TARE.FNC</i>	Tare function		3.25
<i>NORMAL</i>	Can add a preset tare if tare value is available; however no tare function possible	3.25.1*	
<i>SPECIAL</i>	When a preset tare is entered, the tare value is deleted; however, tare function activation is possible	3.25.2	
<i>RESET</i>	Restore all applications to factory default settings		9.1
<i>YES</i>	Yes (restore factory settings)		9.1.1
<i>NO</i>	No (retain user-defined settings)		9.1.2*

Combics 2 application menu

* = Factory setting

<i>APPLIC./APPLIC. 1</i>	<i>WEIGH.</i>	Weighing	
<i>MIN.INIT</i>	Minimum load for automatic taring		3.5
<i>1 DIGIT</i>	1 digit*		3.5.1
<i>2 DIGIT</i>	2 digits		3.5.2
<i>5 DIGIT</i>	5 digits		3.5.3
<i>10 DIGIT.</i>	10 digits		3.5.4
<i>20 DIGIT.</i>	20 digits		3.5.5
<i>50 DIGIT.</i>	50 digits		3.5.6
<i>100 DIG.</i>	100 digits		3.5.7
<i>200 DIG.</i>	200 digits		3.5.8
<i>500 DIG.</i>	500 digits		3.5.9
<i>1000 DI.</i>	1000 digits		3.5.10
<i>AUT.TARE</i>	Automatic taring: first weight tared		3.7
<i>OFF</i>	Off		3.7.1
<i>ON</i>	On		3.7.2
<i>APPLIC./APPLIC. 1</i>	<i>COUNT.</i>	Counting	
<i>MIN.INIT</i>	Minimum load for application		3.6
<i>1 DIGIT</i>	1 digit		3.6.1*
<i>2 DIGIT</i>	2 digits		3.6.2
	... see "WEIGHING"		
<i>1000 DI.</i>	1000 digits		3.6.10
<i>RESOLUT</i>	Resolution for calculation of reference piece weight		3.9
<i>DISP.ACC</i>	Display accuracy		3.9.1*
<i>10 FOLD</i>	Plus 1 decimal place (10 fold)		3.9.2
<i>100 FOLD</i>	Plus 2 decimal places (100 fold)		3.9.3
<i>SAVE.WT.</i>	Parameter for saving weight values		3.11
<i>STABIL.</i>	With stability		3.11.1*
<i>ACC.STAB</i>	With increased stability		3.11.2
<i>REF.UPDT</i>	Reference sample updating		3.12
<i>OFF</i>	Off		3.12.1
<i>AUTOMAT</i>	Automatic		3.12.2*

<i>REF.WP</i>	Reference weighing instrument	3.13
<i>NO WP</i>	No platform selected	3.13.1*
<i>WP 1</i>	Weighing platform 1	3.13.2
<i>WP 2</i>	Weighing platform 2	3.13.3
<i>APPLIC./APPLIC. 1</i>	NEUTR.M Neutral measurement	
<i>MIN.INIT</i>	Minimum load for application	3.6
<i>1 DIGIT</i>	1 digit	3.6.1*
<i>2 DIGIT</i>	2 digits	3.6.2
	... see "WEIGHING"	
<i>1000 DI.</i>	1000 digits	3.6.10
<i>RESOLUT</i>	Resolution for calculation of reference value	3.9
<i>DISP.ACC</i>	Display accuracy	3.9.1*
<i>10 FOLD</i>	Plus 1 decimal place (10 fold)	3.9.2
<i>100 FOLD</i>	Plus 2 decimal places (100 fold)	3.9.3
<i>DEC.PLCS</i>	Decimal places in displayed result	3.10
<i>NONE</i>	None	3.10.1
<i>1 DEC.PL</i>	1 decimal place	3.10.2
<i>2 DEC.PL</i>	2 decimal places	3.10.3
<i>3 DEC.PL</i>	3 decimal places	3.10.4
<i>SAVE.WT.</i>	Parameter for saving weight values	3.11
<i>STABIL.</i>	With stability	3.11.1*
<i>ACC.STAB</i>	With increased stability	3.11.2
<i>REF.WP</i>	Reference weighing instrument	3.13
<i>NO WP</i>	No platform selected	3.13.1*
<i>WP 1</i>	Weighing platform 1	3.13.2
<i>WP 2</i>	Weighing platform 2	3.13.3
<i>APPLIC./APPLIC. 1</i>	ANIM.WG Animal weighing (averaging)	
<i>MIN.INIT</i>	Minimum load for application	3.6
<i>1 DIGIT</i>	1 digit	3.6.1*
<i>2 DIGIT</i>	2 digits	3.6.2
	... see "WEIGHING"	
<i>1000 DI.</i>	1000 digits	3.6.10
<i>START</i>	Start averaging	3.18
<i>MANUAL</i>	Manual	3.18.1*
<i>AUTOMAT</i>	Automatic	3.18.2
<i>ACTIVITY</i>	Animal activity	3.19
<i>0.1 PERC.</i>	0.1% of the animal/object	3.19.1
<i>0.2 PERC.</i>	0.2% of the animal/object	3.19.2*
<i>0.5 PERC.</i>	0.5% of the animal/object	3.19.3
<i>1 PERC.</i>	1% of the animal/object	3.19.4
<i>2 PERC.</i>	2% of the animal/object	3.19.5
<i>5 PERC.</i>	5% of the animal/object	3.19.6
<i>10 PERC.</i>	10% of the animal/object	3.19.7
<i>20 PERC.</i>	20% of the animal/object	3.19.8
<i>50 PERC.</i>	50% of the animal/object	3.19.9
<i>100 PERC.</i>	100% of the animal/object	3.19.10
<i>PRINT</i>	Autom. printout of results	3.20
<i>MANUAL</i>	Manual	3.20.1*
<i>AUTOMAT</i>	Automatic	3.20.2
<i>DIS.UNL</i>	Static display of result after load removed	3.21
<i>CLEAR</i>	Display is fixed until unload threshold reached	3.21.1*
<i>PRESENT</i>	Fixed display until [CF] is pressed	3.21.2
<i>APPLIC./APPLIC. 1</i>	PERCENT. Weighing in percent	
<i>MIN.INIT</i>	Minimum load for application	3.6
<i>1 DIGIT</i>	1 digit	3.6.1*
<i>2 DIGIT</i>	2 digits	3.6.2
	... see "WEIGHING"	
<i>1000 DI.</i>	1000 digits	3.6.10
<i>RESOLUT</i>	Resolution for calculation of reference value	3.9
<i>DISP.ACC</i>	Display accuracy	3.9.1*
<i>10 FOLD</i>	Plus 1 decimal place (10 fold)	3.9.2
<i>100 FOLD</i>	Plus 2 decimal places (100 fold)	3.9.3

<i>DEC.PLCS</i>	Decimal places in displayed result	3.10
<i>NONE</i>	None	3.10.1
<i>1 DEC.PL</i>	1 decimal place	3.10.2
<i>2 DEC.PL</i>	2 decimal places	3.10.3
<i>3 DEC.PL</i>	3 decimal places	3.10.4
<i>SAVE.WT.</i>	Parameter for saving weight values	3.11
<i>STABIL.</i>	With stability	3.11.1*
<i>ACC.STAB</i>	With increased stability	3.11.2
<i>REF.WP</i>	Reference weighing instrument	3.13
<i>NOWP</i>	No platform selected	3.13.1*
<i>WP 1</i>	Weighing platform 1	3.13.2
<i>WP 2</i>	Weighing platform 2	3.13.3
<i>CALC.DIS</i>	Display of calculated value	3.15
<i>RESID.GT</i>	Residue	3.15.1*
<i>LOSS</i>	Calculation	3.15.2
<i>APPLIC./APPLIC.2</i>	<i>OFF</i>	
<i>APPLIC./APPLIC.2</i>	CHECK.WG Checkweighing	
<i>CHECK.RG</i>	Checkweighing range	4.2
<i>30-170%</i>	30 to 170%	4.2.1*
<i>10-MAX.L</i>	10% to infinity	4.2.2
<i>CTRL.SET</i>	Activate SET control output	4.3
<i>OUTPUT</i>	SET output	4.3.1*
<i>OP.READY</i>	Ready to operate (for process control systems)	4.3.2
<i>OUTP.ACT</i>	Activation of outputs	4.4
<i>OFF</i>	Off	4.4.1
<i>ALWAY.ON</i>	Always	4.4.2
<i>STABIL.</i>	On at stability	4.4.3
<i>CHECK.RG</i>	On within checkweighing range	4.4.4*
<i>STAB.CHK</i>	On at stability within checkweighing range	4.4.5
<i>INPUT</i>	Parameter input	4.5
<i>TAR.MIN.MX</i>	Min, Max, target value	4.5.1*
<i>TARG.PER</i>	Only target value with percent limits	4.5.2
<i>TAR.A.PER</i>	Target value with asymmetrical percent limits	4.5.3
<i>TAR.TOL.</i>	Target value with relative tolerances	4.5.4
<i>AUT.PRNT</i>	Automatic printing	4.6
<i>OFF</i>	Off	4.6.1*
<i>ON</i>	On	4.6.2
<i>OK</i>	Only values within tolerance	4.6.3
<i>NOT OK</i>	Only values outside tolerance	4.6.4
<i>APP.ZERO</i>	Checkweighing toward zero	4.7
<i>OFF</i>	Off	4.7.1*
<i>ON</i>	On (☒ symbol is displayed)	4.7.2
<i>APPLIC./APPLIC.2</i>	CLASS. Classification	
<i>PARAM.1</i>	Parameter 1	
<i>MIN.INIT</i>	Minimum load for application	3.6
<i>1 DIGIT</i>	1 digit	3.6.1*
<i>2 DIGIT</i>	2 digits	3.6.2
	... see "WEIGHING"	
<i>1000 DI.</i>	1000 digits	3.6.10
<i>PARAM.2</i>	Parameter 2	
<i>CTRL.SET</i>	Activate SET control output	4.3
<i>OUTPUT</i>	SET output	4.3.1*
<i>OP.READY</i>	Ready to operate (for process control systems)	4.3.2
<i>OUTP.ACT</i>	Activation of outputs	4.7
<i>OFF</i>	Off	4.7.1
<i>ALWAY.ON</i>	Always	4.7.2
<i>STABIL.</i>	On at stability	4.7.3*
<i>NUMBER</i>	Number of classes	4.8
<i>3 CLASS</i>	3 classes	4.8.1*
<i>5 CLASS</i>	5 classes	4.8.2
<i>INPUT</i>	Parameter input	4.9
<i>WEIGHTS</i>	Weight values	4.9.1*
<i>PERC.TAG</i>	Percentage	4.9.2

	<i>PRINT</i> Automatic Printing		4.10
	<i>MANUAL</i> Manual		4.10.1*
	<i>AUTOMAT</i> Automatic		4.10.2
<i>APPLIC.3</i>	<i>OFF</i>		
<i>APPLIC./APPLIC.3</i>	<i>NET.TOT.</i> Net total formulation		
	<i>MIN.INIT</i> Minimum load for application		3.6
	<i>1 DIGIT</i> 1 digit		3.6.1*
	<i>2 DIGIT</i> 2 digits		3.6.2
	... see "WEIGHING"		
	<i>1000 DI.</i> 1000 digits		3.6.10
	<i>PRT.SAV.</i> Individual/Component printout when saved		3.17
	<i>OFF</i> Automatic printing off		3.17.1
	<i>EACH.TIM.</i> Print the entire standard print configuration every time		
	when the (OK) key is pressed		3.17.2*
	<i>ONCE</i> Print the entire standard print configuration once with the (OK) key		3.17.3
<i>APPLIC./APPLIC.3</i>	<i>TOTAL</i> Totalizing		
	<i>MIN.INIT</i> Minimum load for application		3.6
	<i>1 DIGIT</i> 1 digit		3.6.1*
	<i>2 DIGIT</i> 2 digits		3.6.2
	... see "WEIGHING"		
	<i>1000 DI.</i> 1000 digits		3.6.10
	<i>AUTO.SAV</i> Autosave		3.16
	<i>OFF</i> Off		3.16.1*
	<i>ON</i> On		3.16.2
	<i>PRT.SAV.</i> Individual/Component printout when saved		3.17
	<i>OFF</i> Automatic printing off		3.17.1
	<i>EACH.TIM.</i> Print the entire standard print configuration every time		
	when the (OK) key is pressed		3.17.2*
	<i>ONCE</i> Print the entire standard print configuration once with the (OK) key		3.17.3
	<i>VAL.FROM</i> Value source for automatic saving		3.22
	<i>APPL. 1</i> Application 1		3.22.1*
	<i>APPL. 2</i> Application 2		3.22.2
	<i>SAV.VAL.</i> Save value		3.23
	<i>NET</i> Net		3.23.1*
	<i>CALCUL.</i> Calculated		3.23.2
	<i>NET+CAL</i> Net and Calculated		3.23.3
<i>APPLICATION / AUT.TARE</i>	Automatic Taring		
	<i>AUT.TARE</i> 1st weight tared		3.7
	<i>OFF</i> Off		3.7.1*
	<i>ON</i> On		3.7.2
<i>APPLICATION / MIN.TARE</i>	Minimum load for automatic taring and automatic printing		
	<i>MIN.TARE</i> Minimum load for automatic taring and automatic printing		3.5
	<i>1 DIGIT</i> 1 digit		3.5.1*
	<i>2 DIGIT</i> 2 digits		3.5.2
	... see "WEIGHING"		
	<i>1000 DI.</i> 1000 digits		3.5.10
<i>APPLICATION / AUT.START</i>	For "On" automatic start of application with the last saved initialization data		
	<i>AUT.START</i> Automatic start of application with last settings		3.8
	<i>AUTOMAT</i> Automatic (on)		3.8.1*
	<i>MANUAL</i> Manual (off)		3.8.2
<i>APPLIC./CLER.CF</i>	Selective deleting with the (CF) key		
	<i>CLER.CF</i> Selective deleting with the (CF) key		3.24
	<i>ALL.APPL</i> Deletes all applications		3.24.1*
	<i>SEL.APPL</i> Only deletes selected application		3.24.2
<i>APPLIC./TARE.FNC</i>	Tare function		
	<i>TARE.FNC</i> Tare function settings		3.25
	<i>NORMAL</i> Can add a preset tare if tare value is available;		
	however, no tare function possible		3.25.1*
	<i>SPECIAL</i> When a preset tare is entered, the tare value is deleted;		
	however, tare function activation is possible		3.25.2

<i>APPLIC. / RESET</i>	Resets all applications to factory settings	
	<i>RESET</i> Restore all applications to factory default settings	9.1
	<i>YES</i> Yes (restore factory settings)	9.1.1
	<i>NO</i> No (retain user-defined settings)	9.1.2*

Menu key assignment for the key * = Factory setting

Combics 2: *FN-KEY*

<i>2ND UNIT</i>	Display 2nd weight unit*
<i>OFF</i>	 key not assigned

Combics 1: *FN-KEY*

<i>GROSS NET</i>	Toggles between the gross or net value
<i>2ND UNIT</i>	Display 2nd weight unit*
<i>RES.X 10</i>	10-fold higher resolution
<i>OFF</i>	 key not assigned*

Setup menu (device settings) * = Factory setting

SETUP / WP-1 / RS-232

SETUP / WP-1 / RS-485

SETUP / WP-1 / INTERN. PARAM. 1

<i>AMBIENT</i>	Adapting the scale to ambient conditions (filter adjustment)	1.1
<i>V.STABLE</i>	Very stable	1.1.1
<i>STABLE</i>	Stable	1.1.2*
<i>UNSTABL</i>	Unstable	1.1.3
<i>V.UNSTABL</i>	Very unstable	1.1.4
<i>APP.FILT</i>	Application filter	1.2
<i>FINAL RD</i>	Final readout	1.2.1*
<i>FILLING</i>	Filling mode	1.2.2
<i>REDUC.</i>	Low filtering	1.2.3
<i>OFF</i>	Without filtering	1.2.4
<i>STAB.RNG</i>	Stability range	1.3
<i>MAX.ACC.</i>	Maximum accuracy (1/4 digit)	1.3.1*
<i>V.ACC.</i>	Very accurate (1/2 digit)	1.3.2
<i>ACC.</i>	Accurate (1 digit)	1.3.3
<i>FAST</i>	Fast (2 digits)	1.3.4
<i>V.FAST</i>	Very fast (4 digits)	1.3.5
<i>MAX.FAST</i>	Maximum fast (8 digits)	1.3.6
<i>STAB.DLY</i>	Stability delay	1.4
<i>NO</i>	No delay	1.4.1
<i>SHORT</i>	Short delay	1.4.2*
<i>AVERAG.</i>	Average delay	1.4.3
<i>LONG</i>	Long delay	1.4.4
<i>TARA</i>	Stability	1.5
<i>W/O STAB</i>	Without stability	1.5.1
<i>W/ STAB</i>	At stability	1.5.2*
<i>AUT.ZERO</i>	Auto zero	1.6
<i>ON</i>	On	1.6.1*
<i>OFF</i>	Off	1.6.2
<i>WGT UNIT</i>	Weight unit (depends on the weighing platform type)	1.7
	¹⁾ not for use in legal metrology	
<i>GRAMS</i>	Grams /g	1.7.2*
<i>KILBGR.</i>	Kilograms /kg	1.7.3
<i>CARATS</i>	Carats/ct ¹⁾	1.7.4
<i>POUNDS</i>	Pounds/lb ¹⁾	1.7.5
<i>OUNCES</i>	Ounces/oz ¹⁾	1.7.6
<i>TROY.OZ.</i>	Troy ounces/oz ¹⁾	1.7.7
<i>HK TAEL</i>	Hong Kong taels/tlh ¹⁾	1.7.8
<i>SNG.TAEL</i>	Singapore taels/tls ¹⁾	1.7.9
<i>TWN.TAEL</i>	Taiwan taels/tlt ¹⁾	1.7.10
<i>GRAINS</i>	Grains/GN ¹⁾	1.7.11
<i>PENNY.WT.</i>	Pennyweights/dwt ¹⁾	1.7.12
<i>MILLIGR.</i>	Milligrams/mg ¹⁾	1.7.13
<i>PT.P.LB</i>	Parts per pound/lb ¹⁾	1.7.14
<i>CHN.TAEL</i>	Chinese taels/tlc ¹⁾	1.7.15
<i>MOMMES</i>	Mommes/mom ¹⁾	1.7.16

	<i>AUSTR.CT</i>	Austrian carats/K ¹⁾	1.7.17
	<i>TOLA</i>	Tola/tol ¹⁾	1.7.18
	<i>BAHT</i>	Baht/bat ¹⁾	1.7.19
	<i>MESGHAL</i>	Mesghal/MS ¹⁾	1.7.20
	<i>TONS</i>	Tons/t	1.7.21
<i>DIS.DIG.</i>	Display accuracy		1.8
	<i>ALL</i>	Show all decimal places	1.8.1*
	<i>-1.DT.CHA</i>	Reduced by 1 digit	1.8.2
	<i>RES.%10</i>	10-fold increased resolution	1.8.14
	<i>+DIV.2</i>	Increase resolution by 2 scale intervals	1.8.15
	<i>+DIV.1</i>	Increase resolution by 1 scale interval	1.8.16
<i>CAL./ADJ.</i>	Calibration, adjustment		1.9
	<i>CAL.EXT.</i>	External calibration/adjustment with default weight	1.9.1*
	<i>CAL.E.AUT.</i>	External cal./adjustment, weight is detected (s. 1.18.1)	1.9.2
	<i>CAL.E.USR.</i>	External calibr./adjustment with user-defined weight	1.9.3
	<i>CAL.INT.</i>	Internal calibr./adjustment (for IS scales only)	1.9.4
	<i>LINE.INT.</i>	Internal linearization (for IS scales only)	1.9.5 ¹⁾
	<i>LINE.EXT.</i>	External linearization with default weights	1.9.6 ¹⁾
	<i>LINE.USR.</i>	External linearization with user-defined weights	1.9.7 ¹⁾
	<i>SET.PREL.</i>	Setting the preload	1.9.8
	<i>DEL.PREL.</i>	Clearing the preload	1.9.9
	<i>BLOCKED</i>	Key locked	1.9.10
<i>CAL.SEQ.</i>	Calibration/Adjustment sequence		1.10
	<i>AUTOMAT</i>	Calibration with automatic adjustment	1.10.1
	<i>MANUAL</i>	Calibration with manual adjustment	1.10.2*
<i>ZERORNG.</i>	Zero range		1.11
	<i>1PERC.</i>	1 percent/max. load	1.11.1
	<i>2PERC.</i>	2 percent/max. load	1.11.2
	<i>5PERC.</i>	5 percent/max. load	1.11.3*
<i>INIT.ZER.</i>	Zero at Power On		1.12
	<i>1PERC.</i>	1 percent/max. load	1.12.1*
	<i>2PERC.</i>	2 percent/max. load	1.12.2
	<i>5PERC.</i>	5 percent/max. load	1.12.3
<i>ONTARE</i>	Tare/zero at Power On		1.13
	<i>ON</i>	On	1.13.1*
	<i>OFF</i>	Off	1.13.2
<i>PP.P.</i>	Calibration prompt		1.15
	<i>OFF</i>	Off	1.15.1*
	<i>ADJ.PROM</i>	On	1.15.2
<i>CAL.EXT</i>	External calibration/adjustment		1.16
	<i>ACTIVAT</i>	Activated	1.16.1*
	<i>DEACT.</i>	Deactivated	1.16.2
<i>CAL.UNIT</i>	Weight unit for calibration		1.17
	<i>GRAMS</i>	Gram	1.17.1*
	<i>KILOGR.</i>	Kilogram	1.17.2
	<i>TONS</i>	Ton	1.17.3
	<i>POUNDS</i>	Pound	1.17.4
<i>MAN.EXT.W</i>	Manual entry of external weights		1.18
	<i>CAL./ADJ.</i>	Cal/Adj. weight	1.18.1
	<i>LINE.WT.1</i>	Linearization weight 1	1.18.2 ¹⁾
	<i>LINE.WT.2</i>	Linearization weight 2	1.18.3 ¹⁾
	<i>LINE.WT.3</i>	Linearization weight 3	1.18.4 ¹⁾
	<i>LINE.WT.4</i>	Linearization weight 4	1.18.5 ¹⁾
<i>ADJ.W/O.W</i>	Adjustment without weights ¹⁾		1.19
	<i>NOM.LOAD</i>	Nominal load	1.19.1
	<i>RESOLUT</i>	Resolution	1.19.2
	<i>SENSIT.1</i>	Sensitivity 1	1.19.3
	<i>SENSIT.2</i>	Sensitivity 2	1.19.4
	<i>SENSIT.3</i>	Sensitivity 3	1.19.5
	<i>SENSIT.4</i>	Sensitivity 4	1.19.6
	<i>ZER.POIN</i>	Zero point	1.19.7
	<i>SAVE</i>	Save parameters	1.19.8
<i>GEOG.DAT</i>	Geographical data ¹⁾		1.20
	<i>LATITUD</i>	Latitude	1.20.1
	<i>ALTIUD</i>	Altitude	1.20.2
	<i>GRAVITY</i>	Gravitational acceleration	1.20.3
	<i>SAVE</i>	Save parameters	1.20.4

¹⁾ Only in Service mode

SETUP / WP- 1 / INTERN.	PARAM.2		
	2.WT.UNIT	2nd weight unit (depends on the weighing platform type)	3.1
		¹⁾ not for use in legal metrology	
	GRAMS	Grams /g	3.1.2*
	KILOGR.	Kilograms /kg	3.1.3
	CARATS	Carats/ct	3.1.4
	POUNDS	Pounds/lb ¹⁾	3.1.5
	OUNCES	Ounces/oz ¹⁾	3.1.6
	TROY.OZ.	Troy ounces/oz ¹⁾	3.1.7
	HK.TAEL	Hong Kong taels/tlh ¹⁾	3.1.8
	SNG.TAEL	Singapore taels/tls ¹⁾	3.1.9
	TWN.TAEL	Taiwan taels/tlt ¹⁾	3.1.10
	GRAINS	Grains/GN ¹⁾	3.1.11
	PENNY.WT.	Pennyweights/dwt ¹⁾	3.1.12
	MILLIGR.	Milligrams/mg ¹⁾	3.1.13
	PT.P.LB	Parts per pound/lb ¹⁾	3.1.14
	CHN.TAEL	Chinese taels/tlc ¹⁾	3.1.15
	MMMMES	Mommes/mom ¹⁾	3.1.16
	AUSTR.CT	Austrian carats/K ¹⁾	3.1.17
	TOLA	Tola/tol ¹⁾	3.1.18
	BAHT	Baht/bat ¹⁾	3.1.19
	MESGHAL	Mesghal/MS ¹⁾	3.1.20
	TONS	Tons/t	3.1.21
	2.DIS.DIG.	Display accuracy	3.2
	ALL	Show all decimal places	3.2.1*
	-1.WT.CHA	Reduced by 1 digit when load changes	3.2.2
	RES.% 10	10-fold increased resolution	3.2.14
	+DIV. 2	Increase resolution by 2 scale intervals	3.2.15
	+DIV. 1	Increase resolution by 1 scale interval	3.2.16
SETUP / WP- 1 / INTERN.	RESET	Factory settings	
	WT.PARA	Restore factory default settings	9.1
	NO	No	9.1.1*
	YES	Yes	9.1.2
SETUP / WP- 1 / INTERN.	ADC-CON	Analog/Digital Converter configuration (ADC) ¹⁾	
	STANDBY	Standard	
	VERIF.	Verifiable	
SETUP / WP- 1 / OFF ²⁾			
SETUP / WP- 1 / COM 1			
SETUP / WP- 1 / UNICOM ³⁾			
	RS-232	RS-232* menu parameters depending on the connected complete scale	
	RS-485	RS-485 menu parameters depending on the connected complete scale	
SETUP / WP- 1 / COM-WP ²⁾			
	RS-232	RS-232* menu parameters depending on the connected complete scale	
	RS-485	RS-485 menu parameters depending on the connected complete scale	
SETUP / COM- 1	OFF		
SETUP / COM- 1	WP-2	Weighing platform 2 ²⁾	
	RS-232*		
		SBI standard	
		SBI trade version (for legal metrology)	
		XBPI-232	
		Menus 1.1 to 1.8 same as for WP1	
		Calibration/Adjustment	1.9
		Ext. calibration/adjustment; default weight*	1.9.1
		External calibration/adjustment; weight can be selected (1.18.1)	1.9.3
		Internal cal./adj.	1.9.4
		No function when you press the  key	1.9.10
		Menus 1.10 to 9.1 same as for WP1	
		ADC-232	
		Menus 1.1 to 9.1 same as for WP1	
		¹⁾ Only in Service mode	
		²⁾ Combics 2 only	
		³⁾ only when Unicom is equipped	

SETUP / COM-1 DAT.PROT. Data protocols

CONFIG.	SBI*		
BAUD	Baud rate		5.1
		150	5.1.1
		300	5.1.2
		600	5.1.3
		1200	5.1.4
		2400	5.1.5
		4800	5.1.6
		9600	5.1.7*
		19200	5.1.8
PARITY	Parity		5.2
		SPACE	Space
			Only if 7 data bits is selected
		ODD	5.2.2
		EVEN	5.2.3*
		EVEN	5.2.4
		NONE	5.2.5
STOPBIT	Number of stop bits		5.3
		1STOP	5.3.1*
		2STOP	5.3.2
HANDSHK	Handshake mode		5.4
		SOFTW.	5.4.1
		HARDW.	Software handshake
			Hardware handshake,
			1 character after CTS
			5.4.3*
DATABIT	Number of data bits		5.6
			7 bits*
			5.6.1
			8 bits
			5.6.2
MAN./AUT.	Data output (manual/automatic)		6.1
		IND.W/O	6.1.1
		IND.AFTR	6.1.2*
		AUT.W/O	6.1.4
		AUT.WITH	6.1.5
		PROT.PRN	6.1.7
			Manual without stability
			Manual after stability
			Automatic without stability
			Automatic with stability
			Protocol printout for computer (PC)
AUT.CYCL	Time-dependent automatic data output		6.3
		ERCHVAL	6.3.1*
		AFTER 2	6.3.2
		AFTER 10	6.3.4
		AFTER 100	6.3.7
			1 display update
			2 display updates
			10 display updates
			100 display updates
LINE	Data output: line format		7.2
		16 CHAR	7.2.1
		22 CHAR	For raw data: 16 characters
			For other applications:
			22 characters 7.2.2*
SIGN	Data output: sign format		7.3
		+ DEACT.	7.3.1
		+ ACTIV.	7.3.2*
			Plus sign deactivated
			Plus sign activated
SETTING	Factory settings for COM1: SB		9.1
		YES	9.1.1
		NO	9.1.2
			Yes
			No*
XBPI-232			
SMA			
BAUD	Baud rate		5.1
		150	5.1.1
		300	5.1.2
		600	5.1.3
		1200	5.1.4
		2400	5.1.5
		4800	5.1.6
		9600	5.1.7*
		19200	5.1.8

Numeric menu 5.2 to 5.6 similar to SBI

SETUP / COM-1 PRINTER Printer configuration

YDP20

CONFIG.

<i>BAUD</i> Baud rate			5.1
	<i>1200</i>	1200	5.1.4*
	<i>2400</i>	2400	5.1.5
	<i>4800</i>	4800	5.1.6
	<i>9600</i>	9600	5.1.7
	<i>19200</i>	19200	5.1.8
<i>PARITY</i> Parity			5.2
	<i>SPACE</i>	Space	
		Only if 7 data bits is selected	5.2.2
	<i>ODD</i>	Odd	5.2.3*
	<i>EVEN</i>	Even	5.2.4
	<i>NONE</i>	None	5.2.5
<i>STOPBIT</i> Number of stop bits			5.3
	<i>1STOP</i>	1 stop bit	5.3.1*
	<i>2STOP</i>	2 stop bits	5.3.2
<i>HANDSHK</i> Handshake mode			5.4
	<i>SOFTW.</i>	Software handshake	5.4.1
	<i>HARDW.</i>	Hardware handshake, 1 character after CTS	5.4.3*
YDP14IS			
	<i>LINE</i>	Strip printer*	
	<i>LABEL</i>	Label printer	

Universal printer

CONFIG.

<i>BAUD</i> Baud rate			5.1
	<i>150</i>	150	5.1.1
	<i>300</i>	300	5.1.2
	<i>600</i>	600	5.1.3
	<i>1200</i>	1200	5.1.4
	<i>2400</i>	2400	5.1.5
	<i>4800</i>	4800	5.1.6
	<i>9600</i>	9600	5.1.7*
	<i>19200</i>	19200	5.1.8
<i>PARITY</i> Parity			5.2
	<i>SPACE</i>	Space	
		Only if 7 data bits is selected	5.2.2
	<i>ODD</i>	Odd	5.2.3*
	<i>EVEN</i>	Even	5.2.4
	<i>NONE</i>	None	5.2.5
<i>STOPBIT</i> Number of stop bits			5.3
	<i>1STOP</i>	1 stop bit	5.3.1*
	<i>2STOP</i>	2 stop bits	5.3.2
<i>HANDSHK</i> Handshake mode			5.4
	<i>SOFTW.</i>	Software handshake	5.4.1
	<i>HARDW.</i>	Hardware handshake, 1 character after CTS	5.4.3*
<i>DATABIT</i> Number of data bits			5.6
		7 bits	5.6.1*
		8 bits	5.6.2
YDP04IS*			
	<i>LINE</i>	Strip printer*	
	<i>LABEL</i>	Label printer	
	<i>LABFF</i>	Label printer with manual feed	

SETUP / UNICOM OFF*

WP-2 Weighing platform 2 (Combics 2 only)

RS-232

SBI standard

SBI trade version (for legal metrology)

XBPI-232*

Menus 1.1 to 1.8 same as for WP1

Calibration/Adjustment 1.9

Ext. calibration/adjustment; default weight 1.9.1*

External calibration/adjustment;
weight can be selected (1.18.1) 1.9.3

Internal cal./adj. 1.9.4

No function when you press the  key 1.9.10

Menus 1.10 to 9.1 same as for WP1

ADC-232

Menus 1.1 to 9.1 same as for WP1

RS-485*

IS-485 Connect Sartorius IS weighing platform

Menus 1.1 to 1.8 same as for WP1

Calibration/Adjustment 1.9

Ext. calibration/adjustment; default weight 1.9.1*

External calibration/adjustment;
weight can be selected (1.18.1) 1.9.3

Internal cal./adj. 1.9.4

No function when you press the  key 1.9.10

Menus 1.10 to 9.1 same as for WP1

ADC-485

Menus 1.1 to 9.1 same as for IS-485

DAT.PROT. Data protocol

SBI SBI standard version*

Menus 5.1 to 9.1 same as for COM1

*XBPI-232 XBPI-232

*XBPI-485 XBPI-485

0 to 31 Network address: selectable from 0 to 31

SMA SMA interface function

Menus 5.1 to 5.6 same as for COM1

PROFIBUS XBPI-485

Address 0 to 126 Addresses 0 to 126 can be selected

App/Dat

NO No*

YES Yes, transfer application data

ETHER Ethernet

SRC.IP Source IP: 192.168.0.1*

SRC.NAME Source name (max. 16 characters)

LIS.PORT List port: 49155

SUBNET Subnet mask: 255.255.255.0

GATEW.IP Gate IP: 0.0.0.0*

DEST.IP Destination IP: 0.0.0.0*

DEST.POR Destination port: 49155*

PROTOD. Protocol

TCP*

UDP

MODE

SBI-SRV (server)

Data output (manual/automatic) 6.1

Manual without stability 6.1.1

Manual after stability 6.1.2*

Protocol printout 6.1.7

Data output: line format 7.2

For raw data: 16 characters 7.2.1

For other applications:

22 characters 7.2.1*

Data output: sign format 7.3

Plus sign deactivated 7.3.1

Plus sign activated 7.3.2*

SBI-C/S (client)

Data output (manual/automatic) 6.1

Manual without stability 6.1.1

Manual after stability* 6.1.2

Automatic without stability 6.1.4

Automatic with stability 6.1.5

























Protocol printout for
computer (PC) 6.1.7

	Time-dependent automatic data output	6.3
	1 display update	6.3.1*
	2 display updates	6.3.2
	10 display updates	6.3.4
	100 display updates	6.3.7
	Data output: line format	7.2
	For raw data: 16 characters	7.2.1
	For other applications: 22 characters	7.2.2*
	Data output: sign format	7.3
	Plus sign deactivated	7.3.1
	Plus sign activated	7.3.2*
	XBPI	
	SMA	
	Modbus/TCP	
<i>PRINTER</i>	Printer configuration	
<i>YDP20</i>	YDP20	
	Menus 5.1 to 5.4 same as for COM1	
<i>YDP14IS</i>	YDP14IS	
	<i>LINE</i> Strip printer*	
	<i>LABEL</i> Label printer	
<i>UNI-PRI</i>	Universal printer	
	Menus 5.1 to 5.6 same as for COM1	
<i>YDP04IS*</i>	YDP04IS	
	<i>LINE</i> Strip printer*	
	<i>LABEL</i> Label printer	
	<i>LABFF</i> Label printer with manual feed	
<i>ANALOG</i>	Analog data output port for PLC operation	
	Analog output: value	8.12
	<i>NET</i> Net value*	8.12.1
	<i>GROSS</i> Gross value	8.12.2
	Analog output: error indicator	8.13
	<i>HIGH</i> High level (20 mA)*	8.13.1
	<i>LOW</i> Low level (0/4 mA) when menu is open or during calibration: 0/4 mA on this interface	8.13.2
	Analog output: mode	8.14
	<i>0-MAX.L.</i> Zero to maximum load*	8.14.1
	<i>MIN./MAX</i> Minimum/Maximum values	8.14.2
	Analog output: data output min./max.	8.15
	<i>MIN</i> Min. (0/4 mA) input in kg	8.15.1
	<i>MAX</i> Max. (20 mA) input in kg	8.15.2
	Analog output: output value comparison	8.16
	<i>4MA</i> 4 mA measured value entry	8.16.1
	<i>20MA</i> 20 mA measured value entry	8.16.2
<i>SETUP / COM-WP</i>	Optional: multiple scale connection (Combics 2 only)	
	<i>OFF*</i>	
	<i>WP-2</i> Weighing platform 2	
	see <i>UNICOM / WP-2</i>	

SETUP / CTRL IO

INPUT

PARAMET

EXT.KEY	Function for external key	8.4
PRINT	Trigger  key function*	8.4.1
PRINT.LNG.	Trigger  key function (press and hold)	8.4.2
TARE	Trigger  key function	8.4.3
ISO.TEST	Trigger  key function	8.4.4
FN	Trigger  key function	8.4.5
SCALE.NO.	Trigger  key function	8.4.6
OK	Trigger  key function	8.4.7
Z/TARE	Combined zero/tare function	8.4.8
ZERO	Trigger  key function	8.4.9
ON.STBY	Trigger  key function	8.4.10
CF	Trigger  key function (Combics 2 only)	8.4.11
INFO	Trigger  key function (Combics 2 only)	8.4.12
(-)-	Trigger  key function (Combics 2 only)	8.4.13
X10	Trigger  key function (Combics 2 only)	8.4.14
B/G NET	Trigger  key function (Combics 2 only)	8.4.15
1.EXTERNAL	External control input 1	8.17
PRINT	Trigger  key function*	8.17.1
	... see 8.4	
B/G NET	Trigger  key function (Combics 2 only)	8.17.15
2.EXTERNAL	External control input 2	8.18
PRINT	Trigger  key function*	8.18.1
	... see 8.4	
B/G NET	Trigger  key function (Combics 2 only)	8.18.15
3.EXTERNAL	External control input 3	8.19
PRINT	Trigger  key function*	8.19.1
	... see 8.4	
B/G NET	Trigger  key function (Combics 2 only)	8.19.15
4.EXTERNAL	External control input 4	8.20
PRINT	Trigger  key function*	8.20.1
	... see 8.4	
B/G NET	Trigger  key function (Combics 2 only)	8.20.15
5.EXTERNAL	External control input 5	8.21
PRINT	Trigger  key function*	8.21.1
	... see 8.4	...
B/G NET	Trigger  key function (Combics 2 only)	8.21.15

OUTPUT

1.EXTERNAL	External control output 1	8.24
OP.READY	Weighing instrument ready to operate	8.24.1
STABL.	Weighing instrument stable	8.24.2
OVER.LD	Weighing instrument overload "H"	8.24.3
UNDR.LD	Weighing instrument underload "L"	8.24.4
TARE.OCC.	Tare memory allocated	8.24.5
UNDR.SQM.	Below SQmin load	8.24.6
OVER.SQM.	Above SQmin load	8.24.7
MINOR	Minor	8.24.8
PAIR	Pair	8.24.9
MAJOR	Major	8.24.10
SET	Set	8.24.11
2.EXTERNAL	External control output 2	8.25
OP.READY	Weighing instrument ready to operate	8.25.1
	... see 8.24	...
SET	Set	8.25.11
3.EXTERNAL	External control output 3	8.26
OP.READY	Weighing instrument ready to operate	8.26.1
	... see 8.24	...
SET	Set	8.26.11
4.EXTERNAL	External control output 4	8.27
OP.READY	Weighing instrument ready to operate	8.27.1
	... see 8.24	...
SET	Set	8.27.11
5.EXTERNAL	External control output 5	8.28
OP.READY	Weighing instrument ready to operate	8.28.1
	... see 8.24	...
SET	Set	8.28.11

SETUP / BARCODE 6

<i>REFERNC.</i>	Save value directly as reference*
<i>TARE</i>	Save value as tare value
<i>ID 1</i>	Save as ID 1
<i>INPUT</i>	Enter value on display (triggered when a key is pressed)
<i>EXT.KEYB</i>	External keyboard
<i>HEADER</i>	Save value as tare or ID code, depending on barcode header

SETUP / PRINT 7

<i>PROTOC.</i> Printouts	7
<i>HEADLIN.</i> Header entry	7.4
<i>LINE 1</i> Line 1	7.4.1
<i>LINE 2</i> Line 2	7.4.2
<i>IDENT. 1</i> Identifier 1	7.4.3
<i>IDENT. 2</i> Identifier 2	7.4.4
<i>IDENT. 3</i> Identifier 3	7.4.5
<i>IDENT. 4</i> Identifier 4	7.4.6
<i>IDENT. 5</i> Identifier 5	7.4.7
<i>IDENT. 6</i> Identifier 6	7.4.8
<i>QTY. 1</i> Printout quantity to COM1	7.5
<i>1 PRNT.0</i> 1 printout	7.5.1*
<i>2 PRNT.0</i> 2 printouts	7.5.2
<i>INDIV. 1</i> Single and results printout for all other applications, user-defined	7.6
<i>COMPON. 1</i> Component printout for net total and totalizing, user-defined	7.7 ¹⁾
<i>TOTAL 1</i> Totalizing results, user-defined	7.8 ¹⁾
<i>QTY. 2</i> Printout quantity to UniCOM	7.9
<i>1 PRNT.0</i> 1 printout	7.9.1
<i>2 PRNT.0</i> 2 printouts	7.9.2
<i>INDIV. 2</i> Single and results printout for all other applications, user-defined	7.6
<i>COMPON. 2</i> Component printout for net total and totalizing, user-defined	7.7
<i>TOTAL 2</i> Totalizing results, user-defined	7.8
<i>GMP.PROT</i> ISO/GMP printout	7.13
<i>OFF</i> Off	7.13.1*
<i>ON</i> On	7.13.2
<i>BAT./TIM</i> Date and time	7.14 ¹⁾
<i>BAT.+TIM</i> Date and time	7.14.1
<i>BAT.ONLY</i> Date only	7.14.2
<i>AUT.ONCE</i> Automatic printout after stability	7.15
<i>OFF</i> Off	7.15.1*
<i>ON</i> On	7.15.2
<i>FLEX.PRIN</i> Flex print	7.16
<i>OFF</i> Off	7.16.1*
<i>ON</i> On	7.16.2
<i>DEC.SEP.</i> Weight value decimal separator	7.17
<i>PERIOD</i> Period	7.17.1*
<i>COMMA</i> Comma	7.17.2
<i>ALIB.MEM</i> Printout of Alibi and product data memory	7.18
<i>ALL</i> Print all data records	7.18.1*
<i>SPEC.QTY.</i> Number of data record to be printed (enter no.)	7.18.2
<i>RESET</i> Reset factory settings	

¹⁾ Combics 2 only

SETUP / UTILIT.0

	SIGNAL Acoustic Signal		8.2
	ON	On	8.2.1*
	OFF	Off	8.2.2
	KEYS Release keypad		8.3
	ALL +	Release all	8.3.1*
	-ALL	All locked	8.3.2
	-NUM.PAD	Number pad locked	8.3.3
	-SCALE.N.	key locked	8.3.4
	-ZERO	key locked	8.3.5
	-TARE	key locked	8.3.6
	-FN	key locked	8.3.7
	-ISO.TST	key locked	8.3.8
	-PRINT	key locked	8.3.9
	-X 10	key locked	8.3.10 ¹⁾
	-B/G.NET	key locked	8.3.11 ¹⁾
	-CF	key locked	8.3.12 ¹⁾
	-REF	key locked	8.3.13 ¹⁾
	-OK	key locked	8.3.14 ¹⁾
	-TOGGLE	key locked	8.3.15 ¹⁾
	-INFO	key locked	8.3.16 ¹⁾
	-(-D-)	D key locked	8.3.17 ¹⁾
	-ID	d key locked	8.3.18 ¹⁾
	-MEM	R key locked	8.3.19 ¹⁾
	AUTO.OFF Automatic		
shutoff of display and control unit	8.7		
	TIMER	Automatic shutoff via timer (see 8.9)	8.7.1
	NONE	No automatic shutoff	8.7.2*
	BACKLIT Display lighting		8.8
	ON	On	8.8.1*
	OFF	Off	8.8.2
	AUTO.OFF	Automatic shutoff via timer (see 8.9)	8.8.3
	TIMER Timer for automatic shutoff		8.9
	1+1 MIN	After 1 minute warning displayed for 1 minute then off	8.9.1*
	2+2 MIN	After 2 minutes warning displayed for 2 minutes then off	8.9.2
	5+5 MIN	After 5 minutes warning displayed for 5 minutes then off	8.9.3
		Warning information: 12 flash simultaneously	
	START.WP Main scale: first platform displayed on start-up		8.11
	WP-1	Weighing platform 1	8.11.1*
	WP-2	Weighing platform 2	8.11.2
	DIS.GEOG. Show geographical data before calibration/adjustment		8.12
	ON	On	8.12.1
	OFF	Off	8.12.2*
	RESET Reset factory	settings	

SETUP / TIME

00.00.00 Input: hours.minutes.seconds (e.g. 14.10.30), confirm with the key

SETUP / DATE

00.00.00 Input: day.month.year (e.g. 13.08.10), confirm with the key U.S. mode: month.day.year (e.g. 08.13.10)

SETUP / U-CODE

----- Enter, change, delete user password (max. 8 characters)

Only in Service mode: SETUP / S-DATE

Date XXX entry

Only in Service mode: SETUP / SER.NO

2345 Serial number

Only in Service mode: SETUP / MODEL

CL2000 I Model description

Only in Service mode: SETUP / S-S0MIN

S0MIN1
S0MIN2¹⁾ CombiCS 2 only

SETUP / SQMIN

DISPLAY SQmin value display
 NO No*
 YES Yes

GMP PRT. GMP-compliant printout
 NO No*
 YES Yes

SETUP / ALIBI MEM

CLEAR Deletes the Alibi memory (Service only)
 PERIOD Entry of the save intervals in days (0 to 255)

Menu info (device information)

* = Factory setting

INFO / SERVICE

Service date

Input: day.month.year (e.g. 13.08.10), confirm with the $\rightarrow T \leftarrow$ key
 U.S. mode: month.day.year (e.g. 08.13.10)

INFO / TERM

Indicator

CL2000 I Model type
 12345 Serial number (complete display with the $\rightarrow T \leftarrow$ key)
 0 1-62-0 I Indicator version number (complete display with the $\rightarrow T \leftarrow$ key)
 C2 102008 10 Software version (complete display with the $\rightarrow T \leftarrow$ key)
 PCB03 Main PC board type

INFO / WP-1

1st weighing platform

00-42-5 I Software version 1st weighing platform
 5 1.53 Geographic latitude in degrees
 15 1 Geographic altitude in meters
 9.8 1 Acceleration of gravity m/s² (then however no latitude and altitude)
 SWITCH Menu access switch

INFO / WP-2

2nd weighing platform (e.g. IS weighing platform)

YCO0 1 15 Type description of 1st weighing platform
 0 1.02.07 Software version 2nd weighing platform
 10404354 Serial number
 5 1.53 Geographic latitude in degrees
 15 1 Geographic altitude in meters
 8.9 1 Acceleration of gravity m/s²

INFO / FLEX INF

Flex print

----- File name
 ID--- ID
 V--- Version

Language menu (language settings for display, calibration and GMP-compliant printouts)

* = Factory setting

LANGUAG. Factory settings: LANGUAG.

DEUTSCH German
 ENGLISH English*
 U.S. MODE English with U.S. date/time
 FRANÇ. French
 ITAL. Italian
 ESPAÑOL Spanish
 CODES Mixed menu display: English and number menu structure

ADC settings menu

* = Factory setting

ADC.CON

STANDARD	Standard configuration		9.1.3
<i>RANGES</i>	Ranges		11.3
	<i>SINGLE</i>	Single-range scale	11.3.1
	<i>MULT.INT</i>	Multi-interval scale	11.3.2
	<i>MULT.RNG</i>	Multiple-range scale	11.3.3
<i>SINGLE</i>	Single-range scale		11.4
	<i>d</i>	Scale interval d	11.4.1
	<i>MAX.</i>	Max. load	11.4.4
<i>MULT.INT</i>	Multi-interval scale		11.5
	<i>d</i>	Scale interval d	11.5.1
	<i>RANGE 1</i>	Range 1	11.5.4
	<i>RANGE 2</i>	Range 2	11.5.5
	<i>RANGE 3</i>	Range 3	11.5.6
	<i>MAX.</i>	Max. load	11.5.7
<i>MULT.RNG</i>	Multiple-range scale		11.6
	<i>d</i>	Scale interval d	11.6.1
	<i>RANGE 1</i>	Range 1	11.6.4
	<i>RANGE 2</i>	Range 2	11.6.5
	<i>RANGE 3</i>	Range 3	11.6.6
	<i>MAX.</i>	Max. load	11.6.7
<i>WT.UNIT</i>	Available weight units		11.7
	<i>FREE</i>	User-defined / o	11.7.1
	<i>G</i>	Grams /g	11.7.2
	<i>KG</i>	Kilograms /kg	11.7.4

	<i>T</i>	Tons /t	11.7.21
	<i>LB</i>	Pound:ounces / lb oz	11.7.22
<i>CAL.UNIT</i>	Calibration / Adjustment unit		11.8
	<i>FREE</i>	User-defined / o	11.8.1
	<i>G</i>	Grams /g	11.8.2
	<i>KG</i>	Kilograms /kg	11.8.3

	<i>T</i>	Tons /t	11.8.21
<i>SAVE</i>	Save configuration parameters		11.10
	<i>YES</i>	Yes	11.10.1
	<i>NO</i>	No	11.10.2
VERIF.	Verifiable configuration		9.1.4
<i>CLASS</i>	Accuracy class		11.1
	Class III / III		11.1.4
<i>RANGES</i>	Ranges		11.3
	<i>SINGLE</i>	Single-range scale	11.3.1
	<i>MULT.INT</i>	Multi-interval scale	11.3.2
	<i>MULT.RNG</i>	Multiple-range scale	11.3.3
<i>SINGLE</i>	Single-range scale		11.4
	<i>E</i>	Verification scale interval e	11.4.2
	<i>MIN.</i>	Min. load	11.4.3
	<i>MAX.</i>	Max. load	11.4.4
<i>MULT.INT</i>	Multi-interval scale		11.5
	<i>E</i>	Verification scale interval e	11.5.2
	<i>MIN.</i>	Min. load	11.5.3
	<i>RANGE 1</i>	Range 1	11.5.4
	<i>RANGE 2</i>	Range 2	11.5.5
	<i>RANGE 3</i>	Range 3	11.5.6
	<i>MAX.</i>	Max. load	11.5.7
<i>MULT.RNG</i>	Multiple-range scale		11.6
	<i>E</i>	Verification scale interval e	11.6.2
	<i>MIN.</i>	Min. load	11.6.3
	<i>RANGE 1</i>	Range 1	11.6.4
	<i>RANGE 2</i>	Range 2	11.6.5
	<i>RANGE 3</i>	Range 3	11.6.6
	<i>MAX.</i>	Max. load	11.6.7

<i>WT.UNIT</i>	Available weight units		11.7
	<i>FREE</i>	User-defined / o	11.7.1
	<i>G</i>	Grams /g	11.7.2
	<i>KG</i>	Kilograms /kg	11.7.4
	
	<i>T</i>	Tons /t	11.7.21
	<i>LB</i>	Pound:ounces / lb oz	11.7.22
<i>CAL.UNIT</i>	Calibration / Adjustment unit		11.8
	<i>FREE</i>	User-defined /o	11.8.1
	<i>G</i>	Grams /g	11.8.2
	<i>KG</i>	Kilograms /kg	11.8.3
	
	<i>T</i>	Tons /t	11.8.21
<i>SAVE</i>	Save configuration parameters		11.10
	<i>YES</i>	Yes	11.10.1
	<i>NO</i>	No	11.10.2

Index

Accessories	122	EC type-approval certificate	129
Accessories for connection to a PC	14	Entering calibration weight	26
Acoustic signal	43	Entering geographical data	24
Activating the service mode	18	Entering linearization weights	26
ADC, analog/digital converter	19	Equipment settings overview	135
Adjustment without weights	30	Equipment supplied	8
Animal weighing	63	Error messages	115
Applications advice	3	External keys	144
Applications overview	53	External linearization	27
Assigning a function to the  key	26	External switch	147
Attaching cables	9	General password	157
Attaching interface cables	9	General view of the equipment	7
Automatic data output	105	GMP-compliant printouts	111
Averaging	63	Guide to verification of weighing instruments	152
Cabling diagram connecting to a PC	14	Identifiers	41, 51, 148
Calibration	47	Individual identifiers	2, 40, 51
Calibration/Adjustment	47	Installation location	8
CE mark	126	Intended use	6
Checkweighing	72	IP protection rating	5
Classification	80	ISO test key	26
Cleaning	116	Key functions	32
Cleaning stainless steel surfaces	117	Language settings	37
Closing the indicator	15	Maintenance	116
COM1 interface settings	142	Net total formulation	89
Commissioning	9	Neutral measurement	59
Configuration	37	Opening the indicator	9
Configure data output	107	Operating design	31
Configuring printouts	96	Operating menu overview	135
Connect a barcode scanner	16	Operation	40
Connect a weighing platform	11	Passwords	157
Connecting the device to AC power	15	PC connection	14
Connection options	103	Pin assignment chart	13
Counting	54	Plates and markings	131
Data input format	106	Printer interface configuration	110
Data interfaces	102	Printout configuration	110
Data output format	107	Printout samples	113
Data protocol settings	143	Printout samples	113
Date settings	149	Printout settings	110
Declaration of conformity	126	Product data memory	100
Deleting the preload	29	Range selection	21
Device functions	53	Repairs	116
Device information	150	Replacing the dust cover	117
Device parameters	37, 43		
Device parameters overview	135		
Dimensions	121		
Display lighting	43		
Display modes	34		
Disposal	118		

Safety inspection	117
Safety instructions	4
Sample printout	113
SBI communication	105
Service	116
Service menu	17
Service password	157
Setting parameters	21
Configuration	23
Setting the preload	28
Setting the time	149
Setting up password protection	38
Shutoff, automatic	43
SMA communication	105
Technical data	119
Totalizing	85
Type-approval certificate	129
Universal printer	144
Unpacking	8
Using in legal metrology	5
Verification guide	155
Warm-up time	15
Weighing	40
Weighing in percent	67
Weighing platform 1 settings	140



Konformitätserklärung *Declaration of Conformity*

Sartorius Weighing Technology GmbH
Weender Landstr. 94 - 108
37075 Goettingen, Germany

erklärt in alleiniger Verantwortung, dass das Betriebsmittel
declares under own responsibility that the equipment

Geräteart: **Combics Indikator**
Device type: Combics indicator

Baureihe / *Type series*: **CAIS1, CAIS2, CAIS3, CAISL1, CAISL2, CAISL3**

übereinstimmt mit den Regelungen der Europäischen Richtlinie (in der heute gültigen Fassung):
complies with the regulations of the European Directive (in the today valid version):

Richtlinie 2002/95/EG **Zur Beschränkung der Verwendung bestimmter gefährlicher Stoffe
in Elektro- und Elektronikgeräten**

Directive 2002/95/EC **on the restriction of the use of certain hazardous substances in electrical
and electronic equipment**

sofern das Betriebsmittel gekennzeichnet ist mit:
provided that the equipment is marked with:



Sartorius Weighing Technology GmbH
Goettingen, 2012-05-03

Dr. Reinhard Baumfalk
Vice President R&D

Dr. Dieter Klausgrete
Head of International Certification Management

Diese Erklärung bescheinigt die Übereinstimmung mit den genannten EG-Richtlinien, ist jedoch keine Zusicherung von Eigenschaften. Bei einer mit uns nicht abgestimmten Änderung des Produktes verliert diese Erklärung ihre Gültigkeit. Die Sicherheitshinweise der zugehörigen Produktdokumentation sind zu beachten.

This declaration certifies conformity with the above mentioned EC Directives, but does not guarantee product attributes. Unauthorised product modifications make this declaration invalid. The safety information in the associated product documentation must be observed.

Appendix: Guide to verification of weighing instruments

Evidence of compatibility for modules used with non-automatic weighing instruments

The documents required to verify a weighing instrument for legal metrology can be created using the data, documents, and programs available from the Sartorius website. The printout of the completed forms is valid as a model for verification of the weighing instrument produced by the scale manufacturer. Once this has been properly completed and signed by the weighing instrument manufacturer, it is submitted to the weights and measures officer together with the Declaration of Conformity (s. "Declaration of Conformity" section).

Information important to the weights and measures officer may include the type approval certificate, test certificate or a test report. The test certificate and the manufacturer's information concerning the weigh cell will also be required.

Filling in the evidence of compatibility:

- ▶ The Guide to Verification, complete with Excel file, documents and information, is available online at: http://www.sartorius.com/leitfaden_eichen/

Creating the evidence of compatibility without internet access:

- ▶ You can order the "Guide to Verification of Weighing Instruments" on CD-ROM directly from Sartorius.
Order address:

Sartorius
Hotline Dept.
Weender Landstrasse 94-108
37075 Goettingen, Germany
Phone: +49.551.308.4440
Fax: +49.551.308.4449
www.sartorius.com

- ▶ Select the required language version by clicking on the corresponding language.
- ▶ Select the required indicator at the top of the page.

Using the program

ReadMe file

Read this file before opening the Excel file. The ReadMe file contains important information about using the Excel file, and offers important information on filling out the documents.

Documents

All documents relevant to the compatibility declaration of the indicator are available (please click on the appropriate links).

Start

- ▶ Click on "Start the Excel Program."
- ▷ The Excel file automatically opens with the Excel program. MS-Excel must already be installed on your computer. A dialog box for selecting macros opens.
- ▶ Click on the "Activate macros" button.
- ▷ Note: This window might not open, depending on the settings in your computer system.
- ▶ All fields on the "Data" page (highlighted in yellow) must be filled out by a qualified person.
- ▷ A filled out sample document is available in the "Documents" folder with explanations of the fields that are highlighted in yellow. Once the technical specifications provided by the manufacturer have been entered correctly, the program calculates all values automatically.

On the last page, the green or red fields show whether the components (indicator and weigh cell/s) are compatible:

Red = incompatible

Green = compatible

Note: A manufacturer of weighing equipment who configures a weighing instrument from individual components (indicator and weigh cell/s) is responsible for the specifications in the documentation.

- ▶ Once all data has been entered correctly (all fields on page 2 are green), print out both pages.
- ▶ The file can then be archived (for example, saved on the PC) under a name of your choice.
- ▶ Double-check the information and sign the data sheet.

Legal Terms and Conditions

Copyright

This documentation may not be duplicated or transmitted for any purpose whatsoever, either in whole or in part, without the express written permission of Sartorius. All rights defined under copyright law are reserved by Sartorius.

The program is intended for use by the purchaser only. Transfer to third parties, whether free of charge or in return for payment, is not permitted. The software may not be modified, reverse engineered or changed by assimilation.

The Excel program used here was developed by the German Association of Metrology and Calibration (Arbeitsgemeinschaft für Mess- und Eichwesen (AGME)). It is also available as freeware on the Internet. The program is copyrighted and may not be modified. Users shall be liable for the improper use of said software.

Appendix: General password

After selecting the “Setup” menu item a request to enter the access password “0000” will be displayed for 2 seconds.

▷ The first digit in the display flashes.

Combics 2 Numbers and the point can be entered via the number pad.

Combics 1 and 2 **Select characters** using the **Fn** and **F7** keys

Fn key displays: Numbers in ascending order (0 to 9)
then the characters . and -
then letters in descending order (from Z to A)

F7 key displays: Letters in alphabetical order A to Z
then the characters - and .
then numbers in descending order 9 to 0

- Fn** or **F7** key multiple times
- ▶ Press the **Fn** or **F7** keys until the desired character is displayed.
 - T←** ▶ Confirm the displayed character using the **→T←** key.
 - ▷ The second digit in the display flashes.
 - ▶ Enter all additional characters in the same way.
 - ▷ If the password is longer than 7 characters the first character will be displaced to the left and out of the display.
 - T←** ▶ Confirm the entered password using the **→T←** key.
 - 0←** ▶ Exit the menu level using the **→0←** key.
 - T←** hold ▶ Press and hold the **→T←** key until you switch to the Operating mode.

General password: 40414243

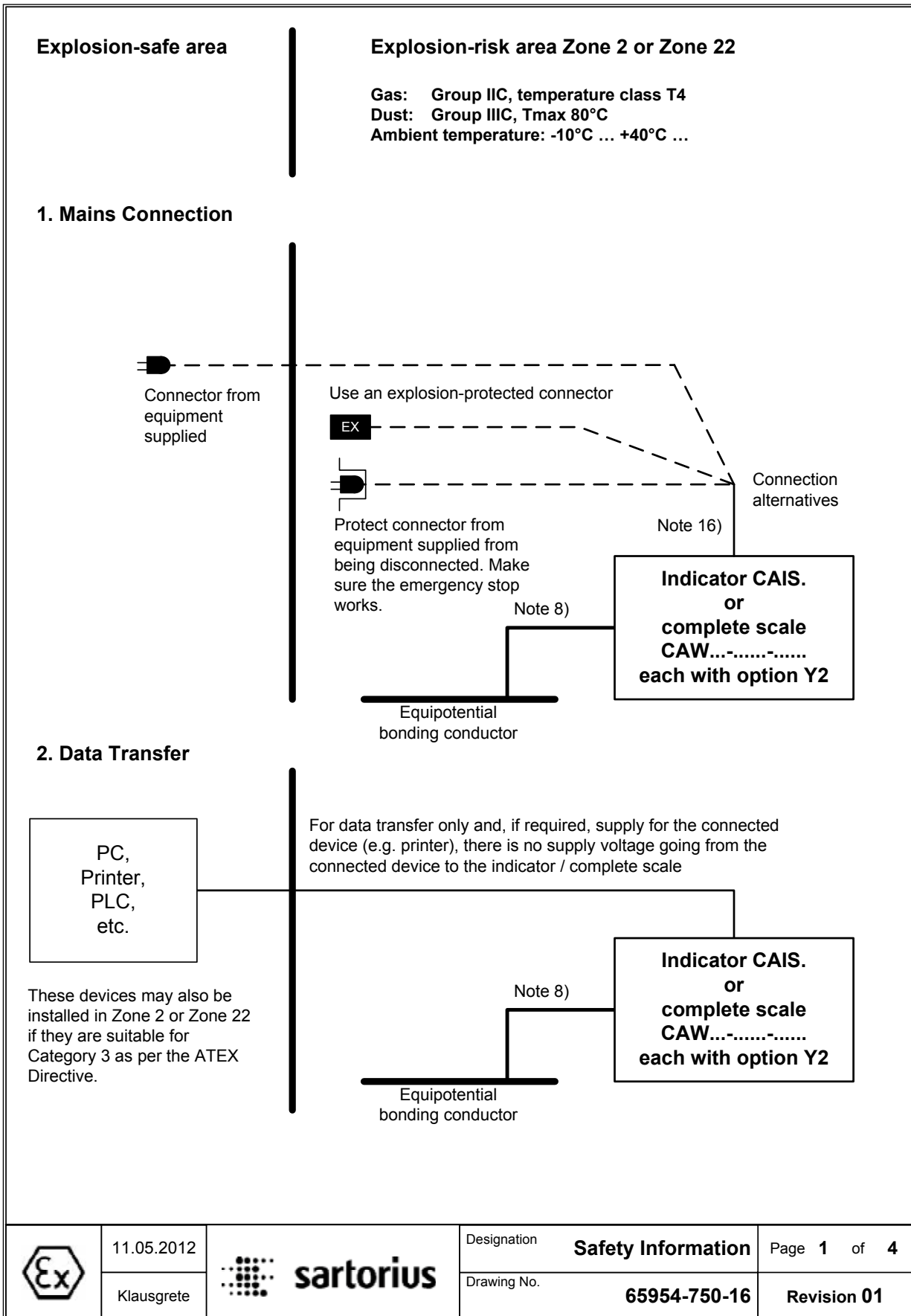

Service password: 202122

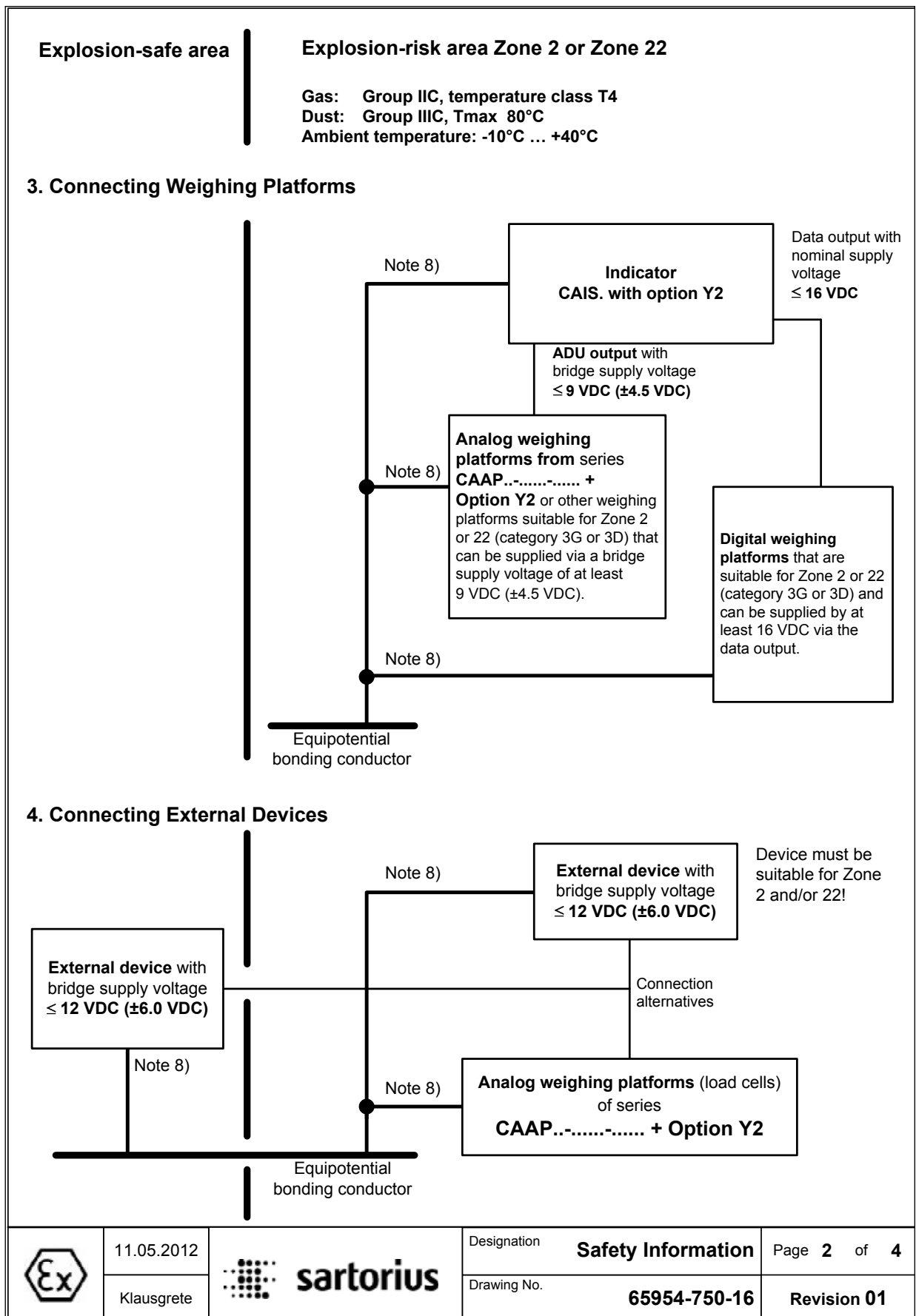





These safety instructions apply to installation, use, maintenance and repair

1. The device (CAIS, indicator, CAAP weighing platform...-.....-....., CAW complete scale...-.....-.....) is suitable for use in potentially explosive atmospheres of **Zone 2** (Group IIC, temperature class T4 or T6 for weighing platforms) and **Zone 22** (Group IIIC; surface temperature 80°C) according to EU Directive 94/9/EC and applicable harmonized European standards. This does not guarantee compliance with other properties and requirements.
2. The device may only be used indoors.
3. Do not use it as a portable instrument.
4. Installation, operation, maintenance and repairs should only be performed by an authorized specialist, in accordance with applicable laws, rules and regulations, ordinances and standards. Particular attention should be paid to Standard EN 60079-14 within the scope of validity of EU Directive 94/9/EC for the installation. Installation, maintenance, cleaning and repair work may only take place with all power disconnected from the device and any connected peripheral devices.
5. It is essential that recommendations on the installation, operation, maintenance and repair contained in the operating instructions supplied are complied with for all equipment (including connected devices). The temperature ranges of connected devices must also be taken into account.
6. The device should only be used in a temperature range of **-10°C ... +40°C**, do not expose it to unacceptable sources of heat or cold, direct sunlight, UV radiation, shocks or vibrations, and the installation should ensure that heat can be properly dissipated and external heat sources are kept at a sufficient distance.
7. Tighten the cable entry glands using a torque of 5 Nm. The cable gland for the power cord should be tightened with a torque of only 3 Nm. Install the external connecting cables firmly to avoid damage and strain. The cable connections inside the explosion-risk area must be secured against loosening.
8. All metal parts must be electrically connected to the same equipotential bonding conductor (PA) so that any electrostatic charges can be conducted away from the equipment. For this purpose, the equipment operator is obligated to connect a lead with a gauge of at least 4 mm² (cross section) to the equipotential bonding terminal (indicated by the ground symbol) located on the housing. A suitable ring terminal must be attached to the end of the cable. The cable must be laid so that the ground connector cannot come loose. The connection to the equipotential bonding conductor should be checked to see if it is of low resistance at the time of installation and at regular intervals. The indicator and weighing platform must each be connected individually to the equipotential bonding conductor if no metal connection (e.g. support arm) is used between them. Do not use the shield of the connection cable for the equipotential bonding conductor.
9. Before opening devices, switch off the supply voltage, or make sure that the area is not potentially explosive. Do not connect or disconnect any live cables inside an explosion-risk area.
10. When closing, make sure the cover screws are tightly secured.
11. The device should only be operated for the first time when it is certain that the area is not potentially explosive.
12. Data lines to connected devices and the connection cable to the weighing platform should be secured against accidental disconnection and may only be connected and disconnected when the power supply is turned off. Block unused outlets to guarantee the IP 65 level of protection. Keep any transitory voltage phenomenon away from the device.
13. Data cables are for data transfer only and may not supply any power from the connected device to the indicator / complete scale. However, one digital weighing platform suitable for use in Zone 2 or 22 connected to the data output can be supplied via direct voltage if it can be supplied by direct voltage of at least 16 VDC via the data output.

	11.05.2012		Designation	Safety Information	Page 3 of 4
	Klausgrete		Drawing No.	65954-750-16	Revision 01

14. During installation, take suitable steps to prevent stray electrical interference (e.g. due to magnetic fields). Keep any voltage transients away from the device.
15. The indicator (indicator of the complete scale) should be installed so that there is only a low risk of mechanical danger to the IP protection. The IP protection rating of the device is IP6x according to EN 60529 / IEC 60529. The device is designed for clean environments and must be handled carefully according to the IP protection rating.
16. The power connection must be made in accordance with the regulations applicable in the country of operation. A correct power connection must be ensured. The power supply cable should be protected against damage and properly connected to the power supply (**100 - 240 VAC, ± 10%**, 50-60Hz) or **24 VDC (± 10%)** for Option L8. The indicator and/or complete scale is approved for circuits up to 1500 A. Only use the power supply connection cable in the hazardous area with a suitable and approved explosion-protected plug. Alternatively: Protect connector from being disconnected or attach the power supply connection cable directly. Be sure to provide a suitable emergency shut-off switch.
17. Avoid generating static electricity. Only use a damp cloth to clean the device. This is especially true when using a dust cover. The equipment operator assumes responsibility for preventing any risks caused by electrostatic charging.
18. If cables are connected subsequently, make sure that the connections are not corroded. The grounding conductor of a mains connection cable must have the same cross section as the current-carrying wires (N and L).
19. All external cables (even cables between load cells / weigh cells and connection box / junction box) are only suitable for fixed placement and must be laid fixed. Otherwise, use screwed connections designed according to EN60079-0 and rounded at an angle of 75° (minimum) and a radius at least equal to one-quarter of the diameter of the cables, but without exceeding 3 mm.
20. Cables from third-party manufacturers (subject to the user's responsibility) must be tested for suitability according to Appendix A EN 60079-0. Pay attention to the pin assignment. Pay attention to the wiring diagram. Remove unneeded connections.
21. Unused openings must be sealed using suitable cover caps (dummy plugs) to ensure their IP protection rating. Do not remove while it is carrying current.
22. When using external devices in Zone 2 hazardous areas, pay attention to the gas group and temperature class. The outputs must include the Ex nA electrical circuits. Pay attention to the maximum surface temperature and group for Zone 22.
23. Chemicals that can attack housing gaskets and cable sheathings must be kept away from the device. These include oil, grease, benzene, acetone, and ozone. If you are uncertain, contact the manufacturer.
24. The installation must be inspected for correct function and safety by a trained and qualified person at appropriate intervals.
25. If the installation does not operate properly, disconnect it from the supply voltage immediately and secure it against further use.
26. In the event of repair, use only original spare parts supplied by the manufacturer.
27. Any modifications to the instrument (except by persons authorized by Sartorius) cause loss of conformity for use in Zone 2 and Zone 22 explosion-risk areas and invalidate all guarantee claims. Similarly, the device may only be opened by qualified and authorized personnel.
28. Modifications (also those by Sartorius personnel) are subject to written approval.
29. These instructions are given in addition to those in the instruction manuals and do not release the operator from his responsibilities for the installation, operation and inspection of the equipment in compliance with any applicable regulations in the country of use.

	11.05.2012		Designation	Safety Information	Page 4 of 4
	Klausgrete		Drawing No.	65954-750-16	Revision 01

Sartorius Weighing Technology GmbH
Weender Landstrasse 94–108
37075 Goettingen, Germany

Phone +49.551.308.0
Fax +49.551.308.3289
www.sartorius-mechatronics.com

Copyright by Sartorius,
Goettingen, Germany.

No part of this publication may be
reprinted or translated in any form
or by any means without the prior writ-
ten permission of Sartorius.

All rights reserved.

The status of the information,
specifications and illustrations in
this manual is indicated by the date
given below. Sartorius reserves
the right to make changes to the
technology, features, specifications and
design of the equipment
without notice.

Status:

March 2012,
Sartorius Weighing Technology GmbH,
Goettingen, Germany

Printed in Germany.
Printed on bleached, chlorine-free paper
RS- KT
Publication no.: WCA6007-e12036