

HARDY

HARDY®

Hardy Price Index By Rice Lake PN

| RL PN | SUGGESTED LIST | PAGE # | RL PN | SUGGESTED LIST | PAGE # | RL PN | SUGGESTED LIST | PAGE # |
|------------|----------------|--------|-----------|----------------|--------|-----------|----------------|--------|
| 13720 | CONSULT/ FT | 275 | 0525-0074 | CONSULT | 272 | 0525-0196 | CONSULT | 268 |
| 13721 | CONSULT/ FT | 275 | 0525-0075 | CONSULT | 272 | 0525-0199 | CONSULT | 268 |
| 0525-0035 | CONSULT | 275 | 0525-0077 | CONSULT | 272 | 0525-0200 | CONSULT | 274 |
| *0525-0037 | CONSULT | 275 | 0525-0133 | CONSULT | 270 | 0525-0203 | CONSULT | 268 |
| 0525-0045 | CONSULT | 275 | 0525-0134 | CONSULT | 270 | 0525-0204 | CONSULT | 274 |
| 0525-0047 | CONSULT | 275 | 0525-0143 | CONSULT | 269 | 0525-0207 | CONSULT | 268 |
| 0525-0049 | CONSULT | 275 | 0525-0144 | CONSULT | 269 | 0525-0208 | CONSULT | 274 |
| 0525-0051 | CONSULT | 275 | 0525-0146 | CONSULT | 269 | 0525-0215 | CONSULT | 273 |
| 0525-0053 | CONSULT | 275 | 0525-0147 | CONSULT | 269 | 0525-0216 | CONSULT | 273 |
| 0525-0055 | CONSULT | 275 | 0525-0148 | CONSULT | 269 | 0525-0223 | CONSULT | 273 |
| 0525-0056 | CONSULT | 272 | 0525-0149 | CONSULT | 270 | 0525-0224 | CONSULT | 273 |
| 0525-0057 | CONSULT | 274 | 0525-0152 | CONSULT | 274 | 0525-0225 | CONSULT | 273 |
| 0525-0059 | CONSULT | 271 | 0525-0153 | CONSULT | 274 | 0525-0226 | CONSULT | 273 |
| 0525-0060 | CONSULT | 272 | 0525-0154 | CONSULT | 274 | 0525-0227 | CONSULT | 273 |
| 0525-0061 | CONSULT | 271 | 0525-0155 | CONSULT | 274 | 0525-0228 | CONSULT | 273 |
| 0525-0063 | CONSULT | 271 | 0525-0156 | CONSULT | 274 | 0525-0507 | CONSULT | 271 |
| 0525-0064 | CONSULT | 271 | 0525-0194 | CONSULT | 268 | 0525-0508 | CONSULT | 271 |
| 0525-0070 | CONSULT | 272 | 0525-0195 | CONSULT | 268 | 0525-0509 | CONSULT | 271 |

*Item obsolete or discontinued. When remaining stock is depleted, published prices are withdrawn and the item is subject to a special order quote.

Call for details.

HARDY®

Hardy Cross Reference By Equivalent Hardy Number

| EQUIV. HARDY # | RL PN | PAGE # | EQUIV. HARDY # | RL PN | PAGE # | EQUIV. HARDY # | RL PN | PAGE # |
|-------------------|-----------|--------|-------------------|-----------|--------|-------------------|-----------|--------|
| 2K201 | 0525-0060 | 272 | 7K201 | 0525-0075 | 272 | 10K2001 | 0525-0133 | 270 |
| 2K308 | 0525-0041 | XX | 7K303 (OLD) | 0525-0508 | 271 | 10K2002 | 0525-0134 | 270 |
| 2K309 | 0525-0043 | XX | 7K308 | 0525-0053 | 275 | 10KX2000 | 0525-0151 | XX |
| 2K1203 | 0525-0196 | 268 | 7K309 | 0525-0055 | 275 | 12K201 | 0525-0070 | 272 |
| 2KX111 | 0525-0225 | 273 | 7K1203 | 0525-0203 | 268 | 12K303 | 0525-0059 | 271 |
| 3K303 | 0525-0061 | 271 | 7K1205 | 0525-0204 | 274 | 12K309 | 0525-0266 | XX |
| 3K303 (OLD) | 0525-0507 | 271 | 7K2001 | 0525-0148 | 269 | 12K1203 | 0525-0221 | XX |
| 3K308 | 0525-0045 | 275 | 7K2002 | 0525-0149 | 270 | 13K711 | 0525-0033 | XX |
| 3K309 | 0525-0047 | 275 | 7KX111 | 0525-0227 | 273 | 13K1303 | 0525-0194 | 268 |
| 3K2001 | 0525-0143 | 269 | 7KX2000 | 0525-0155 | 274 | 13K1314 | 0525-0195 | 268 |
| 3K2002 | 0525-0144 | 269 | 8K201 | 0525-0077 | 272 | 13K1408 | 0525-0012 | XX |
| 3KX2000 | 0525-0152 | 274 | 8K303 | 0525-0064 | 271 | 13K1409 | 0525-0013 | XX |
| 4K201 | 0525-0074 | 272 | 8K303 (OLD) | 0525-0509 | 271 | 13K1410 | 0525-0014 | XX |
| 4K308 | 0525-0049 | 275 | 8K1203 | 0525-0207 | 268 | 13KX109 | 0525-0223 | 273 |
| 4K309 | 0525-0051 | 275 | 8K1205 | 0525-0208 | 274 | 13KX110 | 0525-0224 | 273 |
| 4K1203 | 0525-0199 | 268 | 8KX111 | 0525-0228 | 273 | 16K201 | 0525-0174 | XX |
| 4K1205 | 0525-0200 | 274 | 8KX2000 | 0525-0156 | 274 | D2542-9-B | 0525-0181 | XX |
| 4KX111 | 0525-0226 | 273 | 10K201 | 0525-0056 | 272 | KX123 | 0525-0215 | 273 |
| 4KX2000 | 0525-0153 | 274 | 10K308 | 0525-0035 | 275 | KX124 | 0525-0216 | 273 |
| 5K2001 | 0525-0146 | 269 | 10K309 | 0525-0037 | 275 | KX142 | 0525-0217 | XX |
| 5K2002 | 0525-0147 | 269 | 10K311 | 0525-0057 | 274 | | | |
| 5KX2000 | 0525-0154 | 274 | 10K1203 | 0525-0190 | XX | | | |

*Item obsolete or discontinued. When remaining stock is depleted, published prices are withdrawn and the item is subject to a special order quote.

XX Call for details.

Hardy Scale Models and Gross Capacities

| MODEL | GROSS CAPACITY |
|-------|------------------|
| HS-1 | 0-625 LB |
| HS-2 | 626-1,250 LB |
| HS-3 | 1,251-2,500 LB |
| HS-4 | 2,501-6,250 LB |
| HS-5 | 6,251-7,500 LB |
| HS-6 | 7,501-11,250 LB |
| HS-7 | 11,251-25,000 LB |
| HS-8 | 12,501-25,000 LB |
| HS-9 | 25,001-30,000 LB |
| HS-10 | 30,001-37,500 LB |
| HS-11 | 37,501-50,000 LB |
| HS-12 | 50,001-62,500 LB |

Individual Hardy Scale Parts

Bearings

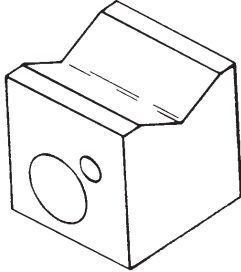
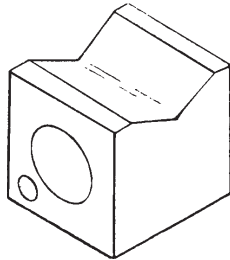
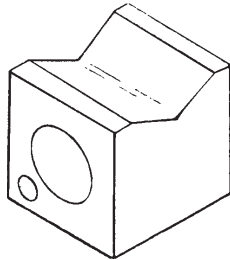
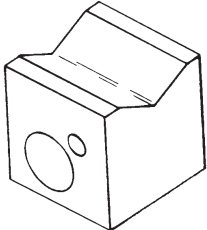
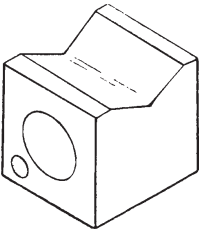
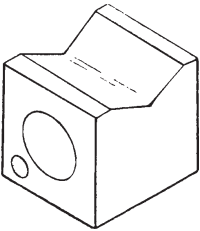
| RL PN | DESCRIPTION | SUGG. LIST | |
|-----------|--|------------|---|
| 0525-0194 | Equiv. Hardy no. 13K1303 Size: 15/16 in x 15/16 in x 1 1/32 in Hole size: 0.453 or 29/64 in dia Spacer: 0525-0200 Fits shackle no. 0525-0223, 0525-0224 Extension lever: all models (1/2 in bar) Type A Bearing | Consult |  |
| 0525-0195 | Equiv. Hardy no. 13K1314 Size: 1 1/4 in x 1 1/4 in x 1 7/16 in Hole size: 0.578 or 37/64 in dia Spacer: 0525-0204 Fits shackle no. 0525-0217 Extension lever: H.D. (3/4 in bar) Type B Bearing | Consult |  <p>TYPE B</p> |
| 0525-0196 | Equiv. Hardy no. 2K1203 Size: 15/16 in x 15/16 in x 31/32 in Hole size: 0.453 or 29/64 in dia Spacer: 0525-0200 Fits shackle no. 0525-0225 Models: hs-1, HS-2 Type A Bearing | Consult |  <p>TYPE C</p> |
| 0525-0199 | Equiv. Hardy no. 4K1203 Size: 15/16 in x 15/16 in x 29/32 in Hole size: 0.453 in or 29/64 in dia Spacer: 0525-0200 Fits shackle no. 0525-0215 Models: HS-3, HS-4 Type A Bearing | Consult |  <p>TYPE A</p> |
| 0525-0203 | Equiv. Hardy no. 7K1203 Size: 1 1/4 in x 1 1/4 in x 1 3/16 in Hole size: 0.578 in or 37/64 in dia Spacer: 0525-0204 Fits shackle no. 0525-0227 Models: hs-5, HS-6, HS-7 Type B Bearing | Consult |  |
| 0525-0207 | Equiv. Hardy no. 8K1203 Size: 1 1/4 in x 1 1/2 in x 1 3/8 in Hole size: 0.719 in or 23/32 in dia Spacer: 0525-0208 Fits shackle no. 0525-0228 Model: HS-8 Type B Bearing | Consult |  <p>TYPE B</p> |

Individual Hardy Scale Parts

Bearings (Cont.)

| RL PN | DESCRIPTION | SUGG. LIST |
|-----------|---|------------|
| 0525-0143 | <p>Equiv. Hardy no. 3K2001 Size: 1 1/4 in x 5/8 in x 2 3/16 in Hole size: 3/8 in dia x 1 9/16 in center to center Fits shackle no. 0525-0152 Models: HS-1, HS-2, HS-3 Upper bearing</p> | Consult |
| 0525-0144 | <p>Equiv. Hardy no. 3K2002 Size: 1 1/4 in x 5/8 in x 3 5/8 in Hole size: 3/8 in dia x 3 in center to center Fits shackle no. 0525-0152 Models: HS-1, HS-2, HS-3 Lower bearing</p> | Consult |
| 0525-0146 | <p>Equiv Hardy no. 5K2001 Size: 1 1/4 in x 3/4 in x 2 5/8 in Hole size: 1/2 in dia x 1 3/4 in center to center Fits shackle no. 0525-0153, 0525-0154 Models: HS-4, HS-5 Upper bearing</p> | Consult |
| 0525-0147 | <p>Equiv. Hardy no. 5K2002 Size: 1 1/4 in x 3/4 in x 4 1/2 in Hole size: 1/2 in dia x 3 5/8 in center to center Fits shackle no. 0525-0153, 0525-0154 Models: HS-4, HS-5 Lower bearing</p> | Consult |
| 0525-0148 | <p>Equiv. Hardy no. 7K2001 Size: 1 1/4 in x 3/4 in x 3 9/16 in Hole size: 5/8 in dia x 2 7/16 in center to center Fits shackle no. 0525-0155 Models HS-6, HS-7</p> | Consult |

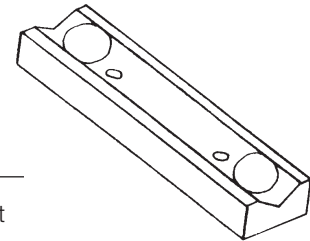

HARDY®

Individual Hardy Scale Parts

Bearings (Cont.)

| RL PN | DESCRIPTION | SUGG. LIST |
|-----------|--|------------|
| 0525-0149 | Equiv. Hardy no. 7K2002 Size: 1 1/4 in x 3/4 in x 5 3/4 in Hole size: 5/8 in dia x 4 5/8 in center to center Fits shackle no. 0525-0155 Models: HS-6, HS-7 Lower bearing | Consult |
| 0525-0133 | Equiv. Hardy no. 10K2001 Size: 1 1/4 in x 1 in x 3 7/8 in Hole size: 11/16 in dia x 2 5/8 in center to center Fits shackle no. 0525-0156, 0525-0151 Models: HS-8, HS-9, HS-10 Upper bearing | Consult |
| 0525-0134 | Equiv. Hardy no. 10K2002 Size: 1 1/4 in x 1 in x 6 3/8 in Hole size: 11/16 in dia x 5 1/8 in center to center Fits shackle no. 0525-0156, 0525-0151 Models: HS-8, HS-9, HS-10 Lower bearing | Consult |

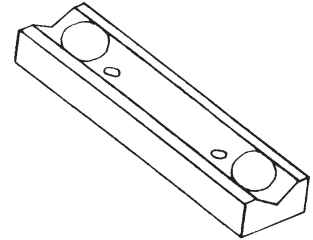

Individual Hardy Scale Parts

Pivots

| RL PN | DESCRIPTION | SUGG. LIST |
|-----------|---|------------|
| 0525-0061 | Equiv. Hardy no. 3K303 Size: 1/2 in x 1/2 in x 1/2 in Fits splice nose iron: 0525-0041, 0525-0043, 0525-0045, 0525-0047 Models: HS-1, HS-2, HS-3 Pivot | Consult |
| 0525-0063 | Equiv. Hardy no. 7K303 Size: 1/2 in x 1/2 in x 5/8 in Fits splice nose iron: 0525-0049, 0525-0051, 0525-0053, 0525-0055 Models: HS-4, HS-5, HS-6, HS-7 Pivot | Consult |
| 0525-0064 | Equiv. Hardy no. 8K303 Size: 1/2 in x 1/2 in x 3/4 in Fits splice nose iron: 0525-0035, 0525-0037 Models: HS-8, HS-9, HS-10 Pivot | Consult |
| 0525-0059 | Equiv. Hardy no. 12K303 Size: 1/2 in x 3/4 in x 1 in Fits splice nose iron: 0525-0265, 0525-0266 Models: HS-11, HS-12 Pivot | Consult |
| 0525-0507 | Equiv. Hardy no. 3K303 - old style Size: 1/2 in x 3/4 in x 1/2 in Fits splice nose iron: 0525-0041, 0525-0043, 0525-0045, 0525-0047 Models: HS-1, HS-2, HS-3 Pivot | Consult |
| 0525-0508 | Equiv hardy no. 7K303 - old style Size: 1/2 in x 3/4 in x 5/8 in Fits splice nose iron: 0525-0049, 0525-0051 0525-0053, 0525-0055 Models: HS-4, HS-5, HS-6, HS-7 Pivot | Consult |
| 0525-0509 | Equiv. Hardy no. 8K303 - old style Size: 1/2 in x 3/4 in x 3/4 in Fits splice nose iron: 0525-0035, 0525-0037 Models: HS-8, HS-9 Pivot | Consult |

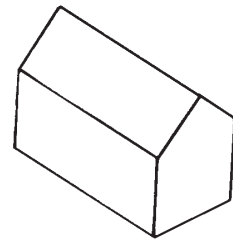
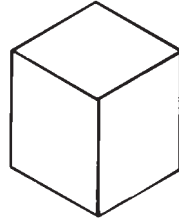

HARDY®

Individual Hardy Scale Parts

Pivots (Cont.)

| RL PN | DESCRIPTION | SUGG. LIST |
|-----------|--|------------|
| 0525-0060 | Equiv. Hardy no. 2K201 Size: 3/8 in x 3/8 in x 3 1/2 in Load and fulcrum: main lever Models: HS-1, HS-2 Pivot | Consult |
| 0525-0074 | Equiv. Hardy no. 4K201 Size: 1/2 in x 1/2 in x 3 1/2 in Load and fulcrum: main lever Models: HS-3, HS-4 Pivot | Consult |
| 0525-0075 | Equiv. Hardy no. 7K201 Size: 5/8 in x 5/8 in x 4 in Load and fulcrum: main lever Model: HS-5, HS-6, HS-7 Pivot | Consult |
| 0525-0077 | Equiv. Hardy no. 8K201 Size: 3/4 in x 3/4 in x 4 5/8 in Load and fulcrum: main lever Models: HS-8 Pivot | Consult |
| 0525-0056 | Equiv. Hardy no. 10K201 Size: 1/2 in x 3/4 in x 2 5/8 in Load and fulcrum: main lever Models: HS-9, HS-10 Pivot | Consult |
| 0525-0070 | Equiv. Hardy no. 12K201 Size: 1/2 in x 3/4 in x 3 1/4 in Load and fulcrum: main lever Models: HS-11, HS-12 Pivot | Consult |

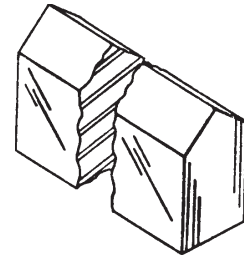
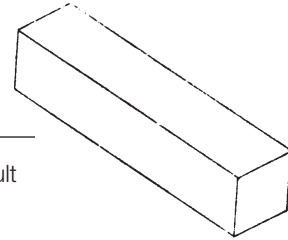

Individual Hardy Scale Parts

Loops

| RL PN | DESCRIPTION | SUGG. LIST |
|-----------|--|------------|
| 0525-0215 | Equiv. Hardy no. KX123 Size: A. 2 29/32 in B. 1 in C. 1 1/16 in Uses bearing no. 0525-0199 Loop | Consult |
| 0525-0216 | Equiv. Hardy no. KX124 Size: A. 2 29/32 in B. 1 in C. 15/16 in Uses bearing no. 0525-0196 Loop | Consult |
| 0525-0223 | Equiv. Hardy no. 13KX109 Size: A. 2 17/32 in B. 1 in C. 13/16 in Uses bearing no. 0525-0194 Loop | Consult |
| 0525-0224 | Equiv. Hardy no. 13KX110 Size: A. 1 27/32 in B. 1 in C. 13/16 in Uses bearing no. 0525-0194 Loop | Consult |
| 0525-0225 | Equiv. Hardy no. 2KX111 Size: A. 2 17/32 in B. 1 in C. 15/16 in Uses bearing no. 0525-0196 Loop | Consult |
| 0525-0226 | Equiv. Hardy no. 4KX111 Size: A. 2 17/32 in B. 1 in C. 1 1/16 in Uses bearing no. 0525-0199 Loop | Consult |
| 0525-0227 | Equiv. Hardy no. 7KX111 Size: A. 3 in B. 1 9/32 in C. 1 9/16 in Uses bearing no. 0525-0203 loop | Consult |
| 0525-0228 | Equiv. Hardy no. 8KX111 Size: A. 3 9/32 in B. 1 5/16 in C. 1 1/2 in Uses bearing no. 0525-0207 Loop | Consult |

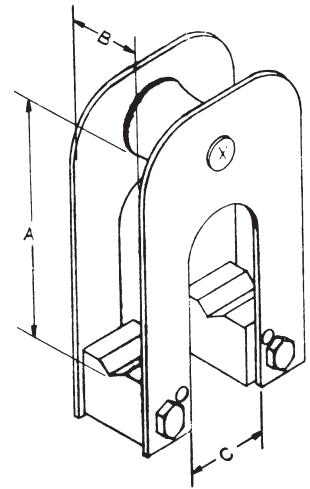

HARDY®

Individual Hardy Scale Parts

Miscellaneous

| RL PN | DESCRIPTION | SUGG. LIST |
|-----------|---|------------|
| 0525-0152 | Equiv. Hardy no. 3Kx2000 Steelyard rod dia 1/2 in Top bearing: 0525-0143 Bottom bearing: 0525-0144 Models: HS-1, HS-2, HS-3 Shackle assembly | Consult |
| 0525-0153 | Equiv. Hardy no. 4Kx2000 Steelyard rod dia 1/2 in Top bearing: 0525-0146 Bottom bearing: 0525-0147 Model: HS-4 Shackle assembly | Consult |
| 0525-0154 | Equiv. Hardy no. 5Kx2000 Steelyard rod dia 5/8 in Tip bearing: 0525-0146 Bottom bearing: 0525-0147 Model: HS-5 Shackle assembly | Consult |
| 0525-0155 | Equiv. Hardy no. 7Kx2000 Steelyard rod dia 5/8 in Top bearing: 0525-0148 Bottom bearing: 0525-0149 Models: hs-6, hs-7 Shackle assembly | Consult |
| 0525-0156 | Equiv. Hardy no. 8Kx2000 Steelyard rod dia 3/4 in Top bearing: 0525-0133 Bottom bearing: 0525-0134 Model: HS-8 Shackle assembly | Consult |
| 0525-0057 | Equiv. Hardy no. 10K311 Size: 1/4 in x 3/4 in x 1 3/4 in Models: HS-8, HS-9, HS-10 Nose iron retainer plate | Consult |
| 0525-0200 | Equiv. Hardy no. 4K1205 Size: 7/16 in O.D. x 1 in Bearing spacer | Consult |
| 0525-0204 | Equiv. Hardy no. 7K1205 Size: 9/16 in O.D. x 1 9/32 in Bearing spacer | Consult |
| 0525-0208 | Equiv. Hardy no. 8K1205 Size: 11/16 in O.D. x 1 5/16 in Bearing spacer | Consult |

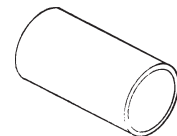
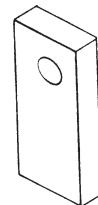
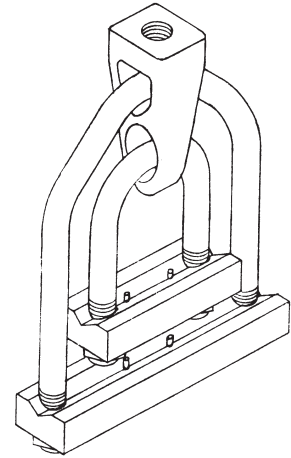

Individual Hardy Scale Parts

Miscellaneous (Cont.)

| RL PN | DESCRIPTION | SUGG. LIST |
|-------------------|--|------------|
| 13720 | Cable Size: 1/8 in dia | Consult/Ft |
| 13721 | Cable Size: 3/16 in dia | Consult/Ft |
| 0525-0035 (B) | Equiv Hardy no. 10K308 size: 3/4 in x 3 15/16 in x 8 15/16 in Uses pivot no. 0525-0064 Models: HS-8, HS-9, HS-10, R.H., nose iron | Consult |
| *0525-0037 (B) | Equiv Hardy no. 10K309 size: 3/4 in x 3 15/16 in x 8 15/16 in Uses pivot no. 0525-0064 Models: HS-8, HS-9, HS-10, I.H., nose iron | Consult |
| 0525-0045 (B) | Equiv Hardy no. 3K308 size: 1/2 in x 3 1/32 in x 8 5/16 in Uses pivot no. 0525-0061 Models: HS-3, R.H., nose iron | Consult |
| 0525-0047 (B) | Equiv Hardy no. 3K309 size: 1/2 in x 2 7/16 in x 8 5/16 in Uses pivot no. 0525-0061 Models: HS-3, I.H., nose iron | Consult |
| 0525-0049 (B) | Equiv Hardy no. 4K308 size: 5/8 in x 3 11/32 in x 8 5/16 in Use pivot no. 0525-0063 Models: HS-4, R.H., nose iron | Consult |
| 0525-0051 (B) | Equiv Hardy no. 4K309 size: 5/8 in x 2 7/16 in x 8 5/16 in Uses pivot no. 0525-0063 Models: HS-4, I.H., nose iron | Consult |
| 0525-0053 (B) | Equiv Hardy no. 7K308 size: 5/8 in x 2 15/16 in x 8 5/16 in Use pivot no. 0525-0063 Models: HS-5, HS-6, HS-7, R.H., nose iron | Consult |
| 0525-0055 (B) | Equiv Hardy no. 7K309 size: 5/8 in x 2 15/16 in x 8 5/16 in Use pivot no. 0525-0063 Models: HS-5, HS-6, HS-7, I.H., nose iron | Consult |

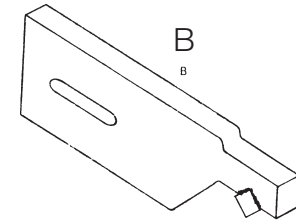
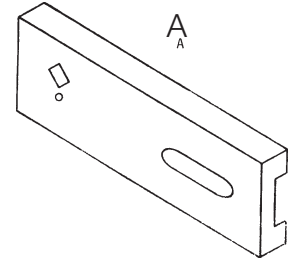

HARDY®

HARDY KITS

HARDY®

Hardy Kit Price Index By Rice Lake PN

| RL PN | SUGGESTED LIST | PAGE # | RL PN | SUGGESTED LIST | PAGE # | RL PN | SUGGESTED LIST | PAGE # |
|----------|----------------|--------|----------|----------------|--------|----------|----------------|--------|
| HS-101-K | CONSULT | 279 | HS-106-K | CONSULT | 281 | HS-204-K | CONSULT | 280 |
| HS-103-K | CONSULT | 279 | HS-108-K | CONSULT | 281 | HS-205-K | CONSULT | 280 |
| HS-104-K | CONSULT | 280 | HS-203-K | CONSULT | 279 | HS-206-K | CONSULT | 281 |
| HS-105-K | CONSULT | 280 | | | | HS-208-K | | 281 |

*Item obsolete or discontinued. When remaining stock is depleted, published prices are withdrawn and the item is subject to a special order quote.

XX Call for details.

Hardy Kit Reference By Capacity

| Pivot and Bearing Kits | | | Kits With Complete Assemblies | | |
|------------------------|----------|--------|-------------------------------|----------|--------|
| CAPACITY (LB) | RL PN | PAGE # | CAPACITY (LB) | RL PN | PAGE # |
| 0-1,250 | HS-101-K | 279 | 0-1,250 | HS-201-K | XX |
| 1,251-2,500 | HS-103-K | 279 | 1,251-2,500 | HS-203-K | 279 |
| 2,501-6,250 | HS-104-K | 280 | 2,501-6,250 | HS-204-K | 280 |
| 6,251-7,500 | HS-105-K | 280 | 6,251-7,500 | HS-205-K | 280 |
| 7,501-12,500 | HS-106-K | 281 | 7,501-12,500 | HS-206-K | 281 |
| 12,501-25,000 | HS-108-K | 281 | 12,501-25,000 | HS-208-K | 281 |
| 25,001-37,500 | HS-109-K | XX | 25,001-37,500 | HS-209-K | XX |

*Item obsolete or discontinued. When remaining stock is depleted, published prices are withdrawn and the item is subject to a special order quote.

XX Call for details.

Hopper Scale

Kit No. HS-101-K

Pivots and Bearings Only For The Main Levers, Models HS-1 and HS-2, 0-1, 250 lb Capacity

| QTY | RL PN | DESCRIPTION |
|---------|----------------|--------------------------------------|
| 16..... | 0525-0196..... | Bearing, main lever load and fulcrum |
| 16..... | 0525-0200..... | Bearing, spacer |
| 8..... | 0525-0060..... | Pivot, main lever load and fulcrum |
| 2..... | 0525-0061..... | Pivot, main lever tip (new style) |
| 2..... | 0525-0507..... | Pivot, main lever tip |
| 1..... | 0525-0143..... | Bearing, top of splice shackle |
| 1..... | 0525-0144..... | Bearing, bottom of splice shackle |

Consult Suggested list/5 lb shipping weight

Kit No. HS-103-K

Pivots and Bearings Only For The Main Levers Model HS-3, 1, 251-2, 500 lb Capacity

| QTY | RL PN | DESCRIPTION |
|---------|----------------|--------------------------------------|
| 16..... | 0525-0199..... | Bearing, main lever load and fulcrum |
| 16..... | 0525-0200..... | Bearing, spacer |
| 8..... | 0525-0074..... | Pivot, main lever load and fulcrum |
| 2..... | 0525-0061..... | Pivot, main lever tip (new style) |
| 2..... | 0525-0507..... | Pivot, main lever tip |
| 1..... | 0525-0143..... | Bearing, top of splice shackle |
| 1..... | 0525-0144..... | Bearing, bottom of splice shackle |

Consult Suggested list/7 lb shipping weight

Kit No. HS-203-K

This Kit Fits The Main Levers Model HS-3, 1, 251-2, 500 lb Capacity But Has Complete Assemblies

| QTY | RL PN | DESCRIPTION |
|--------|----------------|----------------------|
| 8..... | 0525-0226..... | Loop, main lever |
| 8..... | 0525-0074..... | Pivot, main lever |
| 1..... | 0525-0045..... | Pivot with nose iron |
| 1..... | 0525-0047..... | Pivot with nose iron |
| 1..... | 0525-0152..... | Shackle assembly |

Consult Suggested list/18 lb shipping weight

HARDY® KITS

Hopper Scale

Kit No. HS-104-K

Pivots and Bearings Only For The Main Levers Model HS-4, 2, 501-6, 250 lb Capacity

| QTY | RL PN | DESCRIPTION |
|---------|----------------|--------------------------------------|
| 16..... | 0525-0199..... | Bearing, main lever load and fulcrum |
| 16..... | 0525-0200..... | Bearing, spacer |
| 8..... | 0525-0074..... | Pivot, main lever load and fulcrum |
| 2..... | 0525-0063..... | Pivot, main lever tip (new style) |
| 2..... | 0525-0508..... | Pivot, main lever tip |
| 1..... | 0525-0146..... | Bearing, top of splice shackle |
| 1..... | 0525-0147..... | Bearing, bottom of splice shackle |

Consult Suggested list/6 lb shipping weight

Kit No. HS-204-K

This Kit Fits The Main Lever Model HS-4, 2, 501-6, 250 lb Capacity Scale But Has Complete Assemblies

| QTY | RL PN | DESCRIPTION |
|--------|----------------|------------------------------------|
| 8..... | 0525-0226..... | Loop, main lever |
| 8..... | 0525-0074..... | Pivot, main lever load and fulcrum |
| 1..... | 0525-0049..... | Pivot with nose iron, r.H. |
| 1..... | 0525-0051..... | Pivot with nose iron, l.H. |
| 1..... | 0525-0153..... | Shackle assembly |

Consult Suggested list/21 lb shipping weight

Kit No. HS-105-K

Pivots and Bearings Only For The Main Levers Model HS-5, 6, 251-7, 500 lb Capacity

| QTY | RL PN | DESCRIPTION |
|---------|----------------|--------------------------------------|
| 16..... | 0525-0203..... | Bearing, main lever load and fulcrum |
| 16..... | 0525-0204..... | Bearing, spacer |
| 8..... | 0525-0075..... | Pivot, main lever load and fulcrum |
| 2..... | 0525-0063..... | Pivot, main lever tip (new style) |
| 2..... | 0525-0508..... | Pivot, main lever tip |
| 1..... | 0525-0146..... | Bearing, top of splice shackle |
| 1..... | 0525-0147..... | Bearing, bottom of splice shackle |

Consult Suggested list/11 lb shipping weight

Kit No. HS-205-K

This Kit Fits The The Main Levers Model HS-5, 6, 251-7, 500 lb Capacity But Has Complete Assemblies

| QTY | RL PN | DESCRIPTION |
|--------|----------------|------------------------------------|
| 8..... | 0525-0227..... | Loop, main lever load and fulcrum |
| 8..... | 0525-0075..... | Pivot, main lever load and fulcrum |
| 1..... | 0525-0053..... | Pivot with nose iron, R.H. |
| 1..... | 0525-0055..... | Pivot with nose iron, l.H. |
| 1..... | 0525-0154..... | Shackle assembly |

Consult Suggested list/37 lb shipping weight

Hopper Scale

Kit No. HS-106-K

Pivots and Bearings Only For The Main Levers, Models HS-6 and HS-7, 7, 501-12, 500 lb Capacity

| QTY | RL PN | DESCRIPTION |
|---------|----------------|--------------------------------------|
| 16..... | 0525-0203..... | Bearing, main lever load and fulcrum |
| 16..... | 0525-0204..... | Bearing, spacer |
| 8..... | 0525-0075..... | Pivot, main lever load and fulcrum |
| 2..... | 0525-0063..... | Pivot, main lever tip (new style) |
| 2..... | 0525-0508..... | Pivot, main lever tip |
| 1..... | 0525-0148..... | Bearing, top of splice shackle |
| 1..... | 0525-0149..... | Bearing, bottom of splice shackle |

Consult Suggested list/12 lb shipping weight

Kit No. HS-206-K

This Kit Fits The Main Levers, Models HS-6 and HS-7, 7, 501-12, 500 lb Capacity But Has Complete Assemblies

| QTY | RL PN | DESCRIPTION |
|--------|----------------|------------------------------------|
| 8..... | 0525-0227..... | Loop, main lever load and fulcrum |
| 8..... | 0525-0075..... | Pivot, main lever load and fulcrum |
| 1..... | 0525-0053..... | Pivot with nose iron, R.H. |
| 1..... | 0525-0055..... | Pivot with nose iron, I.H. |
| 1..... | 0525-0155..... | Shackle assembly |

Consult Suggested list/39 lb shipping weight

Kit No. HS-108-K

Pivots and Bearings For The Main Levers, Models HS-8, 12, 501-25,000 lb Capacity

| QTY | RL PN | DESCRIPTION |
|---------|----------------|--------------------------------------|
| 16..... | 0525-0207..... | Bearing, main lever load and fulcrum |
| 16..... | 0525-0208..... | Bearing, spacer |
| 8..... | 0525-0077..... | Pivot, main lever load and fulcrum |
| 2..... | 0525-0064..... | Pivot, main lever tip (new style) |
| 2..... | 0525-0509..... | Pivot, main lever tip |
| 1..... | 0525-0133..... | Bearing, top of splice shackle |
| 1..... | 0525-0134..... | Bearing, bottom of splice shackle |

Consult Suggested list/18 lb shipping weight

Kit No. HS-208-K

This Kit Fits The Main Levers, Models HS-8, 12, 501-25,000 lb Capacity But Has Complete Assemblies

| QTY | RL PN | DESCRIPTION |
|--------|----------------|------------------------------------|
| 8..... | 0525-0228..... | Loop, main lever load and fulcrum |
| 8..... | 0525-0077..... | Pivot, main lever load and fulcrum |
| 1..... | 0525-0035..... | Pivot with nose iron, R.H. |
| 1..... | 0525-0037..... | Pivot with nose iron, I.H. |
| 1..... | 0525-0156..... | Shackle assembly |

Suggested list/64 lb shipping weight

HARDY® KITS

