

MSI Dyna-Clamp

Tension Meter

Operation Manual



An ISO 9001 registered company
© Rice Lake Weighing Systems. All rights reserved.

Rice Lake Weighing Systems® is a registered trademark of
Rice Lake Weighing Systems.
All other brand or product names within this publication are trademarks or
registered trademarks of their respective companies.

All information contained within this publication is, to the best of our knowledge, complete and accurate at the time of publication. Rice Lake Weighing Systems reserves the right to make changes to the technology, features, specifications and design of the equipment without notice.

The most current version of this publication, software, firmware and all other product updates can be found on our website:

www.ricelake.com

Contents

1.0 Introduction	1
1.1 Safety	1
1.2 Display	2
2.0 Operation	3
2.1 Unpacking	3
2.1.1 Battery Installation	3
2.2 Product Dimensions	3
2.3 Power	3
2.4 Wire Rope Selection	3
2.5 Zero	4
2.6 Tension Measurement	4
2.7 Average Function	5
2.7.1 Average Procedure	5
2.7.2 Clearing Average	5
2.8 Peak Function	5
2.8.1 Clearing Peak	5
2.9 Safety Strap	5
2.10 Carry Case Option	5
3.0 Configuration	6
3.1 General Navigation	6
3.2 Setup Menu	6
3.3 Function Keys	7
3.3.1 Off	7
3.3.2 Test	7
3.3.3 Unit	7
3.3.4 Scroll	7
3.3.5 Active Function	7
3.4 Auto-Off	8
3.5 Range	8
3.5.1 Number Entry	8
3.6 Filter	9
3.7 Units	9
3.8 Battery Life	10
4.0 Troubleshooting and Maintenance	11
4.1 Troubleshooting	11
4.1.1 Error Codes	12
4.2 Battery Replacement	12
4.2.1 Disposable Batteries	12
4.2.2 Rechargeable Batteries	12
4.3 Drive Rod Lubrication	13
4.4 Bobbin Replacement	13
5.0 Specifications	14



Technical training seminars are available through Rice Lake Weighing Systems. Course descriptions and dates can be viewed at www.ricelake.com/training or obtained by calling 715-234-9171 and asking for the training department.



Rice Lake continually offers web-based video training on a growing selection of product-related topics at no cost. Visit www.ricelake.com/webinars

1.0 Introduction

The Dyna-Clamp is a reliable, accurate, easy to operate tension meter that is sealed for outdoor use. The two line LCD display allows for selecting the correct wire rope diameter and displaying the current wire rope tension. The Dyna-Clamp is factory calibrated for up to eight wire rope diameters.



Manuals and additional resources are available from Rice Lake Weighing Systems at www.ricelake.com/manuals

Warranty information can be found on the website at www.ricelake.com/warranties

1.1 Safety

Safety Signal Definitions:



DANGER Indicates an imminently hazardous situation that, if not avoided, will result in death or serious injury. Includes hazards that are exposed when guards are removed.



WARNING Indicates a potentially hazardous situation that, if not avoided, could result in serious injury or death. Includes hazards that are exposed when guards are removed.



CAUTION Indicates a potentially hazardous situation that, if not avoided, could result in minor or moderate injury.



IMPORTANT Indicates information about procedures that, if not observed, could result in damage to equipment or corruption to and loss of data.

General Safety



Do not operate or work on this equipment unless this manual has been read and all instructions are understood. Failure to follow the instructions or heed the warnings could result in injury or death. Contact any Rice Lake Weighing Systems dealer for replacement manuals.



Failure to heed could result in serious injury or death.

Do not allow minors (children) or inexperienced persons to operate this unit.

Do not use for purposes other than measuring the tension of a wire rope.

Do not use any load bearing component that is worn beyond 5% of the original dimension.

Do not use the tension meter if any of the components of the load train are cracked, deformed, or show signs of fatigue.

Do not exceed the rated load limit of the tension meter.

Do not use the tension meter on wire rope diameters over 1".

Do not make alterations or modifications to the tension meter.

Do not remove or obscure warning labels.

Replace labels when worn. Contact Rice Lake Weighing Systems for replacement labels.

Keep hands, feet and loose clothing away from moving parts and pinch points.

Repairs must be performed by qualified service personnel only.

IMPORTANT

Failure to heed could result in equipment damage and will void the warranty.

Do not over tighten the drive rod. Over tightening could cause damage to the wire rope or the Dyna-Clamp.

Regularly apply moly grease to the drive rod threads to maintain proper lubrication to avoid premature wear and damage.

Remove the batteries prior to storing if the Dyna-Clamp is not going to be used for an extended period of time.

Do not use solvents or aggressive substances to clean the Dyna-Clamp.

Do not submerge.

1.2 Display

The front panel consists of a two-line, LCD display with four LED annunciators and four keys. This section provides a detailed description of what is featured on the display and the key functions.

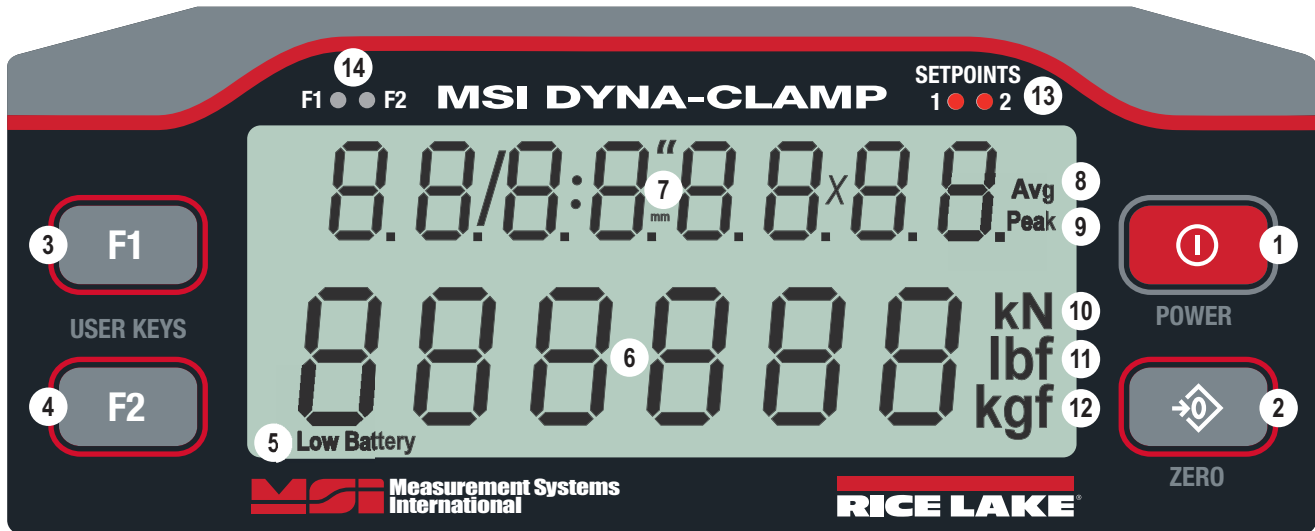

Figure 1-1. Dyna-Clamp Front Panel

Item No.	Description
1	Power Key – powers the Dyna-Clamp on and off; in setup mode, it returns the unit to tension display without saving settings
2	Zero Key– zeros out the residual tension on the link; in setup mode, it saves settings and drops back one menu level
3	F1 Key – programmable to user functions (Section 3.3 on page 7); default function is Active Function (RctFun)
4	F2 Key – programmable to user functions (Section 3.3 on page 7); default function is Scroll (ScroLL)
5	Low Battery – displays when approximately 10% of battery life remains and blinks when automatic shutdown is imminent
6	Primary display with six 0.7" (18 mm) numeric digits; displays live wire rope tension and is sunlight visible
7	Secondary display with eight 0.5" (13mm) numeric digits; displays wire rope diameter, average tension and peak tension
8	Average Function – indicates the average function is currently displaying on the secondary (top) display line; displays the running average tension measurement (Section 2.7 on page 5)
9	Peak Function – indicates the peak function is currently displaying on the secondary (top) display line; displays the greatest tension that has been measured (Section 2.8 on page 5)
10	Kilonewton – indicates the tension display is in kilonewtons
11	Pound-force – indicates the tension display is in pounds
12	Kilogram-force – indicates the tension display is in kilograms
13	Setpoint/Range LEDs – indicates if tension measurements are outside of the programmable range
14	F-Key LEDs – not currently supported

Table 1-1. Key Descriptions

Wire Rope Examples:

Below are two examples of how wire rope types appear on the Dyna-Clamp display. The diameter of the wire rope type displays first, followed by the wire rope class.

0 3/0 4" 0 6 x 3 6

Wire Rope Diameter = 3/4" | Wire Rope Class = 6 x 36

0 1/0 2" 0 8 x 1 9

Wire Rope Diameter = 1/2" | Wire Rope Class = 8 x 19

2.0 Operation

This section includes the basic operation procedures to get the Dyna-Clamp working out of the box.

2.1 Unpacking

Immediately after unpacking the Dyna-Clamp from the shipping container, visually inspect the product to ensure all components are included and undamaged. If parts were damaged in shipment, notify Rice Lake Weighing Systems and the shipper immediately. Retain the shipping container for future shipping or transporting of the unit.

2.1.1 Battery Installation

Batteries do not come pre-installed in the Dyna-Clamp. See [Section 4.2 on page 12](#) for initial installation of the two (2) included AA cell 1.5 V alkaline batteries.

IMPORTANT

Remove the batteries prior to storing to prevent possible battery corrosion if the Dyna-Clamp is not going to be used for an extended period of time.

2.2 Product Dimensions

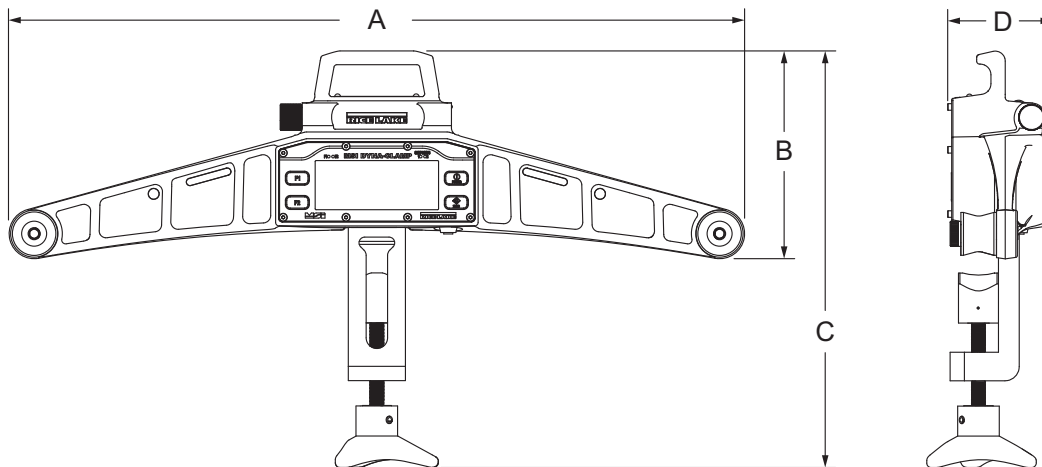



Figure 2-1. Product Diagram

A	B	C	D
25.7" (652.8 mm)	7.3" (185.5 mm)	13.75–15.5" (349.3–393.7 mm)	3.7" (94.0 mm)

Table 2-1. Product Dimensions

2.3 Power

Press  to turn on the Dyna-Clamp. The startup sequence displays all LCD segments, followed briefly by the software version number and the battery volt level. After the startup sequence is complete, the primary display area of the Dyna-Clamp enters tension mode.

2.4 Wire Rope Selection

Press  (RctFun by default) with the current wire rope value displaying in the secondary display area to toggle through the available wire rope options. The wire rope selection needs to be made before Zeroing the Dyna-Clamp.



The F1-key is setup as Active Function (RctFun) by default. See [Section 3.3 on page 7](#) to program the function keys.

The F2-key is setup as Scroll (ScroLL) by default and scrolls through the secondary (top) display area options.

The Dyna-Clamp is factory calibrated for up to eight (8) wire rope diameters. Calibrations may only be performed by Rice Lake Weighing Systems. Please contact Rice Lake Weighing Systems for calibration assistance or if additional wire rope calibrations are required.

2.5 Zero

Press  when the Dyna-Clamp is not under tension to remove small deviations of the zero reading. Zero on location, just prior to positioning the Dyna-Clamp on the wire rope. Re-zero the Dyna-Clamp each time the wire rope selection is changed.



Note

The Dyna-Clamp must be held horizontally by the carrying handle. The load cell mount assembly must be fully suspended and not in contact with any surrounding surfaces or objects before pressing . The unloaded indication on the display will vary slightly depending on orientation. This variation is negated once under tension.

2.6 Tension Measurement

The following procedure describes how to connect the Dyna-Clamp to a wire rope to take a tension reading. The Dyna-Clamp can be used to monitor the tension of a wire rope for maintenance and installation applications.

IMPORTANT

Always ensure that the wire rope is centered on both bobbins and never use the Dyna-Clamp on a wire rope diameter over 1". Regularly apply moly grease to the drive rod threads to maintain proper lubrication.

1. Loosen the drive rod.
2. Zero the Dyna-Clamp ([Section 2.5](#)).

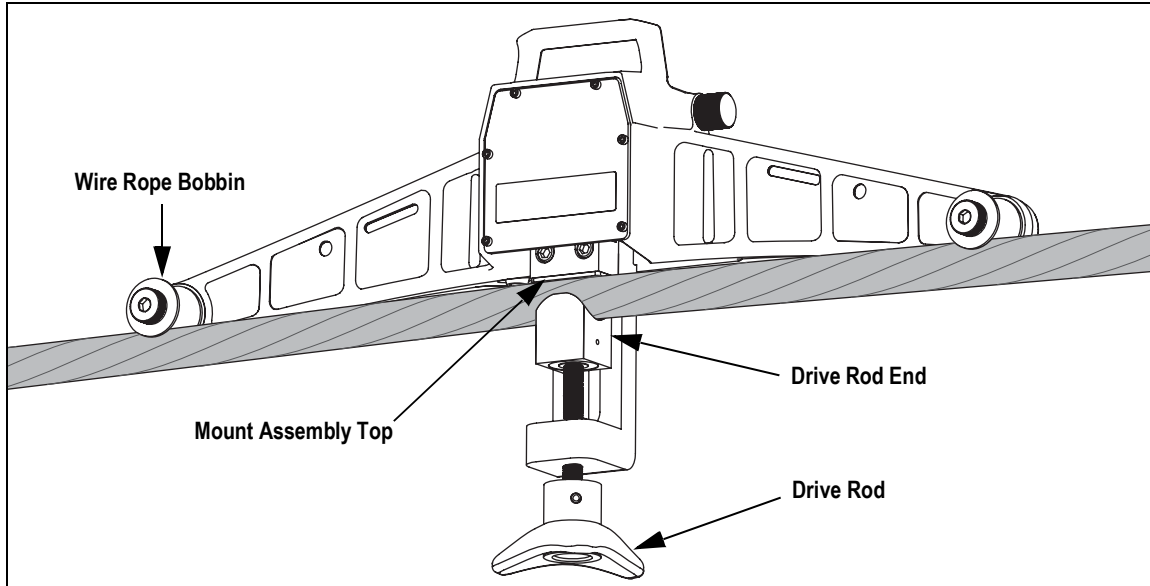

Figure 2-2. Dyna-Clamp On Wire Rope

3. Position the Dyna-Clamp on the wire rope ([Figure 2-2](#)).



Note

Position Dyna-Clamp directly to the wire rope, at least two feet from any attachments or the termination points.

4. Roll the Dyna-Clamp 6-8" back and forth along the wire rope to align the unit to the center of the wire rope.
5. Tighten the drive rod assembly firmly, torquing the drive rod to approximately 60-100 in-lb. Drive rod assembly should be tightened until the rope contacts the stop block and the handle becomes hand tight; be careful not to "crush" the rope by over-tightening. The optimal torque rating varies depending on the wire rope diameter and construction.

IMPORTANT

Do not over tighten the drive rod. Over tightening could cause damage to the wire rope or the Dyna-Clamp.

6. Take the tension reading from display. See [Section 2.7 on page 5](#) for how to use the Average Function.
7. Loosen the drive rod assembly and remove the Dyna-Clamp from the wire rope.
8. Repeat [Steps 3-7](#) to take additional tension measurements as needed. For the best accuracy take at least three tension readings at slightly different locations along the wire rope using the Average Function ([Section 2.7 on page 5](#)).

2.7 Average Function

The average function allows the operator to combine multiple tension measurements and displays the average in the secondary (top) display area.



Note

The following procedures assume that the F-Keys are still programmed to the default settings with **F1** set to **RctFun** and **F2** set to **ScroLL**. See [Section 3.3 on page 7](#) to program the F-Keys.

2.7.1 Average Procedure

Follow this procedure to utilize the average function:

1. Press **F2** until **Avg** displays to the right side of the secondary display area.
2. Position the Dyna-Clamp on the wire rope and allow a few seconds for a stable reading.
3. Press **F1**. This takes the current display value to be included into the running average.
4. Remove the Dyna-Clamp from the wire rope. Additional values can not be added to the running average until the Dyna-Clamp has been removed from the wire rope and the live tension reading passes below a low % of capacity. This is by design to prevent averaging the same load more than once.
5. Repeat [Steps 2-4](#) as needed.

2.7.2 Clearing Average

Follow this procedure when the running average needs to be cleared:

1. Position the Dyna-Clamp on the wire rope and tighten slightly, so a little positive tension is measured by the device.
2. Press **F1**, followed quickly with pressing **ZERO** to clear the current average register.
3. Remove the Dyna-Clamp from the wire rope and re-zero ([Section 2.5 on page 4](#)).

2.8 Peak Function

The purpose of the peak function is to take and record the greatest tension that is applied. Press the **ScroLL** F-Key until **Peak** displays to the right side of the secondary display area. As long as **Peak** is displayed, the secondary display area continuously displays the greatest tension that has been measured.

2.8.1 Clearing Peak

Press **F1** (**RctFun** by default) with the peak value displaying in the secondary display area to reset the peak function.



Note

Changing from one wire rope setting to another will automatically clear both the average and peak values.

2.9 Safety Strap

The Dyna-Clamp has a slot and hole on either side of the display to accommodate the attachment of a safety strap.

2.10 Carry Case Option

A hard-sided carry case (PN 198418) is available as an option to provide more protection and security when transporting the Dyna-Clamp tension meter.

3.0 Configuration

This section describes parameter settings on the Dyna-Clamp. The Dyna-Clamp is factory calibrated for up to eight wire rope diameters. Calibrations may only be performed by Rice Lake Weighing Systems. Please contact Rice Lake Weighing Systems for calibration assistance or if additional wire rope calibrations are required.

3.1 General Navigation

Use the following keys for navigating through the menus when setting up the Dyna-Clamp:

- Press **F2** to scroll through the parameters or settings
- Press **F1** to enter a selected parameter or to save a selection and return to previous menu
- Press **ZERO** to save a setting and return to previous menu or to tension mode (*StorE* displays)
- Press **POWER** to return to tension mode without saving settings (*CLAMP* displays)

3.2 Setup Menu

To enter the setup menu, press **POWER** and **F2** at the same time.

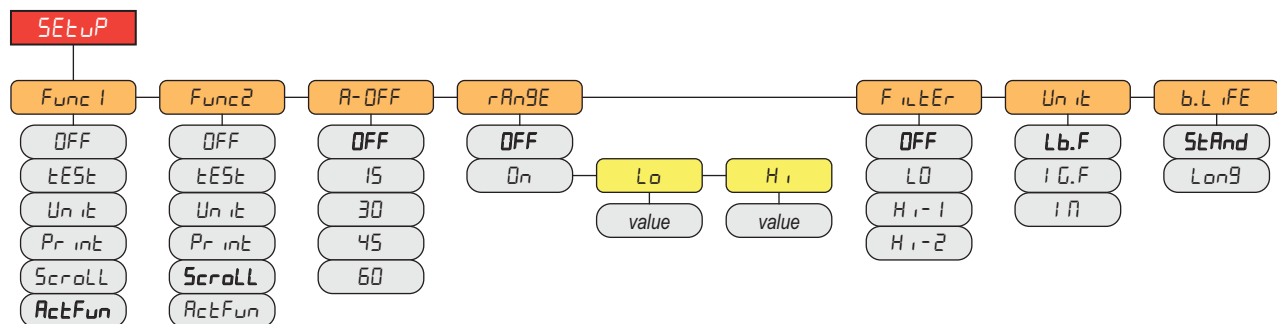

Figure 3-1. Setup Menu

Parameter	Description
Func1 Func2	F1 key – configurable to listed parameters; ActFun (default) F2 key – configurable to listed parameters; Scroll (default) <ul style="list-style-type: none"> • Off – key is disabled • Test – runs display and system test (Section 3.3.2 on page 7) • Unit – ability to change between available units lbf, kgf and kN (Section 3.3.3 on page 7) • Print – not currently implemented • Scroll – scrolls through the available wire rope types and the average and peak values in the secondary (top) display area (Section 3.3.4 on page 7) • ActFun – performs action based on the active function that is displayed in the secondary (top) display; adds an additional value for average or clears the current peak value (Section 3.3.5 on page 7)
A-OFF	Auto-Off – sets the amount of standstill time (in minutes) before the Dyna-Clamp automatically turns off (Section 3.4 on page 8); settings: Off (default), 15, 30, 45, 60
Range	Range – sets a low (Lo) and high (Hi) setpoint value; provides an indication of when the tension measurement is within this specified range (Section 3.5 on page 8); settings: <ul style="list-style-type: none"> • Off – indicates setpoints are disabled • On – indicates setpoints are enabled • Lo – prompts user to enter setpoint value for low range setpoint • Hi – prompts user to enter setpoint value for high range setpoint
Filter	Tension Filter – allows the scale to adjust to situations where there may be movement or vibration (Section 3.8 on page 10); settings: Off, LO, Hr-1, Hr-2
Unit	Tension Units – sets the units displayed (Section 3.7 on page 9); settings: Lb.F (lbf), I G.F (kgf), IN (kN)
b.Life	Battery Life – sets the options for standard or extended battery life (Section 3.8 on page 10); settings: Stand, Long

Table 3-1. Setup Menu Parameter Descriptions

3.3 Function Keys

There are two function keys, **F1** and **F2** on the front panel of the Dyna-Clamp. The F-keys can be programmed to several different functions.

To assign a function to an F-key:

1. Press **POWER** and **F2** simultaneously to enter the setup menu. *F_{UNC 1}* displays.
2. Press **F1** to enter the setup of the F1 key.
3. Press **F2** to scroll through the available settings.
4. Press **F1** to select the desired setting and return to the setup menu. *F_{UNC 2}* displays.
5. Repeat [Step 2](#) through [Step 6](#) for the F2 key if needed.
6. Press **ZERO** to save. *SAVE* displays briefly and the Dyna-Clamp returns to tension mode.

3.3.1 Off

When an F-Key is set to *OFF*, the F-Key is disabled.

3.3.2 Test

See [Section 3.3](#) to set an F-Key as *TEST*. When an F-Key is set to *TEST*, pressing the F-Key prompts the display to scroll through the following:

- Lights all LCD segments and the LEDs
- *Soft* followed by the version number
- *Batt* followed by the battery level in volts
- *d. TEST* followed by counting from 0.0.0.0.0 to 9.9.9.9.9
- *C-CAL* followed by the c-cal value displaying in the secondary display area

The test can be single stepped:

1. Press F-key set to *TEST*, then immediately press **F2** to stop the auto scroll.
2. Press **F2** to scroll through each step and press **F1** to view the step value.
3. Press **ZERO** to stop the test.

IMPORTANT

Internal tests are also performed and if the test fails, an error code displays ([Section 4.1.1 on page 12](#)).

3.3.3 Unit

See [Section 3.3](#) to set an F-Key as *Unit*. When an F-Key is set to *Unit*, pressing the F-Key scrolls through the available unit options: lbf, kgf, and kN.

3.3.4 Scroll

See [Section 3.3](#) to set an F-Key as *Scroll*. When an F-Key is set to *Scroll*, pressing the F-Key scrolls through the secondary (top) display area options, which include available wire rope types, the average value and the peak value. The F2-key is setup as Scroll (*Scroll*) by default.

3.3.5 Active Function







See [Section 3.3](#) to set an F-Key as *Active Function*. When an F-Key is set to *Active Function*, pressing the F-Key performs an action based on the active function that is displayed in the secondary (top) display area. If the average function is displayed, then *Active Function* adds an additional value to the average. If peak function is displayed, then *Active Function* clears the current peak value. The F1-key is setup as Active Function (*Active Function*) by default.

3.4 Auto-Off

The Auto-Off feature prolongs the life of the battery by turning power off when Dyna-Clamp is not in use. A key press or detected tension in motion exceeding 10 d, resets the Auto-Off time count.

When set to *OFF*, the Dyna-Clamp only turns off by pressing  or if the battery is depleted.











Use the following steps to set the Auto-Off parameter:

1. Press  and  simultaneously to enter setup menu. *FUNC 1* displays.
2. Press  to scroll to *R- OFF*.
3. Press . The current auto-off setting displays.
4. Press  to scroll to the desired time (in minutes).
5. Press  to accept the desired time setting. *RRGE* displays.
6. Press  to save and return to tension mode.

3.5 Range





The purpose of Range is to provide an indication of when the tension measurement is within a specified range. Range consists of a low and high setpoint value. If the tension is below the low setpoint value (*L 0*), then the setpoint 1 LED turns on. If the tension is above the high setpoint value (*H 1*), then the setpoint 2 LED turns on. If the tension measurement is within the specified range, then neither setpoint LED is on.

Use the following steps to set the Range setpoint values:

1. Press  and  simultaneously to enter the setup menu. *FUNC 1* displays.
 2. Press  until *RRGE* displays.
 3. Press . The current setting flashes in the secondary (top) display area.
 4. Press  to toggle from *OFF* to *ON*.
 5. Press  with *ON* flashing. *L 0* displays with the current value flashing in the secondary display area.
 6. Press  to accept the current value.
- OR -
- Press  to enter a new value. See [Section 3.5.1](#) for the number entry procedure.
- Press  to save the new value. *H 1* displays with current value flashing in the secondary display area.
7. Repeat [Step 6](#) for *H 1* setpoint value.
 8. Press  to save and return to tension mode.

3.5.1 Number Entry

Use the following keys to enter a number value:

- Press  to increment the number value of the flashing digit or to add an additional digit
- Press  to select the number value of the flashing digit or to save value when no digits are flashing
- Press  to add a decimal point after the last digit displayed
- Press  to clear the last made selection







3.6 Filter

Change the filter settings to adjust to situations where vibration in the wire rope or the structure. If the reading is not stable, it can be improved by increasing the filter setting. Settling time is longer when the filter setting is increased. The Dyna-Clamp uses algorithms that speed up large tension changes while still controlling vibration even with higher filter settings.

Parameter	Description
Off	Disables filtering function
Lo	Low Filter
Hi-1	High Filter
Hi-2	Very High Filter







Table 3-2. Filter Settings

Use the following steps to set the Filter parameter:

1. Press  and  simultaneously to enter setup menu. *FUNC 1* displays.
2. Press  to scroll to *FILTER*.
3. Press . The current setting flashes in the secondary (top) display area.
4. Press  to scroll through the available filter settings.
5. With desired filter displayed, press  to accept. *UNIT* displays.
6. Press  to save and return to tension mode.

3.7 Units

Units can be changed in two ways. By programming an F-key to *UNIT* ([Section 3.3 on page 7](#)) or by changing the units within the setup menu using the following procedure:

1. Press  and  simultaneously to enter setup menu. *FUNC 1* displays.
2. Press  to scroll to *UNIT*.
3. Press . The current setting flashes in the secondary (top) display area.
4. Press  to scroll through the available units.
5. With desired unit displayed, press  to accept. *BLIFE* displays.
6. Press  to save and return to tension mode.

3.8 Battery Life







The battery life parameter (bL_{iFE}) offers a standard mode ($StAnd$) and a long battery life mode ($LoNg$). When in the long battery life mode, the system is placed into a sleep state if there is no change in tension after a period of time. This disables the display in order to reduce power consumption and increase the battery life. The unit does not enter the sleep state if it is in the setup menu. The auto-off parameter (Section 3.4 on page 8) also conserves battery life by turning the unit off if no activity is sensed for a set time.



Note

The standard mode ($StAnd$) is recommended for best performance. Long battery life mode ($LoNg$) does not affect accuracy, but may impact performance and usability.

To set battery life mode:

1. Press  and  simultaneously to enter setup menu. F_{unc} 1 displays.
2. Press  to scroll to bL_{iFE} .
3. Press . The current setting flashes in the secondary (top) display area.
4. Press  to toggle between $StAnd$ and $LoNg$.
5. With desired unit displayed, press  to accept. F_{unc} 1 displays.
6. Press  to save and return to tension mode.

4.0 Troubleshooting and Maintenance

4.1 Troubleshooting

Problem	Possible Cause	Solution
Display is blank when POWER key is pressed	Discharged battery	Replace cells, or if using NiMH, recharge
	Defective battery	Replace
	Corroded battery or battery contacts	Clean contacts
	Defective switch or circuit board	Requires authorized service
Display does not function properly or front panel keys do not function normally or Dyna-Clamp not powering off	Improperly loaded software	Reinstall software
	Faulty circuit board	Requires authorized service
	Loose connectors	Requires authorized service
Dyna-Clamp does not respond to tension changes	Out of calibration	Requires authorized service
	Faulty load cell	Requires authorized service
	Worn out or damaged drive rod	Requires authorized service
Display over ranges below 100% of capacity	Zero requires adjustment	Rezero the Dyna-Clamp
	Too much tension/load has been zeroed	Rezero the Dyna-Clamp
Display drifts	AZM (Auto0) is turned off	Turn AZM on
	Rapid temperature changes such as moving the Dyna-Clamp from indoors to outdoors	Wait until the Dyna-Clamp temperature has stabilized
Displayed tension shows larger error	Dyna-Clamp not zeroed before load is lifted	Zero the Dyna-Clamp with no load attached
	lbf/kgf/kN units causing confusion	Select proper units
	Requires recalibration	Requires authorized service
Display reading not stable	Excessive vibration in wire rope	Increase filtering
	Load cell faulty	Check LC connections
Display toggles between Error and Load	Tension exceeds capacity	Immediately reduce tension
	Faulty load cell or wiring	Check LC and LC wiring
Display toggles between Error and Key	A key is stuck or is being held down	Check switches for damage
		Ensure that a remote is not continuously transmitting
Low battery is blinking	Battery is low	Replace (alkaline) or recharge batteries
Unit turns on then immediately off	Battery is low	Replace (alkaline) or recharge batteries
Tension does not zero	System not stable	Wait for standstill annunciator to turn on
		Increase filtering for more stability
Tension does not average	Zero out of range	Zero range might be limited; only zero while Dyna-Clamp is not clamped to a wire rope
		System is not stable
Tension does not average	System is not stable	Wait for standstill annunciator to turn on, or see Display reading not stable above for an additional solution
		Low threshold % of capacity not met between average measurements
Setpoint LEDs blink	Range is enabled and a trigger point has been reached	Disable range if it is not needed

Table 4-1. Troubleshooting

4.1.1 Error Codes

The ScaleCore processor of the Dyna-Clamp detects errors and generates error codes to aid in troubleshooting.

Error Code	Description
LCOFF	LC Disabled – A load cell was not enabled
UnCAL	Not Calibrated – System has not been calibrated
OverLoad Error	Overload – Tension exceeds set capacity +8 d; load Cell damaged or disconnected
UnLoad Error	Underload – Tension is more than 10% negative; load cell damaged or disconnected

Table 4-2. Error Codes

4.2 Battery Replacement

1. Unscrew the battery cover on the side of the handle.
2. Insert two AA batteries positive end first (can be replaced with rechargeable NiMH cells).
3. Reinstall the battery cover securely.

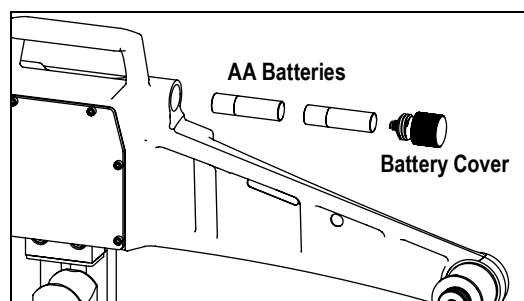

Figure 4-1. Battery Installation

Part No.	Description	Qty
191147	Battery Cap Assembly	1
16431	AA Cell 1.5 V Alkaline Battery	2

Table 4-3. Battery Parts List

4.2.1 Disposable Batteries

Low Battery displays when the battery is getting low. When **Low Battery** starts to blink, the batteries are close to being drained. For maximum life, use the batteries until the system shuts off.

4.2.2 Rechargeable Batteries

When using Nickel-Metal-Hydride (NiMH) cells, it is recommended that the cells are recharged immediately after **Low Battery** starts to blink. Do not allow the batteries to discharge completely, it may compromise the recharge life of the battery.

NiMH Cells have a lower capacity than Alkaline. Having two sets of NiMH batteries is recommended, so one set can be charging while the other is in use.

IMPORTANT

The use of NiCad batteries is not recommended.

Remove the batteries prior to storing to prevent possible battery corrosion if the Dyna-Clamp is not going to be used for an extended period of time.

4.3 Drive Rod Lubrication

Make sure the drive rod threads are free of any dirt or debris. Regularly apply moly grease to the drive rod threads to maintain proper lubrication.

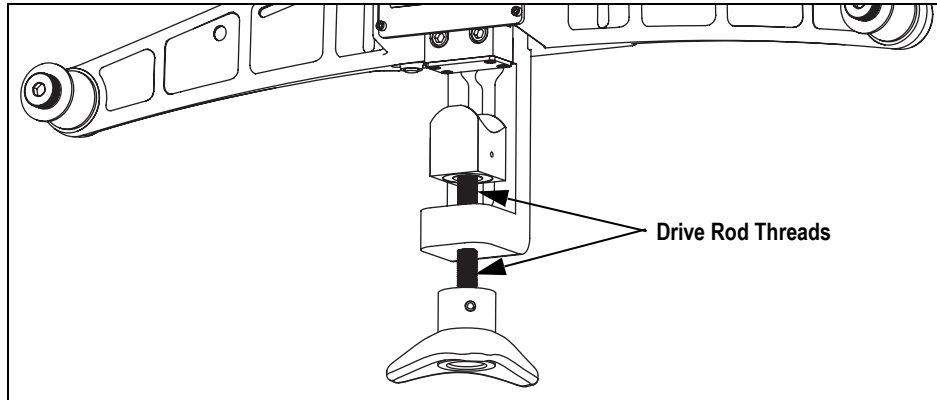

Figure 4-2. Grease Drive Rod Threads

IMPORTANT Do not use solvents or aggressive substances to clean the Dyna-Clamp. Do not clean by submersion. Make sure to lubricate the drive rod threads after cleaning.

4.4 Bobbin Replacement

1. Remove the bolt securing the wire rope bobbin to the frame and discard old bobbin.
2. Align new wire rope bobbin with hole in frame.
3. Torque bolt to 30 ft-lb (40 N-m) with blue Loctite® 242 to reinstall new wire rope bobbin. The bobbin should spin freely with very little play along the bolt axis.

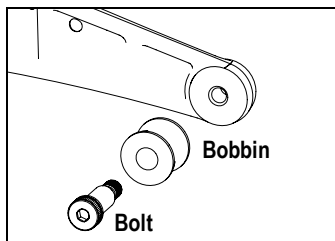

Figure 4-3. Bobbin Installation

Part No.	Description	Qty
191155	Wire Rope Bobbin	2
192660	Shoulder Bolt, 1/2-13 x 1-1/4	2

Table 4-4. Bobbin Parts List

5.0 Specifications

Power

Battery Operated Two AA Cell 1.5 V Alkaline Batteries (can be replaced with rechargeable NiMH cells)

Operating Time

Alkaline AA Cells 24 hours

Wire Rope

Diameter 3/16" (5 mm) – 1" (25 mm)

Accuracy

Rated Accuracy $\pm 3\%$ of capacity

Capacity

Maximum 12,500 lb (5,670 kg)

Units

lbf, kgf, kN

Resolution

Standard 2500 divisions

Internal A/D 24 bits

Operator Interface

Two-Line LCD Display:

Primary Display (bottom) Six, 0.7" (18 mm) numeric digits

Secondary Display (top) Eight, 0.5" (13 mm) numeric digits

Function Keys:

Programmable Keys Two (user programmable) – F1, F2 (TEST, UNIT, PRINT, SCROLL, ACTFUN)

Permanent Keys Two (fixed) – POWER, ZERO

Setpoints

Two dedicated setpoints for minimum and maximum allowable wire rope tension (LEDs for measurements outside of allowable range)

Auto-Off Mode

Prolongs battery life by turning POWER off after 15, 30, 45 or 60 minutes of no scale activity (operator determined)

Load Cell and Enclosure

Load Cell 350 Ω Bridge

Enclosure IP65 Powder Coated Aluminum Frame

Calibration

Up to eight (8) factory programmed wire rope calibrations

Environmental

Operating Temperature -40°F – 122°F (-40°C – 50°C)

Operator Use Outdoor

Storage Indoor

Warranty

Two-year limited warranty



© Rice Lake Weighing Systems Specifications subject to change without notice.
Rice Lake Weighing Systems is an ISO 9001 registered company.

230 W. Coleman St. • Rice Lake, WI 54868 • USA

U.S. 800-472-6703 • Canada/Mexico 800-321-6703 • International 715-234-9171 • Europe +31 (0)26 472 1319