

# Hardware and Accessories

## TABLE OF CONTENTS

|  |     |  |     |  |     |
|--|-----|--|-----|--|-----|
| Hardware and Accessories.....          | 421 | Leveling Pad Stems.....                                  | 435 | T-Strip Molding.....                   | 446 |
| Load Cell Mounting Hardware            |     | RoughDeck® Scale Base.....                               | 436 | Electronic Scale Tickets.....          | 447 |
| Safety Guidelines.....                 | 422 | Summit® 3000 Scale Base.....                             | 436 | Mechanical Scale Tickets.....          | 448 |
| Mounting Assembly                      |     | Floor Scale Base.....                                    | 436 | <i>Create Your Own Custom Ticket</i>   |     |
| Component Identification.....          | 423 | Complete Custom Cable Services.....                      | 437 | Printer Dust Covers.....               | 448 |
| Jam Nuts.....                          | 423 | EL147, 6 Wire.....                                       | 438 | Printer Cables.....                    | 449 |
| Eye Nuts.....                          | 424 | <i>Standard Load Cell Cable</i>                          |     | Static Brushes.....                    | 450 |
| Clevis Mount Assemblies.....           | 424 | EL147RP Plus, 6 Wire.....                                | 438 | Ionizing Strips.....                   | 450 |
| Coupling Nuts.....                     | 424 | <i>Rodent Protection Load Cell Cable</i>                 |     | Desiccants.....                        | 450 |
| Load Cell Eye Bolts.....               | 425 | EL147HE, 6 Wire.....                                     | 439 | Crimper and Lead Seals.....            | 450 |
| Rod End Ball Joints.....               | 426 | <i>Hostile Environment Load Cell Cable</i>               |     | Ionizing Strip Accessories.....        | 450 |
| Connecting Links.....                  | 426 | EL147IS, 6 Wire.....                                     | 439 | Industrial Corrosion Inhibitor.....    | 450 |
| Load Cell Isolators.....               | 427 | <i>Hazardous Environment Blue Jacket Load Cell Cable</i> |     | Static Control Wrist Strap.....        | 451 |
| Threaded Adapters.....                 | 427 | EL146, 4 Wire.....                                       | 440 | Static Shielding Bags.....             | 451 |
| ITCM Hardware Kits.....                | 428 | <i>Standard Load Cell Cable</i>                          |     | Static-safe Service Kit.....           | 451 |
| Grounding Straps.....                  | 429 | EL146HE, 4 Wire.....                                     | 440 | Rice Lake's Scale Technician Kits..... | 452 |
| Ball Bearings.....                     | 429 | <i>Hostile Environment Load Cell Cable</i>               |     |  |     |
| Load Receiver Plate.....               | 429 | Fiber-optic Cable.....                                   | 441 |  |     |
| Load Cups.....                         | 429 | EL144 Communications Cable.....                          | 441 |  |     |
| Wire Rope Assemblies.....              | 430 | BCD Cable.....   | 441 |  |     |
| Cardinal® Wire Rope Assemblies.....    | 430 | SURVIVOR® EL620HE.....                                   | 442 |  |     |
| Custom Wire Ropes.....                 | 430 | <i>High Temperature Cable</i>                            |     |  |     |
| Custom Wire Rope Definition Form.....  | 431 | EL148HE Mettler Toledo®.....                             | 442 |  |     |
| Spherical Washer Sets.....             | 432 | <i>Power Cell Replacement Cable</i>                      |     |  |     |
| Load Cell Spacers.....                 | 432 | SURVIVOR® Cable Armor.....                               | 442 |  |     |
| Load Button.....                       | 432 | Mettler Toledo® Power Cell®.....                         | 442 |  |     |
| Weldless End Links.....                | 432 | <i>Homerun Cable</i>                                     |     |  |     |
| Load Button Insert Kit.....            | 433 | Cord Grip Assemblies.....                                | 443 |  |     |
| Flintec® Adjustable Rubber Foot.....   | 433 | EL214 Cable Splicing Kit.....                            | 443 |  |     |
| Bench Scale Feet.....                  | 433 | Load Cell Conduit Adapters.....                          | 443 |  |     |
| Surefoot™.....                         | 433 | EL214T Cable Splicing Kit.....                           | 444 |  |     |
| Polyurethane Rubber Leveling Feet..... | 434 | EL215 Cable Splicing Kit.....                            | 444 |  |     |
| Captured Ball Floor Scale              |     | Flintec® Load Cell Cable.....                            | 444 |  |     |
| Leveling Feet.....                     | 434 | <i>Replacement Kits</i>                                  |     |  |     |
| Leveling Mount.....                    | 435 | Five-Position Connectors,                                |     |  |     |
| Leveling Pads.....                     | 435 | Shell Plugs, Receptacles.....                            | 445 |  |     |
|  |     | Seven-Position Connectors,                               |     |  |     |
|  |     | Shell Plugs, Receptacles.....                            | 445 |  |     |
|  |     | Six-Position Connectors,                                 |     |  |     |
|  |     | Shell Plugs, Receptacles.....                            | 445 |  |     |
|  |     | T-Grip Molding.....                                      | 446 |  |     |

The following product names, logos, brands and other trademarks featured or referred to within this publication are the property of their respective trademark holders.

# Load Cell Mounting Hardware Safety Guidelines

Install only load cell mounting hardware and assemblies that have been specifically designed for use in tank, hopper or hanging scale applications. Often, the use of an inferior-grade product results in component failure which risks equipment damage and personal injury. These simple suggestions are provided to help minimize your exposure to vessel scale installation hazards.

## 1. Estimating Gross Load

To select the correct load cell or load cell hardware for a given application, it is necessary to know the total weight on the scale—including net weight of product, tare weight of the vessel and weight of the platform, tank or hopper, as appropriate.

## 2. Safe Load

Do not exceed safe load figures listed in Rice Lake Weighing Systems' catalog for any load cell hardware. Where shock loads are present, it may be necessary to derate these safe load figures depending on severity of the shock load.

## 3. Load Distribution

In multiple-load-cell applications, weight must be evenly distributed between all cells.

## 4. Threaded Connections

Check that all threaded connections are engaged. For example, an eye bolt screwed into an s-type load cell should protrude slightly on the opposite side.

## 5. Jam Nuts

All threaded connections must be locked with jam nuts to prevent inadvertent disassembly. If a load is suspended from a single load cell, it is critical that the load cannot rotate as this may loosen the jam nut.

## 6. Wire Rope Assemblies

With wire rope assemblies, do not twist the rope during assembly or disassembly. For example, do not remove a frozen nut from one end of a rope assembly by holding the opposite end.

## 7. Attachment Points of a Load Cell

The attachment points of a load cell hardware assembly must be aligned properly and the assembly should be essentially vertical.

## 8. Swaying in a Suspended Vessel Scale

If there is excessive swaying in a suspended vessel scale, apply horizontal checking to reduce amplitude.

## 9. Safety Backup

If failure of one or more load cell hardware assemblies could cause injury or damage, a safety backup (safety chains, safety rods, etc.) must be used. The assemblies should be inspected routinely for damage, excessive wear or corrosion and replaced if necessary.

## 10. Hopper Scales: Guarding Against Contamination

With hopper scales, guard against contamination of the product being weighed in case of failure of the load cell or hardware assembly. For example, do not locate a wire rope assembly over a hopper scale where broken strands of wire could fall into the weighing vessel, contaminating the product being weighed.

## 11. Selecting Steel Rod or Any Other Weight-bearing Components

Select steel rod or any other weight-bearing components so the minimum tensile strength is at least four times the total weight carried by that component. Note that threaded rod is generally made from a low tensile-strength mild steel which should be checked for tensile strength before use in any suspended vessel scale.

# Mounting Assembly Component Identification

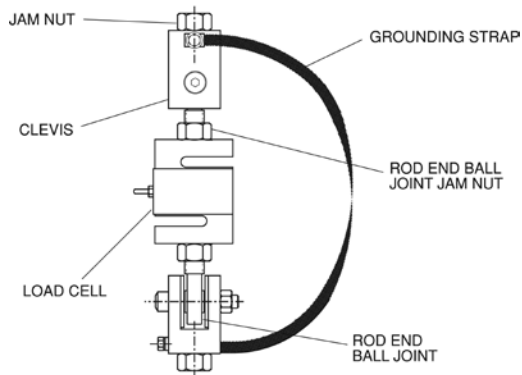

ITCM Isolated Tension Cell Mounting Assembly

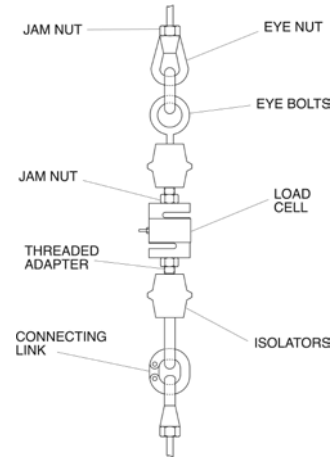

Conventional Tension Mounting Assembly

Our popular Isolated Tension Cell Mount (ITCM) assembly and other conventional suspended weighing system assemblies employ a variety of serviceable hardware components. Rice Lake Weighing Systems offers a comprehensive selection of these items for all of your suspended vessel service needs. These drawings are designed to enable you to quickly identify and differentiate components from both of these common designs. All corresponding replacement hardware is located on the following pages.

## Jam Nuts



### Standard Features

- Coarse or fine thread
- Zinc-plated mild steel or stainless steel

| Thread Size                      | Part # | Price  |
|----------------------------------|--------|--------|
| <b>Mild Steel, Fine Thread</b>   |        |        |
| 1/4-28 UNF                       | 14639  | \$1.00 |
| 3/8-24 UNF                       | 14651  | \$1.00 |
| 1/2-20 UNF                       | 14664  | \$1.60 |
| 3/4-16 UNF                       | 14687  | \$1.60 |
| 1-12 UNF                         | 14702  | \$5.99 |
| 1-14 UNF                         | 14703  | \$4.90 |
| 1 1/4-12 UNF                     | 14708  | \$3.60 |
| 1 1/2-12 UNF                     | 14711  | \$4.90 |
| <b>Mild Steel, Coarse Thread</b> |        |        |
| 1/4-20 UNC                       | 14636  | \$1.00 |
| 3/8-16 UNC                       | 14649  | \$2.25 |
| 1/2-13 UNC                       | 14661  | \$1.00 |
| 5/8-11 UNC                       | 14676  | \$4.00 |
| 3/4-10 UNC                       | 14686  | \$1.06 |
| 1-8 UNC                          | 14701  | \$1.20 |
| 1-1/4-7 UNC                      | 14707  | \$3.30 |

| Thread Size                           | Part # | Price  |
|---------------------------------------|--------|--------|
| <b>Stainless Steel, Fine Thread</b>   |        |        |
| 1/4-28 UNF                            | 14640  | \$1.30 |
| 1/2-20 UNF                            | 14665  | \$1.95 |
| 3/4-16 UNF                            | 14688  | \$2.30 |
| <b>Stainless Steel, Coarse Thread</b> |        |        |
| 3/8-16 UNC                            | 14653  | \$2.10 |
| 1/2-13 UNC                            | 14662  | \$1.85 |
| 5/8-11 UNC                            | 14680  | \$2.10 |
| 3/4-10 UNC                            | 14690  | \$2.25 |

HARDWARE AND ACCESSORIES

# Eye Nuts

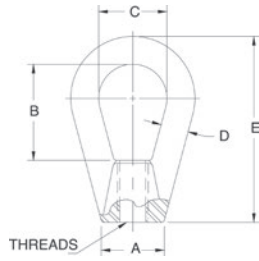

## Standard Features

- Drop-forged steel, tapped NC right-hand threads

## Part Number/Price

| Part # | A       | B       | C       | D       | E       | Thread Size | Safe Load* | Price   |
|--------|---------|---------|---------|---------|---------|-------------|------------|---------|
| 17772  | 0.50 in | 1.06 in | 0.75 in | 0.25 in | 1.68 in | 1/4-20 UNC  | 500 lb     | \$50.00 |
| 17773  | 0.75 in | 1.18 in | 0.87 in | 0.31 in | 2.25 in | 3/8-16 UNC  | 1,800 lb   | \$34.00 |
| 17774  | 1.00 in | 1.56 in | 1.12 in | 0.43 in | 3.00 in | 1/2-13 UNC  | 3,600 lb   | \$50.00 |
| 17775  | 1.25 in | 1.93 in | 1.37 in | 0.56 in | 3.75 in | 5/8-11 UNC  | 5,800 lb   | \$55.00 |

\*Do not exceed the safe load

# Coupling Nuts



## Standard Features

- Heavy hex

## Part Number/Price

| Part # | Thread Size | Length  | Flat    | Safe Load* | Price   |
|--------|-------------|---------|---------|------------|---------|
| 14638  | 1/4-20 UNC  | 1.75 in | 0.44 in | 500 lb     | \$8.50  |
| 14650  | 3/8-16 UNC  | 1.75 in | 0.62 in | 1,500 lb   | \$8.50  |
| 14663  | 1/2-13 UNC  | 1.75 in | 0.87 in | 3,000 lb   | \$8.50  |
| 14681  | 5/8-11 UNC  | 2.12 in | 1.06 in | 7,500 lb   | \$11.50 |
| 14691  | 3/4-10 UNC  | 2.25 in | 1.25 in | 10,000 lb  | \$12.50 |

\*Do not exceed the safe load

# Clevis Mount Assemblies



## Standard Features

- Mild steel or stainless steel
- Used in the ITCM assembly
- Adapts rod to rod-end ball joint
- Provides electrical isolation for load cell protection
- Eliminates unwanted side loads

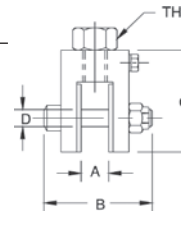

Clevis Mount with bolt

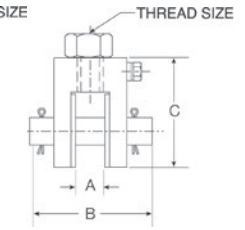

Clevis Mount with pin

## Part Number/Price

| Part #                          | A       | B       | C       | D       | Thread Size | Safe Load* | Price    |
|---------------------------------|---------|---------|---------|---------|-------------|------------|----------|
| <b>Mild Steel with Bolt</b>     |         |         |         |         |             |            |          |
| 17792                           | 0.52 in | 2.38 in | 1.94 in | 0.38 in | 3/8-16 UNC  | 300 lb     | \$87.00  |
| 17793                           | 0.52 in | 2.38 in | 1.94 in | 0.38 in | 1/2-13 UNC  | 300 lb     | \$87.00  |
| 17783                           | 0.39 in | 1.81 in | 1.69 in | 0.25 in | 1/2-13 UNC  | 500 lb     | \$99.00  |
| 17784                           | 0.65 in | 2.68 in | 2.31 in | 0.50 in | 3/4-10 UNC  | 4,000 lb   | \$99.00  |
| 17785                           | 0.78 in | 3.37 in | 3.00 in | 0.62 in | 1-8 UNC     | 10,000 lb  | \$99.00  |
| 17786                           | 0.39 in | 1.81 in | 1.69 in | 0.25 in | 3/8-16 UNC  | 500 lb     | \$94.00  |
| 17787                           | 0.65 in | 2.68 in | 2.31 in | 0.50 in | 1/2-13 UNC  | 2,000 lb   | \$99.00  |
| 17788                           | 0.65 in | 2.68 in | 2.31 in | 0.50 in | 5/8-11 UNC  | 2,500 lb   | \$99.00  |
| 17789                           | 0.78 in | 3.37 in | 3.00 in | 0.62 in | 3/4-10 UNC  | 5,000 lb   | \$99.00  |
| <b>Mild Steel with Pin</b>      |         |         |         |         |             |            |          |
| 17790                           | 1.39 in | 4.12 in | 4.50 in | 1.00 in | 1 1/4-7 UNC | 15,000 lb  | \$367.00 |
| 17791                           | 1.22 in | 4.12 in | 5.00 in | 1.25 in | 1 1/2-6 UNC | 20,000 lb  | \$367.00 |
| <b>Stainless Steel with Pin</b> |         |         |         |         |             |            |          |
| 33644                           | 0.52 in | 2.38 in | 1.94 in | 0.38 in | 1/2-13 UNC  | 300 lb     | \$192.00 |
| 33643                           | 0.39 in | 1.81 in | 1.69 in | 0.25 in | 1/2-13 UNC  | 500 lb     | \$192.00 |
| 33641                           | 0.39 in | 1.81 in | 1.69 in | 0.25 in | 3/8-16 UNC  | 500 lb     | \$192.00 |
| 33658                           | 0.52 in | 2.38 in | 1.94 in | 0.38 in | 3/8-16 UNC  | 500 lb     | \$192.00 |
| 33642                           | 0.65 in | 2.68 in | 2.31 in | 0.50 in | 3/4-10 UNC  | 4,000 lb   | \$250.00 |
| 33640                           | 0.65 in | 2.68 in | 2.31 in | 0.50 in | 1/2-13 UNC  | 2,000 lb   | \$250.00 |
| 33639                           | 0.65 in | 2.68 in | 2.31 in | 0.50 in | 5/8-11 UNC  | 2,500 lb   | \$250.00 |
| 33638                           | 0.78 in | 3.37 in | 3.00 in | 0.62 in | 3/4-10 UNC  | 5,000 lb   | \$250.00 |

\*Do not exceed the safe load

# Load Cell Eye Bolts

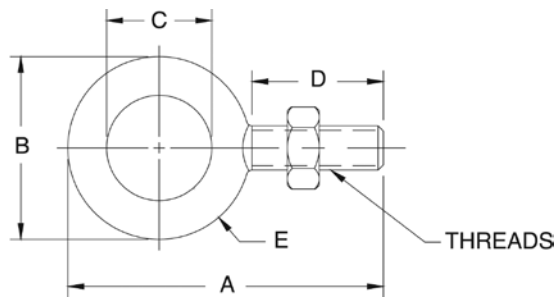

## Standard Features

- Mild steel
- One jam nut included with each eye bolt

## Part Number/Price

| Part #            | A       | B       | C       | D       | E       | Thread Size | Safe Load* | Price    |
|-------------------|---------|---------|---------|---------|---------|-------------|------------|----------|
| <b>Mild Steel</b> |         |         |         |         |         |             |            |          |
| 17705             | 2.25 in | 1.25 in | 0.75 in | 1.00 in | 0.25 in | 1/4-28 UNF  | 500 lb     | \$30.00  |
| 17707             | 2.91 in | 1.66 in | 1.00 in | 1.25 in | 0.33 in | 3/8-24 UNF  | 1,300 lb   | \$30.00  |
| 17709             | 3.56 in | 2.06 in | 1.19 in | 1.50 in | 0.44 in | 1/2-20 UNF  | 2,400 lb   | \$31.00  |
| 17711             | 4.25 in | 2.50 in | 1.37 in | 1.75 in | 0.56 in | 5/8-18 UNF  | 4,000 lb   | \$36.00  |
| 17713             | 4.81 in | 2.81 in | 1.50 in | 2.00 in | 0.66 in | 3/4-16 UNF  | 5,000 lb   | \$76.00  |
| 17715             | 6.06 in | 3.56 in | 1.81 in | 2.50 in | 0.87 in | 1-12 UNF    | 9,000 lb   | \$120.00 |
| 17716             | 6.06 in | 3.56 in | 1.81 in | 2.50 in | 0.87 in | 1-14 UNS    | 9,000 lb   | \$120.00 |
| 17704             | 2.25 in | 1.25 in | 0.75 in | 1.00 in | 0.25 in | 1/4-20 UNC  | 500 lb     | \$25.00  |
| 17706             | 2.91 in | 1.66 in | 1.00 in | 1.25 in | 0.33 in | 3/8-16 UNC  | 1,300 lb   | \$27.00  |
| 17708             | 3.56 in | 2.06 in | 1.19 in | 1.50 in | 0.44 in | 1/2-13 UNC  | 2,400 lb   | \$27.00  |
| 17710             | 4.25 in | 2.50 in | 1.37 in | 1.75 in | 0.56 in | 5/8-11 UNC  | 4,000 lb   | \$40.00  |
| 17712             | 4.81 in | 2.81 in | 1.50 in | 2.00 in | 0.66 in | 3/4-10 UNC  | 5,000 lb   | \$60.00  |
| 17714             | 6.06 in | 3.56 in | 1.81 in | 2.50 in | 0.87 in | 1-8 UNC     | 9,000 lb   | \$62.00  |
| 17717             | 7.44 in | 4.44 in | 2.19 in | 3.00 in | 1.12 in | 1 1/4-7 UNC | 15,000 lb  | \$175.00 |

\*Do not exceed the safe load

HARDWARE AND ACCESSORIES

# Rod End Ball Joints

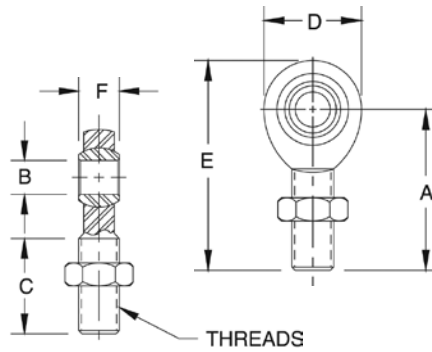

## Standard Features

- Mild steel or stainless steel
- Used in the ITCM assembly
- One jam nut included with each rod end ball joint

## Part Number/Price

| Part #                 | Safe Load* | Breaking Strength | PTFE Lined | Price    |
|------------------------|------------|-------------------|------------|----------|
| <b>Mild Steel</b>      |            |                   |            |          |
| 17746                  | 975 lb     | 3,915 lb          | YES        | \$34.00  |
| 17734                  | 1,200 lb   | 4,916 lb          | NO         | \$24.00  |
| 17736                  | 4,000 lb   | 16,238 lb         | NO         | \$60.00  |
| 17738                  | 7,000 lb   | 28,081 lb         | NO         | \$103.00 |
| 17735                  | 2,000 lb   | 8,075 lb          | NO         | \$29.00  |
| 17737                  | 3,250 lb   | 13,831 lb         | NO         | \$42.00  |
| 17739                  | 500 lb     | 2,158 lb          | YES        | \$34.00  |
| 17740                  | 4,000 lb   | 16,238 lb         | YES        | \$55.00  |
| 17741                  | 10,000 lb  | 40,572 lb         | YES        | \$82.00  |
| 17742                  | 10,500 lb  | 43,541 lb         | NO         | \$154.00 |
| 26007                  | 15,000 lb  | 76,200 lb         | YES        | \$318.00 |
| 17747                  | 19,000 lb  | 76,200 lb         | YES        | \$366.00 |
| 17743                  | 20,000 lb  | 79,728 lb         | NO         | \$276.00 |
| 17744                  | 24,000 lb  | 96,510 lb         | NO         | \$382.00 |
| <b>Stainless Steel</b> |            |                   |            |          |
| 33505                  | 500 lb     | 2,158 lb          | YES        | \$148.00 |
| 33506                  | 1,500 lb   | 7,362 lb          | YES        | \$148.00 |
| 33507                  | 3,000 lb   | 16,238 lb         | YES        | \$159.00 |
| 33508                  | 7,000 lb   | 40,572 lb         | YES        | \$366.00 |

\*Do not exceed the safe load

## Dimensions

| Part #                 | A       | B       | C       | D       | E       | F       | Thread Size  |
|------------------------|---------|---------|---------|---------|---------|---------|--------------|
| <b>Mild Steel</b>      |         |         |         |         |         |         |              |
| 17746                  | 1.94 in | 0.37 in | 1.25 in | 1.00 in | 2.43 in | 0.50 in | 3/8-24 UNF   |
| 17734                  | 1.94 in | 0.37 in | 1.25 in | 1.00 in | 2.43 in | 0.50 in | 3/8-24 UNF   |
| 17736                  | 2.44 in | 0.50 in | 1.50 in | 1.31 in | 3.09 in | 0.62 in | 1/2-20 UNF   |
| 17738                  | 2.87 in | 0.75 in | 1.75 in | 1.75 in | 3.75 in | 0.87 in | 3/4-16 UNF   |
| 17735                  | 2.44 in | 0.50 in | 1.50 in | 1.31 in | 3.09 in | 0.62 in | 1/2-20 UNF   |
| 17737                  | 2.87 in | 0.75 in | 1.75 in | 1.75 in | 3.75 in | 0.87 in | 3/4-16 UNF   |
| 17739                  | 1.56 in | 0.25 in | 1.00 in | 0.75 in | 1.93 in | 0.37 in | 1/4-28 UNF   |
| 17740                  | 2.44 in | 0.50 in | 1.50 in | 1.31 in | 3.09 in | 0.62 in | 1/2-20 UNF   |
| 17741                  | 2.87 in | 0.62 in | 1.75 in | 1.75 in | 3.75 in | 0.75 in | 3/4-16 UNF   |
| 17742                  | 4.12 in | 1.00 in | 2.12 in | 2.75 in | 5.50 in | 1.37 in | 1-12 UNF     |
| 26007                  | 4.12 in | 1.00 in | 2.12 in | 2.75 in | 5.50 in | 1.37 in | 1-14 UNS     |
| 17747                  | 4.12 in | 1.00 in | 2.12 in | 2.75 in | 5.50 in | 1.37 in | 1-12 UNF     |
| 17743                  | 4.12 in | 1.25 in | 2.12 in | 2.75 in | 5.50 in | 1.09 in | 1 1/4-12 UNF |
| 17744                  | 5.37 in | 1.50 in | 3.00 in | 3.50 in | 7.12 in | 1.31 in | 1 1/2-12 UNF |
| <b>Stainless Steel</b> |         |         |         |         |         |         |              |
| 33506                  | 1.94 in | 0.37 in | 1.25 in | 1.00 in | 2.43 in | 0.50 in | 3/8-24 UNF   |
| 33505                  | 1.56 in | 0.25 in | 1.00 in | 0.75 in | 1.93 in | 0.37 in | 1/4-28 UNF   |
| 33507                  | 2.44 in | 0.50 in | 1.50 in | 1.31 in | 3.09 in | 0.62 in | 1/2-20 UNF   |
| 33508                  | 2.87 in | 0.62 in | 1.75 in | 1.75 in | 3.75 in | 0.75 in | 3/4-16 UNF   |

HARDWARE AND ACCESSORIES

# Connecting Links

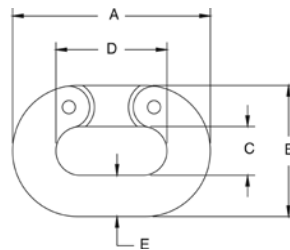

## Standard Features

- Drop-forged carbon steel, heat-treated, hot-dipped galvanized finish

## Part Number/Price

| Part # | A       | B       | C       | D       | E       | Safe Load* | Price    |
|--------|---------|---------|---------|---------|---------|------------|----------|
| 17794  | 1.50 in | 1.00 in | 0.43 in | 0.87 in | 0.25 in | 1,325 lb   | \$45.00  |
| 17795  | 2.06 in | 1.37 in | 0.56 in | 1.12 in | 0.37 in | 2,750 lb   | \$48.00  |
| 17797  | 3.31 in | 2.09 in | 0.78 in | 1.81 in | 0.62 in | 7,250 lb   | \$58.00  |
| 17798  | 3.87 in | 2.50 in | 0.93 in | 2.12 in | 0.75 in | 10,250 lb  | \$77.00  |
| 17799  | 5.00 in | 3.31 in | 1.25 in | 2.75 in | 1.00 in | 15,500 lb  | \$130.00 |

\*Do not exceed the safe load

# Load Cell Isolators



Power surges such as those caused by welding or electrical shorts frequently damage load cells and indicators. To prevent such damage, these isolators electrically separate the mechanical assembly from its tension-type load cell.

## Part Number/Price

| Part # | Height Thread Size      | Diameter | Safe Load* | Price    |
|--------|-------------------------|----------|------------|----------|
| 17722  | 3/8-16 UNC              | 2.50 in  | 600 lb     | \$52.00  |
| 17724  | 1/2-13 UNC              | 2.50 in  | 600 lb     | \$56.00  |
| 17726  | 1/2-20 UNF              | 2.50 in  | 600 lb     | \$95.00  |
| 17725  | 1/2-13 UNC              | 2.00 in  | 3,000 lb   | \$130.00 |
| 17723  | 3/8-24 UNF              | 2.50 in  | 600 lb     | \$98.00  |
| 17728  | 1/2-13 UNC × 1/2-20 UNF | 2.50 in  | 600 lb     | \$73.00  |
| 17732  | 1/4-20 UNC              | 1.12 in  | 250 lb     | \$56.00  |

\*Do not exceed the safe load

# Threaded Adapters

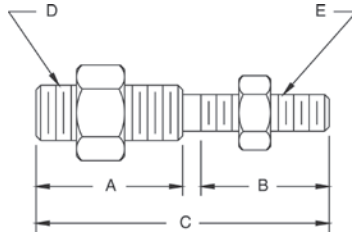

## Standard Features

- For coupling isolators with load cells and steelyard rods
- Supplied with jam nuts
- Stainless steel

## Part Number/Price

| Part # | A       | B       | C       | D          | E          | Safe Load* | Price   |
|--------|---------|---------|---------|------------|------------|------------|---------|
| 33561  | -       | -       | 2.00 in | 1/4-28 UNF | 1/4-28 UNF | 300 lb     | \$29.00 |
| 33562  | 0.94 in | 0.94 in | 2.00 in | 1/4-28 UNF | 1/4-20 UNC | 300 lb     | \$32.00 |
| 33563  | 0.92 in | 1.02 in | 2.06 in | 1/4-28 UNF | 3/8-24 UNF | 300 lb     | \$37.00 |
| 33564  | 0.94 in | 0.94 in | 2.00 in | 1/4-28 UNF | 3/8-16 UNC | 300 lb     | \$29.00 |
| 33565  | 1.06 in | 1.06 in | 2.25 in | 1/4-20 UNC | 3/8-16 UNC | 300 lb     | \$32.00 |
| 33567  | 1.06 in | 1.06 in | 2.25 in | 1/4-28 UNF | 1/2-13 UNC | 300 lb     | \$32.00 |
| 33568  | -       | -       | 2.00 in | 3/8-24 UNF | 3/8-24 UNF | 500 lb     | \$42.00 |
| 33569  | 0.91 in | 0.91 in | 2.00 in | 3/8-16 UNC | 3/8-24 UNF | 500 lb     | \$36.00 |
| 33570  | 1.06 in | 1.06 in | 2.25 in | 3/8-24 UNF | 1/2-13 UNC | 500 lb     | \$32.00 |
| 33571  | 1.31 in | 1.31 in | 2.75 in | 1/2-13 UNC | 5/8-11 UNC | 3,000 lb   | \$32.00 |
| 33572  | 0.87 in | 0.87 in | 2.00 in | 1/2-13 UNC | 1/2-20 UNF | 3,000 lb   | \$36.00 |
| 33573  | -       | -       | 2.06 in | 1/2-20 UNF | 1/2-20 UNF | 3,000 lb   | \$36.00 |
| 33574  | 1.31 in | 1.31 in | 2.75 in | 1/2-20 UNF | 5/8-11 UNC | 3,000 lb   | \$38.00 |
| 33575  | 1.31 in | 1.31 in | 3.00 in | 3/4-16 UNF | 3/4-10 UNC | 7,000 lb   | \$40.00 |

\*Do not exceed the safe load

# ITCM Hardware Kits



Mount only - does not include load cell

The Isolated Tension Cell Mount (ITCM) is a mounting assembly designed for tension mounting S-beam load cells in suspended hopper assemblies and mechanical scale conversions. The ITCM incorporates clevis and unique rod end ball joint assemblies, reducing the overall length to less than half of traditional tension cell mounts, while providing correct load alignment. In addition, the load cell is completely electrically isolated from stray currents, a major cause of load cell failure. To complete the design, a grounding strap connects the two clevis assemblies to further ensure load cell safety.

## Standard Features

- Provides greater safety than traditional suspension configurations
- Complete package for ease of installation
- Built-in electrical isolation without having to use isolators (not available on 20,000 lb version)
- Provides correct load cell loading even in difficult installations
- Dramatically reduces overall length
- Capacities from 300 to 20,000 lb
- Clevis mounts with nylon insulating washers
- PTFE-lined rod end ball joints (not available on 20,000 lb version)
- Completely isolates load cell from stray currents
- Grounding strap for electrical continuity
- Zinc plated clevis
- Mount only: does not include load cell

## Applications

- Suspended hoppers
- Mechanical scale conversions
- Replaces traditional eye bolt, isolator configurations

## Part Number/Price

| Part #                 | Load Rating          | Clevis Thread | Rod End Thread | Safe Load* | Price      |
|------------------------|----------------------|---------------|----------------|------------|------------|
| <b>Mild Steel</b>      |                      |               |                |            |            |
| 17968                  | 300 lb               | 3/8-16        | 3/8-24         | 300 lb     | \$236.00   |
| 17969                  | 300 lb               | 1/2-13        | 3/8-24         | 300 lb     | \$236.00   |
| 17894                  | 500 lb               | 3/8-16        | 1/4-28         | 500 lb     | \$236.00   |
| 17895                  | 500 lb               | 1/2-13        | 1/4-28         | 500 lb     | \$236.00   |
| 17896                  | 2,000 lb             | 1/2-13        | 1/2-20         | 2,000 lb   | \$285.00   |
| 17897                  | 2,500 lb             | 5/8-11        | 1/2-20         | 2,500 lb   | \$285.00   |
| 17898                  | 4,000 lb             | 3/4-10        | 1/2-20         | 4,000 lb   | \$285.00   |
| 17899                  | 5,000 lb             | 3/4-10        | 3/4-16         | 5,000 lb   | \$325.00   |
| 17900                  | 10,000 lb            | 1-8           | 3/4-16         | 10,000 lb  | \$325.00   |
| 17958                  | 15,000 lb (RL20000I) | 1 1/4-7       | 1-12           | 15,000 lb  | \$1,284.00 |
| 63166                  | 15,000 lb (RL20001)  | 1 1/4-7       | 1-14           | 15,000 lb  | \$1,229.00 |
| 17959                  | 20,000 lb**          | 1 1/2-6       | 1 1/4-12       | 20,000 lb  | \$1,134.00 |
| <b>Stainless Steel</b> |                      |               |                |            |            |
| 33630                  | 500 lb               | 3/8-16        | 3/8-24         | 500 lb     | \$643.00   |
| 33631                  | 300 lb               | 1/2-13        | 3/8-24         | 300 lb     | \$643.00   |
| 33632                  | 500 lb               | 3/8-16        | 1/4-28         | 500 lb     | \$643.00   |
| 33633                  | 500 lb               | 1/2-13        | 1/4-28         | 500 lb     | \$643.00   |
| 33634                  | 2,000 lb             | 1/2-13        | 1/2-20         | 2,000 lb   | \$774.00   |
| 33635                  | 2,500 lb             | 5/8-11        | 1/2-20         | 2,500 lb   | \$774.00   |
| 33636                  | 3,000 lb             | 3/4-10        | 1/2-20         | 3,000 lb   | \$774.00   |
| 33637                  | 5,000 lb             | 3/4-10        | 3/4-16         | 5,000 lb   | \$1,124.00 |

\* Do not exceed the safe load \*\*Not electrically isolated

Note: Replacement parts for mounts can be found in the Replacement Parts Catalog.

# Grounding Straps



## Standard Features

- Used in the ITCM assembly
- Tinned copper braid
- Crimped sleeve on ends with 0.25 in hole
- Available in 12 in, 14 in, 16 in, 24 in or 32 in lengths

## Part Number/Price

| Part # | Length | Price   |
|--------|--------|---------|
| 17778  | 12 in  | \$22.00 |
| 17779  | 14 in  | \$22.00 |
| 17780  | 16 in  | \$22.00 |
| 17781  | 24 in  | \$22.00 |
| 17782  | 32 in  | \$30.00 |

# Ball Bearings



## Standard Features

- Use with load cup and load receiver to build a custom scale
- 52100 chrome alloy steel

## Part Number/Price

| Part # | Drawing Dimensions                         | Price   |
|--------|--|---------|
| 18815  | 5/8 in diameter crush strength 32,000 lb   | \$16.00 |
| 18816  | 7/8 in diameter crush strength 59,000 lb   | \$18.00 |
| 65841  | 1.25 in diameter crush strength 100,000 lb | \$37.00 |

# Load Receiver Plate

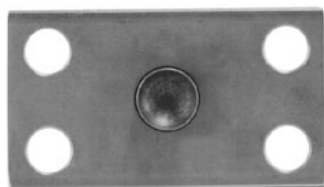

## Standard Features

- Design offers accurate point loading
- Self-centering effect built in
- Use with load cup and ball bearings to build a custom scale
- Ball and cup load introduction provides point loading for maximum accuracy
- Stainless steel construction

## Part Number/Price

| Part # | Description         | Price   |
|--------|---------------------|---------|
| 18832  | Load receiver plate | \$58.00 |

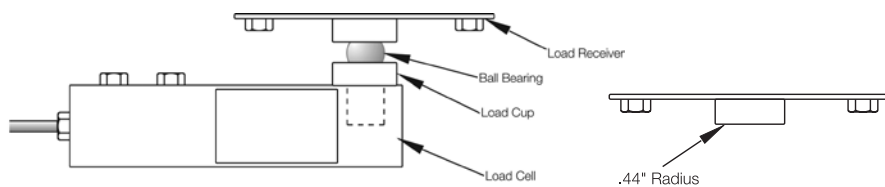
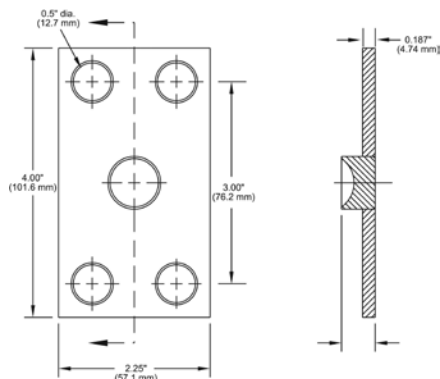

HARDWARE AND ACCESSORIES

# Load Cups

## Standard Features

- Ball and cup load introduction provides point loading for maximum accuracy
- For use with most popular single-ended beam load cells
- Constructed of 440C stainless steel

## Part Number/Price

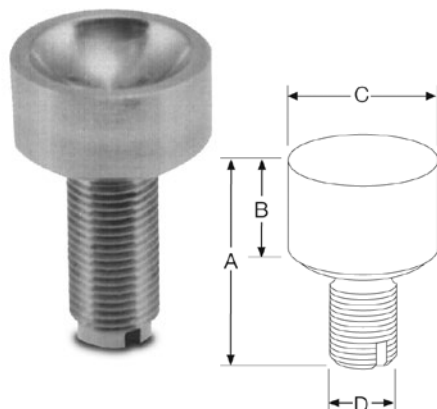

| Part # | A  | B       | C       | D          | Price    |
|--------|--|---------|---------|------------|----------|
| 31911  | 1.70 in  | 0.54 in | 1.07 in | 1/2-20 UNF | \$58.00  |
| 212364 | 1.70 in  | 0.54 in | 1.07 in | M8         | \$70.00  |
| 33654  | 1.12 in  | 0.54 in | 0.78 in | 1/2-20 UNF | \$49.00  |
| 33653  | 1.50 in  | 0.80 in | 1.12 in | 3/4-16 UNF | \$50.00  |
| 33652  | 2.00 in  | 0.85 in | 1.75 in | 1-12 UNF   | \$118.00 |
| 33651  | 2.85 in  | 0.85 in | 1.75 in | 1-12 UNF   | \$165.00 |
| 33650  | 2.85 in  | 0.85 in | 1.75 in | 1-14 UNF   | \$165.00 |
| 33647  | 2.75 in  | 0.50 in | 0.75 in | 1/2-20 UNF | \$59.00  |
| 72364  | 1.78 in  | 0.53 in | 0.78 in | 1/2-20 UNF | \$69.00  |
| 69431  | Replacement cup for Cardinal® SCA-50,000 load cell |         |         |            | \$143.00 |

# Wire Rope Assemblies

*Note: Wire ropes should not be exposed to shock loads, chemicals or twisting. Chains or rods should be used as a safety backup in case of catastrophic failure.*

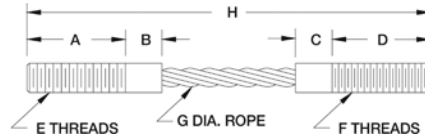

## Wire Rope Assemblies

- Wire rope assemblies provide better alignment and greatly increase load cell repeatability. In addition, they act as natural vibration dampeners.

### Part Number/Price

| Part #    | A       | B & C   | D       | E             | F             | G        | H       | Safe Load* | Price    |
|-----------|---------|---------|---------|---------------|---------------|----------|---------|------------|----------|
| 17760     | 0.87 in | 0.50 in | 0.87 in | 1/4-20 UNC-2A | 1/4-28 UNF-2A | 0.12 in  | 4.00 in | 400 lb     | \$58.00  |
| 17762     | 1.25 in | 0.50 in | 1.25 in | 3/8-16 UNC-2A | 3/8-24 UNF-2A | 0.18 in  | 5.00 in | 850 lb     | \$64.00  |
| 17766     | 1.62 in | 0.50 in | 1.62 in | 1/2-13 UNC-2A | 1/2-20 UNF-2A | 0.25 in  | 6.50 in | 1,400 lb   | \$66.00  |
| 17765     | 1.62 in | 0.50 in | 1.62 in | 1/2-13 UNC-2A | 1/2-20 UNF-2A | 0.25 in  | 5.50 in | 1,400 lb   | \$79.00  |
| 17764     | 1.00 in | -       | 1.37 in | 1/2-20 UNF-2A | 1/2-20 UNF-2A | 0.25 in  | 4.00 in | 1,400 lb   | \$95.00  |
| 17768     | 2.00 in | -       | 2.50 in | 3/8-24 UNF-2A | 3/8-24 UNF-2A | 0.12 in  | 5.50 in | 400 lb     | \$143.00 |
| 17769**   | 1.25 in | -       | 0.75 in | 1/4-28 UNF-2A | 1/4-28 UNF-2A | 0.12 in  | 3.00 in | 400 lb     | \$159.00 |
| 17771**   | 1.25 in | -       | 0.75 in | 1/2-20 UNF-2A | 1/2-20 UNF-2A | 0.25 in  | 3.00 in | 1,400 lb   | \$69.00  |
| 115292*** | 1.25 in | -       | 0.75 in | 1/4-28 UNF-2A | 1/4-28 UNF-2A | 0.12 in  | 3.00 in | 300 lb     | \$111.00 |
| 33084**** | 1.31 in | -       | 1.00 in | 1/2-20 UNF    | 1/2-20 UNF    | 0.125 in | 3.62 in | 850 lb     | \$87.00  |

\*Do not exceed the safe load \*\*Used with Rice Lake Weighing Systems flexure bases \*\*\*Stainless steel \*\*\*\*Used with Rice Lake Weighing Systems FXB flexure bases

# Cardinal® Wire Rope Assemblies

HARDWARE AND ACCESSORIES

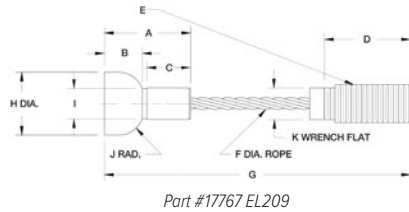

Part #17767 EL209

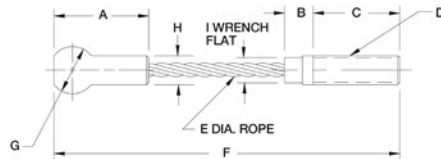

Part #17763 EL208

## Cardinal Wire Rope Assemblies

- EL208 Cardinal wire rope assembly: Used on 7,500 lb capacity FH model and 8,000 lb capacity EP model
- EL209 Cardinal wire rope assembly: Used on 20,000 lb capacity FH and EP models. May also be used on 15,000 lb capacity FH and EP models

### Part Number/Price

| Part # | A       | B       | C       | D       | E       | F          | G             | H       | I       | J       | K       | L & M    | N        | Safe Load* | Price    |
|--------|---------|---------|---------|---------|---------|------------|---------------|---------|---------|---------|---------|----------|----------|------------|----------|
| 17763  | 1.50 in | -       | 0.50 in | 1.50 in | -       | 1/2-13 UNC | 0.25 in       | 6.00 in | 0.81 in | 0.43 in | -       | -        | 0.43 in  | 1,400 lb   | \$126.50 |
| 17767  | 1.71 in | 0.75 in | 0.09 in | 2.00 in | 0.43 in | 6.31 in    | 3/4-10 UNC-2A | 1.25 in | -       | 0.60 in | 0.50 in | 0.625 in | 0.375 in | 2,880 lb   | \$247.50 |

\*Do not exceed the safe load

# Custom Wire Ropes

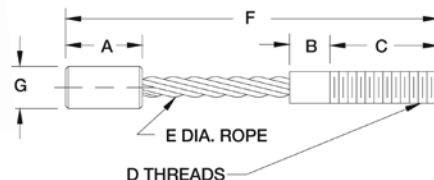

## Custom Wire Ropes

- When ordering, please complete Custom Wire Rope Definition form and provide a sample if possible, and specify the required tension rating and total capacity
- Wire ropes should not be exposed to shock loads, chemicals or twisting. Chains or rods should be used as safety backup in case of catastrophic failure.

# Custom Wire Rope Definition

Customer Number:

Company:  Name:

Date:  Phone:  Fax:  Email:

## Background Information

Application  Safe Load

Environment  Desired Material

## Custom Wire Rope Dimensions

Check the desired style and enter dimensions. Use drawings for reference.

**Style 1**

|  |   |
|--|---|
| <b>A</b> THREAD LENGTH <input type="text"/>  | <b>B</b> LENGTH <input type="text"/>        |
| <b>C</b> SHANK LENGTH <input type="text"/>   | <b>D</b> THREAD LENGTH <input type="text"/> |
| <b>E</b> THREADS <input type="text"/>        | <b>F</b> ROPE DIAMETER <input type="text"/> |
| <b>G</b> OVERALL LENGTH <input type="text"/> | <b>H</b> BALL DIAMETER <input type="text"/> |
| <b>I</b> SHANK DIAMETER <input type="text"/> | <b>J</b> RADIUS <input type="text"/>        |
| <b>K</b> WRENCH FLAT <input type="text"/>    |   |

**Style 2**

|   |  |
|---|--|
| <b>A</b> THREAD LENGTH <input type="text"/> | <b>B</b> SHANK LENGTH <input type="text"/>   |
| <b>C</b> THREAD LENGTH <input type="text"/> | <b>D</b> THREADS <input type="text"/>        |
| <b>E</b> ROPE DIAMETER <input type="text"/> | <b>F</b> OVERALL LENGTH <input type="text"/> |
| <b>G</b> BALL DIAMETER <input type="text"/> | <b>H</b> SHANK DIAMETER <input type="text"/> |
| <b>I</b> WRENCH FLAT <input type="text"/>   |  |

**Style 3**

|  |  |
|--|--|
| <b>A</b> THREAD LENGTH <input type="text"/>  | <b>B</b> SHANK LENGTH <input type="text"/>   |
| <b>C</b> THREAD LENGTH <input type="text"/>  | <b>D</b> THREADS <input type="text"/>        |
| <b>E</b> ROPE DIAMETER <input type="text"/>  | <b>F</b> OVERALL LENGTH <input type="text"/> |
| <b>G</b> SHANK DIAMETER <input type="text"/> |  |

**Style 4/5**

|   |  |
|---|--|
| <b>A</b> THREAD LENGTH <input type="text"/> | <b>B</b> SHANK LENGTH <input type="text"/>   |
| <b>C</b> SHANK LENGTH <input type="text"/>  | <b>D</b> THREAD LENGTH <input type="text"/>  |
| <b>E</b> THREADS <input type="text"/>       | <b>F</b> THREADS <input type="text"/>        |
| <b>G</b> ROPE DIAMETER <input type="text"/> | <b>H</b> OVERALL LENGTH <input type="text"/> |

# Spherical Washer Sets

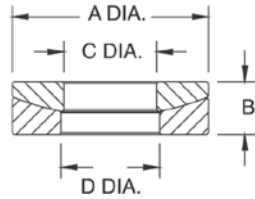

## Part Number/Price

| Part #                 | Bolt Size | A       | B       | C       | D       | Price    |
|------------------------|-----------|---------|---------|---------|---------|----------|
| <b>Mild Steel</b>      |           |         |         |         |         |          |
| 15196                  | 0.25 in   | 0.62 in | 0.20 in | 0.28 in | 0.31 in | \$16.00  |
| 15197                  | 0.38 in   | 0.88 in | 0.25 in | 0.41 in | 0.44 in | \$19.00  |
| 15198                  | 0.50 in   | 1.12 in | 0.31 in | 0.53 in | 0.56 in | \$8.50   |
| 15199                  | 0.62 in   | 1.38 in | 0.31 in | 0.66 in | 0.69 in | \$20.00  |
| 15200                  | 0.75 in   | 1.62 in | 0.38 in | 0.78 in | 0.81 in | \$25.00  |
| 15201                  | 1.00 in   | 2.00 in | 0.50 in | 1.06 in | 1.12 in | \$39.00  |
| 15202                  | 1.25 in   | 2.62 in | 0.50 in | 1.31 in | 1.38 in | \$72.00  |
| 15203                  | 1.50 in   | 2.88 in | 0.53 in | 1.56 in | 1.62 in | \$79.00  |
| 15205                  | 2.00 in   | 3.88 in | 0.81 in | 2.06 in | 2.12 in | \$127.00 |
| <b>Stainless Steel</b> |           |         |         |         |         |          |
| 33218                  | 0.50 in   | 1.12 in | 0.31 in | 0.53 in | 0.56 in | \$27.00  |
| 33220                  | 0.75 in   | 1.62 in | 0.38 in | 0.78 in | 0.81 in | \$38.00  |

# Weldless End Links

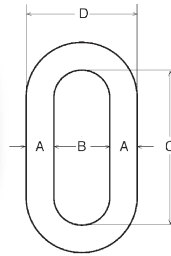

## Standard Features

- Self-colored or hot-dip galvanized finish
- Forged carbon steel quenched and tempered

## Part Number/Price

| Part # | A        | B       | C       | D       | Safe Load* | Price    |
|--------|----------|---------|---------|---------|------------|----------|
| F312L  | 0.625 in | 1.00 in | 3.25 in | 2.32 in | 9,300 lb   | \$60.00  |
| 17810  | 0.875 in | 2.00 in | 5.13 in | 3.75 in | 12,000 lb  | \$175.00 |
| 21911  | 1.00 in  | 2.25 in | 5.75 in | 4.25 in | 15,200 lb  | \$344.00 |
| 65430  | 1.25 in  | 2.50 in | 7.00 in | 5.00 in | 26,400 lb  | \$159.00 |
| 21912  | 1.375 in | 2.75 in | 7.75 in | 5.50 in | 30,000 lb  | \$488.00 |

\*Do not exceed the safe load

# Load Cell Spacers

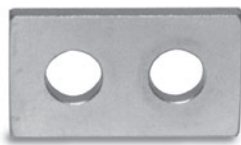

## Standard Features

- Use with most popular single-ended beams
- Provides flat mounting surface required for optimal load cell performance
- Zinc-plated mild steel or stainless steel

## Part Number/Price

| Part #                 | C       | H       | H1      | L       | L1      | L2      | W       | Price   |
|------------------------|---------|---------|---------|---------|---------|---------|---------|---------|
| <b>Mild Steel</b>      |         |         |         |         |         |         |         |         |
| 17754                  | 0.53 in | 1.25 in | 0.62 in | 2.25 in | 0.62 in | 1.00 in | 0.25 in | \$29.00 |
| 17755                  | 0.78 in | 1.50 in | 0.75 in | 3.00 in | 0.75 in | 1.50 in | 0.25 in | \$29.00 |
| 17756                  | 1.03 in | 2.00 in | 1.00 in | 4.00 in | 1.00 in | 2.00 in | 0.25 in | \$30.00 |
| 18260                  | 0.53 in | 1.25 in | 0.62 in | 2.25 in | 0.62 in | 1.00 in | 0.37 in | \$31.00 |
| <b>Stainless Steel</b> |         |         |         |         |         |         |         |         |
| 17757                  | 0.78 in | 1.50 in | 0.75 in | 3.00 in | 0.75 in | 1.50 in | 0.25 in | \$37.00 |
| 18383                  | 0.53 in | 1.25 in | 0.62 in | 2.25 in | 0.62 in | 1.00 in | 0.37 in | \$32.00 |
| 18411                  | 0.53 in | 1.25 in | 0.62 in | 2.25 in | 0.62 in | 1.00 in | 0.25 in | \$33.00 |

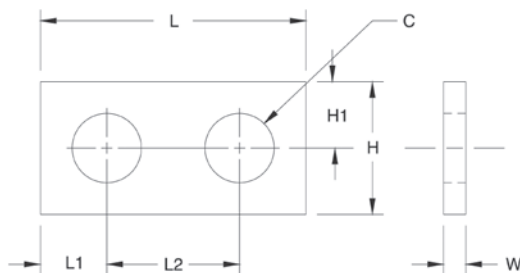

# Load Button



## Standard Features

### Load Button

- Suitable for use with compression mounting assemblies, canisters, S-beams and single-ended beams
- Hardened alloy steel

## Part Number/Price

| Part # | T          | D       | H       | H1      | R       | W       | Price   |
|--------|------------|---------|---------|---------|---------|---------|---------|
| 17750  | 3/8-24 UNF | 0.75 in | 0.60 in | 0.30 in | 2.00 in | 0.63 in | \$37.00 |
| 17751  | 1/2-20 UNF | 0.75 in | 0.70 in | 0.30 in | 4.00 in | 0.63 in | \$32.00 |
| 17752  | 3/4-16 UNF | 1.50 in | 0.90 in | 0.30 in | 6.00 in | 1.25 in | \$50.00 |

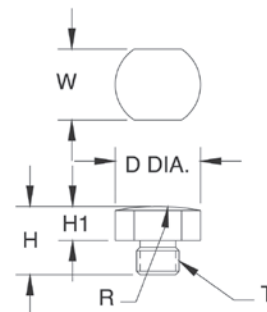

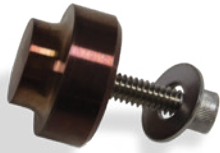

### Standard Features

#### Load Button Insert Kit

- To be used with RLSSB and VPG Revere SSB load cells (1,000 to 5,000 lb)
- Hardened alloy steel

### Part Number/Price

| Part # | Description            | Price   |
|--------|------------------------|---------|
| 26112  | Load button insert kit | \$37.00 |

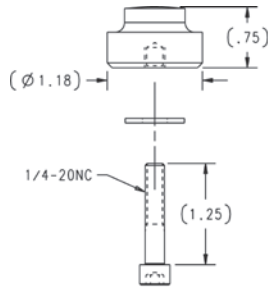

### Standard Features

- Replacement foot, adapts to most floor scales
- Use with single-ended beams to provide large, flat, adjustable introduction surface
- Special neoprene rubber sandwich base gives high accuracy, linearity and repeatability

### Part Number/Price

| Part # | Material        | Thread Size   | Base Ht. | Total Ht. | Diameter | Price    |
|--------|-----------------|---------------|----------|-----------|----------|----------|
| 18756  | Stainless steel | 1/2-20 UNF    | 0.75 in  | 2.62 in   | 3.47 in  | \$50.00  |
| 39021  | Mild steel      | 3/4-16 UNF-2B | 0.875 in | 3.25 in   | 4.40 in  | \$93.00  |
| 39022  | Mild steel      | 3/4-16 UNF-2B | 0.875 in | 4.06 in   | 5.40 in  | \$135.00 |
| 110930 | Mild steel      | 1-14 UNF      | 1.00 in  | 4.06 in   | 5.40 in  | \$235.00 |
| 42130  | Stainless steel | M12           | 0.75 in  | 2.62 in   | 3.47 in  | \$103.00 |

# Flintec® Adjustable Rubber Foot



SLB, SB4, SB5, SB14 and SB6



BK2

### Standard Features

- Blind hole introduction
- Low profile
- Height adjustable by rotation
- Includes spacer
- Stainless steel

### Part Number/Price

| Part #                             | Foot Diameter | Load Cell Capacity | Price   |
|------------------------------------|---------------|--------------------|---------|
| <b>SLB, SB4, SB5, SB14 and SB6</b> |               |                    |         |
| 46230                              | 2.36 in       | 200 to 500 lb      | \$65.00 |
| 77561                              | 3.14 in       | 1,000 to 5,000 lb  | \$65.00 |
| <b>BK2</b>                         |               |                    |         |
| 87096                              | 3.140 in      | 200 to 2,000 kg    | \$65.00 |

# Bench Scale Feet



107476



19141



35128

### Standard Features

- Rubber pad, 1/4-20 UNC thread
- Stainless steel, 3/8-16 UNC thread

### Part Number/Price

| Part #                 | Description       | Price   |
|------------------------|-------------------|---------|
| <b>Rubber Pad</b>      |                   |         |
| 35128                  | Bench scale feet  | \$14.00 |
| 107476                 | CW-90/CW-90X feet | \$21.00 |
| <b>Stainless Steel</b> |                   |         |
| 19141                  | Bench scale feet  | \$8.00  |

# Polyurethane Rubber Leveling Feet



## Standard Features

- Stainless steel stem for corrosion resistance
- Heavy-duty construction, low-cost replacement feet
- Four standard diameters all with 1/2-20 UNF stainless steel stud, slotted for top-access applications
- Stainless steel jam nut provided
- Top of stud is machined undersize 10% for easy alignment into load cell

## Part Number/Price

| Part # | Foot Diameter | Height  | Price   |
|--------|---------------|---------|---------|
| 74585  | 1.87 in       | 3.00 in | \$32.00 |
| 74586  | 2.00 in       | 3.00 in | \$32.00 |
| 74587  | 2.50 in       | 3.00 in | \$32.00 |
| 73801  | 3.00 in       | 3.00 in | \$32.00 |

# Captured Ball Floor Scale Leveling Feet



Carbon

Stainless Steel

## Standard Features

### Carbon steel

- Bright zinc and clear chromate plating for corrosion resistance
- Active ball suspension provides ideal load cell loading with maximum side load protection
- Hardened alloy steel with plated finish
- Includes one jam nut in carbon steel and stainless steel feet
- Top of stud is machined undersized 10% for easy alignment into load cell plus slotted for top-access applications

### Stainless steel

- Provides outstanding accuracy, repeatability and performance
- Active ball suspension provides optimal load cell performance
- Hardened stainless steel material, welded with polished finish
- Includes one jam nut in carbon steel and stainless steel feet
- Top of stud is machined undersized 10% for easy alignment into load cell plus slotted for top-access applications

## Part Number/Price

| Part #                 | Foot Diameter | Thread Size Inches | Height  | Price    |
|------------------------|---------------|--------------------|---------|----------|
| <b>Carbon Steel</b>    |               |                    |         |          |
| 74578                  | 1.87 in       | 1/2-20 UNF         | 3.50 in | \$45.00  |
| 74579                  | 2.00 in       | 1/2-20 UNF         | 3.50 in | \$45.00  |
| 74580                  | 2.50 in       | 1/2-20 UNF         | 3.50 in | \$45.00  |
| 74581                  | 3.00 in       | 1/2-20 UNF         | 3.50 in | \$45.00  |
| 74582                  | 3.00 in       | 3/4-16 UNF         | 4.50 in | \$56.00  |
| 74583                  | 3.00 in       | 1-12 UNF           | 4.50 in | \$67.00  |
| 74584                  | 3.00 in       | 1-14 UNF           | 4.50 in | \$67.00  |
| 171449                 | 3.00 in       | 1-14 UNF           | 5.00 in | \$83.00  |
| 173018                 | 4.40 in       | 3/4-16 UNF         | 3.13 in | \$96.00  |
| 174937                 | 5.40 in       | 3/4-16 UNF         | 4.13 in | \$139.00 |
| <b>Stainless Steel</b> |               |                    |         |          |
| 74572                  | 1.87 in       | 1/2-20 UNF         | 3.50 in | \$80.00  |
| 74573                  | 2.00 in       | 1/2-20 UNF         | 3.50 in | \$80.00  |
| 73800                  | 2.50 in       | 1/2-20 UNF         | 3.50 in | \$80.00  |
| 74574                  | 3.00 in       | 1/2-20 UNF         | 3.50 in | \$80.00  |
| 74575                  | 3.00 in       | 3/4-16 UNF         | 4.50 in | \$113.00 |
| 74576                  | 3.00 in       | 1-12 UNF           | 4.50 in | \$136.00 |
| 74577                  | 3.00 in       | 1-14 UNF           | 4.50 in | \$136.00 |
| 92380*                 | 2.50 in       | 1/2-20 UNF         | 3.50 in | \$80.00  |
| 175615                 | 3.47 in       | 1/2-20NF           | 2.62 in | \$108.00 |

\*Stem is fully threaded

# Leveling Pads

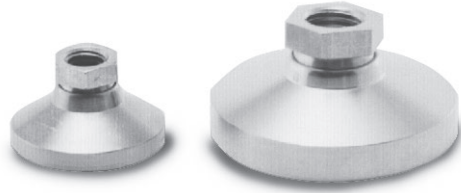

## Standard Features

- Replacement feet adapt to most floor scales
- Available in mild steel or stainless steel
- Simple swivel design
- Use with single-ended shear beams or bending beams to provide a large, flat load introduction surface

## Part Number/Price

| Part #                 | Thread Size | Height  | Diameter | Price    |
|------------------------|-------------|---------|----------|----------|
| <b>Mild Steel</b>      |             |         |          |          |
| 18817                  | 1/2-13 NC   | 1.12 in | 1.87 in  | \$27.00  |
| 18820                  | 3/4-10 NC   | 1.50 in | 3.00 in  | \$47.00  |
| <b>Stainless Steel</b> |             |         |          |          |
| 18818                  | 1/2-13 NC   | 1.12 in | 1.87 in  | \$63.00  |
| 18833                  | 3/4-10 NC   | 1.50 in | 3.00 in  | \$109.00 |

Used in conjunction with leveling pad stems

# Leveling Mount



## Standard Features

- Designed for use with some floor scales or machinery platforms
- Can limit vibrations transmitted to the scale through the floor
- Provides vibration isolation on most portable platforms

## Part Number/Price

| Part # | Thread Size | Height  | Diameter | Price    |
|--------|-------------|---------|----------|----------|
| 18819  | 1/2-13 NC   | 1.81 in | 5.00 in  | \$106.00 |

HARDWARE AND ACCESSORIES

# Leveling Pad Stems

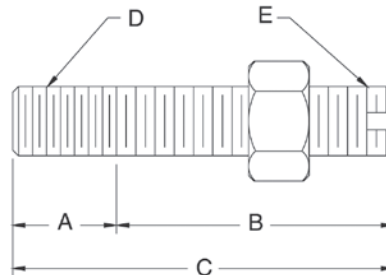

## Standard Features

- For use with leveling pads
- One jam nut included

## Part Number/Price

| Part #                 | A       | B       | C       | D          | E          | Slot | Material        | Price   |
|------------------------|---------|---------|---------|------------|------------|------|-----------------|---------|
| <b>Mild Steel</b>      |         |         |         |            |            |      |                 |         |
| 17693                  | 0.75 in | 2.00 in | 2.75 in | 3/4-10 UNC | 3/4-16 UNF | No   | 1045            | \$17.00 |
| <b>Stainless Steel</b> |         |         |         |            |            |      |                 |         |
| 17689                  | 0.50 in | 1.50 in | 2.00 in | 1/2-13 UNC | 1/2-20 UNF | Yes  | Stainless steel | \$25.00 |
| 17695                  | 0.75 in | 2.00 in | 2.75 in | 3/4-10 UNC | 3/4-16 UNF | No   | Stainless steel | \$40.00 |

Warning: Do not use to suspend a load

# RoughDeck® Scale Base

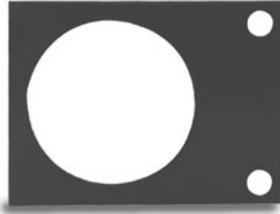

## Part Number/Price

| Part # | Description                         | Price   |
|--------|-------------------------------------|---------|
| 19075  | Mild steel, 1,000 to 10,000 lb      | \$19.00 |
| 19076  | Stainless steel, 1,000 to 10,000 lb | \$25.00 |

## Dimensions

| Part # | C       | C1      | H       | H1      | H2      | H3      | L       | L1      | L2      | W       |
|--------|---------|---------|---------|---------|---------|---------|---------|---------|---------|---------|
| 19075  | 3.62 in | 0.56 in | 4.50 in | 2.25 in | 0.50 in | 3.50 in | 6.00 in | 0.50 in | 3.75 in | 0.25 in |
| 19076  | 3.62 in | 0.56 in | 4.50 in | 2.25 in | 0.50 in | 3.50 in | 6.00 in | 0.50 in | 3.75 in | 0.25 in |

## Standard Features

- Secures RoughDeck and other popular floor scales
- Prevents movement in horizontal plane
- Useful with SureFoot™ and other load cell foot assemblies
- Available in stainless steel and mild steel

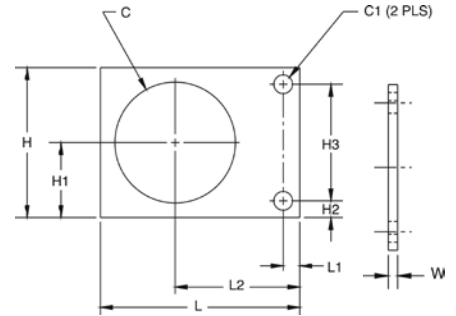

# Summit® 3000 Scale Base



## Part Number/Price

| Part # | Description                    | Price   |
|--------|--------------------------------|---------|
| 76149  | Mild steel, 2,000 to 10,000 lb | \$19.00 |

## Dimensions

| Part # | C       | C1      | H       | H1      | H2      | H3      | L       | L1      | L2      | W       |
|--------|---------|---------|---------|---------|---------|---------|---------|---------|---------|---------|
| 76149  | 3.19 in | 0.56 in | 4.50 in | 2.25 in | 0.50 in | 3.50 in | 6.00 in | 0.50 in | 3.75 in | 0.25 in |

## Standard Features

- Mounting plate for Summit 3000 floor scales

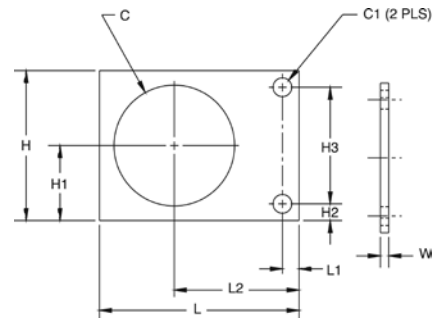

# Floor Scale Base

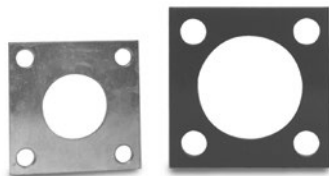

## Part Number/Price

| Part # | Description                         | Price   |
|--------|-------------------------------------|---------|
| 18737  | Mild steel, 1,000 to 10,000 lb      | \$9.00  |
| 18738  | Mild steel, 10,000 to 20,000 lb     | \$10.00 |
| 18751  | Stainless steel, 1,000 to 10,000 lb | \$34.00 |

## Dimensions

| Part # | C       | C1      | H       | H1      | H2      | H3      | L       | L1      | L2      | L3      | W       |
|--------|---------|---------|---------|---------|---------|---------|---------|---------|---------|---------|---------|
| 18737  | 2.00 in | 0.53 in | 4.00 in | 2.00 in | 0.50 in | 3.00 in | 4.00 in | 2.00 in | 0.50 in | 3.00 in | 0.25 in |
| 18738  | 3.25 in | 0.81 in | 5.00 in | 2.50 in | 0.75 in | 3.50 in | 5.00 in | 2.50 in | 0.75 in | 3.50 in | 0.38 in |
| 18751  | 2.00 in | 0.53 in | 4.00 in | 2.00 in | 0.50 in | 3.00 in | 4.00 in | 2.00 in | 0.50 in | 3.00 in | 0.25 in |

## Standard Features

- Suitable for use with leveling pads
- Generic mounting plate for popular floor scales
- Fits most floor scale foot assemblies
- Available in stainless steel and mild steel (mild steel parts are zinc plated/painted)

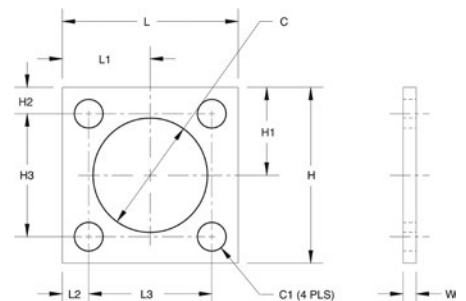

# Complete Custom Cable Services



## Specifications

### Jacket Material:

PVC  
Polyurethane  
Double-jacketed

### Conductors:

Unlimited number  
Twisted pairs  
Color code  
Gauge

### Shielding:

Braided  
Foil

### Jacket Colors:

Black, brown, green, orange, red, blue, yellow, gray, natural

### Ink Colors:

Black, white, silver, orange  
Custom logos

## Approvals



## Standard Features

- Special cable requirements
- Custom-built cable designed specifically for your application
- Choose from design elements and Rice Lake Weighing Systems will build a cable to your specifications
- Quick turnaround
- Competitively priced
- 5,000 ft minimum purchase

HARDWARE AND  
ACCESSORIES

# EL147, 6 Wire

Standard Load Cell Cable

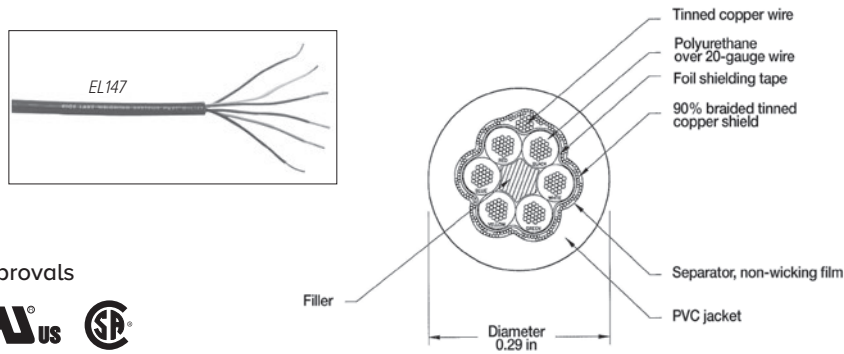

Approvals



## Standard Features

### EL147 Standard Cable

- 20 AWG tinned copper wire stranded for flexibility
- Braided shielding is encased in red PVC
- All conductors are industry-standard color-coded
- Diameter: 0.29 in
- The six-wire cable is best suited for longer runs where remote sense lines can be used
- Temperature rating:  
-22 °F to 126 °F (-30 °C to 80 °C)

## Part Number/Price

| Part # | Continuous Roll | Description         | Price      |
|--------|-----------------|---------------------|------------|
| 15515  | 100 ft          | Six-conductor cable | \$245.00   |
| 15516  | 250 ft          | Six-conductor cable | \$535.00   |
| 15517  | 500 ft          | Six-conductor cable | \$950.00   |
| 15518  | 1,000 ft        | Six-conductor cable | \$1,875.00 |
| 15495  | Custom length   | Six-conductor cable | \$2.45/ft  |

HARDWARE AND ACCESSORIES

# EL147RP Plus, 6 Wire

Rodent Protection Load Cell Cable

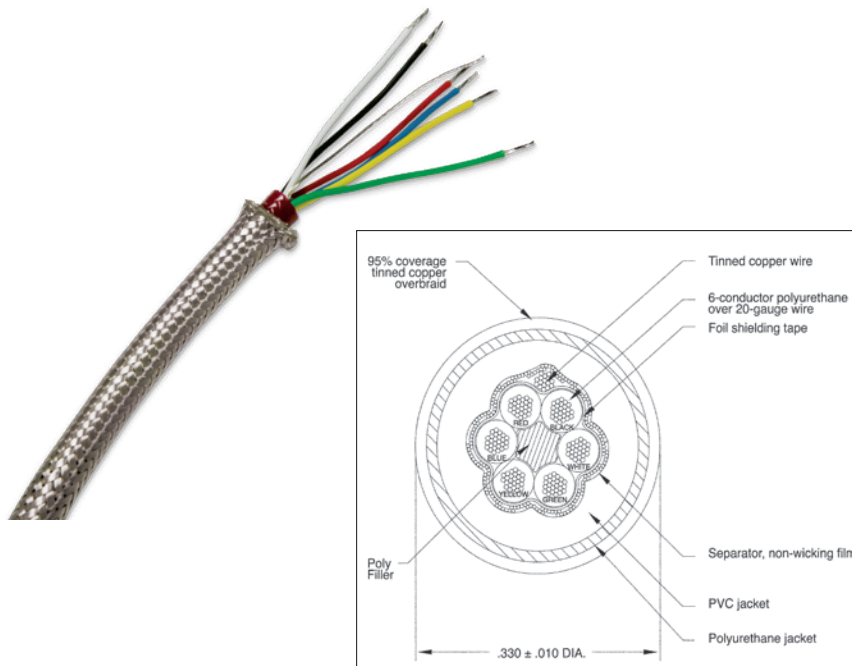

## Standard Features

### EL147RP Rodent Protection Cable

- Tinned copper overbraid provides superior rodent and abrasion deterrent
- Enhanced EMI/RFI protection
- Six-conductor industry-standard color-coded
- Ideal for truck and railroad-track scales
- Diameter: 0.33 in
- Temperature rating:  
-22 °F to 176 °F (-30 °C to 80 °C)
- Jacket coating enhanced with a chemical coating "NAW" that is distasteful to rodents

## Part Number/Price

| Part # | Continuous Roll | Description                           | Price      |
|--------|-----------------|---------------------------------------|------------|
| 31475  | Custom length   | Six-conductor rodent protection cable | \$4.25/ft  |
| 131964 | 100 ft          | Six-conductor rodent protection cable | \$415.00   |
| 131965 | 250 ft          | Six-conductor rodent protection cable | \$950.00   |
| 131966 | 500 ft          | Six-conductor rodent protection cable | \$1,875.00 |
| 131967 | 1,000 ft        | Six-conductor rodent protection cable | \$3,595.00 |

# EL147HE, 6 Wire

Hostile Environment Load Cell Cable

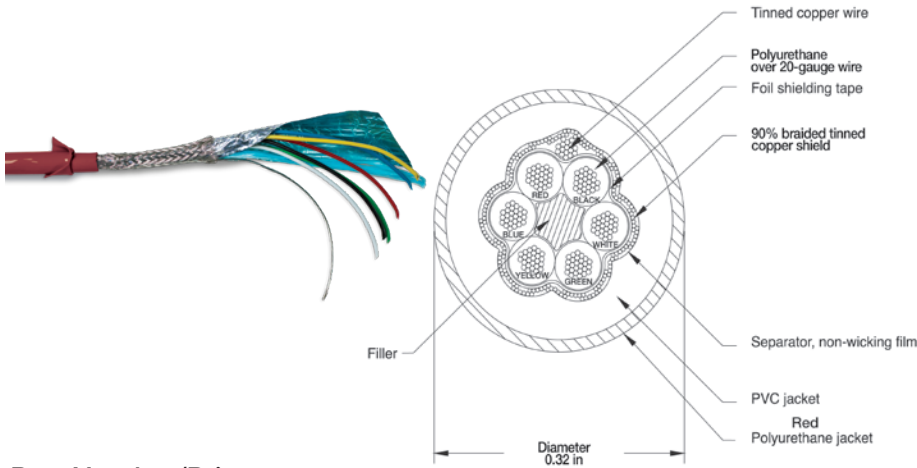

## Standard Features

### EL147HE Hostile Environment Cable

- Designed for use in hostile environments
- Polyurethane jacketing provides superior chemical and abrasion resistance
- RFI and EMI protected with foil overbraid shield
- Unmatched durability, yet extremely flexible
- All conductors are industry-standard color-coded
- Diameter: 0.32 in
- Temperature rating:  
-22 °F to 176 °F (-30 °C to 80 °C)

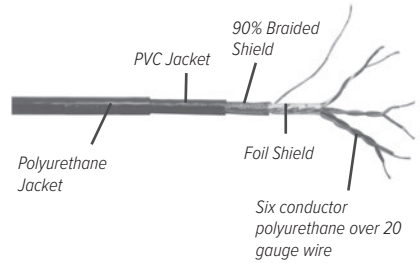

## Part Number/Price

| Part # | Continuous Roll | Description                             | Price      |
|--------|-----------------|---|------------|
| 15520  | 100 ft          | Six-conductor hostile environment cable | \$285.00   |
| 15521  | 250 ft          | Six-conductor hostile environment cable | \$675.00   |
| 15522  | 500 ft          | Six-conductor hostile environment cable | \$1,225.00 |
| 15523  | 1,000 ft        | Six-conductor hostile environment cable | \$2,125.00 |
| 15496  | Custom length   | Six-conductor hostile environment cable | \$2.95/ft  |

# EL147IS, 6 Wire

Hazardous Environment Blue Jacket Load Cell Cable

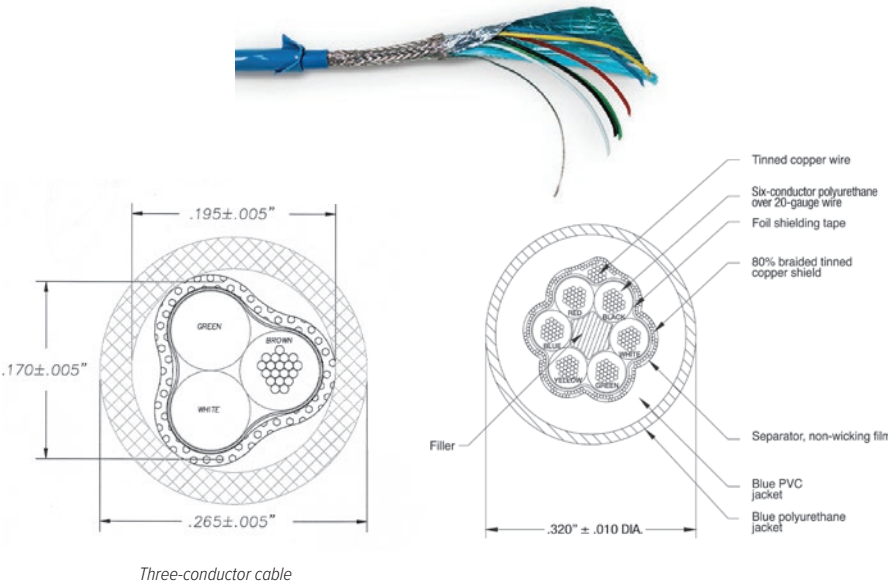

Three-conductor cable

## Standard Features

### EL147IS Hazardous Environment Blue Jacket Cable

- Designed for intrinsically safe applications (must be wired according to Factory Mutual System-approved diagram)
- Polyurethane over PVC double jacketing provides superior chemical and abrasion resistance
- Both foil and braided wire shields for added RFI and EMI protection
- Six-conductor is industry-standard color-coded (Also available three-conductor)
- Suited for longer runs where remote sense lines can be used
- Temperature rating:  
-22 °F to 176 °F (-30 °C to 80 °C)
- Diameter: 0.32 in

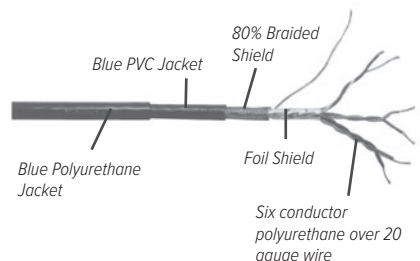

## Part Number/Price

| Part # | Description  | Price     |
|--------|--|-----------|
| 32817  | EL147IS, blue jacket six-conductor                           | \$3.65/ft |
| 72241  | Blue jacket, shielded three-conductor, UL and CSA recognized | \$3.15/ft |

HARDWARE AND ACCESSORIES

# EL146, 4 Wire

Standard Load Cell Cable

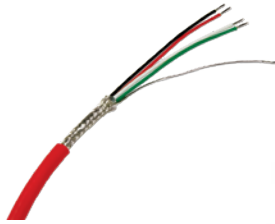

Approvals

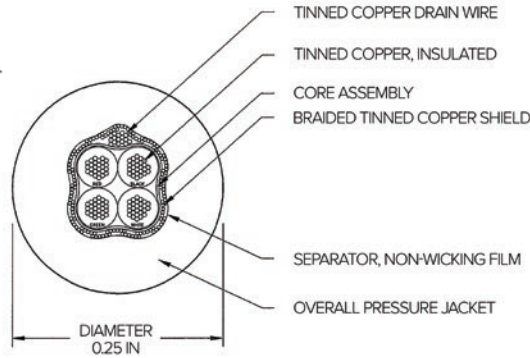

## Standard Features

### EL146 Standard Cable

- Four-wire load cell cable
- 20 AWG tinned copper wire stranded for flexibility
- Braided shielding is encased in red PVC
- All conductors are industry-standard color-coded
- Diameter: 0.25 in
- Use the four-wire cable for repairing or extending existing cable
- Temperature rating: -22 °F to 126 °F (-30 °C to 80 °C)

## Part Number/Price

| Part # | Continuous Roll | Description          | Price      |
|--------|-----------------|----------------------|------------|
| 15505  | 100 ft          | Four-conductor cable | \$155.00   |
| 15506  | 250 ft          | Four-conductor cable | \$375.00   |
| 15507  | 500 ft          | Four-conductor cable | \$725.00   |
| 15508  | 1,000 ft        | Four-conductor cable | \$1,150.00 |
| 15493  | Custom length   | Four-conductor cable | \$1.65/ft  |

HARDWARE AND ACCESSORIES

# EL146HE, 4 Wire

Hostile Environment Load Cell Cable

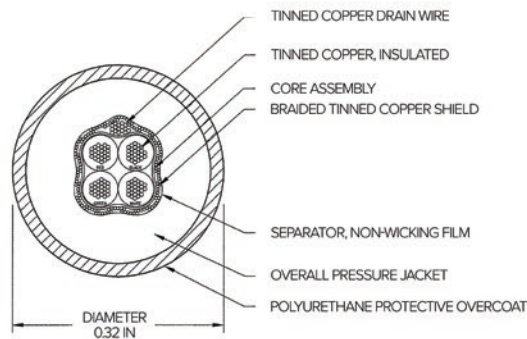
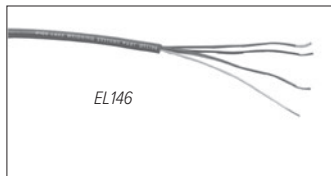

## Standard Features

### EL146HE Hostile Environment Cable

- Designed for use in hostile environments
- Polyurethane jacketing provides superior chemical and abrasion resistance
- RFI and EMI protected with foil overbraid shield
- Unmatched durability, yet extremely flexible
- All conductors are industry-standard color-coded
- Diameter: 0.32 in
- Temperature rating: -22 °F to 176 °F (-30 °C to 80 °C)

## Part Number/Price

| Part # | Continuous Roll | Description                              | Price      |
|--------|-----------------|--|------------|
| 15510  | 100 ft          | Four-conductor hostile environment cable | \$195.00   |
| 15511  | 250 ft          | Four-conductor hostile environment cable | \$465.00   |
| 15512  | 500 ft          | Four-conductor hostile environment cable | \$875.00   |
| 15513  | 1,000 ft        | Four-conductor hostile environment cable | \$1,750.00 |
| 15494  | Custom Length   | Four-conductor hostile environment cable | \$2.10/ft  |

# EL144 Communications Cable

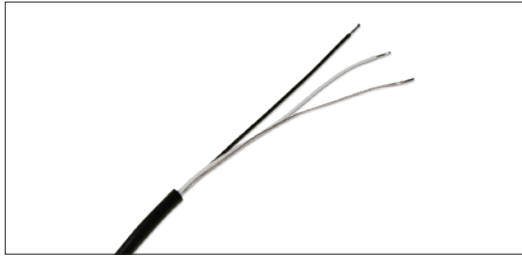

## Standard Features

- Two-conductor with bare ground
- RFI/EMI protected with foil shield
- 20 gauge conductors
- Perfect for RS-232, two-wire RS-485 and 20 mA current loop communications
- Diameter: 0.19 in
- Conductor colors are black and white

## Part Number/Price

| Part # | Description     | Price     |
|--------|-----------------|-----------|
| 32803  | EL144           | \$1.30/ft |
| 72691  | EL144, 100 ft   | \$115.00  |
| 72072  | EL144, 500 ft   | \$495.00  |
| 72693  | EL144, 1,000 ft | \$925.00  |

# BCD Cable

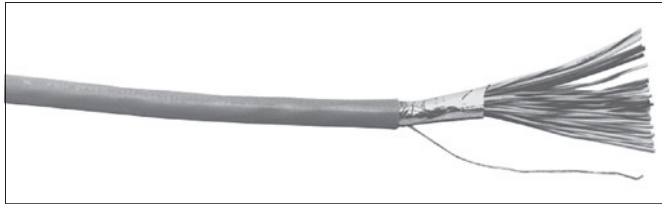

## Standard Features

- Sheathed in gray PVC
- Mylar aluminum foil shield with stranded tinned copper drain wire
- Diameter: 0.375 in

## Part Number/Price

| Part # | Description               | Price      |
|--------|---------------------------|------------|
| 15497  | BCD, 24 AWG, 30-conductor | \$35.00/ft |

HARDWARE AND ACCESSORIES

# Fiber-optic Cable



Color Code: Black-TXD, Blue-RXD

## Standard Features

- Duplex cable polyethylene black jacket material
- Plastic fiber core
- 4.4 + 0.10 mm outer diameter of duplex cable
- 2.2 + 0.007 mm single cable outer diameter
- Operating temperature: 32 °F to 158 °F (0 °C to 70 °C)

## Part Number/Price

| Part # | Description              | Price     |
|--------|--------------------------|-----------|
| 78910  | Custom length            | \$1.85/ft |
| 78026  | 100 ft cable             | \$185.00  |
| 78027  | 200 ft cable             | \$350.00  |
| 78028  | 300 ft cable             | \$447.00  |
| 83052* | Fiber-optic connector    | \$55.00   |
| 80892  | Fiber-optic cable cutter | \$15.00   |
| 85548  | Fiber-optic hot knife    | \$75.00   |

\*Duplex fiber cable requires two connectors

# SURVIVOR® EL620HE

High Temperature Cable



## Standard Features

- Multi-conductor overall foil and braid shield
- Suitable for temperatures from -40 °C (-40 °F) to 200 °C (392 °F)
- Insulation thickness: 0.010 in
- Jacket thickness: 0.017 in
- 18 gauge, tinned copper conductors
- Six-conductor
- FEP jacket, resistant to chemical corrosion and high temperature
- Aluminum-polyester shield with 85% tinned copper braid shield
- 150 V NEC 725 Class 2 classified for use in an air plenum non-conduit
- 0.24 in diameter cable

## Part Number/Price

| Part # | Description | Price      |
|--------|-------------|------------|
| 15605  | EL620HE     | \$17.00/ft |

# SURVIVOR® Cable Armor

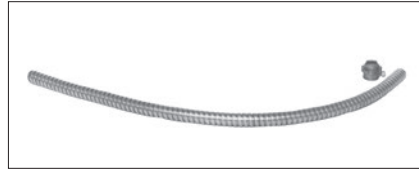

## Standard Features

- Flexible all-metal protective armor
- Ideal for protecting load cell cable from mechanical abrasion or rodents
- Available in stainless steel and galvanized steel
- 0.5 in internal diameter, 2.0 in minimum bend radius
- Optional end fitting with 1/2 in male pipe thread

## Part Number/Price

| Part # | Description          | Price       |
|--------|----------------------|-------------|
| 17808  | Galvanized steel     | \$4.75/ft   |
| 17806  | Stainless steel      | \$5.75/ft   |
| 17807  | Optional end fitting | \$2.85 each |

HARDWARE AND ACCESSORIES

# EL148HE Mettler Toledo®

Power Cell Replacement Cable



## Standard Features

- 100% stainless steel military connector-electro deposited nickel plating with stainless banding and epoxy heat-shrink strain relief
- Stainless steel arctic ring precision cut for improved connection
- Textured rubber boot for additional grip
- Standard Mettler Toledo color code
- Compatible with Mettler Toledo Powercell CMOS/NMOS and MTX load cells. NOT compatible with Mettler Toledo PDX load cells.
- Custom lengths available

## Part Number/Price

| Part # | Cable Length Each | Price    |
|--------|-------------------|----------|
| 100268 | 8 ft              | \$395.00 |
| 101102 | 12 ft             | \$415.00 |
| 104164 | 15 ft             | \$395.00 |
| 100269 | 26 ft             | \$435.00 |
| 100270 | 35 ft             | \$450.00 |

# Mettler Toledo® Power Cell®

Homerun Cable

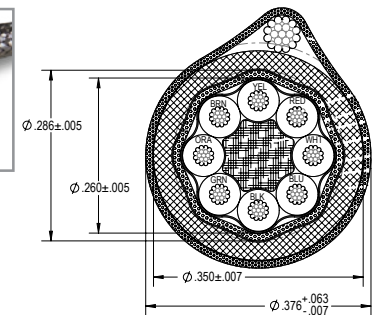

## Standard Features

- Galvanized steel drain wire
- 20 gauge 8 conductors
- Stainless steel braid shield

## Part Number/Price

| Part # | Description      | Price     |
|--------|------------------|-----------|
| 194837 | Galvanized steel | \$8.75/ft |

# Load Cell Conduit Adapters

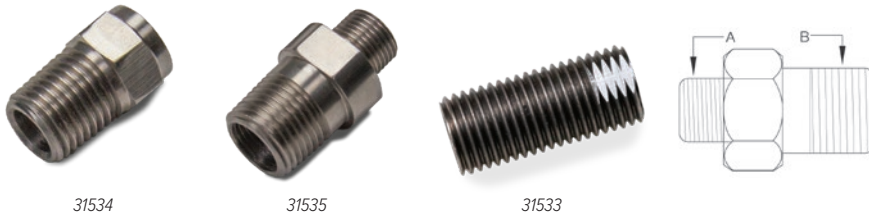

## Standard Features

- Used to adapt conduit to load cells
- 303 stainless steel

## Part Number/Price

| Part #           | A          | B          | Price   |
|------------------|------------|------------|---------|
| <b>Thread-On</b> |            |            |         |
| 31533            | 3/8-24 UNF | —          | \$40.00 |
| 31534            | —          | 1/4-18 NPT | \$40.00 |
| 31535            | 5/8-18 UNF | 1/2-14 NPT | \$40.00 |

Note: 31533 and 31534 are used together to form male-to-male adapter

# Cord Grip Assemblies

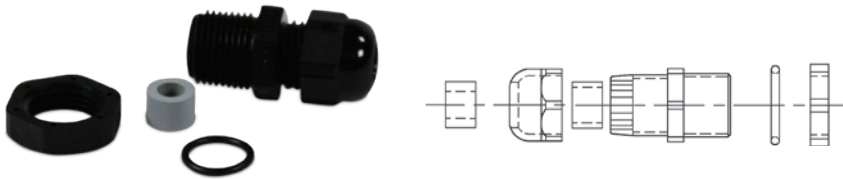

## Standard Features

- Assemblies include cord grip, locknut, O-ring seal, gray and black reducer glands
- Fittings are made of weather- and corrosion-resistant nylon

## Part Number/Price

| <b>Gland Cable Ranges</b> |         |                     |                   |                   |        |
|---------------------------|---------|---------------------|-------------------|-------------------|--------|
| Part #                    | Thread  | Panel Hole Diameter | Regular (Black)   | Reducer (Gray)    | Price  |
| 15669                     | PCN9    | 0.625 in            | 0.157 to 0.314 in | 0.118 to 0.236 in | \$5.50 |
| 15670                     | 3/8 NPT | 0.687 in            | 0.157 to 0.314 in | 0.118 to 0.236 in | \$5.00 |
| 15671                     | 1/2 NPT | 0.844 in            | 0.236 to 0.472 in | 0.200 to 0.354 in | \$5.75 |

HARDWARE AND ACCESSORIES

# EL214 Cable Splicing Kit



## Standard Features

### EL214

- Designed for a complete, professional transducer cable splice
- Prevents moisture from entering the load cell through the cable connector
- Each kit contains a high-impact plastic splicing box, liquid-tight cable fittings, circuit card, PTFE sleeving, pre-measured potting compound and complete instructions
- Solder terminals

## Specifications

### Dimensions:

(L × W × H)  
3.00 × 1.00 × 1.50 in

### Mounting Centers:

2.50 in

### Number of Connections:

Seven

### Cable Diameter:

0.187 to 0.312 in

### Cure Time For Potting:

Two hours at 73 °F (23 °C)

## Part Number/Price

| Part # | Description | Price    |
|--------|-------------|----------|
| 15485  | EL214       | \$155.00 |

# EL214T Cable Splicing Kit



## Standard Features

### EL214T

- Designed to accommodate cables larger than the EL214; all other dimensions and performance features are the same
- Solder terminals

## Specifications

### Dimensions:

(L × W × H)  
3.00 × 1.00 × 1.50 in

### Mounting Centers:

2.50 in

### Number of Connections:

Seven

### Cable Diameter:

0.187 to 0.312 in

### Cure Time For Potting:

Two hours at 73 °F (23 °C)

## Part Number/Price

| Part # | Description | Price    |
|--------|-------------|----------|
| 15486  | EL214T      | \$210.00 |

# EL215 Cable Splicing Kit



## Standard Features

- Designed for use in weather-exposed or direct-burial locations
- Each kit contains plastic splicing tube, circuit board, insulating resin and instructions
- Solder terminals

## Specifications

### Dimensions:

(L × W)  
6.00 × 1.38 in

### Number of Connections:

7

### Cable Diameter:

Up to 0.75 in

### Cure Time For Potting:

2 hours at 70 °F (21 °C)

## Part Number/Price

| Part # | Description | Price    |
|--------|-------------|----------|
| 15612  | EL215       | \$250.00 |

# Flintec® Load Cell Cable

Replacement Kits



## Standard Features

- Each kit includes cable for four Flintec SB4 load cells as listed

## Part Number/Price

| Part # | Description                  | Cable Length Ea. Feet | Price    |
|--------|------------------------------|-----------------------|----------|
| 18412  | For SB4, 225 to 5,200 lb     | 10 ft                 | \$385.00 |
| 18413  | For SB4, 11,250 to 22,500 lb | 15 ft                 | \$415.00 |

## Five-Position Connectors, Shell Plugs, Receptacles



## Six-Position Connectors, Shell Plugs, Receptacles



## Seven-Position Connectors, Shell Plugs, Receptacles

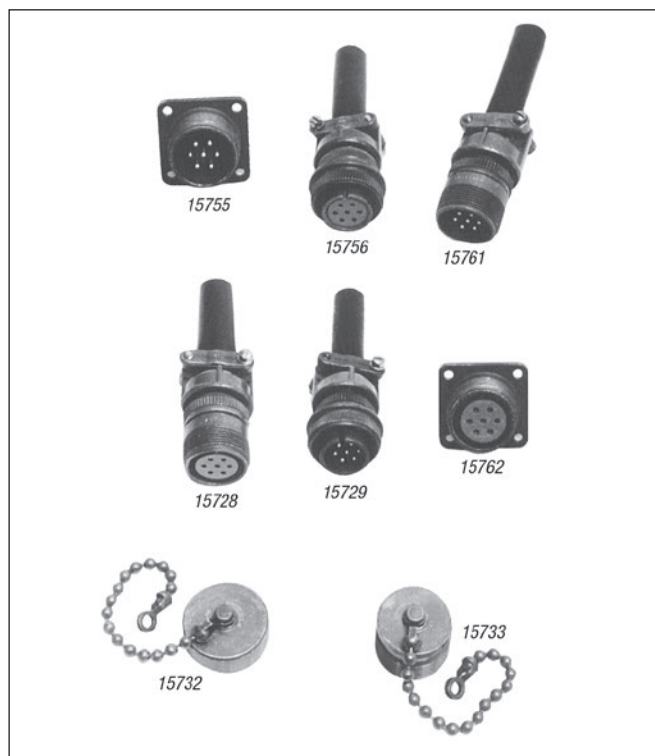

### Part Number/Price

| Part # | Description   | Price   |
|--------|---|---------|
| 15753  | Five-pin, external thread   | \$35.00 |
| 15722  | Five-socket, internal thread  | \$36.00 |
| 15723  | Five-pin, internal thread   | \$35.00 |
| 15757  | Five-socket, external thread  | \$40.00 |
| 15754  | Five-pin chassis mount, external thread   | \$40.00 |
| 15758  | Five-socket chassis mount, external thread  | \$26.00 |
| 15730  | Dust cap for ext. thread five-position connector  | \$17.00 |
| 15731  | Dust cap for int. thread five-position connector  | \$22.00 |
| 15759  | Six-pin, external thread, male  | \$35.00 |
| 60124  | Six-socket, internal thread connector, female fits Toledo load cells, Condec indicators | \$30.00 |
| 15727  | Six-pin, internal thread, male  | \$34.00 |
| 15724  | Six-socket, external thread   | \$38.00 |
| 15726  | Six-pin chassis mount, external thread  | \$27.00 |
| 15760  | Six-socket chassis mount, external thread   | \$26.00 |
| 15730  | Dust cap for ext. thread six-position connector   | \$17.00 |
| 15731  | Dust cap for int. thread six-position connector   | \$22.00 |
| 15761  | Seven-pin, external thread  | \$36.00 |
| 15756  | Seven-socket, internal thread   | \$38.00 |
| 15729  | Seven-pin, internal thread  | \$38.00 |
| 15728  | Seven-socket, external thread   | \$38.00 |
| 15755  | Seven-pin chassis mount, external thread  | \$27.00 |
| 15762  | Seven-socket chassis mount, external thread   | \$30.00 |
| 15732  | Dust cap for ext. thread seven-position connector                                       | \$23.00 |
| 15733  | Dust cap for int. thread seven-position connector                                       | \$34.00 |

# T-Grip Molding

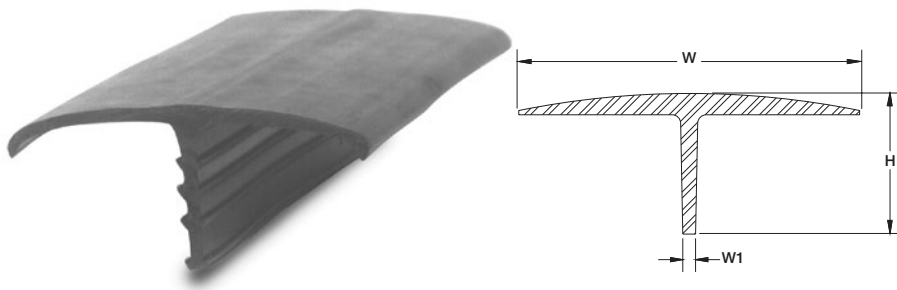

## Standard Features

### T-Grip

- Designed for use in truck scale applications to prevent spillover into the pit
- Impact, tear and weather-resistant EPDM rubber
- Barbed web to hold molding in place
- Web thickness 0.22 in
- Available by the foot: 10 ft, 11 ft, 70 ft, 80 ft and 100 ft lengths
- Maximum continuous length is 450 ft

## Part Number/Price

| Part # | H       | W       | W1      | Length           | Price      |
|--------|---------|---------|---------|------------------|------------|
| 18799  | 2.56 in | 5.75 in | 0.22 in | Sold by the foot | \$13.00/ft |
| 18800  | 2.56 in | 5.75 in | 0.22 in | 10 ft            | \$100.00   |
| 18801  | 2.56 in | 5.75 in | 0.22 in | 11 ft            | \$110.00   |
| 18802  | 2.56 in | 5.75 in | 0.22 in | 70 ft            | \$795.00   |
| 33219  | 2.56 in | 5.75 in | 0.22 in | 80 ft            | \$895.00   |
| 33222  | 2.56 in | 5.75 in | 0.22 in | 100 ft           | \$1,125.00 |
| 234302 | 2.56 in | 5.75 in | 0.22 in | 250 ft           | \$2,800.00 |
| 234303 | 2.56 in | 5.75 in | 0.22 in | 450 ft           | \$5,500.00 |

Note: Maximum continuous length is 450 ft. Call for price and availability.

# T-Strip Molding

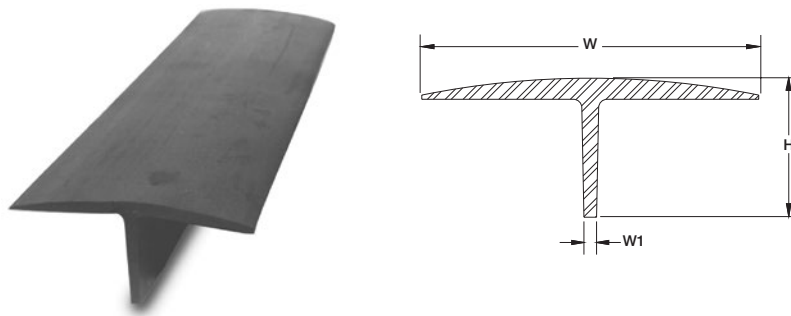

## Standard Features

### T-Strip

- Designed for use in truck scale applications to prevent spillover into the pit
- Impact, tear and weather-resistant SBR rubber
- Web thickness 0.25 in
- Available by the foot: 10 ft, 11 ft, 70 ft, 80 ft and 100 ft lengths
- Maximum continuous length is 450 ft

## Part Number/Price

| Part # | H       | W       | W1      | Length           | Price      |
|--------|---------|---------|---------|------------------|------------|
| 18736  | 2.00 in | 4.50 in | 0.25 in | Sold by the foot | \$12.00/ft |
| 18776  | 2.00 in | 4.50 in | 0.25 in | 10 ft            | \$95.00    |
| 18797  | 2.00 in | 4.50 in | 0.25 in | 11 ft            | \$105.00   |
| 18798  | 2.00 in | 4.50 in | 0.25 in | 70 ft            | \$695.00   |
| 33223  | 2.00 in | 4.50 in | 0.25 in | 80 ft            | \$825.00   |
| 33224  | 2.00 in | 4.50 in | 0.25 in | 100 ft           | \$1,025.00 |

Note: Maximum continuous length is 450 ft. Call for price and availability.

# Electronic Scale Tickets

## Standard Features

### Hecon® Printers, EL522 & EL516 - 20266

- Triplicate interleaved
- Size (L × W): 7.875 × 4.25 in (200 × 127 mm)
- Order quantity: 500 per package
- Carbonless

20266

## Standard Features

### SP2200, SP2000 - 20265

- Triplicate interleaved, perforated and glued on one end
- Size (W × L): 5.5 × 9 in (139.7 × 228.6 mm)
- Order quantity: 500 per package
- Carbonless

20265

## Standard Features

### Rice Lake Scales - 71630 or 105182

- Duplicate or triplicate
- Size (W × L): 4.25 × 7 in (107 × 177.8 mm)
- Attached at 4.25 side
- Order quantity: 500 per package
- Custom (duplicate): Add company name (min. order two packs)
- Custom (triplicate): Add company name (min. order two packs)
- Carbonless

## Standard Features

### Blank Scale Ticket - 22263

- Triplicate
- White, canary yellow and pink
- Size (L × W): 5.50 × 4.25 in (140 × 108 mm)
- Attached at 4.25 edge
- Order quantity: 100 per package
- Custom: Add company name (min. order of 1,000)
- Carbonless

HARDWARE AND ACCESSORIES

## Part Number/Price

| Part # | Description   | Price        |
|--------|---|--------------|
| 20266  | Hecon printers, EL522 & EL516, 500/pack                           | \$121.00     |
| 20265  | SP2200, SP2000, EL250 & EL500, 500/pack                           | \$125.00     |
| 71630  | Rice Lake ticket, two part, 500/pack                              | \$66.00      |
| 105182 | Rice Lake ticket, three part, 500/pack white, canary yellow, pink | \$95.00      |
| 22263  | Blank scale ticket, 100/pack                                      | \$28.00 each |

# Mechanical Scale Tickets

## Standard Features

### Fairbanks Scales® - 20260

- Carbonless triplicate with 2 in (50.8 mm) tear-off flap
- Size (W × L): 4.75 × 1.875 in (120.7 × 47.6 mm)
- Order quantity: 500 per package

| WEIGHED ON A FAIRBANKS SCALES |                        | No.                              |
|-------------------------------|------------------------|----------------------------------|
| Load _____                    | Date _____             | Received by                      |
| From _____                    |                        |                                  |
| Gross _____ lbs.              | To _____               |                                  |
| Tare _____ lbs.               | Address _____          |                                  |
| Net _____ lbs.                | Price _____ Amt. _____ |                                  |
| On _____                      | Off _____              | Weigher _____                    |
| <small>Form 333A</small>      |                        | <small>Printed in U.S.A.</small> |

## Standard Features

### Howe Scales - 20261

- Carbon triplicate with 2 in (50.8 mm) tear-off flap
- Size (W × L): 5.5 × 1.75 in (139.7 × 44.5 mm)
- Order quantity: 500 per package

| Weight obtained by using THE HOWE PATENTED RECORDING BEAM |                    | No.           |
|---|--------------------|---------------|
| From _____  | To _____           | Received by   |
| Gross _____   | Load of _____      |               |
| Tare _____  | Driver { On _____  |               |
| Fees _____  | Off _____          |               |
| Net _____   | Date _____ 20 ____ |               |
|   |                    | Weigher _____ |

## Part Number/Price

| Part # | Description                | Price   |
|--------|----------------------------|---------|
| 20260  | Fairbanks Scales, 500/pack | \$86.00 |
| 20261  | Howe Scales, 500/pack      | \$86.00 |

## Create Your Own Custom Ticket

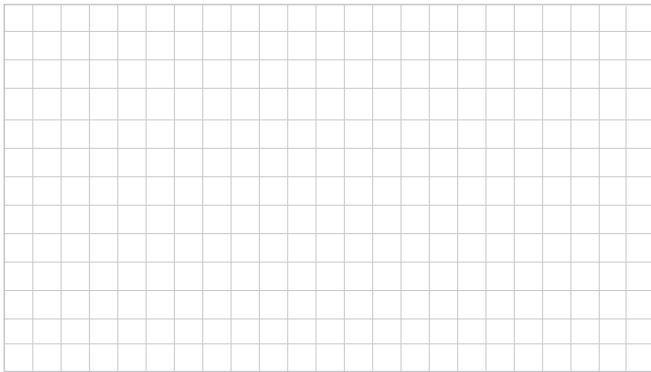

Send us a copy of the existing custom format or drawing of a completely new one. Please specify number of carbon copies, dimensions, colors and text. Minimum order quantity may apply.

HARDWARE AND ACCESSORIES

# Printer Dust Covers

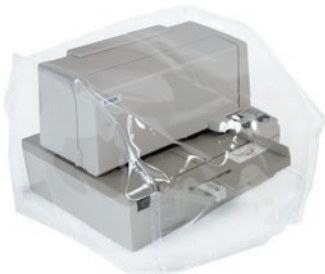

Protect your electronic scales, weight indicators and printers with a scale veil or printer dust cover.

## Standard Features

- Tough, flexible transparent vinyl, constructed with heavy-duty stitching
- Loose fit allows for operation of switches or controls through the dust cover
- Available for most types of scale equipment

## Part Number/Price

| Part #           | Model                      | Price   |
|------------------|----------------------------|---------|
| <b>EPSON®</b>    |                            |         |
| 29582            | TM290/295                  | \$58.00 |
| 35666            | TM-U200 TM-U220            | \$63.00 |
| 111840           | TM-U590                    | \$69.00 |
| <b>Oki-Data®</b> |                            |         |
| 21208            | Oki-Data 184 Turbo Printer | \$65.00 |
| 21226            | Oki-Data 320/390           | \$65.00 |

Custom covers and specials available; consult factory.

# Printer Cables



72440



156806 (1m)

156807 (3m)

156808 (5m)

## Part Number/Price

| Part #  | Description   | Price   |
|---|---|---------|
| <b>Interface Cables for TicketPress, SP-2200, TM-U295, TM-U590 and Star® Printers</b> |   |         |
| 15547   | Blunt end, 25-pin D-sub male RS-232 serial interface cable                        | \$70.00 |
| 15548   | 25-pin D-sub male to 25-pin D-sub male 20 mA serial interface cable (SP2200 only) | \$70.00 |
| 15568   | 25-pin D-sub male to 25-pin D-sub male RS-232 serial interface cable              | \$70.00 |
| Consult   | Custom 20 mA/RS-232 serial interface cable  | \$95.00 |
| <b>Interface Cables for I-Class</b>   |   |         |
| 15547   | Blunt end, 25-pin D-sub male RS-232 serial interface cable                        | \$70.00 |
| Consult   | Custom RS-232 interface cable   | \$95.00 |
| <b>Interface Cables for Desktops, GoDEX Models, Zebra, E-4203 and M-4206</b>          |   |         |
| 41276   | DB9 male RS-232 cable to blunt end  | \$77.00 |
| <b>Straight Cable</b>   |   |         |
| 70056   | DB9 male to DB9 female  | \$40.00 |
| 50749   | DB9 female to DB9 female  | \$66.00 |
| 41279   | DB25 male to DB9 male   | \$70.00 |
| 72440   | DB25 male to DB9 female   | \$67.00 |
| <b>Null Modem Cable</b>   |   |         |
| 66535   | DB9F to DB9 female, Null modem  | \$48.00 |
| 64794   | DB9 male to DB9 female  | \$69.00 |
| <b>USB Cable</b>  |   |         |
| 79074   | USB-A (male) to USB-B (male) cable, 6 ft  | \$35.00 |
| 156806  | USB-A (male) to USB-A (male) cable, 1 m   | \$35.00 |
| 156807  | USB-A (male) to USB-A (male) cable, 3 m   | \$50.00 |
| 156808  | USB-A (male) to USB-A (male) cable, 5 m   | \$60.00 |
| 156809  | USB-A (male) to USB-B (male) cable, 1 m   | \$55.00 |
| 156815  | USB-A (male) to USB-B (male) cable, 3 m   | \$55.00 |
| 156811  | USB-A (male) to USB-B (male) cable, 5 m   | \$70.00 |
| <b>Ethernet Cable/RJ45</b>  |   |         |
| 72697   | RJ45 to RJ45, 7 ft  | \$40.00 |
| 78860   | RJ45 to RJ45, cross over 7 ft   | \$44.00 |
| 75594   | RJ45 to nine-pin female   | \$70.00 |
| 156817  | RJ45, 1 m   | \$35.00 |
| 156818  | RJ45, 3 m   | \$42.00 |
| 156821  | RJ45, 5 m   | \$50.00 |
| <b>Misc. Cables and Adapters</b>  |   |         |
| 22436   | Blunt end, nine-pin D-sub female  | \$77.00 |
| 130213  | Blunt end DB25 male   | \$64.00 |
| 165698  | Female to male gender changer   | \$11.25 |
| 119064  | Slimline, Null modem gender changer, DB9 female/female                            | \$14.00 |
| 130789  | Null modem DB9 M/F  | \$16.00 |



156817 (1m)

156818 (3m)

156821 (5m)

HARDWARE AND ACCESSORIES

Blunt-end cables interface to: UMC444, UMC555, UMC600, IQ700, IQ plus® 310A, IQ plus® 355, IQ plus® 390-DC, IQ plus® 510, IQ plus® 590-DC, IQ plus® 710, IQ plus® 800, and IQ plus® 810, 520 and 920i®

Custom cables are designed to interface with your specific equipment. Please specify equipment model number and connector type. Standard cable length is 5 ft.

# Static Brushes



| Part # | Staticmaster Part # | Description           | Price    |
|--------|---------------------|-----------------------|----------|
| 76669  | 1C200               | Static brush 1 in     | \$194.00 |
| 76670  | 1C200R              | Replacement cartridge | \$125.00 |



| Part # | Staticmaster Part # | Description           | Price    |
|--------|---------------------|-----------------------|----------|
| 76671  | 3C500               | Static brush 3 in     | \$294.00 |
| 76672  | 3C500R              | Replacement cartridge | \$198.00 |

# Ionizing Strips



| Part # | Staticmaster Part # | Description                             | Price    |
|--------|---------------------|---|----------|
| 76677  | 1U400               | Ionizing unit 1 x 1 in 500 microcurries | \$217.00 |
| 76678  | 1U200               | Ionizing unit 1 x 1 in 250 microcurries | \$125.00 |
| 76676  | 2U500               | Ionizing unit 1 x 3 in                  | \$228.00 |

# Ionizing Strip Accessories

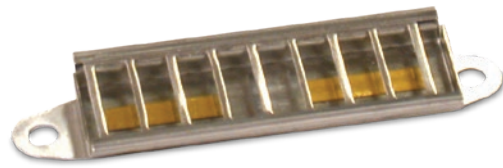

| Part # | Staticmaster Part # | Description                         | Price    |
|--------|---------------------|-------------------------------------|----------|
| 76679  | BF1                 | Ionizer positioner                  | \$131.00 |
| 76680  | BF2                 | Ionizer positioner only - C bracket | \$147.00 |

HARDWARE AND ACCESSORIES

# Desiccants



## Standard Features

- Packets
- Bagged desiccants to protect your enclosed electronic components from moisture and humidity
- Useful in junction boxes, indicators and all scale electronics

## Part Number/Price

| Part # | Description               | Price  |
|--------|---------------------------|--------|
| 16038  | Mini Pax® 7 g             | \$1.30 |
| 16039  | NatraSorb® 20 g           | \$2.30 |
| 92240  | Silica gel 1 unit pkg 3 g | \$1.20 |

# Industrial Corrosion Inhibitor



## Standard Features

- Special chemical combination provides superior protection
- Protects 5 cubic ft/1.4 cubic m of enclosure volume for approximately one year
- Dimensions: (W x H) 2.5 x 1.5 in (64 x 38 mm)

## Part Number/Price

| Part # | Description         | Price   |
|--------|---------------------|---------|
| 16037  | Corrosion inhibitor | \$45.00 |

# Crimper and Lead Seals



## Standard Features

### Crimper

- 5.0 in (127 mm) seal press with two 0.5 in (13 mm) engraving dies
- Chrome finish
- Maximum number of characters that can be engraved on die is nine
- Compound leverage
- Quick delivery on custom dies

### Lead Seals

- Heavy-duty seal with galvanized steel wire
- Length 16.0 in (406 mm)

## Part Number/Price

| Part # | Description                      | Price    |
|--------|----------------------------------|----------|
| 231916 | Crimper die                      | \$67.00  |
| 21111  | Crimper and two die blanks       | \$155.00 |
| 15318  | Crimper die blank (replacements) | \$67.00  |
| 15317  | 100 seals/pkg                    | \$60.00  |

# Static Control Wrist Strap



The single most important personal accessory for protecting ESD sensitive components and circuits, this wrist strap protects against charges from the body. The wrist strap consists of a comfortable elastic cuff or band and a detachable conductive cord for grounding the wrist band.

## Part Number/Price

| Part # | Description                | Price   |
|--------|----------------------------|---------|
| 34263  | Static control wrist strap | \$62.00 |

# Static Shielding Bags



This static shield bag offers total ESD protection, whether you're transporting ESD-susceptible products across the room or across the country. The outer layer of the bag consists of an abrasion-resistant polyester, while the antistatic polyethylene inner layer retards triboelectric static charging from inside the bag.

## Part Number/Price

| Part # | Description                       | Price       |
|--------|-----------------------------------|-------------|
| 16150  | Static shielding bags, 8 × 10 in  | \$1.20 each |
| 16151  | Static shielding bags, 12 × 18 in | \$3.50 each |

# Static-safe Service Kit

HARDWARE AND  
ACCESSORIES



## Standard Features

- Eliminates static for safe board replacement
- Connects a field service technician and the static-safe work surface to the same ground point
- Harmlessly drains static charges from the body and from any conductive objects placed on the mat
- Folds into a compact unit for transport and storage

## Part Number/Price

| Part # | Description             | Price    |
|--------|-------------------------|----------|
| 32818  | Static-safe service kit | \$215.00 |

# Rice Lake's Scale Technician Kits

Take Rice Lake's commitment to customer service into the field. Rice Lake's Scale Technician Kit has everything you need in one convenient backpack to troubleshoot and repair wherever you are.

## PN 166205 Technician Tool Kit \$1,050.00

- Rice Lake backpack
- Simulator with vernier
- Digital volt meter
- Communication Kit



## PN 166204 Communication Kit \$175.00

- Cinch sack
- Document Kit
- Six-in-one screwdriver
- Small RLWS screwdriver
- Test LEDs
- USB to serial converter
- DB9M to DB9F straight cable
- DB9F to blunt end cable
- DB25M to blunt end cable
- Female to female DB9 null modem adapter
- Female to male DB9 gender changers
- Null modem adapter
- TCP/IP patch cable
- TCP/IP crossover cable



## PN 166203 Document Kit \$10.50

- Pinouts for a DB9 and DB25 cable shows both male and female connectors
- Pinouts and color codes for a patch and crossover Ethernet cable
- Recommended maximum cabling distances of RS-232, 20mA, 485 and Ethernet TCP/IP
- Standard ASCII chart in both decimal and hexadecimal
- Links to website to download latest version of Revolution® and iRev® (on CD)
- Link to freeware terminal program download (PUTTY, Hercules, RealTerm, etc.)
- Load cell color wire chart
- Weigh Modules and Vessel Weighing Handbook PN 43918
- Load Cell and Weigh Module Handbook PN 22054



## PN 118432 Small Screwdriver \$4.00



HARDWARE AND ACCESSORIES