

RD-300/RD-232

Remote Displays

Version 2.1

Installation/Operation Manual



Contents

- 1.0 Introduction..... 1**
 - 1.1 Scale Indicator Formats 2
 - 1.1.1 Standard Software 2
 - 1.1.2 Standard Hardware..... 2
 - 1.1.3 Optional Hardware 2

- 2.0 Installation..... 3**
 - 2.1 Mounting 3
 - 2.2 Electrical Service Connections 4
 - 2.2.1 All Models - AC - Service..... 4
 - 2.2.2 DC Models Voltages 6.2 - 18 VDC 4
 - 2.3 Indicator Setup..... 5
 - 2.4 Serial Data Inputs 8
 - 2.4.1 RS-232 C - SW2-8 Off 8
 - 2.4.2 20 mA Active Current Loop - SW2-8 On 9
 - 2.4.3 20 mA Passive Current Loop - SW2-8 On..... 9
 - 2.4.4 Configuring the RD-300/RD-232 10
 - 2.5 Powering up With the RD-300/RD-232 13

- 3.0 Mounting Procedure for Panel Mount RD-300/232 15**

- 4.0 Appendix 19**
 - 4.1 RD-300 Replacement Parts 19
 - 4.2 RD-232 Replacement Parts 19

1.0 Introduction

The RD-300 is a high performance serial remote data display. It receives digital indicator serial data signals through either 20 mA Current Loop or RS-232C, and displays weight data on a high contrast, 1" LCD. Status indicators are provided for LB, Kg, g, GROSS, NET, OZ, PCS, TN, ZERO, and additional specialty annunciators for COUNT, TOTAL S1, S2, S3, S4, UNDER, OVER, and OK. The RD-300 supports 15 popular serial scale formats plus a special "Smart Receiver" for indicators not listed. Custom interfaces to other indicators or instruments are available. The RD-300 is direct-sunlight readable. It features black characters on a silver reflective background, and is ideal for outdoor applications from 40°C to -25°C (104°F to -13°F). The RD-300 can monitor up to four scales (S1, S2, S3, S4), and is available for either AC or DC power.

The following diagram illustrates the front panel of an RD-300 remote display.

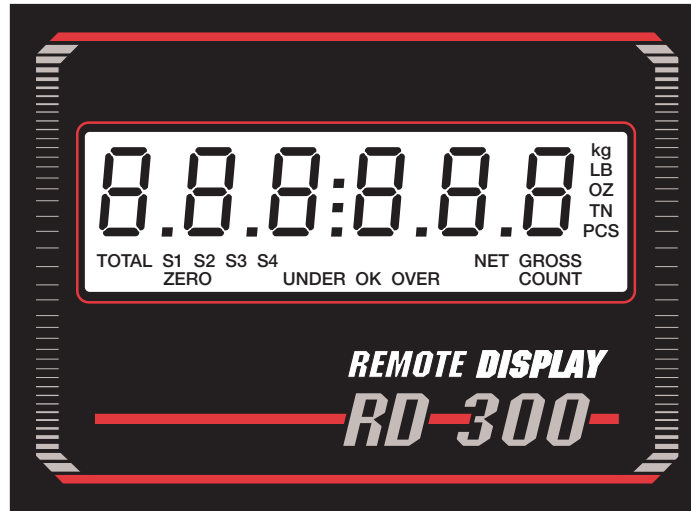

The RD-232 is a high performance serial remote data display designed for indoor use. It displays weight data on a high contrast 0.8" LED. Status indicators are provided for LB, Kg, GROSS, and NET. The RD-232 supports 15 popular serial scale formats plus a special "Smart Receiver" for indicators not listed. Custom interfaces to other indicators or instruments are available. The RD-232 features bright red characters and is ideal for indoor display applications from 40°C to -25°C (104°F to -13°F).

The following diagram illustrates the front panel of an RS-232 remote display.

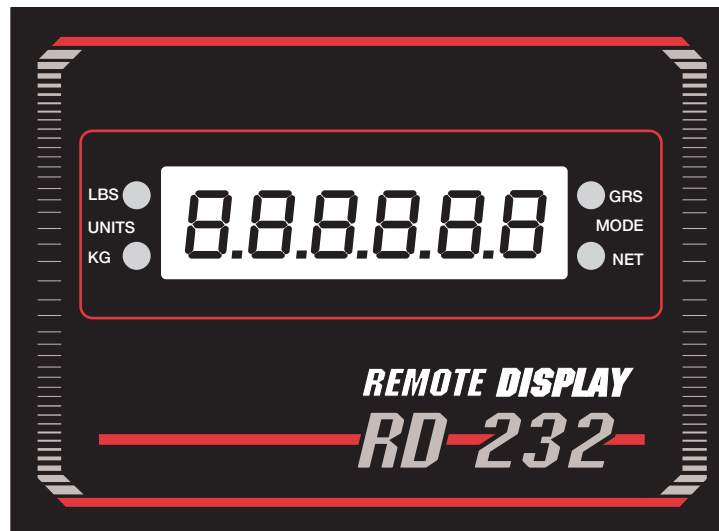

1.1 Scale Indicator Formats

Rice Lake IQ plus 310, IQ plus 800/810 use 20 mA Current Loop only for the RD-300/RD-232.

- Rice Lake IQ 700
- Rice Lake UMC Series
- A&D Instruments 4322, 4323, 4316, 5000
- Weightronix WI-110, WI-120, WI-125, and WI-130
- Toledo Indicators with high-speed data format
- Masstron M-2500 and M-5000
- Flex-Weigh DWM-4
- Analogic AN5315, AN5316, and AN5322 (use 20 mA current loop only for the RD-300/RD-232)
- Fairbanks 90-164 series and meters with continuous scoreboard outputs
- Doran indicators Model 4100 and 4200
- Cardinal 738 and 748
- GSE 450/550 meters
- Sartorius balances with RS-232 continuous serial outputs
- Hardy 2151 indicators
- Computers, PLCs, or terminals with programmable ASCII
- Special generic Smart Receiver

1.1.1 Standard Software

The standard software for the RD-300 or RD-232 receives and displays serial data from 15 different types of scale indicators. The receiver can accept either RS-232C or a 20 mA active or passive current loop. The standard unit also re-transmits the data via a 20 mA active current loop. The data is transmitted either “as received” or in a Condec continuous serial format at the incoming baud rate.

1.1.2 Standard Hardware

The standard RD-300 or RD-232 is comprised of a single circuit board housed in a JIC standard 8" X 6" Fiberglass Reinforced Plastic (FRP) enclosure that is NEMA 4X rated.

Standard units are powered by either 117 VAC 50/60 Hz line power or DC voltages of 8.2 - 18 VDC. Voltages as low as 6.0 VDC can be used to power the unit with the addition of one jumper.

1.1.3 Optional Hardware

Both the RD-300 and RD-232 can be ordered in a stainless steel NEMA 4X enclosure, an explosion-proof NEMA 7CD, 9EFG, 4-enclosure panel mount, or as a board-only product for OEM applications. Consult the factory for alternate enclosures.

An optional long-life LCD backlight is available for the RD-300. The LCD color is yellow/green and has a rated life of 100,000 hours.

2.0 Installation

The following section describes the installation procedures used with the RD-300/RD-232.

2.1 Mounting

The standard NEMA 4X enclosure is a JIC standard 8" X 6" pattern. It is approximately 8" high, 9.5" wide, 5.25" deep, and weighs 4 lb. Mounting is via four mounting holes on 8.75" horizontal by 4" vertical centers. Use 1/4" hardware (not furnished) and mount the enclosure securely. The enclosure is hinged on the bottom side of the box. The installation environment is not critical, but the RD-300/RD-232 should be located as far as practical from major sources of electromagnetic interference (EMI) or radio frequency interference (RFI). Also, care must be taken to ensure that the front panel display is easily visible.

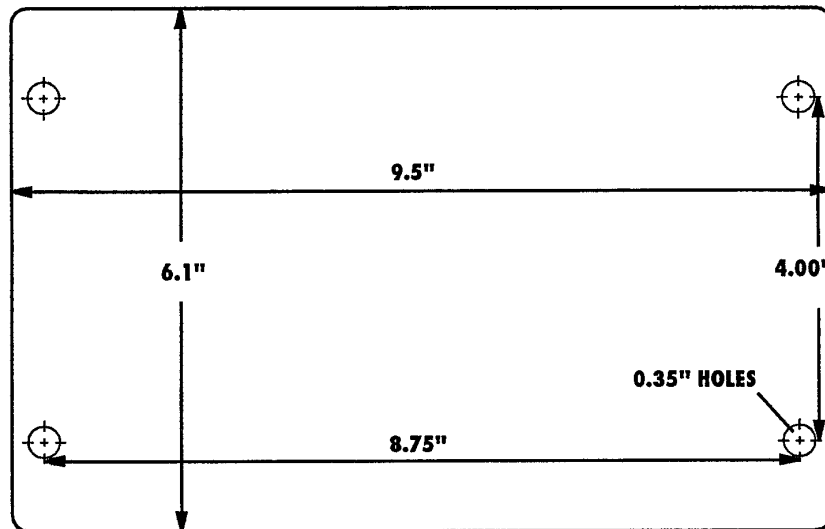

Figure 2-1. RD-300 Mounting Footprint

2.2 Electrical Service Connections

2.2.1 All Models - AC - Service

You will need a source of 117 VAC \pm 10% 60 Hz, 1 Phase to power the RD-300/RD-232. The standard unit has an 8' #18-3 AWG polarized line cord. This can be plugged into a standard duplex receptacle if the RD-300/RD-232 is used in a dry area. If the environment around the RD-300/RD-232 is wet or dirty, use a "Bell Box" or other gasketed receptacle or hard wire the AC directly to the RD-300/RD232. The cord grip furnished is mounted in a hole suitable for 3/8" NPT fittings.

If you hard wire power to the RD-300/RD-232, you will use the three position connector marked TB-1 (shown in Figure 2-2). Connect the L1 (Black or Hot) wire to terminal #1, the right hand terminal nearest the fuse. Strip the wire approximately 3/16". Use a small screw driver or ball point pin to press the white latch release. While holding the lever down, insert the wire and release the lever. Pull on the wire to assure a good connection. You must use #14 AWG or smaller wire. Strip and insert the L2 (white or neutral) wire into TB1-3. Pull on the wire to assure a good connection. Strip and insert the ground (green) wire into TB1-2. Pull on the wire to assure a good connection.

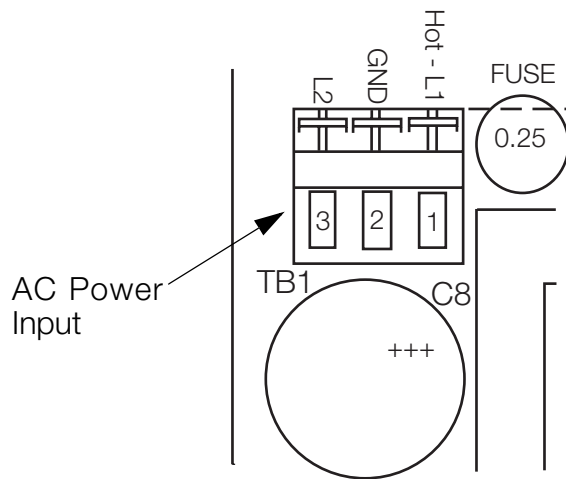

Figure 2-2. AC Power on Input TB1



Caution

To prevent injury or product damage, do not turn on the power yet. Wait until you have successfully worked through this manual and reached the section Powering Up the RD-300.

2.2.2 DC Models Voltages 6.2 - 18 VDC

The RD-300/RD-232 will also work on DC power. To use a DC power source between 10 and 18 VDC, connect the + DC source to terminal TB2-1 and the DC- source to terminal TB2-2 as shown in Figure 2-3. The current requirement is 30 mA without the backlight option and 160 mA with the LED backlight. If the unit has no backlight installed, then it will work with voltages of 6.6-24 VDC without modification. If the optional backlight is installed on the RD-300, the operating voltage range is 8.2 to 18 VDC without modification. Consult the factory for other voltages.

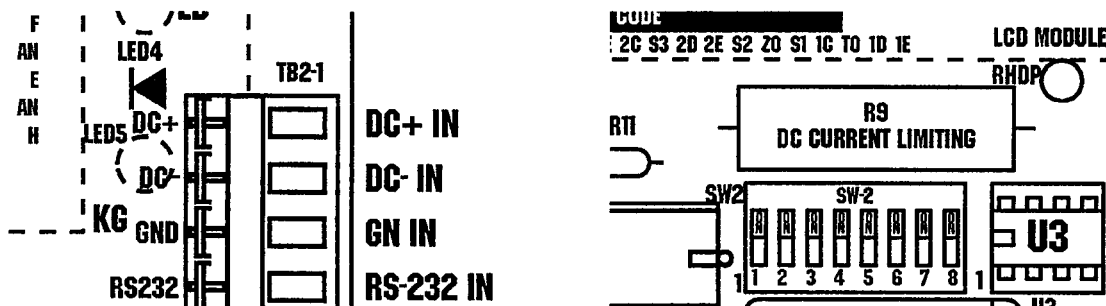

Figure 2-3. DC Voltage Settings

2.3 Indicator Setup

Determine what indicator will supply the data to the RD-300/RD-232. Once determined, there are certain setup parameters which you will need to know. Common indicators are discussed below.

- Rice Lake IQ series (600-700), IQ plus series (810 and 310*) - All of the IQ and IQ plus series indicators work with the setup for continuous output and have the Consolidated Controls output. The IQ plus 810 set in the stream mode has the same format as the Condec indicators. The IQ plus 310 can match the format of several indicators: CARDINAL 738, WI 120, AN 5316, the Toledo Hi-Speed output, and Consolidated Controls (Condec). Match the baud rate you wish to use and program this into the RD-300/RD-232. Baud rates from 300 to 19,200 are supported. If the meter you are using has a selectable bit pattern, the preferred is 1 start bit, 8 data bits, and no parity. The RD-300/RD-232 will, however, receive 7 data bit patterns of any parity as well.
- Condec, Rice Lake IQ plus 310* - All models in the Consolidated Controls line should be set up for continuous output. Any baud rate from 300 to 38,400 is supported. Condec meters will work with either the Universal or Condec setting.
- AND Instruments 4322,4321,4316, - These indicators can be set up for either "current loop" (passive) or "RS232", using the "stream mode" at 2400 baud, Format 1. The RS-232 can be used with either the Universal receiver or the AND setting. The passive current loop input requires the current supply from the current loop output.
- AND Instruments Model 5000 - This indicator can supply either RS-232 or 20 mA active current loop. Configure port two to transmit continuously in the Condec format. Use the Condec setting for this meter.
- Weigh-Tronix 110 and 120 meters - with continuous data outputs - These indicators can be set up for either "current loop" or "RS232", in the continuous mode. Baud rates from 300 - 38,400 are supported. Both new and old data formats are supported.

Note: a special EPROM may be required from Weigh-tronix for the required continuous serial output. Use the Universal mode or the Weigh-tronix setting with these indicators. Switch 7 can be used to control unwanted time out if very slow update rates are chosen.

- Weigh-Tronix Models WI-125 - Connect the RS-232 signals (TB2-1 is ground and TB2-2 is transmit data) to the RD-300/RD-232. Set the Serial String to Auto = ON and Broad = ON. Layout - 1=Display, 2=ASCII -13-10-3-End, End. Set the baud rate to match the baud rate selected in the meter.
- Weigh-Tronix Models WI-130 - There are two ports, one and two. Port one uses either RS-232 or RS-485. Port two uses either 20 mA current loop or RS-232. Select one of the two ports. Set handshaking to off. You must program a BASIC program to get the meter to send the data continuously.

Use the following steps to set up a basic ticket string.

1. Program the string as: <G OR N><SP><7 WEIGHT BYTES><SP><LB OR KG><SP><CR><LF>
2. Use the sample program given below:

```
Under system setup-
Set Timer (2,0.5); set timer 2 to 0.5 seconds
SUB SYSTEM Timer2
If Actvalue=0 then
GN$="G"
SVAL$=GROSS
else
GN$="N"
SVAL$=NET
end if
IF UNIT=0 then
LK$="LB"
else
```

```

LK$="KG"
end if
DO L
IF KEN(SVAL$)<7 then
SVAL$= " " +SVAL$
else
exit DO
end if
LOOP

```

```
DISPSTR$ =GN$ + CHR$(32) + SVAL$ + CHR$(32) + LK$ + CHR$(32) + CHR$(13) + CHR$(10)
```

```
PRINT #1 DISPSTR$;PRINT TO PORT #1 (#2 FOR PORT 2)
```

- Toledo Indicators (with high speed data format) - Most Toledo indicators support this format. Older indicators can only be set up as “current loop” (active) at 4800 baud. RS-232 and 20 mA current loops are supported. Baud rates of 300 - 19,200 may be used. Use the Toledo receiver for these meters.
- Flex-Weigh DWM-4 - This indicator can be set up for either “current loop” (active or passive) or “RS232”, using “MODE 1 - Status, Weight, Tare Data”. Baud rates of 300 - 19,200 may be used. Set the data preamble to “FF, FF, FF” and the postamble to “FF, FF, FF”. The LB/KG units display does not function with this meter. Use the Flex-Weigh receiver for this meter.
- Analogic AN5315, AN5316, AN5322, Rice Lake IQ plus 310* - These indicators can be set up for “current loop” in the continuous mode. Do not use “RS-232.” Baud rates of 300 - 19,200 can be used. This meter supports the grams and tons display mode. Use the Analogic receiver mode for these meters.
- Masstron M2500, M5000, Toledo meters with this output (814X) - These indicators are set up for 4800 baud via the continuous remote display output normally used with Masstron accessories. This meter supports the grams and tons mode. Use the Masstron receiver for these meters.
- Fairbanks 90-164 - This indicator is set up for 1200 baud “current loop” via Port “C”. Enable the Lampbank output in the continuous mode. Other Fairbanks meters such as the 90-167 will work with the RD-300/RD-232 if they have continuous data outputs. Use the Fairbanks receiver for these meters.
- Streeter Amet 9000 - This indicator is set up for “current loop”. The baud rate can be 1200, 2400, or 4800. **Do not use 9600 baud!** Program the output for Gross/Net Weight as 01/10/00 or in the print program for 03/10/00. Use the Universal receiver for this meter.
- Cardinal 738 and 748, Rice Lake IQ plus 310* - These indicators can be set up for either the “current loop” or “RS232”, using the “computer” setting (S3=10001010). The baud rate can be 1200, 2400, 4800, or 9600. This meter supports the tons display annunciator. Use the Cardinal interface for these meters.
- Doran Indicators and Scales - Models 4100 and 4200 are supported. Use either port one or two in either RS-232 or 20 mA current loop mode. Set the selected output port for continuous data and print format #11.

Note: *The RD-300/RD-232 does not support the lbs and ounces mode!*

- GSE 450/550 - Models 450 and 550 are supported. A sample program and port configuration is shown below:
RS-232
Printer Port - RS-232 or current loop
COM port - RS-232 with no handshake
Set number of characters transmitted per number to 8 <P208.08>

Example:

P210.02 - Sets custom transmit 1 to continuous

P211.01 - Sets custom transmit 1 to send through the printer port

Send a custom transmit. Set for continuous transmission mode and the port selected.

Set up custom transmit 1:

1000ASCII - 02

1001DISPLAY DATA - 98

1002STATUS DATA - 97

1003ASCII - 03

The serial data is as follows:

<02><8 WEIGHT BYTES><SP><LB OR KG><SP><GROSS OR NET SP SP><STAT><SP><M OR O OR SP><03>

- Sartorius Balances with RS-232 data output - RS-232 is supported. Set for space parity, 1 stop bit, auto output print without stability, no ID code, and software handshake. The output data must use the 16 character format.
- Hardy 2151 - Configure the standard serial port for RS-232. You must hardware jumper the RTS to the CTS pins even if the software handshake is enabled. Select the baud rate and eight data bits with no parity. To send the gross weight continuously, program *G* - - - - into the output parameter value. To send the net weight continuously, program *N* - - - - into the output parameter value.
- Universal Data Receiver - This receiver can receive serial data in a wide variety of intuitive formats. It can be used in either RS-232 or current loop. Use when all else fails. This receiver keys on carriage returns (CR), end of text (ETX), or end of transmission (EOT) characters in the data string. The receiver looks for *G*, *g*, *N*, *n*, *K*, *k*, *L*, *l*, (-) characters and reconstructs the data string from this information. When the RD-300/RD-232 senses that the universal receiver has been selected, use switch SW2-6 to tell the unit if the serial string contains a kilogram sign as a *K* or a *KG*. The universal receiver always looks at the data string from back to front. This keeps the receiver from confusing the “g” in kg with a g for gross mode. If the string uses a single character for kilograms, SW2-6 should be OFF.
- Other Indicators... Many indicators have programmable serial outputs and can be programmed to work with the RD-300/RD-232, if , and only if, the output formatting exactly matches what the display has been programmed to accept. If a computer or terminal is going to be used with an RD-300/RD-232, the universal format is probably the easiest to use if the data is sent continuously. Several other meters have been interfaced for use with the RD-300/RD-232. Consult the factory for special application needs.
- Choices- Some meters have multiple outputs. Some can have two or more RS-232 outputs or current loop outputs which can be active or passive. The preferred interface is an active current loop from the meter. RS-232 is always the least desirable because the ground planes of the two devices must be tied together. The output data must be continuous. Demand ports are mostly unusable unless the meter uses the universal, Condec, Fairbanks, or Cardinal formats. If a demand format must be used or the display must show the last data transmitted, SW2-4 can be used to disable display timeout. Turn SW2-4 ON to disable display timeout.

*IQ plus 310 has multiple data formats and can be used with multiple receivers

2.4 Serial Data Inputs

The RD-300/RD-232 can accept serial ASCII data sent in RS-232C, or 20 mA active or passive current loop formats. To select an RS-232 input signal, Set SW2-8 OFF. To use any current loop signal, set SW2-8 ON. See Figure 2-4. These formats determine the electrical way that data is transmitted. This has nothing to do with what data is sent.

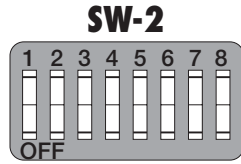

Figure 2-4. Switch Setting SW-2

The RD-300/RD-232 can read the data transmission strings sent by 15 of the more popular scale indicator families. It cannot read data from meters not included in this list unless you use universal mode or the formatting exactly matches one on the list (or you have a custom program). Set up the RD-300 on the bench with the meter you intend to use before taking it to the installation site.



Caution

Some indicators are built with their RS-232 serial port signal ground combined with the general chassis ground. When the RD-300 or RD-232 Remote Displays are connected to such an indicator sending RS-232, half of the power supply is being shorted to chassis ground via the offending RS-232 signal ground connection. The result is extreme heat in the transformer and premature failure.

With Analogic indicators and other products combining RS-232 signal ground and chassis ground, do not use RS-232 output. Set both the indicator output and the remote display input to 20 mA current loop instead.

Check your indicator's electrical schematics—or feel for extreme heat at the RD-300/RD-232 transformer—to determine if your indicator has a combined RS-232 signal and chassis ground. If so, use 20 mA current loop.

2.4.1 RS-232 C - SW2-8 Off

Data is transmitted as a voltage and alternates between +10 VDC and -11 VDC. Hybrid “RS-232” signals can swing between other voltage ranges as long as the positive swing is greater than 4 VDC and the negative is less than -1VDC. RS-232 is ground referenced and therefore, connects the ground planes of the sending and receiving instruments. RS-232 should never be run more than 50'. It may work, but it may not work well all the time. Long RS-232 data cables can act as a conduit for lightning or other electrical noise to the instrument. If you need longer cable runs, use a 20 mA current loop. If this is not available on your indicator, consider an optically isolated protocol convertor to change the RS-232 to 20 mA loop and optically isolate the ground planes of the two instruments.

Connect RS-232 wiring as shown in Figure 2-5 (RS-232, GND). Strip the wires approximately 3/16". Press on the white lever to open the connector. Insert the wire and release the lever. Test the tightness by gently pulling on the wires. Tighten the strain relief fitting around the RS-232 cable with a wrench or pliers.

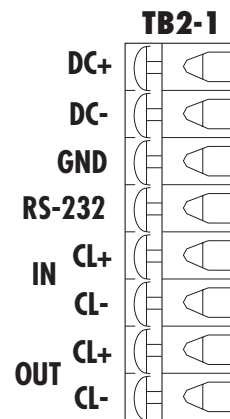

Figure 2-5. RS-232 Wiring Assignment

2.4.2 20 mA Active Current Loop - SW2-8 On

In this mode data is transmitted as a current and is passed through an optical isolator. This current causes an LED to emit light onto a phototransistor, which converts this light into a TTL signal. Current transmission can be made over long distances and is quite immune to transient surges or RFI/EMI noise. The distance a current loop can transmit is limited by the voltage source available to the current loop and the speed of transmission which data is sent. The maximum baud rate is set by the quality of the indicator transmitter. The RD-300/RD-232 can receive data at baud rates of up to 38,400.

An active current loop means that the instrument which sends the data also supplies the voltage to power the loop. This voltage can be as small as 3.5 VDC to as much as 24 VDC. When the loop goes through an optocoupler, a “drop” occurs. This drop is about 2 VDC. A current loop can power as many drops as there is voltage to power the loop. For example, if a current loop is powered by 5 VDC, it can normally drive two “drops”. If the same loop were powered by 24 VDC, it could power about 11 remote displays or other devices. Determine that your indicator has an active current loop and connect it as shown in figure 6. Strip the incoming wires approximately 3/16". Press on the white lever to open the connector. Insert the wire and release the lever. Test the tightness by gently pulling on the wires. Tighten the strain relief fitting around the serial data cable with a wrench or pliers.

The 20 mA receiver in the RD-300/RD-232 is an HP-4200 high speed current loop receiver. The photo coupler and requires current swings of less than 4 mA as a mark and greater than 12 mA for a space. The output of both the RS-232 and the current loop is sent through an LED on the circuit board. See Figure 2-6. This LED will be OFF when nothing is connected to the board, and will flash when serial data is being received. Please note that when the LED flashes, it means that something is being received that looks like a serial signal. It does not guarantee that the signal is correct.

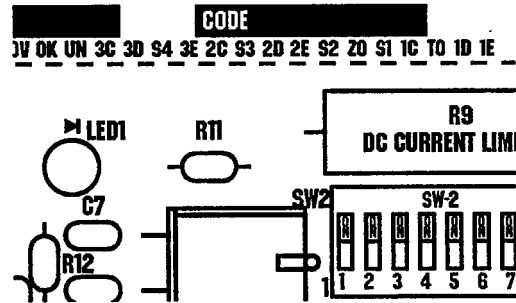

Figure 2-6. LED Location

2.4.3 20 mA Passive Current Loop - SW2-8 On

A passive current loops means that the instrument which sends the data does not supply the voltage source to power the loop. The voltage must come from the RD-300/RD-232. To use a passive current loop, wire the unit in the following way.

1. Jumper TB2-3 to TB2-6 (Gnd to CL- IN).
2. Connect the CL+ from the meter to the CL+ Output (TB2-7) and the CL- Output to TB2-5 (CL+ IN).
3. Strip the incoming wires approximately 3/16".
4. Press on the white lever to open the connector.
5. Insert the wire and release the lever.
6. Test the tightness by gently pulling on the wires.
7. Tighten the strain relief fitting around the serial data cable with a wrench or pliers.

Note: Using this configuration changes the current loop output to a passive transmitter!

2.4.4 Configuring the RD-300/RD-232

The RD-300/RD-232 must be properly configured. To do this, you must know:

- Which indicator?
- What Baud Rate?
- How does the display handle a loss of signal?
- Are you going to use the universal mode?
- Do you want to retransmit data in Condec format or in the format it was received?

Once this information is known, it is entered through SW1 and SW2, DIP switches on the CPU board. (See Figure 2-7, and table below).

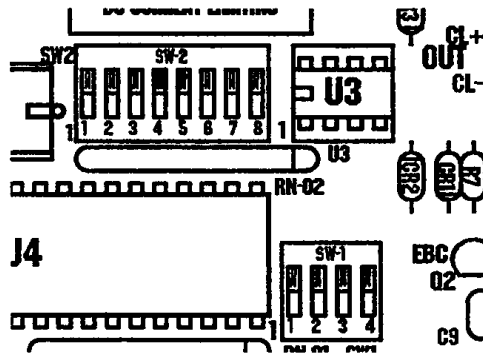

Figure 2-7. DIP Switch Settings

Meter Number	Receiver	SW1-1	SW1-2	SW1-3	SW1-4
0	Universal	On	On	On	On
1	IQ plus, Condec	On	On	On	Off
2	Toledo	On	On	Off	On
3	Flex-Weigh	On	On	Off	Off
4	Analogic	On	Off	On	On
5	Fairbanks	On	Off	On	Off
6	Cardinal	On	Off	Off	On
7	Masstron	On	Off	Off	Off
8	AND	Off	On	On	On
9	Weigh-tronix	Off	On	On	Off
10	Spare	Off	On	Off	On
11	Doran	Off	On	Off	Off
12	Sartorious	Off	Off	On	On
13	GSE	Off	Off	On	Off
14	Hardy	Off	Off	Off	On
15	Spare	Off	Off	Off	Off

Table 2-1. DIP Switch Settings

Enter the baud rate from the table listed below.

Baud Rate	SW2-1	SW2-2	SW2-3
38,400	On	On	On
19,200	Off	On	On
9,600	On	Off	On
4800	Off	Off	On
2400	On	On	Off
1200	Off	On	Off
600	On	Off	Off
300	Off	Off	Off

Table 2-2. Baud Rate Settings

Select the interface type, RS-232 or 20 mA with SW2-8.

Input Type	SW2-8
20 mA CL	On
RS-232	Off

Table 2-3. Interface Type

Note:

IF YOU ARE USING TOLEDO, MASSTRON, FLEX-WEIGH, OR ANALOGIC (or IQ plus 310 IN ANALOGIC MODE) METER SETTINGS, USE THE FOLLOWING SWITCH DATA

Toledo, Flex-Weigh, Analogic, and Masstron meters all transmit data continuously. They also have special information available in their formatting which allow the RD-300/RD-232 to perform additional useful functions. With these meters, the timeout function is always enabled. SW2-4,5,6 and 7 have the following meanings:

Retransmit Data Format	SW2-4
Condec data format	On
As received	Off

Table 2-4. SW2-4 Data Format Settings

Display on Time Out	SW2-5
"No sig"	On
Last data received	Off

Table 2-5. SW2-5 Time Out Settings

Displayed Weight Mode	SW2-6	SW2-7
Current displayed weight	On	On
Gross weight only	Off	On
Net weight only	On	Off
Tare weight only	Off	Off

Table 2-6. SW2-6/7 Displayed Weight Settings

The RD-300/RD-232 will display the data selected by SW2-6 and 7 regardless what is showing on the scale indicator.

IF YOU ARE USING ANY OTHER METER SETTING, USE THE FOLLOWING SWITCH DATA ON PAGE 12.

Other meters may transmit data intermittently, slowly, or in a demand mode where the data is only sent once. Enabling the time out function causes the RD-300/RD-232 to do the following. If new data hasn't been received for approximately two seconds, then the display shows what is selected by SW2-5, either the last valid weight or all dashes. If no valid data is received after ten seconds, the RD-300/RD-232 initiates a power on reset, clear all data, read the switches, and waits for new data. For these meters SW2-4,5,6 and 7 have the following meanings:

Time Out Enable	SW2-7
Time out counter disabled (cn dis)	Off
Time out counter enabled (cn ena)	On

Table 2-7. SW2-7 Time Out Enabled Setting

Display on Time Out	SW2-5
"No sig"	On
Last data received	Off

Table 2-8. SW2-5 Time Out Settings

Universal KG Character Type	SW2-6
A single character is sent, K, k	Off
KG, Kg, or kg is sent	On

Table 2-9. SW2-6 Character Type Settings

Retransmit Data Format	SW2-4
Condec data format (rd con)	On
As received (rd rec)	Off

Table 2-10. SW2-4 Data Format Settings

2.5 Powering up With the RD-300/RD-232

Make sure all wiring is per the manual and is properly terminated.

APPLY POWER-

The RD-300/RD-232 enters the power on clear mode. All status switches are read at this time and the unit is configured for baud rate, indicator type, and input signal type. The RD-300/RD-232 display goes through a power up sequence which provides valuable information about the operating condition and setup.

LAMP TEST-

The first display during power on clear is a lamp test. This test lights all display segments and decimal points.

If the display is too bright, adjust the multi-turn pots located on the RD-232 CPU board (see below). The RD-232

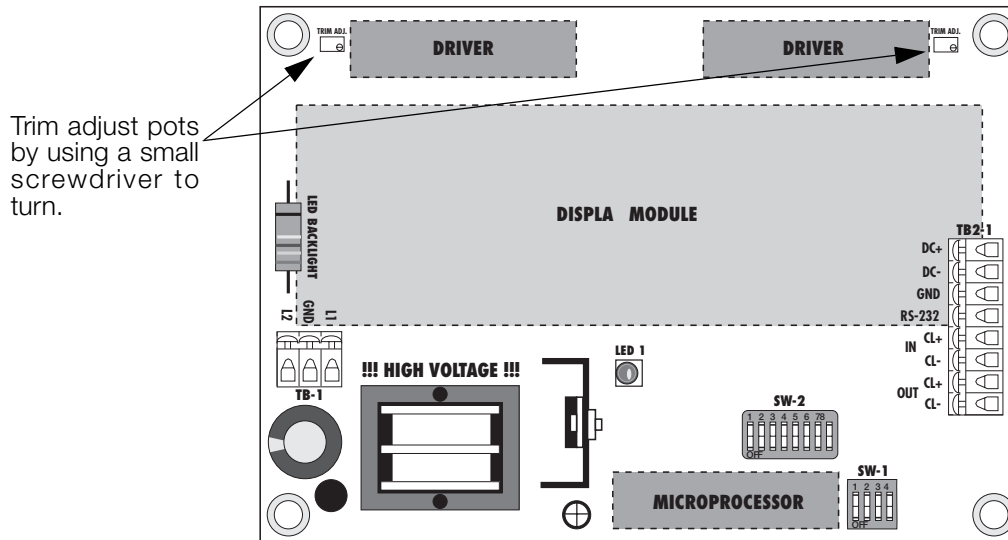

Figure 2-8. RD-232 Trim Adjusting Pot Location

remote display has two, 20K - 10 turn pots to adjust the intensity of the LED displays. The pots are located on the backside or component side of the display board located to the top outside of the circuit board. The pot to the right side adjusts the intensity of the three displays on the right side of the display board. The pot on the left side adjusts the intensity of the three displays on the left side of the display board.

Note: If the display intensity is adjusted to high, it will cause the micro's voltage and current to drop causing the remote to continually cycle it's power-up sequence. To correct this, turn the pots counter clockwise about half the adjustment or five turns. Repeat this adjustment on both pots to balance the display intensity.

PRODUCT SOFTWARE ID-

The unit should show *rd 300*.

SOFTWARE REVISION NUMBER-

Next the software revision number, *rev 2.1* is displayed.

CURRENT BAUD RATE SETTING-

The RD-300/RD-232 next shows the current baud rate setting it has read from switch SW1. The display will show *baud 3*, for 300 baud, *baud 6*, for 600 baud, *baud12*, for 1200 baud, *baud24*, for 2400 baud, *baud48*, for 4800 baud, or *baud96*, for 9600 baud, *baud19*, for 19,200 baud, or *baud38*, for 38,400 baud.

INDICATOR TYPE-

The RD-300/RD-232 will show the indicator type you have chosen through SW1. This is displayed as *Ind 0* through *Ind 15*.

INDICATOR INTERFACE TYPE -

The RD-300/RD-232 shows either, *C loop* or *rs 232*.

DISPLAY ON LOSS OF SIGNAL -

The RD-300/RD-232 shows either, *no sig* for no signal, or *las da* for the last valid data received.

RETRANSMIT DATA TYPE -

The RD-300/RD-232 next shows the data format of the retransmission. *rE-rec* means the data is transmitted as it was received. *rE-Con* means that the data will be converted and retransmitted in Consolidated Controls continuous data format.

TIME OUT ENABLE -

The RD-300/RD-232 will show, *cn ena* if the time out counter is enabled, and *cn dis* if the time out counter is disabled.

RECEIVING THE DATA FOR THE FIRST TIME-

After the power up sequence, the RD-300/RD-232 synchronizes with the incoming serial data line and looks for data to receive. If no readable data is received within a few seconds, the display shows *nosig*.

When communication is established, the current weight value is displayed. Decimal points are inserted into the display as indicated by the meter. If the data format from the meter makes LB, kg, Gross or Net status available, the RD-300/RD-232 displays this information with the appropriate status segments. Some formats do not make this data available. In this case, the segments are not illuminated.

If you have trouble, remember, you must have continuous data coming from the meter. The most common problems are non-standard indicator serial outputs, mis-wiring, and mis-programming both in the meter and in the RD-300/RD-232 setup. Check the LED and see if it is flashing. If it is, then something is being received.

NOTE: *This doesn't mean that the format is correct, only that data is appearing at the receiver.*

When the display is operating properly, the job is only partially done. Any good installation isn't finished until the enclosure mounting is checked and tightened, all conduit and cable entries are wrench tight, and the enclosure screws have been tightened with a socket or screwdriver.

If the RD-300/RD-232 is located in a wet, damp, or cold environment, it is suggested to use a silica gel desiccant or better yet, an antioxidant "snowball" made by Hoffman Enclosure Company. These products in the enclosure will greatly increase product reliability and performance. Change any desiccant at least two times per year.

3.0 Mounting Procedure for Panel Mount RD-300/232

Use the following procedure if panel mounting the RD-300/232. A template for measuring is shown on page 17.

1. Choose a desired location for mounting the RD-300/232. Make sure there are no AC wires or other obstructions behind the area to be cut out.
2. Use the enclosed template to mark the panel holes. Note that all holes are measured center to center.
3. Transfer the holes onto the desired panel. Start from one side and make all other measurements starting from that side. Using this method reduces errors. Try to mark the center of the holes. Drill the four OUTER holes with a #.228 or 15/64" drill bit.
4. Drill the INNER four holes with a #.156 or 5/32" drill bit.
5. When the holes have been drilled and checked for accuracy, cut the hole for the display as shown on the template. Make the edges as smooth as possible because the front plate must lay flush on top of it.
6. Detach the circuit board from the front plate and remove the nut and lockwashers from the mounting screws. Place the front plate on the panel from the front and push the mounting screws and studs through the holes as shown in Figure 3-1.

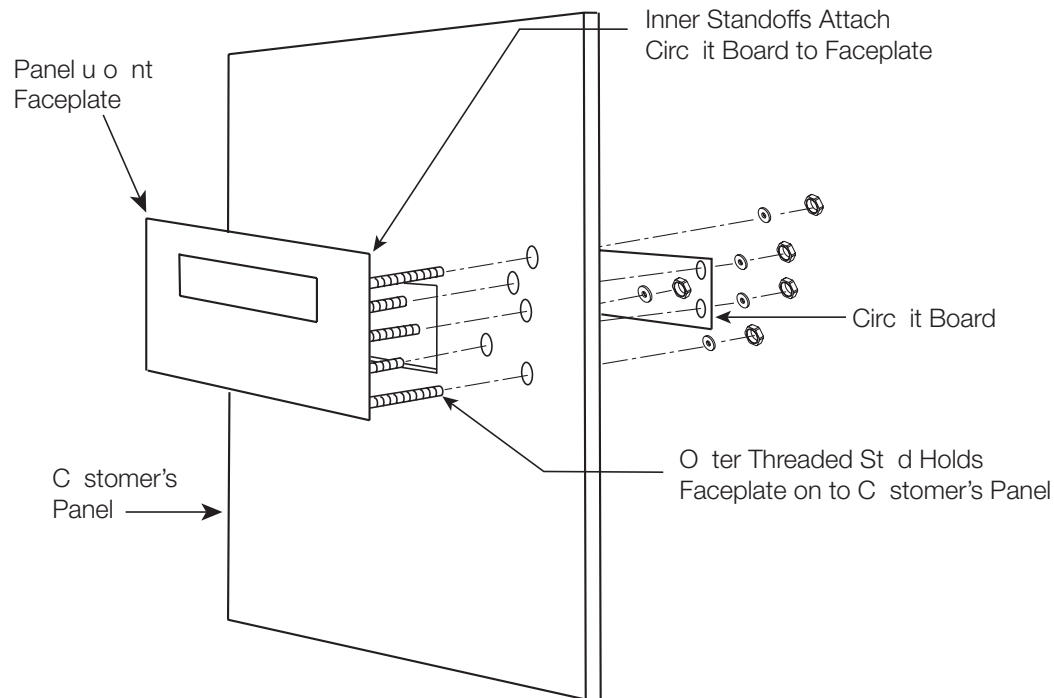
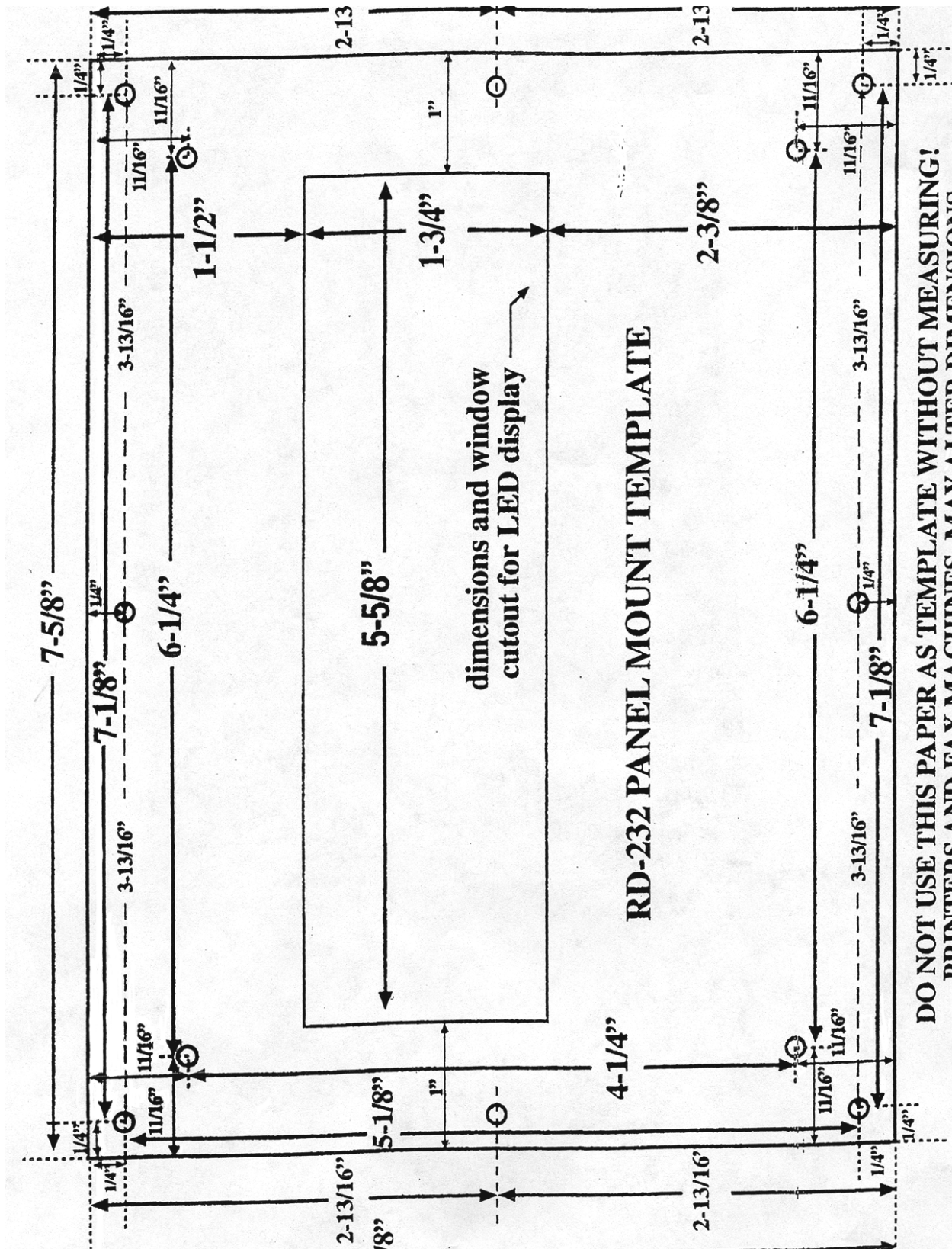

Figure 3-1. Mounting Procedure for Panel Mount

Have someone hold it or secure it with removable tape while putting the lockwashers and nuts back on the mounting screws and tighten.

Note: you will find that the mounting studs 8-32 x 3/4", have nuts and lockwashers included. If you lose one, they can be replaced at most local hardware stores.

7. Check from the front to make sure the edges of the cutout do not show through the window and that the front plate is lying flat against your panel. Remount the circuit board with the original screw and plastic washers.
8. Proceed with wiring instructions per manual instructions.



RD-232 PANEL MOUNT TEMPLATE

**DO NOT USE THIS PAPER AS TEMPLATE WITHOUT MEASURING!
PRINTERS AND FAX MACHINES MAY ALTER DIMENSIONS.**

4.0 Appendix

4.1 RD-300 Replacement Parts

The following table list the replacement parts for the RD-300 remote display.

Part Number	Description	Quantity
32724	Board, display/CPU RD-300 R2N 1" LCD serial	1
32725	Board, display/CPU RD-300 R2B 1" LCD w/ backlight serial	1
32723	Microprocessor, RD-300/MPU revision 2.1	1
16348	IC, 20 mA receiver HP-4200	1
22586	Display driver MC145453	2
22588	Fuse, .25A slo-blo PCB	2
22546	Overlay, front panel, RD-300	1

Table 4-1. RD-300 Replacement Parts List

4.2 RD-232 Replacement Parts

The following table list the replacement parts for the RD-232.

Part Number	Description	Quantity
32726	Board, display/CPU RD-232 R2N 0.8" LED serial	1
32723	Microprocessor, RD-232/MPU revision 2.1	1
16348	IC, 20 mA receiver HP-4200	1
16234	Display driver MC145453	2
22588	Fuse, .25A slo-blo PCB	2

Table 4-2. RD-232 Replacement Parts List

RD-300/RD-232 Limited Warranty

Rice Lake Weighing Systems (RLWS) warrants that all RLWS equipment and systems properly installed by a Distributor or Original Equipment Manufacturer (OEM) will operate per written specifications as confirmed by the Distributor/OEM and accepted by RLWS. All systems and components are warranted against defects in materials and workmanship for one year.

RLWS warrants that the equipment sold hereunder will conform to the current written specifications authorized by RLWS. RLWS warrants the equipment against faulty workmanship and defective materials. If any equipment fails to conform to these warranties, RLWS will, at its option, repair or replace such goods returned within the warranty period subject to the following conditions:

- Upon discovery by Buyer of such nonconformity, RLWS will be given prompt written notice with a detailed explanation of the alleged deficiencies.
- Individual electronic components returned to RLWS for warranty purposes must be packaged to prevent electrostatic discharge (ESD) damage in shipment. Packaging requirements are listed in a publication, *Protecting Your Components From Static Damage in Shipment*, available from RLWS Equipment Return Department.
- Examination of such equipment by RLWS confirms that the nonconformity actually exists, and was not caused by accident, misuse, neglect, alteration, improper installation, improper repair or improper testing; RLWS shall be the sole judge of all alleged non-conformities.
- Such equipment has not been modified, altered, or changed by any person other than RLWS or its duly authorized repair agents.
- RLWS will have a reasonable time to repair or replace the defective equipment. Buyer is responsible for shipping charges both ways.
- In no event will RLWS be responsible for travel time or on-location repairs, including assembly or disassembly of equipment, nor will RLWS be liable for the cost of any repairs made by others.

THESE WARRANTIES EXCLUDE ALL OTHER WARRANTIES, EXPRESSED OR IMPLIED, INCLUDING WITHOUT LIMITATION WARRANTIES OF MERCHANTABILITY OR FITNESS FOR A PARTICULAR PURPOSE. NEITHER RLWS NOR DISTRIBUTOR WILL, IN ANY EVENT, BE LIABLE FOR INCIDENTAL OR CONSEQUENTIAL DAMAGES.

RLWS AND BUYER AGREE THAT RLWS'S SOLE AND EXCLUSIVE LIABILITY HEREUNDER IS LIMITED TO REPAIR OR REPLACEMENT OF SUCH GOODS. IN ACCEPTING THIS WARRANTY, THE BUYER WAIVES ANY AND ALL OTHER CLAIMS TO WARRANTY.

SHOULD THE SELLER BE OTHER THAN RLWS, THE BUYER AGREES TO LOOK ONLY TO THE SELLER FOR WARRANTY CLAIMS.

NO TERMS, CONDITIONS, UNDERSTANDING, OR AGREEMENTS PURPORTING TO MODIFY THE TERMS OF THIS WARRANTY SHALL HAVE ANY LEGAL EFFECT UNLESS MADE IN WRITING AND SIGNED BY A CORPORATE OFFICER OF RLWS AND THE BUYER.

© 2005 Rice Lake Weighing Systems, Inc. Rice Lake, WI USA. All Rights Reserved.

RICE LAKE WEIGHING SYSTEMS • 230 WEST COLEMAN STREET • RICE LAKE, WISCONSIN 54868 • USA