

CW-90/90X

Checkweigher
Firmware Version 1.10

Technical Manual



An ISO 9001 registered company
© Rice Lake Weighing Systems. All rights reserved.

Rice Lake Weighing Systems® is a registered trademark of
Rice Lake Weighing Systems.

All other brand or product names within this publication are trademarks or
registered trademarks of their respective companies.

All information contained within this publication is, to the best of our knowledge, complete and
accurate at the time of publication. Rice Lake Weighing Systems reserves the right to make
changes to the technology, features, specifications and design of the equipment without notice.

The most current version of this publication, software, firmware and all other product
updates can be found on our website:

www.ricelake.com

Contents

1.0	Introduction	1
1.1	Safety	1
1.2	FCC Compliance	2
1.3	Overview	2
1.4	Operating Modes	2
1.5	WLAN Option Card	2
1.6	Front Panel	3
1.7	Bar Graph LEDs	4
1.8	Tare Recall	4
2.0	Installation	5
2.1	Unpacking and Assembly	5
2.2	Leveling	6
2.3	Making Power Connections	6
2.4	Enclosure Disassembly	6
2.5	Load Cell Wiring	6
2.6	Cable Grounding	7
2.6.1	Stripping Cables	7
2.6.2	Serial Communications	8
2.6.3	Digital I/O	8
2.7	Enclosure Reassembly	9
2.8	Board Removal	9
2.9	Battery Replacement	9
2.10	Installing Option Cards	10
2.11	Sealing	11
2.11.1	Sealing Methods	11
2.12	Dimensions	13
2.13	Replacement Parts	14
3.0	Configuration	16
3.1	Menu Navigation	16
3.1.1	Alpha/Numeric Entry	16
3.2	AUDIT Menu	17
3.3	CALIBR Menu	18
3.4	SETUP Menu	19
3.4.1	SCALE Menu	20
3.4.2	FEATUR Menu	26
3.4.3	SERIAL Menu	35
3.4.4	PFORMT Menu	37
3.4.5	DIGIO Menu	38
3.4.6	DIO Menu	39
3.4.7	VERS Menu	40
3.5	Test Menu	41
3.5.1	A/D Menu	42
3.5.2	DIG I/O Menu	42
3.5.3	COMM Menu	43
3.6	Time and Date Menu	43
3.7	ACCUM Menu	43
3.8	BRIGHT Menu	44



Technical training seminars are available through Rice Lake Weighing Systems. Course descriptions and dates can be viewed at www.ricelake.com/training or obtained by calling 715-234-9171 and asking for the training department.

Contents

3.9	ID Menu	44
4.0	Calibration	45
4.1	Front Panel Calibration	46
4.1.1	Five-Point Linearization	47
4.1.2	Rezero	48
4.2	EDP Command Calibration	48
4.3	Revolution Calibration	49
4.3.1	More About Calibration	49
5.0	Operation	50
5.1	Range Mode	50
5.1.1	Value Set: Keyed	51
5.1.2	Value Set: Push	51
5.2	Target Weight Mode	51
5.2.1	Value Set: Keyed	52
5.2.2	Value Set: Push	52
5.3	Target Percent Mode	53
5.3.1	Value Set: Keyed	53
5.3.2	Value Set: Push	54
5.4	IDs	55
5.4.1	Setting an ID	55
5.4.2	Using a Stored ID	57
5.4.3	WeighVault	58
5.5	Negative Checkweighing	59
6.0	Serial Commands	61
6.1	The Serial Command Set	61
6.1.1	Key Press Commands	61
6.1.2	ID Commands	62
6.1.3	Reporting Commands	62
6.1.4	Clear and Reset Commands	62
6.1.5	Parameter Setting Commands	63
6.1.6	Normal Mode Commands	66
6.1.7	Unique Commands	66
6.2	Custom Stream Formatting	67
7.0	Print Formatting	69
7.1	Print Formatting Commands	69
7.2	Customizing Print Formats	70
7.2.1	Using the EDP Port	70
7.2.2	Using the Front Panel	71
7.2.3	Using Revolution	71
8.0	Appendix	72
8.1	Error Messages	72
8.2	Using the XE EDP Command	73
8.3	Status Messages	74
8.3.1	Using the P EDP Command	74
8.3.2	Using the ZZ EDP Command	74



Rice Lake continually offers web-based video training on a growing selection of product-related topics at no cost. Visit www.ricelake.com/webinars

Contents

8.4	Continuous Output (Stream) Format	74
8.5	Digital Filtering	75
8.5.1	DIGFLx Parameters	75
8.5.2	DFSENS and DFTHRH Parameters	75
8.5.3	Setting the Digital Filter Parameters	76
8.5.4	Audit Trail Support	76
8.6	Regulatory Mode Functions	77
8.7	Updating CW-90/90X Firmware	78
9.0	CW-90/90X Limited Warranty	80
10.0	Compliance	81
11.0	Specifications	82



Technical training seminars are available through Rice Lake Weighing Systems. Course descriptions and dates can be viewed at www.ricelake.com/training or obtained by calling 715-234-9171 and asking for the training department.



Rice Lake continually offers web-based video training on a growing selection of product-related topics at no cost. Visit www.ricelake.com/webinars

1.0 Introduction

This manual is intended for use by qualified service technicians responsible for installing and servicing the CW-90/90X checkweighing scale.



Manuals and additional resources are available from Rice Lake Weighing Systems at www.ricelake.com/manuals

Warranty information can be found on the website at www.ricelake.com/warranties

1.1 Safety

Safety Signal Definitions:



DANGER Indicates an imminently hazardous situation that, if not avoided, will result in death or serious injury. Includes hazards that are exposed when guards are removed.



WARNING Indicates a potentially hazardous situation that, if not avoided, could result in serious injury or death. Includes hazards that are exposed when guards are removed.



CAUTION Indicates a potentially hazardous situation that, if not avoided, could result in minor or moderate injury.



IMPORTANT Indicates information about procedures that, if not observed, could result in damage to equipment or corruption to and loss of data.

General Safety



Do not operate or work on this equipment unless this manual has been read and all instructions are understood. Failure to follow the instructions or heed the warnings could result in injury or death. Contact any Rice Lake Weighing Systems dealer for replacement manuals.



Failure to heed could result in serious injury or death.

Some procedures described in this manual require work inside the indicator enclosure. These procedures are to be performed by qualified service personnel only.

Do not allow minors (children) or inexperienced persons to operate this unit.

Do not operate without all shields and guards in place.

Do not step on the unit.

Do not jump on the scale.

Do not use for purposes other than weight taking.

Do not place fingers into slots or possible pinch points.

Do not use any load bearing component that is worn beyond 5% of the original dimension.

Do not use this product if any of the components are cracked.

Do not exceed the rated load limit of the unit.

Do not make alterations or modifications to the unit.

Do not remove or obscure warning labels.

Before opening the unit, ensure the power cord is disconnected from the outlet.

Keep hands, feet and loose clothing away from moving parts.

1.2 FCC Compliance

United States

This equipment has been tested and found to comply with the limits for a Class A digital device, pursuant to Part 15 of the FCC Rules. These limits are designed to provide reasonable protection against harmful interference when the equipment is operated in a commercial environment. This equipment generates, uses, and can radiate radio frequency energy and, if not installed and used in accordance with the instruction manual, may cause harmful interference to radio communications. Operation of this equipment in a residential area is likely to cause harmful interference in which case the user will be required to correct the interference at his own expense.

Canada

This digital apparatus does not exceed the Class A limits for radio noise emissions from digital apparatus set out in the Radio Interference Regulations of the Canadian Department of Communications.

Le présent appareil numérique n'émet pas de bruits radioélectriques dépassant les limites applicables aux appareils numériques de la Class A prescrites dans le Règlement sur le brouillage radioélectrique édicté par le ministère des Communications du Canada.

1.3 Overview

The CW-90/90X is a high-speed digital weight indicator and scale base programmed to compare weight readings with predetermined tolerance limits defining an **ACCEPT** band.

If the current weight reading is within the acceptable range, the green **ACCEPT** LED is illuminated. If the current weight reading is less than the acceptable range, one or more of the red **UNDER** segments is illuminated. If the current weight reading is greater than the acceptable range, one or more of the yellow **OVER** segments is illuminated.

Features include:

- Large 8" LED display with UNDER, ACCEPT, and OVER bands
- Full numeric keypad (CW-90 only)
- Four configurable digital inputs/outputs
- Two independent communication ports, a full duplex and an unidirectional active 20 mA current loop

1.4 Operating Modes

The CW-90/90X has two modes of operation:

Weigh Mode

Weigh mode is the production mode of the indicator. The indicator displays the gross or net weight, depending on whether a tare has been entered. LED annunciators indicate the type of weight value.

Menu Mode

Most procedures described in this manual, including configuration and calibration, require the indicator to be in menu mode.

To enter the menu, see the following procedure:

- With the Audit jumper in the **ON** position, press , **AUDIT** displays
- With the Audit jumper in the **OFF** position, remove the large fillister head screw from the bottom of the enclosure; Insert a small non-conductive tool into the access hole to press the setup switch to enter **Menu** mode

1.5 WLAN Option Card

The optional Lantronix® xPico wireless networking device (PN 206272) can be installed inside the CW-90/90X Checkweigher. Refer to the WLAN Installation Addendum (PN 206460) included with the WLAN option card for installation and configuration.

1.6 Front Panel

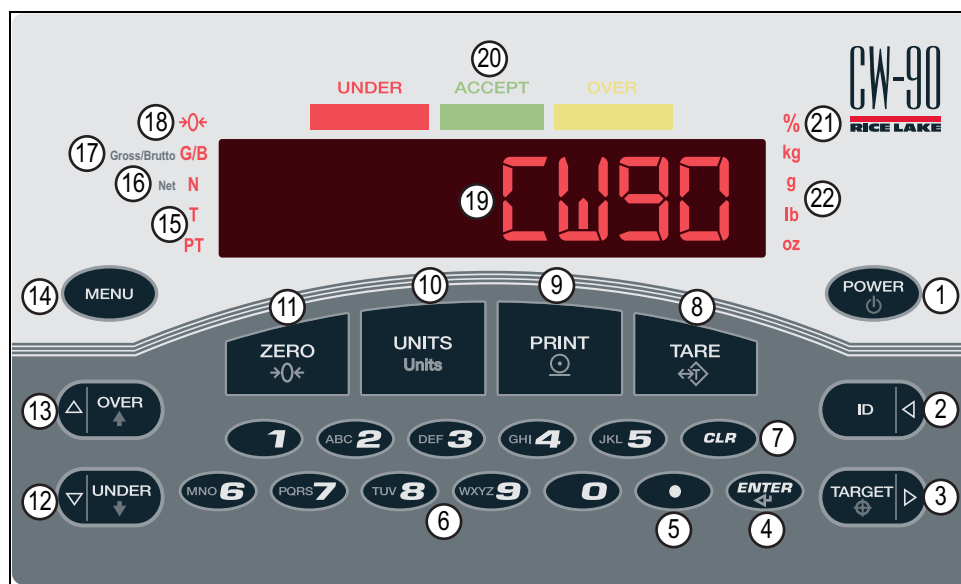

Figure 1-1. Front Panel (CW-90 Shown)

Function Keys

Item No.	Key	Function
1		Turns the unit on/off only if the jumper is set to SW; if jumper is off, the power cord is used to turn the unit on/off
2		Selects a particular over/under/tare/units register set to be retrieved and used
3		Used to acquire a weight value and assign it as the desired target value
4		Accept entries and move down in Menu mode
6	Keypad	Enter values directly (CW-90 only)
7		Backspace on entries (CW-90 only)
8		Performs predetermined Tare functions depending on the mode of operation selected in the TAREFN parameter (Section 3.4.1 on page 20); View a stored tare (Section 1.8 on page 4)
9		Sends on-demand serial information out the serial port, provided the conditions for standstill are met; PRINT displays during prints
10		Switches the weight display to an alternate unit, defined in the Setup menu; conversions of the weight reading, the Tare value, the Over and Under values occur when the unit of measure is changed NOTE: When working in lb/oz, any entered values need to be entered in ounces. This applies when entering over, under, target, and tare values.
11		Sets current gross weight to zero, provided the amount of weight to be removed or added is within the specified zero range and the scale is not in motion; the zero band is defaulted to 1.9% of full scale, but can be configured for up to 100% of full scale; 1.9% is required for Legal-for-Trade applications
12		Displays the current under tolerance value, or allows setting the current under tolerance value
13		Displays the current over tolerance value, or allows setting the over tolerance value
14		Enters the Menu mode, allowing configuration if the Audit jumper is in the ON position; Used as a back button in Menu mode

Table 1-1. Keypad Functions

LED Annunciators

Item No.	LED	Function
15	Tare	Indicates a tare has been acquired and stored
	Preset Tare	Indicates a preset tare weight has been keyed in or entered via the EDP serial port
16	Net	Indicates weight is displayed in Net mode (gross weight minus a tare weight)
17	Gross	Indicates weight is displayed in Gross mode (or Brutto in OIML mode)
18	Center of Zero	While in Gross mode, indicates the current displayed weight reading is within ± 0.25 display divisions of the acquired zero, or is within the center of zero band; In Net mode, it indicates the current net weight reading is within ± 0.25 display divisions of the center of net zero NOTE: A display division is the resolution of the displayed weight value, or the smallest incremental increase or decrease that can be displayed or printed.
19	Display	Weight display area
20	Bar Chart	See Section 1.7 on page 4
21	Percent	Value is displayed as percent
22	Unit	Weight unit being displayed; kg, g, lb, oz

Table 1-2. Keypad Functions

1.7 Bar Graph LEDs

The bar graph LEDs provide a quick way of determining if a container is too heavy (**OVER**), too light (**UNDER**) or within an acceptable weight range (**ACCEPT**).

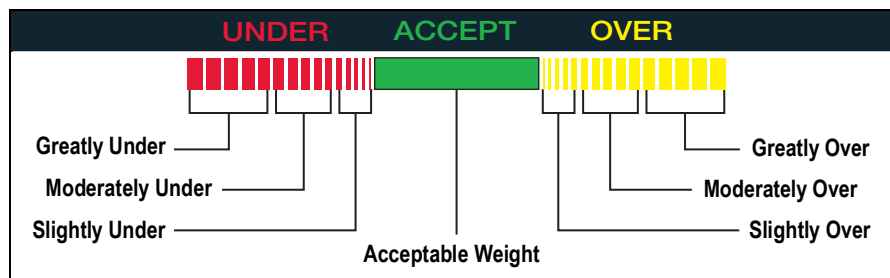

Figure 1-2. Bar Graph LEDs

The **UNDER** and **OVER** lights can be enabled to act as a graph or to appear as one solid bar. They can also be disabled so there are no lights. This is done using the **Feature** menu in [Section 3.4.2 on page 26](#).

Red Segments

Indicates the container weighs less than the lowest acceptable value. Left most red segments indicate the container weight is far below the acceptable weight band (greatly under); right most segments indicate the container weight is almost in the acceptable weight band (slightly under). Illuminating the center segments indicates middle-ground, or moderately under.

Green Segment

Indicates an acceptable value and the container weight is within the actual acceptable band of weight limits.



Yellow Segments

Indicates the container weighs more than the highest acceptable value. The right most yellow segments indicate the container weight is far above the acceptable weight band (greatly over); the leftmost segments indicate the container weight is almost in the acceptable weight band (slightly over). Illuminating the center segments indicates middle-ground, or moderately over.

1.8 Tare Recall

When a stored tare is displayed, the gross and net annunciators are turned off and the PT annunciator is lit.

To display a stored tare:

1. Press .
2. Press . The tare value is displayed for 10 seconds. If there is no tare in the system, nothing will display.

2.0 Installation

This section contains instructions on unpacking and assembly, leveling, making power connections, load cell wiring, wiring standard serial port, optional network communications, wiring optional digital outputs, procure of how to change the battery, board diagrams, and power-up sequence.

IMPORTANT

Do not pick up the scale by the spider assembly which supports the platter, it may damage the load cell.

Lift the scale from under the base to move it.

If the rear panel of the indicator is removed see [Section 2.7 on page 9](#) for installation procedure.

2.1 Unpacking and Assembly

The indicator head and support column or stand are shipped detached from the scale platform. Remove all components from the shipping carton.

IMPORTANT

The indicator head and scale platform are joined by the load cell cable. This cable is correctly wired to the load cell terminal in the indicator. Do not pull on the connections at either end of the cable.

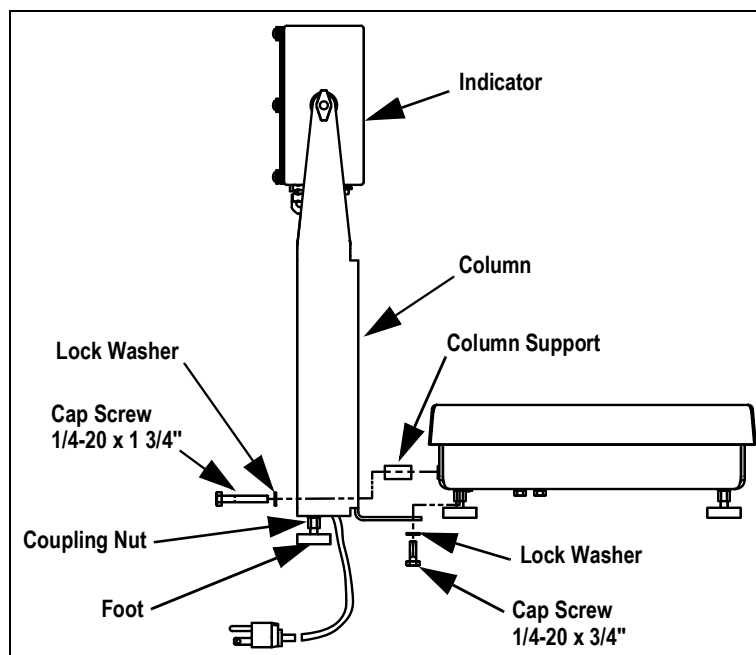

Figure 2-1. Mounting Column to Scale Platform

1. If mounting the head onto a column, remove the platter from the scale platform and set aside.
2. Invert the platform to access the column mounting holes on the rear and bottom of the platform.
3. Position the column over the four mounting holes.
4. Install two 1/4-20 x 3/4" cap screws with lock washers in mounting holes on bottom side of the platform.
5. Install two 1/4-20 x 1-3/4" cap screws, lock washers, and column supports in the holes on rear of platform.
6. Install coupling nuts, counter bored end first, onto threaded stem of rubber feet.
7. Install feet onto bottom side of the column.
8. Turn the CW-90/90X upright and replace the platter on the platform.
9. Attach indicator to the column with the two knobs and nylon washers provided. Position nylon washers between indicator enclosure and column mounting holes.

2.2 Leveling

Set the CW-90/90X in an area that is level and free of vibrations and air currents. Adjust the four corner feet on the base and refer to the bubble level on the inside frame. The base should not rock and the feet should have solid contact with the surface. If using a column, adjust the two column feet until they make solid contact with the support surface.



Note Ensure the nut on each foot's bolt is secured flush against the scale base.

2.3 Making Power Connections

The power source used for the CW-90/90X must be properly grounded to an acceptable earth ground. If the indicator is remotely mounted, the platform must be separately grounded from the chassis ground screw located on the bottom of the platform. Connect this screw with 18 gauge wire to the same earth ground system as the AC power source. Failure to ground the base may cause static buildup and incorrect weights.



WARNING Ensure the CW-90 is installed near an easily accessible power outlet to allow for quick disconnect in case of emergency.

2.4 Enclosure Disassembly

The indicator enclosure must be opened to connect cables for load cells, communications, and digital inputs/outputs.



WARNING Before opening the unit, ensure the power cord is disconnected from the power outlet.

1. Place the indicator face-down on an anti-static mat.
2. Remove the screws securing the backplate to the enclosure body.
3. Lift the backplate off the enclosure and set it aside.

2.5 Load Cell Wiring

On all complete units (indicator head and base), the load cell has been wired to the indicator's CPU load cell terminal at the factory. If just the indicator head has been purchased, the load cell will need to be wired.

Wire the cable to the CPU board's J1 connector as shown in [Table 2-1](#). Leave any excess cable outside of the indicator head during installation.



Note If using a 4-wire connection, set JP1 and JP2 to ON. If using a 6-wire connection, set JP1 and JP2 to OFF.

J1 Pin	Function
1	+ Signal
2	- Signal
3	+ Sense
4	- Sense
5	+ Excitation
6	- Excitation

Table 2-1. J1 Pin Assignments

Specifics

Wires connecting to J1, J2, J3, or J4 should adhere to the following specifications:

Wire Range	Wire Strip Length
28~12 AWG stranded or solid wire	3/16" ~ 1/4" (5~6 mm)

Table 2-2. Wire Specifications for Connectors

2.6 Cable Grounding

Except for the power cord, all cables routed through the cord grips should be grounded against the indicator enclosure.

1. Use the lockwashers, clamps, and keps nuts provided in the parts kit to install grounding clamps on the enclosure studs adjacent to cord grips. Install grounding clamps only for cord grips used; do not tighten nuts.
2. Route the cables through the cord grips and the grounding clamps to determine the cable lengths required to reach the cable connectors.
3. Mark the cables to remove insulation and shield ([Section 2.6.1](#)).
4. Finish installation using cable mounts and ties to secure cables inside of indicator enclosure.

2.6.1 Stripping Cables

Foil Insulated Cable

1. Strip the insulation and foil from the cable 1/2" (15 mm) past the grounding clamp.

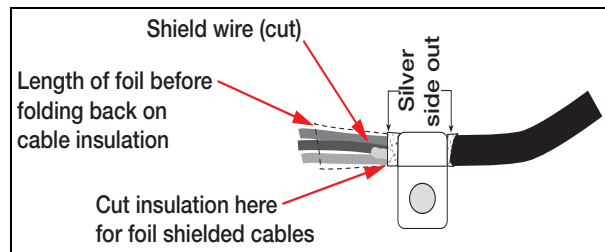

Figure 2-2. Foil Insulated Cable

2. Fold the foil shield back on the cable where the cable passes through the clamp.
3. Ensure the silver (conductive) side of the foil is turned outward for contact with the grounding clamp.

Braided Shielding

1. Strip the insulation and braided shield from a point just past the grounding clamp.

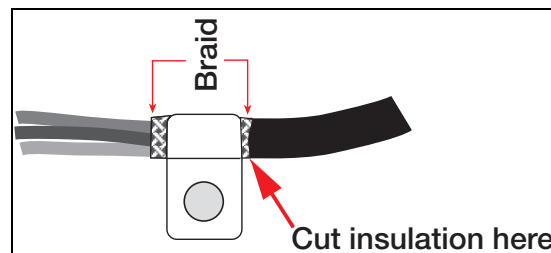

Figure 2-3. Braided Shielding

2. Strip another 1/2" (15 mm) of the insulation to expose the braid where the cable passes through the clamp.

Load Cell Cables

Cut the shield wire just past the grounding clamp. Shield wire function is provided by contact between the cable shield and the grounding clamp.

2.6.2 Serial Communications

Port 1 supports full duplex RS-232 communications only; Port 2 provides either active 20 mA output or duplex RS-232 transmission.

1. Wire serial communications cables to J2, which is Port 1 (5-wire RS-232 port) and J3, which is Port 2 (RS-232 and 20 mA).
2. Use cable ties to secure serial cables to the inside of the enclosure.
3. Configure both ports using the **SERIAL** menu (Section 3.4.3 on page 35).

Connector	Pin	Signal	Port	Connector	Pin	Signal	Port
J2	1	Ground	1	J3	1	20mA+	2
	2	Ground					
	3	Tx					
	4	Rx					
	5	DTR					
	6	RTS					

Table 2-3. J2 and J3 Pin Assignments

2.6.3 Digital I/O

The Digital I/O can be configured as either digital inputs or digital outputs as determined by the **DIO** menu (Section 3.4.6 on page 39). The inputs are active (on) with low voltage (0 VDC) and can be driven by TTL or 5V logic without additional hardware. Use the **DIG I/O** menu to configure the digital inputs. LEDs on the CPU board light when digital inputs are active.

Digital outputs are typically used to control relays that drive other equipment. Outputs are designed to sink not source, switching current. Each output is a CMOS circuit, capable of sinking 24 mA when active. Digital outputs are wired to switch relays when the digital output is active (low, 0 VDC) with reference to 5 VDC supply. LEDs on the CPU board light up when the digital outputs are active.

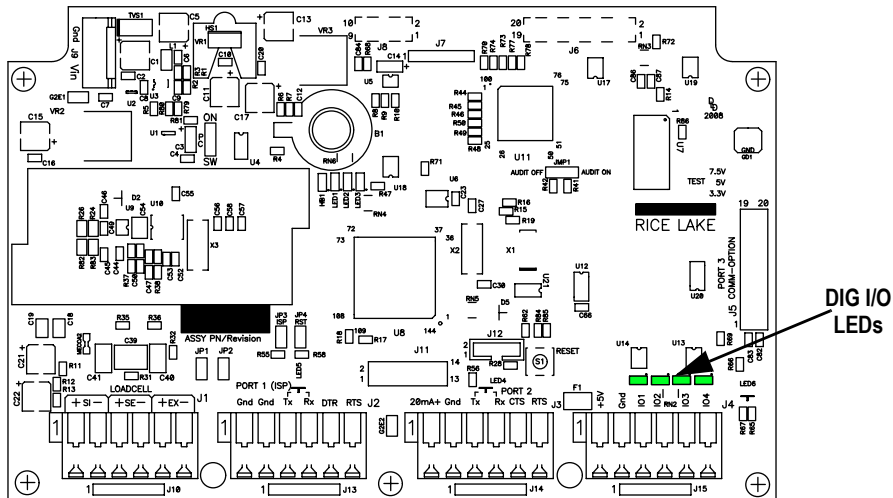

Figure 2-4. Digital I/O Lights and Screw Locations

Connector	Pin	Signal
J4	1	+5V
	2	Ground
	3	DIG I/O 1
	4	DIG I/O 2
	5	DIG I/O 3
	6	DIG I/O 4

Table 2-4. J4 Pin Assignments (Digital I/O)

2.7 Enclosure Reassembly

Once the cabling is complete align the backplate with gasket to the enclosure and secure with the screws. Use the torque pattern in [Figure 2-5](#) to prevent distortion. Torque to 15 in-lb (1.7 N-m).



Note

Torqued screws may become less tight as the gasket is compressed during torque pattern, therefore a second torque is required using the same pattern and torque value.

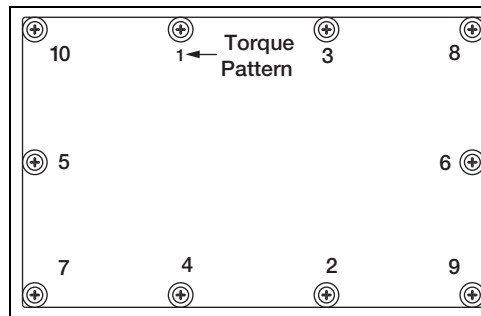

Figure 2-5. Tightening Sequence

2.8 Board Removal

To replace the CPU board, use the following procedure:

1. Disconnect power to the indicator. Remove backplate ([Section 2.4 on page 6](#)).
2. Disconnect power supply cable from connector J9.
3. Disconnect wires from connectors J1, J2, J3 and J4.
4. There are two boards: the CPU board and the keypad display board. Remove the five screws connecting the CPU board, then lift the board out of the enclosure.

To replace the CPU board, reverse the above procedure. Reinstall cable ties to secure all cables inside the indicator enclosure.

2.9 Battery Replacement



CAUTION

Risk of explosion if battery is replaced with incorrect type. Dispose of batteries per manufacturer instructions.

The lithium battery on the CPU board maintains the real-time clock and protects data stored in the system RAM when the indicator is not connected to AC power. Data protected by this battery includes time and date and IDs. Watch for low battery warning on the LCD display and periodically check battery voltage on CPU board. Batteries should be replaced when low battery warning indicator comes on or when battery voltage falls to 2.2 VDC. Life expectancy of the battery is 10 years. If any data is lost, the indicator configuration can be restored from the PC. Use Revolution to store a copy of the configuration before attempting to replace battery.

For best results, replace the battery while in **Weigh** mode and with AC power applied. Do not bend the battery retaining spring.

2.10 Installing Option Cards



Option cards are not hot-pluggable. Disconnect power cord entirely before installing option cards.



Ethernet port is not suitable for connection to circuits used outside the building. Option cards are subject to lightning/power faults.

Each option card is shipped with installation instructions specific to that card. The general procedure for all option cards is:

1. Disconnect power cord from the indicator.
2. Remove the backplate as described in [Section 2.4 on page 6](#).
3. Install the plastic standoffs in the standoff holes.
4. Carefully align the option card connector with the J5 connector on the CPU board.
5. Press down firmly to seat the option card in the CPU board connector.
6. Make connections to the option card as required. Use cable ties to secure loose cables inside the enclosure.
7. When installation is complete, reassemble the enclosure as described in [Section 2.7 on page 9](#).

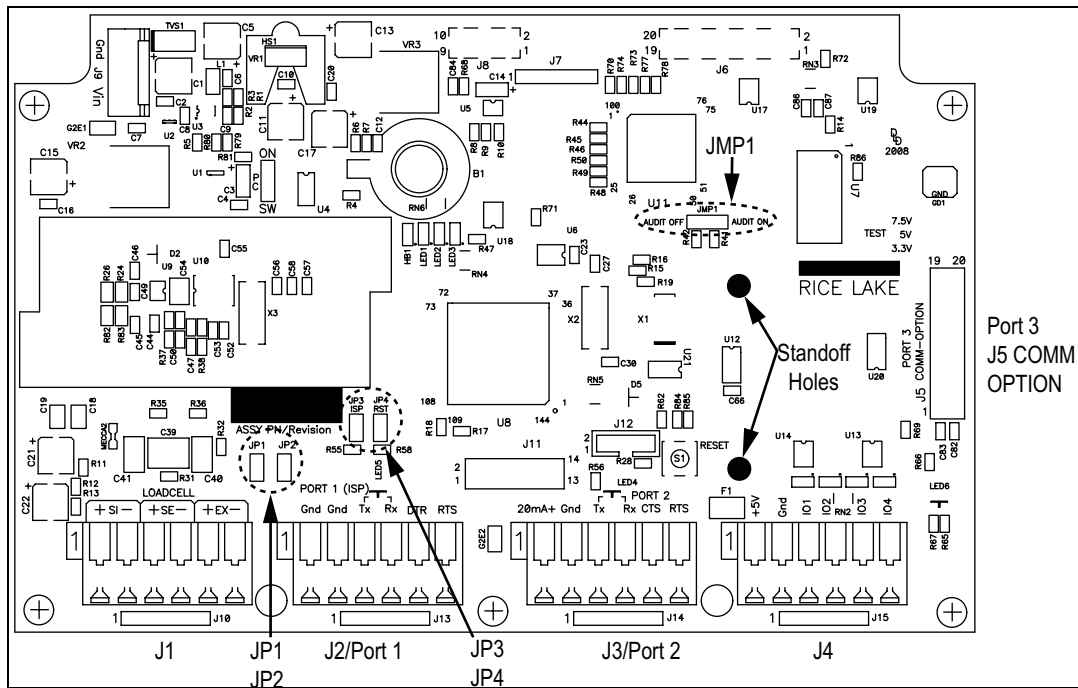

Figure 2-6. CW-90/90X CPU Board

Jumper	Description
JP1/JP2	Jump excitation to sense; If using a 4-wire load cell cable, leave JP1 and JP2 on; If using a 6-wire load cell cable, take JP1 and JP2 off; Default: ON
JP3/JP4	Used when upgrading firmware; The jumpers should be on when upgrading firmware and off when the update is complete
PC	Power control; If the jumper is set to SW, POWER key can be used to turn the unit on/off; If set to ON, the unit will power on when plugged in and can only be powered off by unplugging
JMP1	If set to Audit ON, calibration and configuration can be accessed through the front keypad; If set to Audit OFF, calibration and configuration can only be accessed by removing the screw on the underside of the enclosure and pressing the Setup switch with a screwdriver; Default Audit: ON

Table 2-5. Jumper Descriptions



Note If the **RESET** button on the CPU board is pressed, the indicator will perform a reboot.

2.11 Sealing

In certain Legal-for-Trade applications, it may be necessary to seal the unit to restrict access.

Use the following instructions to seal the unit:

2.11.1 Sealing Methods

To properly seal the unit, thread sealing wire through at least two contact points. Sealing method may vary depending on application use.

Two Contact Points

Seal the unit as shown below when using additional electronic sealing:



Figure 2-7. Two Point Sealing Method

Three Contact Points

Seal the unit as shown below if not using electronic sealing:

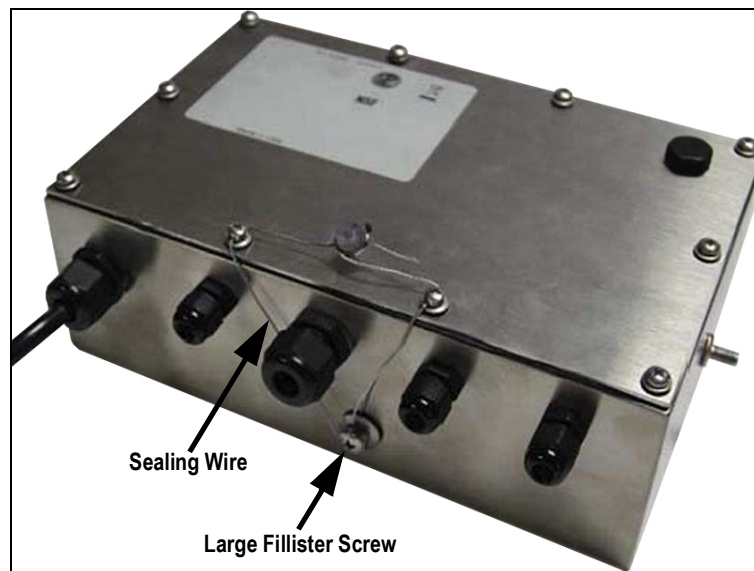

Figure 2-8. Three Point Sealing Method

Paper Sealing

Seal the unit using paper seals at the marked locations as shown below:

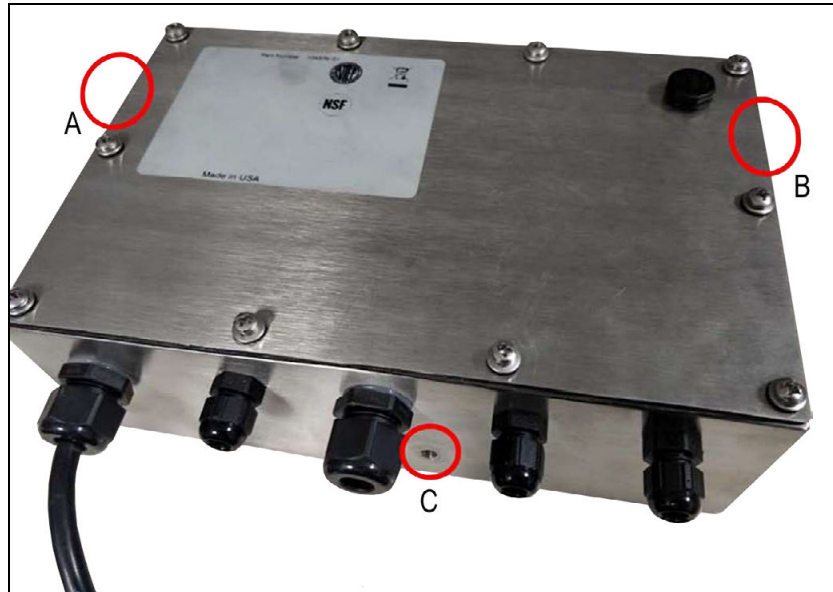

Figure 2-9. Paper Sealing Method



Note Sealing location C is not mandatory when using the audit trail as additional electronic sealing.

2.12 Dimensions

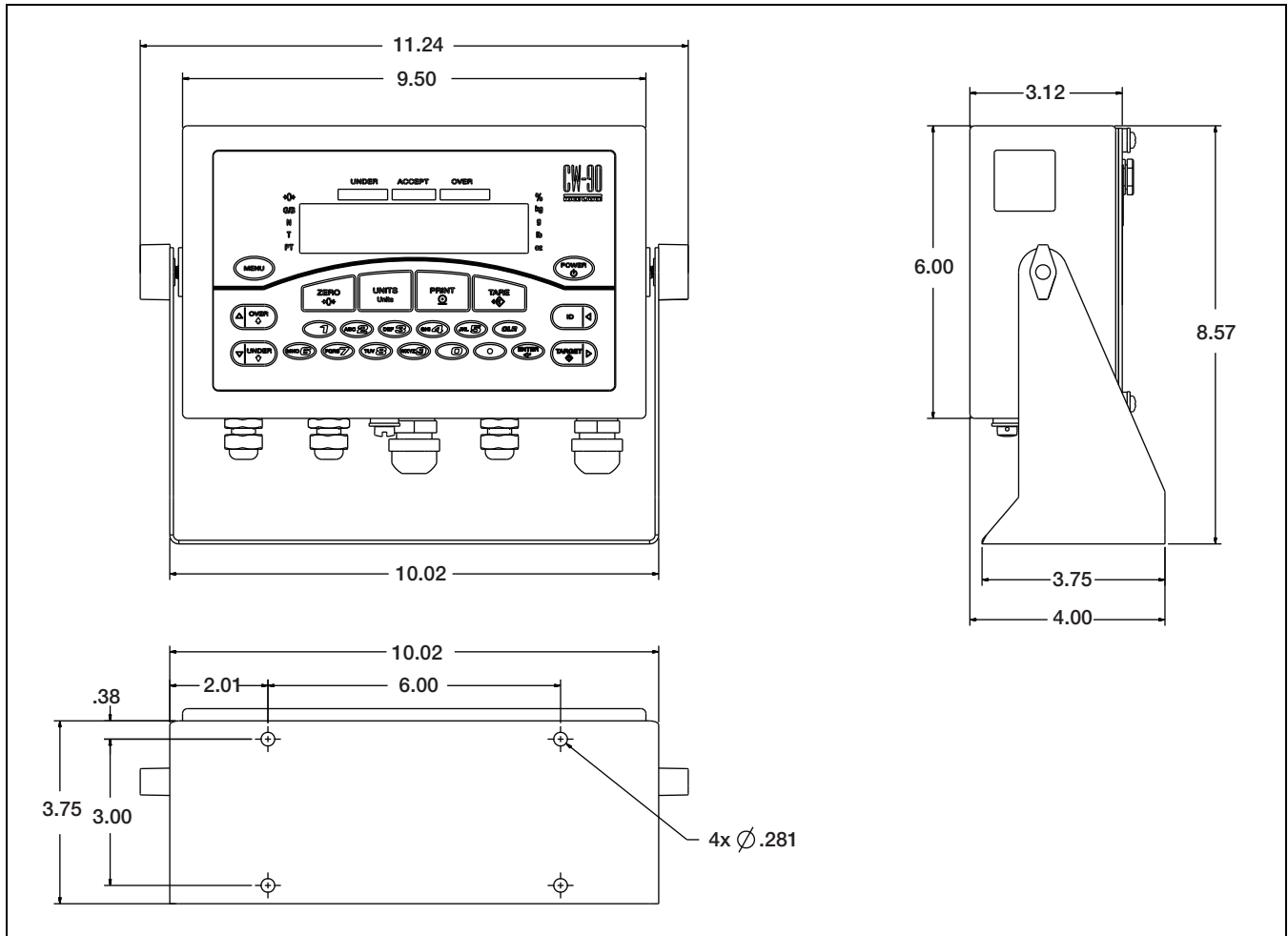

Figure 2-10. CW-90/90X Dimensions (inches)

2.13 Replacement Parts

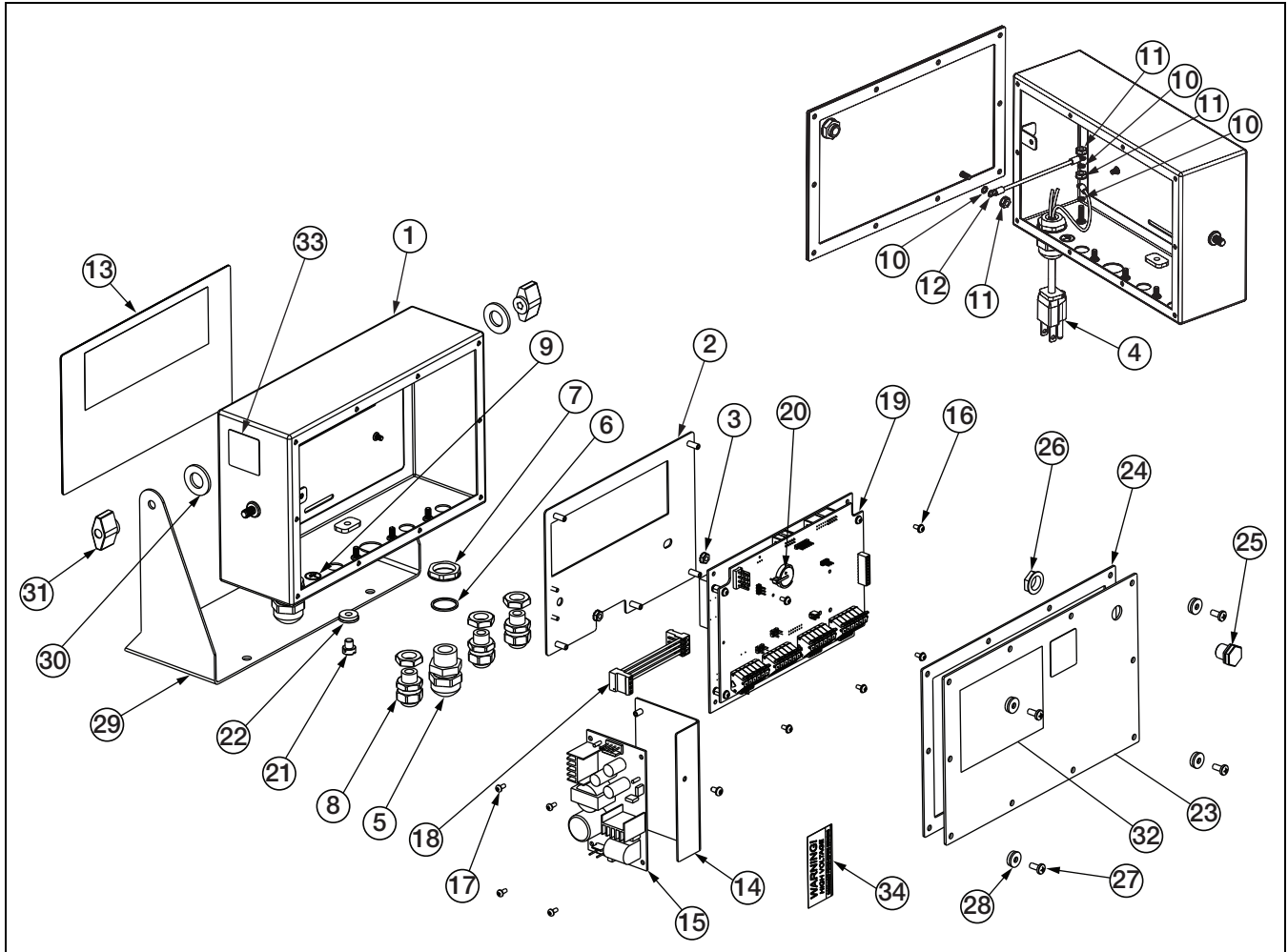

Figure 2-11. CW-90/90X Parts Illustration

Item No.	Part No.	Description	Qty
1	-	Enclosure	1
2	-	Mounting Plate, Display	1
3	14621	Nut, Kep 6-32NC HEX	2
4	85202	Power Cord Assembly, 120 VAC	1
	85203	Power Cord Assembly, 230 VAC	
5	68600	Cord Grip, PG11	1
6	68599	Seal Ring, Nylon PG11	1
7	68601	Nut, PG11	1
8	58983	Cable Grip, SL-7 with Nut	3
9	16892	Label, Earth Ground	1
10	15134	Washer, Lock NO 8 Type A	3
11	14626	Nut, Kep 8-32NC HEX	3
12	45043	Wire, Ground 4in W/No. 8	1
13	104914	Overlay, Membrane Switch (CW-90)	1
	104915	Overlay, Piezo (CW-90X)	
14	105850	Bracket, Power Supply	1
15	76556	Power Supply, Switching	1
16	14822	Screw, Mach 4-40NC x 1/4	6
17	14825	Screw, Mach 4-40NC x 1/4	4
18	105976	Cable Assembly, Power Supply	1

Item No.	Part No.	Description	Qty
19	102354	CPU	1
19	105741	Display	1
20	69291	Battery, 3 V Coin Lithium	1
21	42640	Screw, Mach 1/4-28NF X 1/4	1
22	44676	Washer, Bonded Sealing	1
23	-	Backplate	1
24	84388	Gasket, Backplate 420	1
25	88733	Vent, Breather Sealed	1
26	88734	Nut, Breather Vent	1
27	14862	Screw, MACH 8-32NC x 3/8	4
28	45042	Washer, Bonded Sealing SST	4
29	29635	Stand, Tilt SST	1
30	103988	Washer, Nylon .52 ID	2
31	103610	Knob, Black 1/4-20	2
32	53307	Label	1
33	53308	Label	1
34	16861	Label, Warning High	1
--	105945	Parts Kit, CW-90/90X	1
--	107476	Bench Scale Foot	4
--	105555	Coupling Nut for Feet and Overload Stops	4

Table 2-6. Replacement Parts

Scale Capacity	Part No.
5 lb	107174
10 lb	107174
25 lb	107175
50 lb	107176
100 lb	107177

Table 2-7. CW-90X Load Cells

Scale Capacity	Part No.
5 lb	107756
10 lb	107757
25 lb	107758
50 lb	107759
100 lb	107760

Table 2-8. CW-90 Load Cells

3.0 Configuration

This section guides the set up and configuration of the CW-90/90X checkweigher. The indicator is defaulted at the factory with the audit trail jumper (JMP1) in the ON position, allowing configuration access by pressing . If the CW-90/90X has been sealed for Legal-for-Trade, the setup switch needs to be pressed to gain access to the menus. The setup switch is located on the bottom of the indicator.

Pressing  displays the **Audit** menu selection.

3.1 Menu Navigation

The keys are used to navigate through the menus (Figure 3-1).

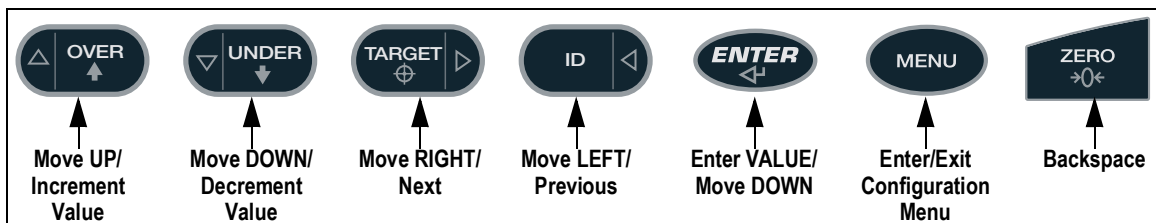









Figure 3-1. Front Panel Key Functions in Menu Mode



Note During calibration,  acts as a data entry confirmation key. It also acts as an EXECUTE key and accepts the value upon successful calibration. On the CW-90, the ZERO or CLR key can be used for a backspace.

3.1.1 Alpha/Numeric Entry

When adding or editing data:

- Press  or  to edit a flashing digit.
- Press  or  navigate to through digits.
- Press  to accept the data and return to the next menu item.
- Press  to exit configuration and return to weighing or navigate to the **EXIT** menu and press .



Note On the CW-90 the numeric keys can be used to insert a digit to the right of the blinking digit.

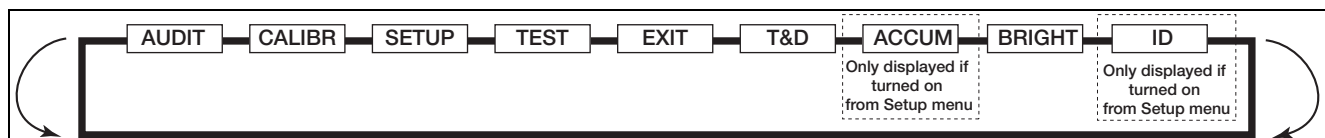

Figure 3-2. Menu Mode Navigation Structure

Menu	Function	Description
AUDIT	Audit Trail	Displays the legally relevant (LR) firmware version, configuration count, and calibration count
CALIBR	Calibrate	Calibrate the scale
SETUP	Setup	Access setup options: features, serial output, print format, digital inputs and outputs, and displays the version number
TEST	Test	Performs a basic test on the A/D, digital inputs and outputs, communication ports, RAM, and keypad
EXIT	Exit	Exits Configuration mode and returns to the weigh screen
T&D	Time & Date	View and change time and date
ACCUM	Accumulator	Displays the current accumulator value
BRIGHT	Brightness	Adjusts display intensity on a scale from 0 (dimmiest) to 7 (brightest)
ID	ID	Setup or edit IDs

Table 3-1. Menu Parameter List

3.2 AUDIT Menu

The **Audit** menu accesses audit trail support. It provides tracking information for configuration and calibration events. To prevent potential misuse, all configuration and calibration changes are counted as change events. Audit information can be printed by pressing **PRINT** while displaying the audit trail items beneath the **AUDIT** menu.

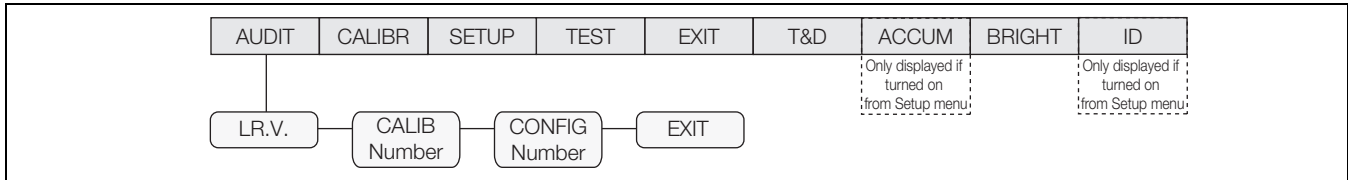

Figure 3-3. Audit Menu

Parameter	Description
LR.V.	Legally relevant firmware version
CALIB Number	Displays total calibration events; The display alternates between CALIB and the four-digit number
CONFIG Number	Displays total configuration events; The display alternates between CFG and the four-digit number
EXIT	Exits the audit trail and returns to Weigh mode

Table 3-2. Audit Menu Parameters

3.3 CALIBR Menu

See [Section 4.0 on page 45](#) for calibration procedures. The **Calibration** menu can be protected by assigning a password in the **Feature** menu.



Note The Calibration menu (CALIBR) is Read-Only when the Audit jumper is in the Off position.

When entering a floating point value, the decimal point will appear and flash on the far right (if it is not already on the screen).

To move the decimal, press , then use the < and > keys to move the decimal to the desired location.

The CW-90/90X requires the WZERO and WSPAN points to be calibrated. The linearity points are optional, but must NOT

duplicate zero or span. During calibration, acts as a data entry confirmation key. It also acts as an **EXECUTE** key, and accepts the value if calibration was successful.

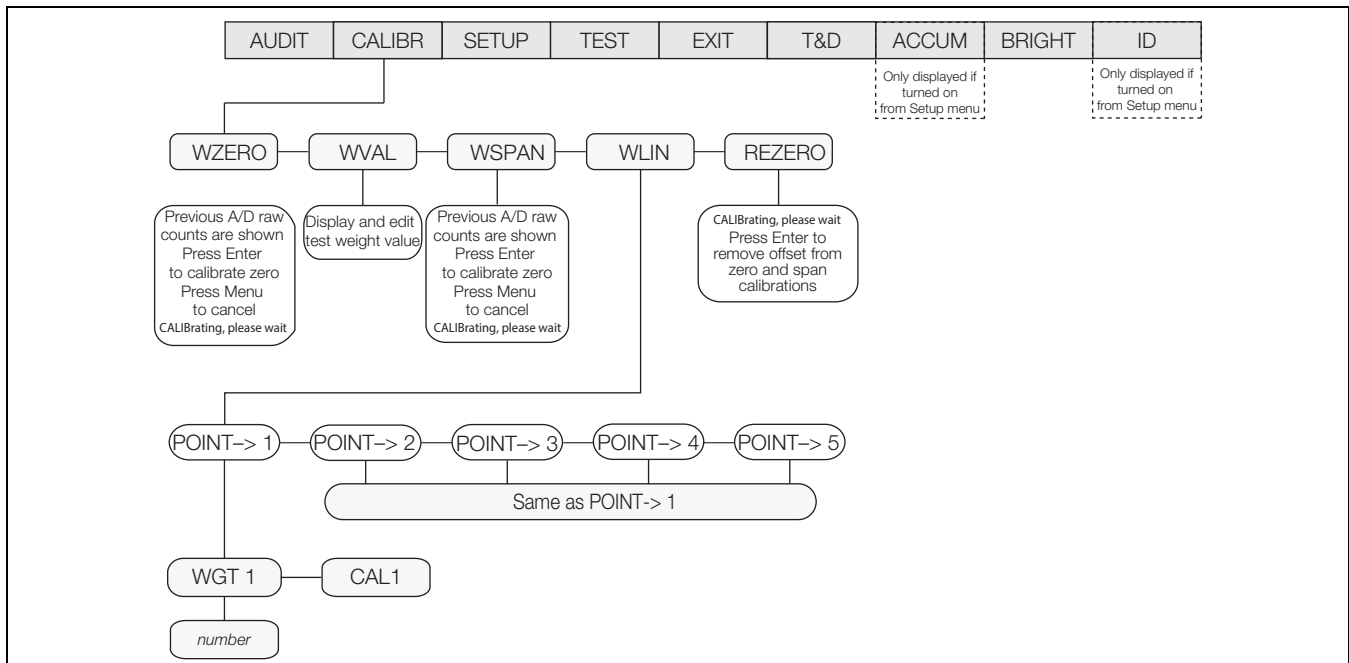

Figure 3-4. Calibration Menu

Parameter	Description
WZERO	Zero Weight; Press the ENTER key and the A/D raw counts displays; Press the ENTER key again to calibrate zero, or press the MENU key to cancel; CALIBRATING, PLEASE WAIT displays prior to automatically moving to WVVAL
WVVAL	Weight Value; Press the ENTER key to display and edit the test weight value; Press the ENTER key again to move to WSPAN
WSPAN	Weight Span; Press the ENTER key and the A/D raw counts displays; Press the ENTER key to calibrate the span or press the MENU key to cancel; CALIBRATING, PLEASE WAIT displays prior to automatically moving to WLIN
WLIN	Weight Linearization; WGT 1 allows you to display and edit the test weight value; Selections: PT->1 — PT->5; Press the ENTER key to edit the value; CAL1 allows you to calibrate and display the raw A/D value; Press the TARE key to perform calibration; Press the ENTER key to move to the next calibration point NOTE: The linearity points are optional, but must NOT duplicate zero or span. They must be between zero and span.
REZERO	Press the ENTER key to remove an offset value from the zero and span calibrations (e.g. if hooks or chains are used during calibration) NOTE: Use this parameter only after WZERO and WSPAN have been set. See Section 4.1 on page 46 for more information about using this parameter.

Table 3-3. Calibration Menu Parameters

3.4 SETUP Menu

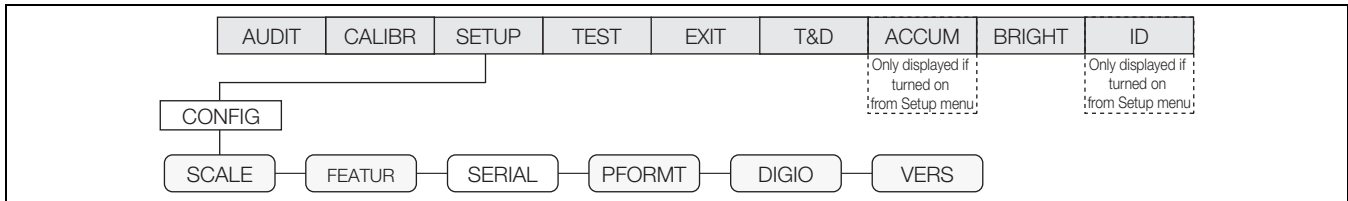

Figure 3-5. Setup Menu

Parameter	Choices	Description
SCALE	–	Configure scale settings; See Table 3-5 on page 21 for parameter descriptions
FEATUR	–	Set checkweighing options, region settings, view Unit ID, and set consecutive numbering; See Section 3.4.2 on page 26 for parameter descriptions
SERIAL	PORT 1 PORT 2 PORT 3 (Option Card)	Configure communications ports; See Section 3.4.3 on page 35 for parameter descriptions
PFORMT	GFMT NFMT ACCFMT STRM.FM BUF.FMT H1 H2	Sets the print format for gross weight, net weight, accumulated weight, stream, buffer, Header 1 and Header 2
DIG IO	DIO 1 DIO 2 DIO 3 DIO 4	Assign digital input/output functions
VERS	SOFTWR	Displays the software version
	REG	Displays the regulatory version
	DEFAULT	Restores settings to their default values

Table 3-4. Setup Menu Parameters

3.4.1 SCALE Menu

The **Setup** menu allows the scale to be configured as required for its intended use. Software and regulatory versions are displayed as read only. The indicator can also be reset to default.



Note If **RANGE** is displayed after a setup value is entered, the value is too large or small for the given parameter.

Calibration can be performed in two places within the menu: the **CALIBR** menu shown in Figure 3-6 is an in-depth scale setup and calibration. A quick access calibration is shown in Figure 4.1 on page 46.

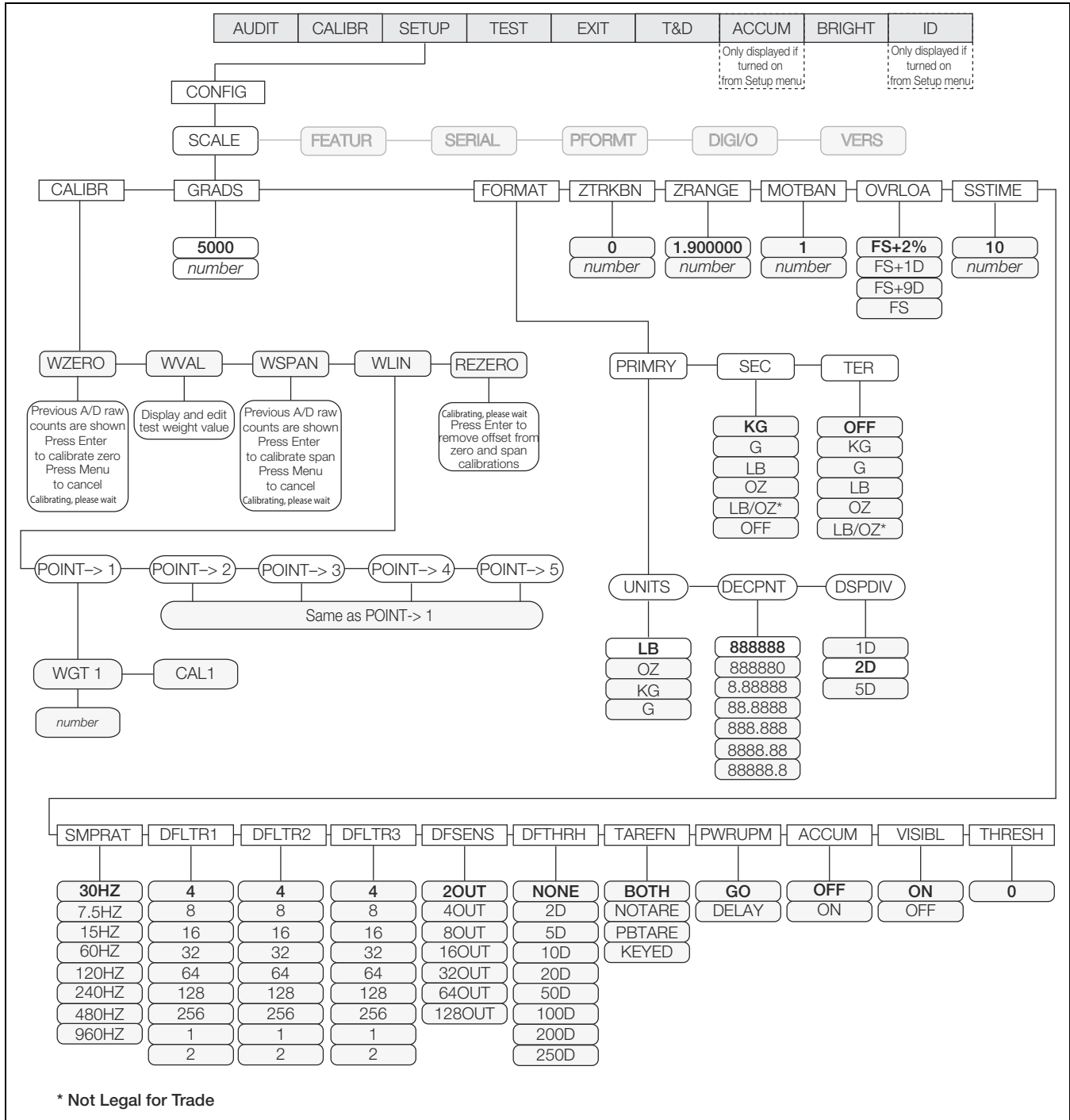

Figure 3-6. Full Scale Menu

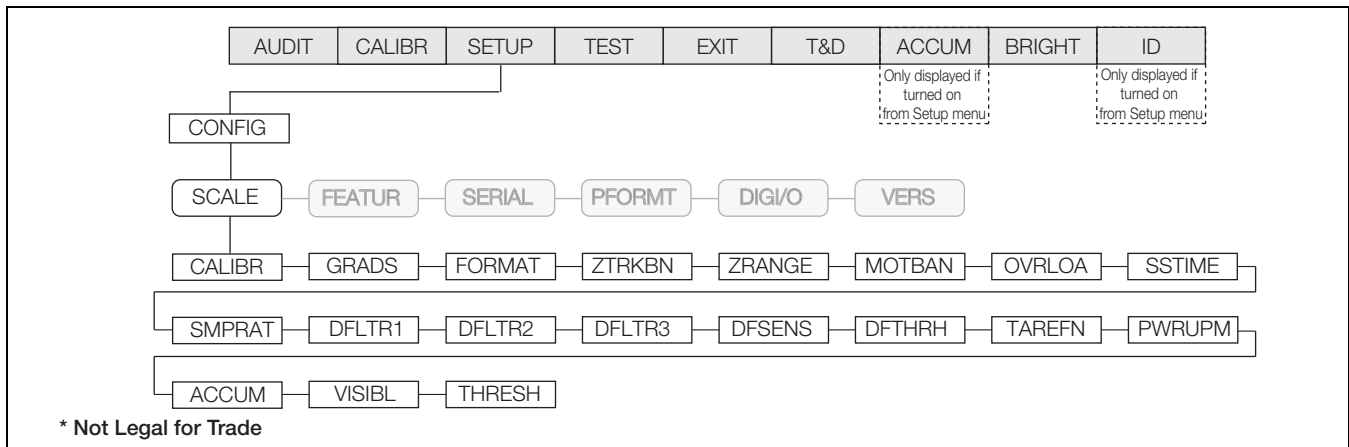

Figure 3-7. Scale Menu

Parameter	Choices	Description
CALIBR	WZERO WVAL WSPAN WLIN REZERO	See Section 3.3 on page 18 for selection descriptions and Section 4.0 on page 45 for calibration procedures; Calibration can be performed in two places within the menu: the CALIBR menu shown in Figure 3-4 on page 18 is an in-depth scale setup and calibration; Quick Access calibration is shown in Figure 4.1 on page 46 ; See Section 3.4.1.1 on page 23 for additional parameter information
GRADS	10000 1–100000	Specifies the number of full scale graduations; The value entered must be in the range 1–100000 and should be consistent with legal requirements and environmental limits on system resolution; To calculate GRADS, use the formula: GRADS = Capacity/Display Divisions ; Display divisions are specified under the FORMAT sub-menu; If RANGE is displayed after the value is entered, the value is too large or small for the given parameter
FORMAT	PRIMARY SEC TER	Select your primary, secondary, and tertiary units of measure; Sub-choices include lb, kg, oz, and g; Secondary and tertiary units can also be set to lb/oz (lb/oz is not Legal-for-Trade), or off (Table 3-7 on page 24)
ZTRKBN	0 number	Automatically zeros the scale when within the range specified, as long as the input is within the ZRANGE and scale is at standstill; Specify the zero tracking band in ± display divisions; Maximum legal value varies depending on local regulations NOTE: For scales using linear calibration, do not set the zero tracking band to a value greater than that specified for the first linearization point.
ZRANGE	1.900000 number	Selects the range within which the scale can be zeroed; The 1.900000 default value is ± 1.9% around the calibrated zero point, for a total range of 3.8%; indicator must be at standstill to zero the scale; Use the default value for Legal-for-Trade applications
MOTBAN	1 number	Sets the level, in display divisions, at which scale motion is detected; If motion is not detected for 1 second or more, the standstill symbol lights; Some operations, including print, tare, and zero, require the scale to be at standstill; Maximum legal value varies depending on local regulations; If this parameter is set to 0 the standstill annunciator does not light; Operations normally requiring standstill (zero, tare, print) are performed regardless of scale motion; If 0 is selected, ZTRKBN must also be set to 0
OVRLOA	FS+2% FS+1D FS+9D FS	Overload; determines the point at which the display blanks and an out-of-range error message is displayed; Maximum legal value varies depending on local regulations
SSTIME	10 number	Specifies the length of time the scale must be out of motion, in 0.1-second intervals, before the scale is considered to be at standstill; Values greater than 10 are not recommended
SMPRAT	30HZ 7.5HZ 15HZ 60HZ 120HZ 240HZ 480HZ 960HZ	Sample rate; selects measurement rate, in samples per second, of the analog-to-digital converter; Lower sample rate values provide greater signal noise immunity NOTE: Settings of 120Hz or above may be too fast to provide the desired stability in some static weighing applications.

Table 3-5. Scale Menu Parameters

Parameter	Choices	Description
DFLTR 1-3	4 8 16 32 64 128 256 1 2	Selects the digital filtering rate used to reduce the effects of mechanical vibration from the immediate area of the scale; The overall filtering effect can be expressed by adding the values assigned to the three filter stages: DFLTR1 + DFLTR2 + DFLTR3; See Section 8.5 on page 75 for information on digital filtering; Choices indicate the number of A/D conversions per update that are averaged to obtain the displayed reading; A higher number gives a more accurate display by minimizing the effect of a few noisy readings, but slows down the settling rate of the indicator
DFSENS	2OUT 4OUT 8OUT 16OUT 32OUT 64OUT 128OUT	Digital filter cutout sensitivity; Specifies the number of consecutive readings that must fall outside the filter threshold (DFTHR parameter) before digital filtering is suspended
DFTHR	NONE 2D 5D 10D 20D 50D 100D 200D 250D	Digital filter cutout threshold; Specifies the filter threshold in display divisions; When a specified number of consecutive scale readings (DFSENS parameter) fall outside of this threshold, digital filtering is suspended; If NONE is selected, the filter is always enabled
TAREFN	–	Enables or disables push-button and keyed tares
	BOTH	Both push-button and keyed tares are enabled
	NOTARE	No tare allowed (Gross mode only)
	PBTARE	Push-button tares enabled
	KEYED	Keyed tare enabled
PWRUPM	GO DELAY	Power-up mode; In GO mode, the indicator goes into operation immediately after a brief power up display test; In DELAY mode, the indicator performs a power up display test, then enters a 30-second warm up period; If no motion is detected during the warm up period, the indicator becomes operational when the warm up period ends; If motion is detected, the delay timer is reset and the warm up period repeated
ACCUM	OFF ON	Accumulator; specifies whether the scale accumulator is enabled; If enabled, accumulation occurs whenever a print operation is performed; Scale must return to zero to re-arm a new print
VISIBL	ON OFF	Scale visibility; Specifies whether weight data is displayed; Status annunciators, UNDER/ACCEPT/OVER lights remain on in weigh mode even if VISIBL is set to OFF
THRESH	0	Enter a value to be used as display divisions; Zero threshold allows you to select a threshold or reset point where automatic printing functions reset themselves to be re-triggered; When a display division value is entered, anything that normally requires the scale to reach zero before it happens/rearms (except for LFT parameters) now only needs to go below this display division value and then above it again NOTE: If checkweighing is used, THRESH should be less than the Under value or it can disable the digital I/O points from tripping.

Table 3-5. Scale Menu Parameters (Continued)

3.4.1.1 CALIBR Menu

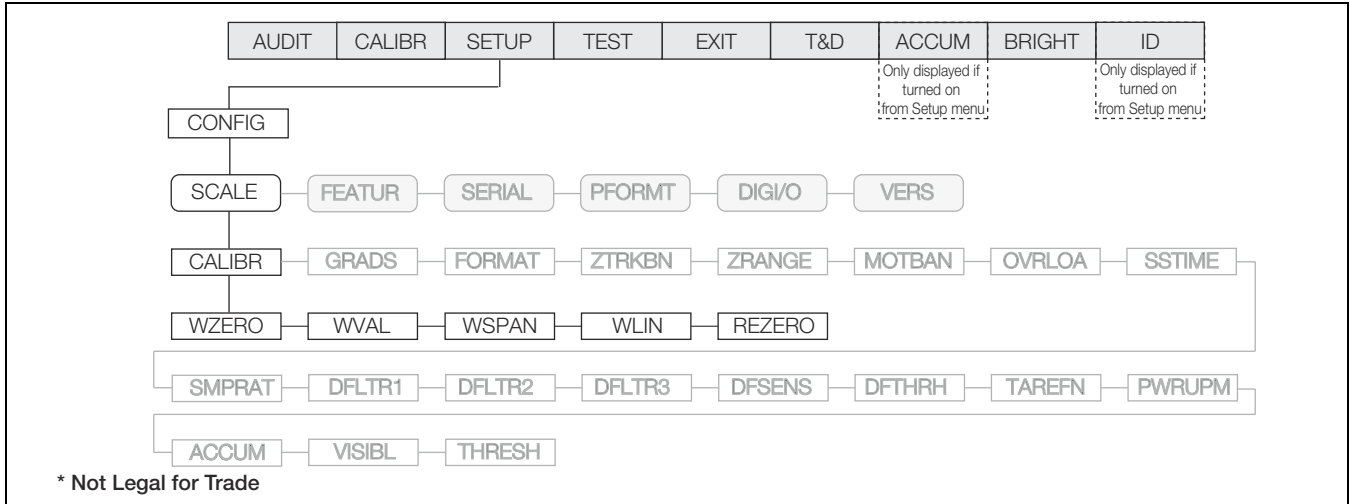

Figure 3-8. Calibration Menu

Parameter	Choices	Description
WZERO	-	Allows you to view or change the zero calibration a/d count value
WVAL	-	Allows you to view and edit the test weight value NOTE: If RANGE is displayed after the value is entered, the value is too large or small for the given parameter.
WSPAN	-	Allows you to view or change the span calibration a/d count value
WLIN	PT->1 PT->2 PT->3 PT->4 PT->5	Press the ENTER key to display and edit test weight and calibration values for up to five linearization points; Perform linear calibration only after WZERO and WSPAN have been set.
REZERO	-	Removes offset from zero and span calibrations

Table 3-6. Calibration Menu Parameters

FORMAT Menu

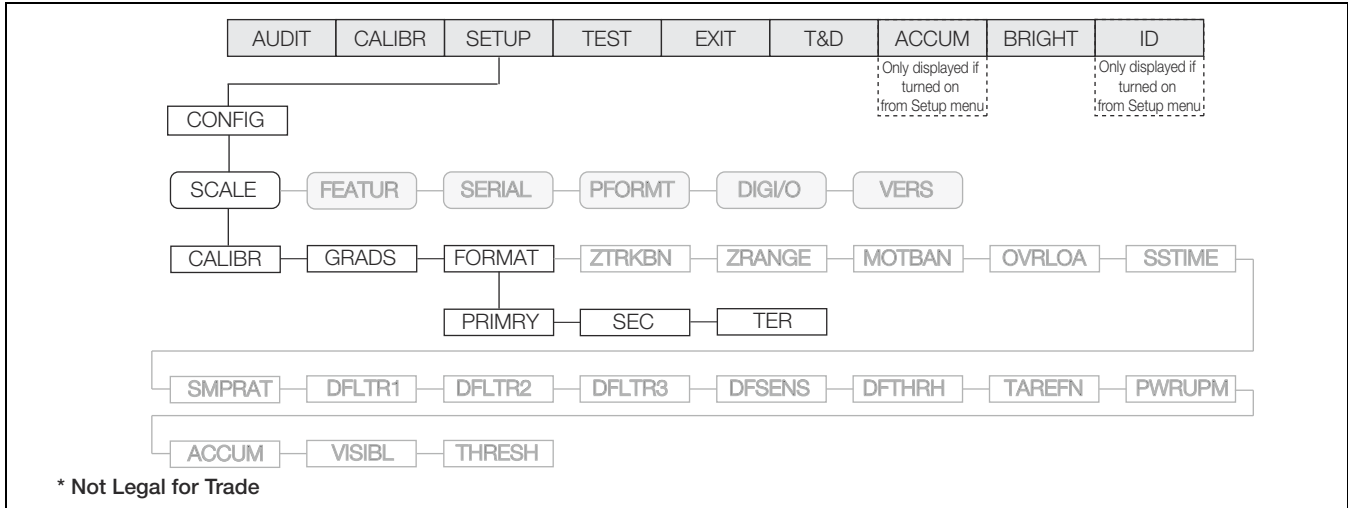

Figure 3-9. Format Menu

Parameter	Choices	Description
PRIMARY	UNITS DECPNT DSPDIV	Allows to set the primary units, decimal point format, and display divisions (Table 3-8 on page 25)
SEC	KG G LB OZ LB/OZ* OFF	Allows the ability to set the secondary units; decimal point format and display divisions are selected automatically; Values: kg=kilogram (default), g=gram, lb=pound, oz=ounce, lb/oz=pound/ounce and off (Figure 3-10 and Figure 3-11) NOTE; If using the <cu> token and secondary or tertiary values are changed, the stream tokens must be changed to match in order to stream secondary or tertiary. *LB/OZ is not Legal-for-Trade; when in LB/OZ mode, the display shows a decimal place for ounces through 99 pounds; if the pounds reach three digits (100 and above), the ounces' decimal place is dropped to accommodate the extra pounds' digit (Figure 3-10 and Figure 3-11).
TER	OFF KG G LB OZ LB/OZ*	Allows the ability to set the tertiary units; Decimal point format and display divisions are selected automatically; Values: off (default), kg=kilogram (default), g=gram, lb=pound, oz=ounce, lb/oz=pound/ounce and off (Figure 3-10 and Figure 3-11) NOTE; If using the <cu> token and secondary or tertiary values are changed, the stream tokens must be changed to match in order to stream secondary or tertiary. *LB/OZ is not Legal-for-Trade. When in LB/OZ mode, the display shows a decimal place for ounces through 99 pounds. If the pounds reach three digits (100 and above), the ounces' decimal place is dropped to accommodate the extra pounds' digit (Figure 3-10 and Figure 3-11).
<div style="border: 1px solid black; padding: 5px;"> <p>IMPORTANT If using a regulatory mode (Section 8.6 on page 77), it is the installers responsibility to make sure the maximum allowable number of divisions is not exceeded by primary, secondary or tertiary units of measure. In this situation, the installer must reduce the number of divisions (also reducing the maximum displayed capacity of the indicator) of the broader unit of measure to make sure both units are less than the allowed maximum per regulatory accreditation</p> </div>		

Table 3-7. Format Menu Parameters

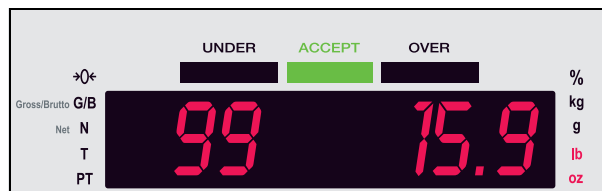

Figure 3-10. LB/OZ Mode Display Through 99 lbs

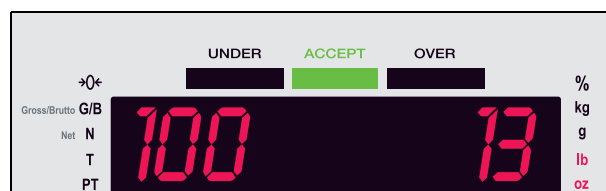

Figure 3-11. LB/OZ Mode Display for 100 lbs and Above

PRIMARY Menu

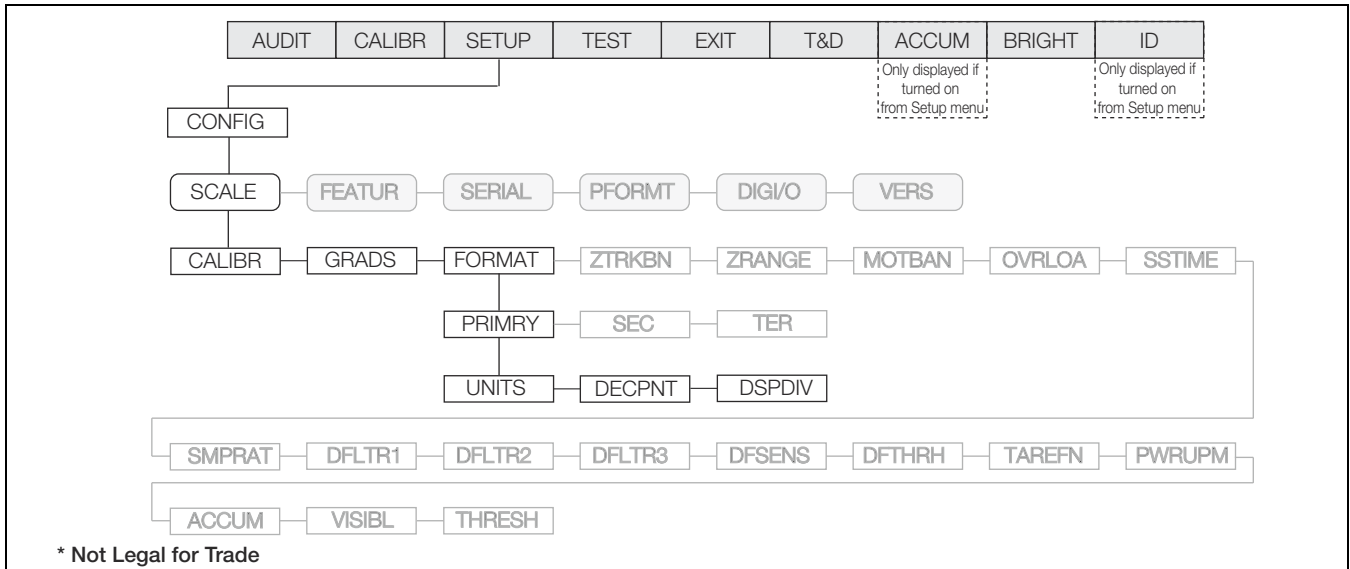

Figure 3-12. Primary Menu

Parameter	Choices	Description
UNITS	LB OZ KG G	Specifies primary units for displayed and printed weight; Values: lb=pound; oz=ounce; kg=kilogram; g=gram
DECPNT	888888 88888.8 8888.88 888.888 888880 8.88888 88.8888	Allows you to place the decimal point position; use the ID (<) and TARGET (>) keys to place the decimal point where desired
DSPDIV	1D 2D 5D	Display divisions; Selects the minimum division size for the primary unit's displayed weight

Table 3-8. Primary Menu Parameters

3.4.2 FEATUR Menu

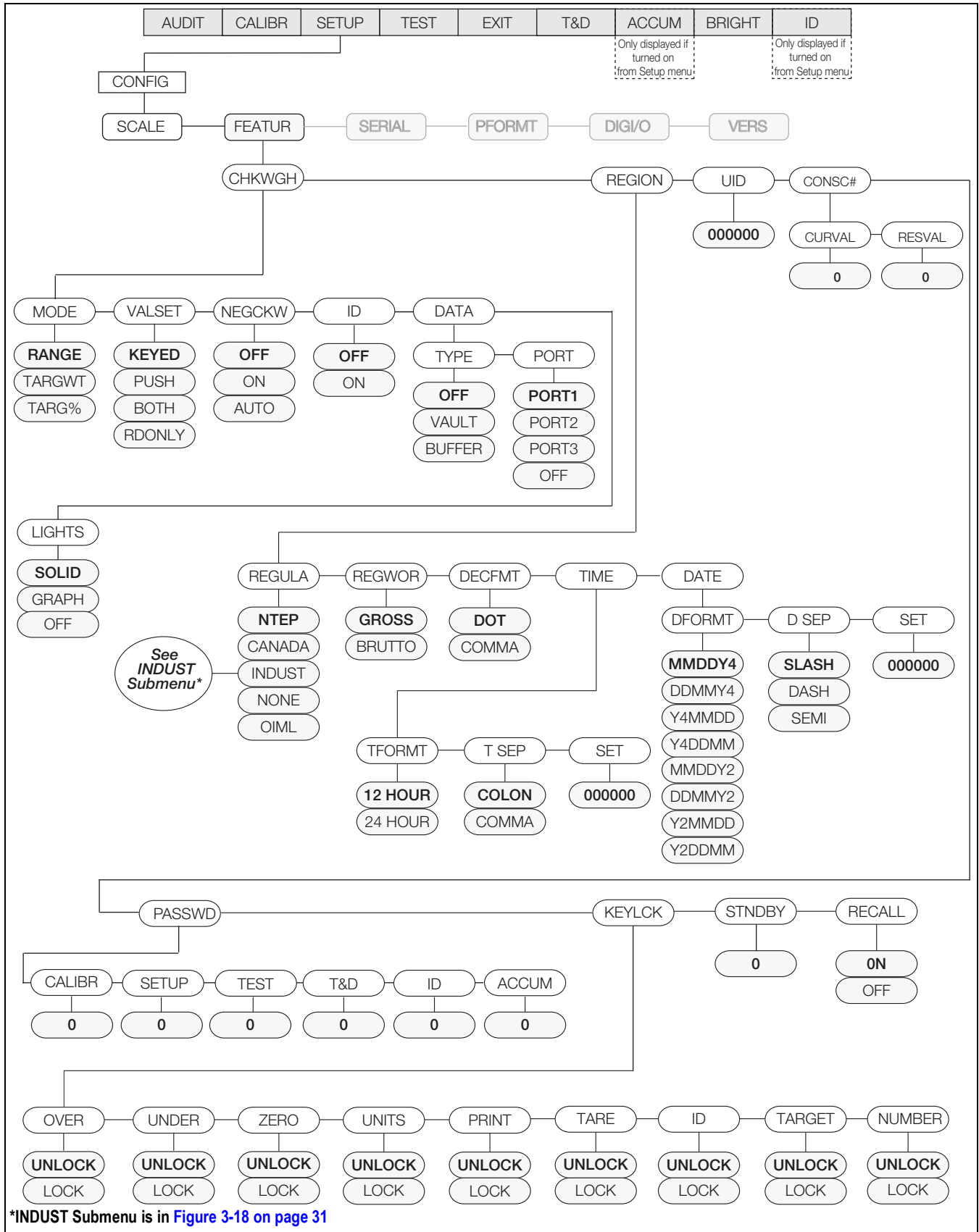

Figure 3-13. Full Feature Menu

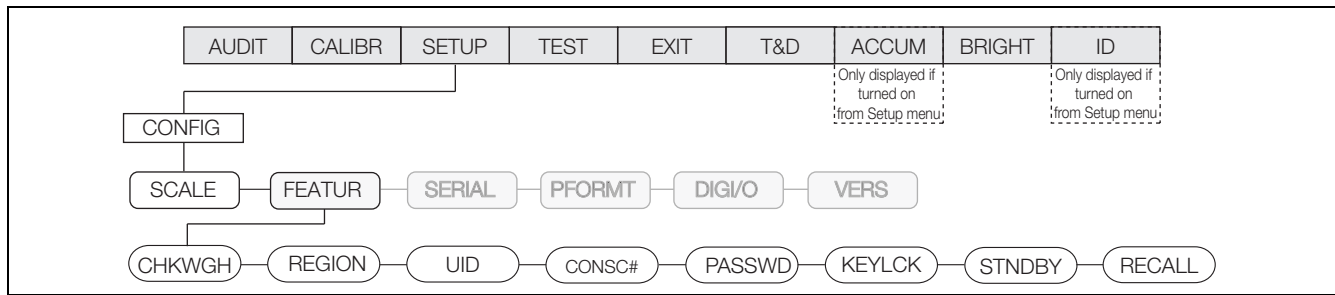

Figure 3-14. Feature Menu

Parameter	Choices	Description
CHKWGH	MODE VALSET NEGCKW ID DATA LIGHTS	Selects the checkweighing mode (range, target weight, or target percent); Controls how values are set; Enables/disables negative checkweighing; Enables/disables IDs; Turns data parameters on/off; Sets the lights as a solid bar or graph representation (Table 3-10 on page 28); See Section 3.4.2.1 on page 28 for parameter information NOTE: The buffer can store approx. 64KB of information, which is 500 transactions using a format with 120 characters of output.
REGION	REGULA REGWRD DECfmt TIME DATE	Selects regional settings (Table 3-12 on page 30); See Section 3.4.2.2 on page 30 for parameter information
UID	000000	Sets the unit ID, a string of up to 6 ASCII characters, which can be set via serial port or keypad; This will be used in place of the <UID> token in a print format; The default value is 1
CONSEC #	CURVAL RESVAL	Allows sequential numbering for print operations (CURVAL is the current value and RESVAL is the reset value); The consecutive number value is incremented following each print operation that includes <CN> in the ticket format; When the consecutive number is reset, it is reset to the RESVAL specified on the parameter; See Section 3.4.2.3 on page 33 for parameter information
PASSWD	CALIBR SETUP TEST T&D ID ACCUM	Creates a password to access the CALIBR, SETUP, TEST, T&D, ID, and ACCUM menus; Specify a non-zero value to restrict access to all configuration menus; passwords can be overridden by loading new firmware or entering 999999 (Table 3-17 on page 34) NOTE: Overriding passwords will clear configuration and calibration settings. To preserve settings (i.e., ID information), use Revolution software to upload your data to a PC, then download it back to the CW-90 after the password override is performed.
KEYLCK	OVER UNDER ZERO UNITS PRINT TARE ID TARGET NUMBER	Disables the OVER, UNDER, ZERO, UNITS, PRINT, TARE, ID, TARGET, and/or numeric (CW-90 only) key(s); Select Lock to disable the key, and Unlock to enable the key; See Section 3.4.2.5 on page 34 for parameter information
STNDBY	0	Standby mode delay; specifies the number of minutes the indicator must be inactive before entering standby mode; Valid values are 0 (off) through 255 minutes; When in standby mode, power is still supplied to the CPU and draws 1/2 of the current as when the display is powered; The annunciators are still lit, but no weight is displayed; Press any key to exit standby mode and reactivate the display; The indicator enters standby mode if no key presses, serial communications, or scale motion occur for the length of time specified in this parameter; Set to 0 to disable Standby mode NOTE: Standby mode will not be implemented if there is weight on the scale.
RECALL	ON OFF	ON allows the Tare, Zero, and Units values to be maintained across a power cycle; Over/Under/Target/ID values are also maintained; OFF clears the values on a power cycle; Zero is reset to calibrated zero and Units are reset to Primary; Over/Under/Target/ID values are reset as well

Table 3-9. Feature Menu Parameters

3.4.2.1 CHKWGH Menu

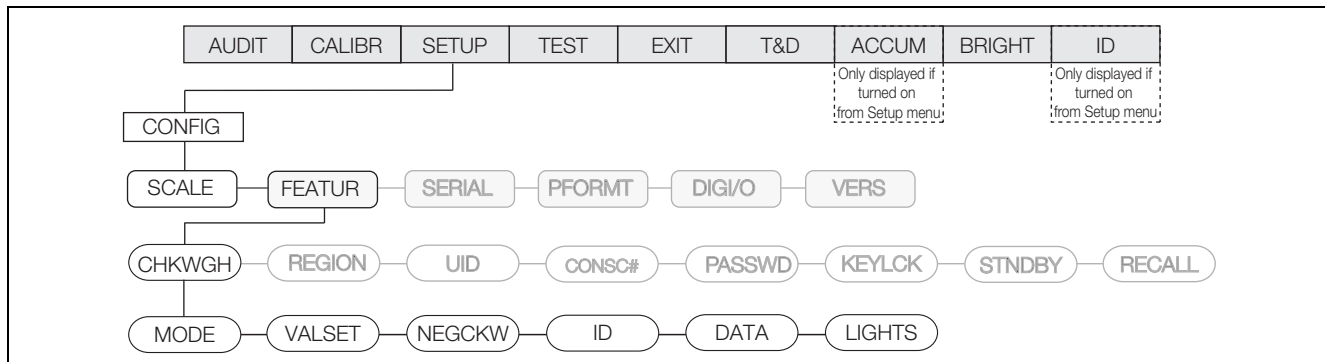

Figure 3-15. Checkweigh Menu

Parameter	Choices	Description
MODE	RANGE TARGWT TARG%	Sets checkweighing mode to range, target weight, or target percent; See Section 5.0 on page 50 for more information
VALSET	KEYED	Allows the operator to digitally set the Accept band tolerance values using keypad buttons while in Normal Weighing mode
	PUSH	Prohibits the operator from digitally entering values with the keypad; Requires the operator to place actual weights on the scale then press keypad buttons to acquire lower and upper Accept band tolerance values
	BOTH	A combination mode that allows the operator to have the CW-90/90X acquire Accept band tolerances from actual weights on the scale, but then gives the operator an opportunity to digitally modify those values directly afterward
	RONLY	A “read only” mode allows the operator to see the values but does not allow for values to be modified
NEGCKW	OFF ON AUTO	Sets whether negative checkweighing mode is off, on, or is using auto-tare
ID	OFF ON	Turns IDs on or off; See Section 5.4 on page 55 for more information on IDs; If IDs are turned off, the ID selection will not appear in the main menu structure
DATA	TYPE PORT	Selects the data type and port number for that data type; See Table 3-11 on page 29 for parameter information
LIGHTS	SOLID GRAPH OFF	Select SOLID if you want the checkweigher to display a solid light bar for over and under weights; Select GRAPH if you want it to illuminate lights in increments relative to how close the weight is the acceptance band; Select OFF if you want the lights to never be illuminated; See Section 1.7 on page 4 for an illustration of graph LEDs

Table 3-10. Checkweigh Menu Parameters

DATA Menu

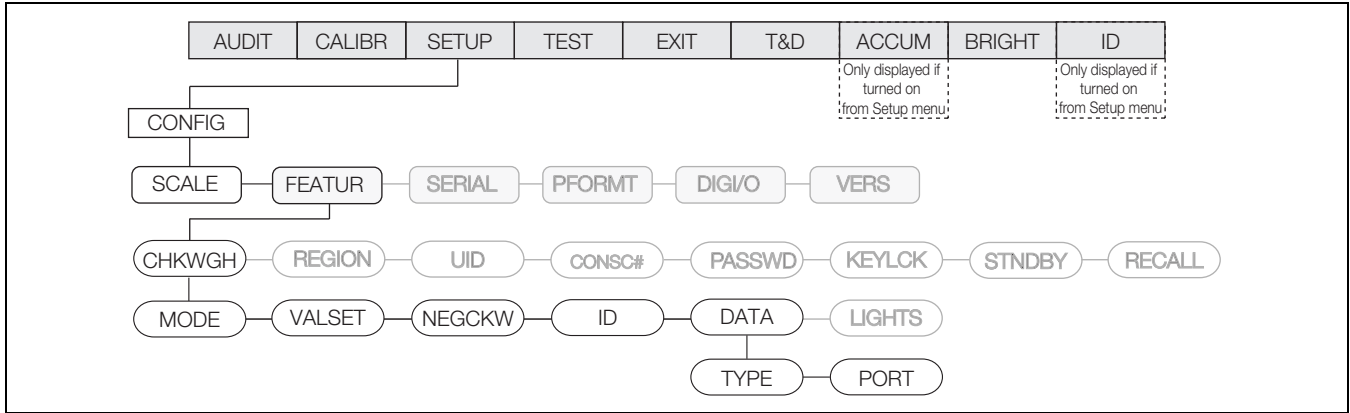

Figure 3-16. Data Menu

Parameter	Choices	Description
TYPE	OFF VAULT BUFFER	OFF – Disables data buffering VAULT – Enables operation with the WeighVault® PC application BUFFER – Stores (buffers) automatic print data to memory for later retrieval
PORT	PORT1 PORT2 PORT3 OFF	Selects the port number

Table 3-11. Data Menu Parameters

3.4.2.2 REGION Menu

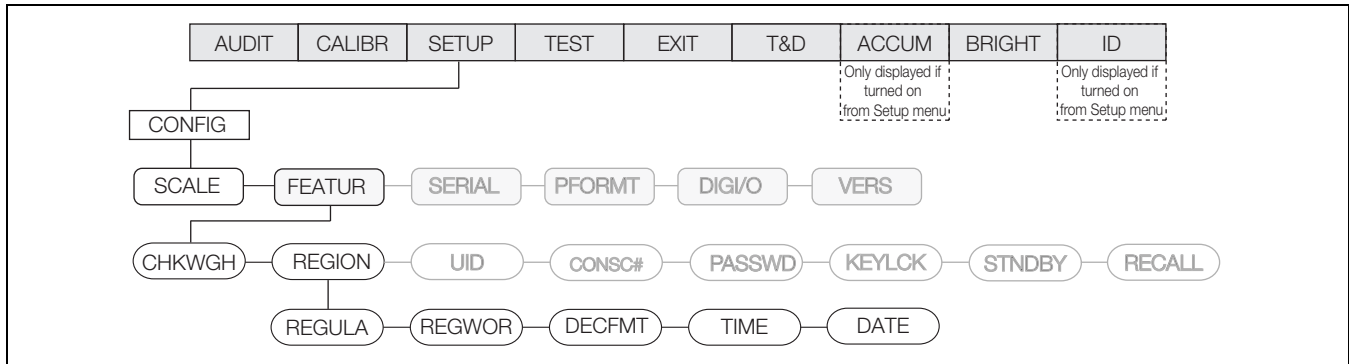

Figure 3-17. Region Menu

Parameter	Choices	Description
REGULA	NTEP CANADA INDUST NONE OIML	Regulatory mode; Specifies the regulatory agency having jurisdiction over the scale site NOTE: The value specified for REGULA affects the function of the front panel TARE and ZERO keys. <ul style="list-style-type: none"> OIML, NTEP, and CANADA modes allow a tare to be acquired at any weight greater than zero; NONE allows tares to be acquired at any weight value OIML, NTEP, and CANADA modes allow a tare to be cleared only if the gross weight is at no load; NONE allows tares to be cleared at any weight value NTEP and OIML modes allow a new tare to be acquired even if a tare is already present; In CANADA mode, the previous tare must be cleared before a new tare can be acquired NONE, NTEP and CANADA modes allow the scale to be zeroed in either gross or net mode as long as the current weight is within the specified ZRANGE; In OIML mode, the scale must be in gross mode before it can be zeroed; Pressing the ZERO key in net mode clears the tare INDUST provides a set of subparameters to allow customization of tare, clear, and print functions in non-Legal-for-Trade scale installations
REGWOR	GROSS BRUTTO	Sets the term displayed when weighing in gross mode; Selecting BRUTTO replaces Gross annunciator with Brutto
DECFMT	DOT COMMA	Specifies whether decimal numbers are displayed using a period (DOT) or a comma
TIME	TFORMT TSEP SET	Allows you to set the current time, and the time format and separator character; See Table 3-14 on page 32 for parameter information
DATE	DFORMT D SEP SET	Allows you to set the current date, and date format and date separator character; See Table 3-15 on page 33 for parameter information

Table 3-12. Region Menu Parameters

REGULA Menu

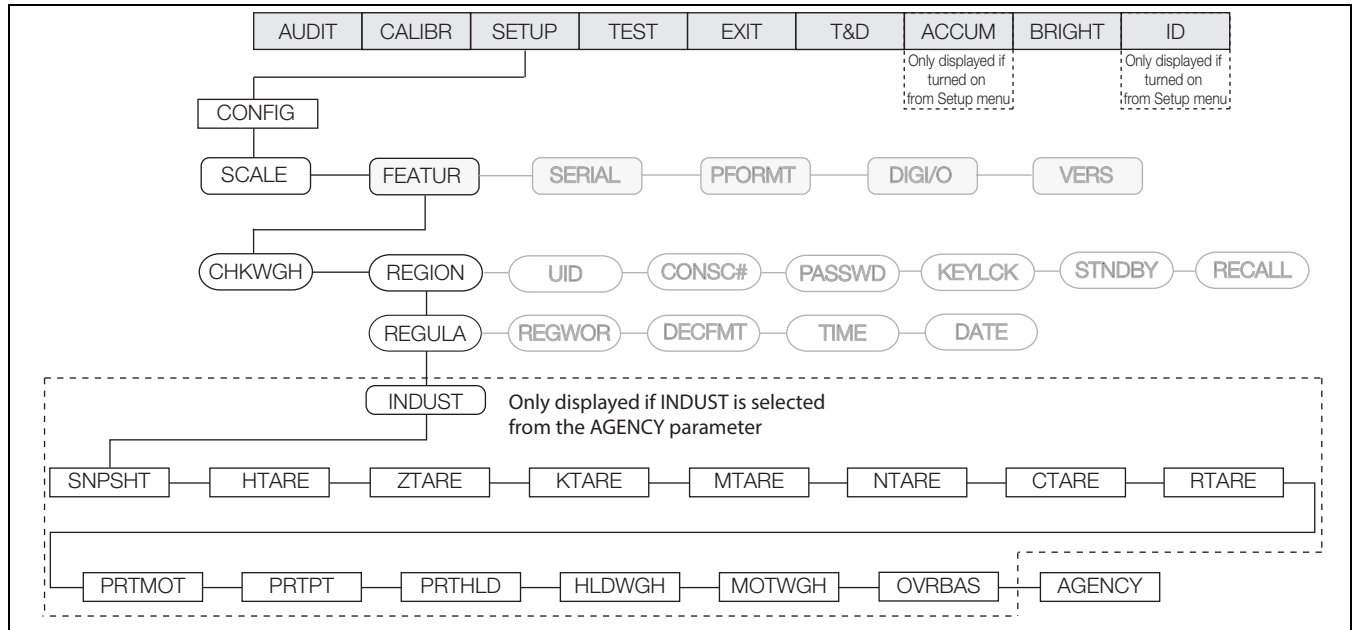

Figure 3-18. Regulation Menu

Parameter	Choices	Description
SNPSHT	DISPLY SCALE	Display or Scale weight source
HTARE	NO, YES	Allow tare in display hold
ZTARE	NO, YES	Remove tare on ZERO
KTARE	YES, NO	Always allow keyed tare
MTARE	REPLAC REMOVE NOTHIN	Multiple tare action
NTARE	NO, YES	Allow negative or zero tare
CTARE	YES, NO	Allow CLEAR key to clear tare/accumulator
RTARE	YES, NO	Round push button tare to the nearest display division
PRTMOT	NO, YES	Allow print while in motion
PRTPT	NO, YES	Add PT to keyed tare print
PRTHLD	NO, YES	Print during display hold
HLDWGH	NO, YES	Allow weighment during display hold
MOTWGH	NO, YES	Allow weighment in motion
OVRBAS	CALIB SCALE	Zero base for overload calculation CALIB = Calibrate Zero SCALE = Scale Zero

Table 3-13. Regulation Menu

Parameter	Choices	Description
AGENCY	NTEP CANADA INDUST NONE OIML	<p>Selects the agency having jurisdiction over the scale site</p> <ul style="list-style-type: none"> OIML, NTEP, and CANADA modes allow a tare to be acquired at any weight greater than zero; NONE allows tares to be acquired at any weight value; A tare can be cleared only if the gross weight is at no load; NONE allows tares to be cleared at any weight value NTEP and OIML modes allow a new tare to be acquired even if a tare is already present; In OIML mode, printing is not allowed if the scale is more than -20 dd; In CANADA mode, the previous tare must be cleared before a new tare can be acquired NONE, NTEP and CANADA modes allow the scale to be zeroed in either gross or net mode as long as the current weight is within the specified ZRANGE; In OIML mode, the scale must be in gross mode before it can be zeroed; Pressing ZERO in net mode clears the tare INDUST provides a set of subparameters to allow customization of tare, clear, and print functions in non-Legal-for-Trade applications <p>The value specified for this parameter affects the function of the front panel TARE and ZERO keys; See Section 8.6 on page 77 for more information</p>

Table 3-13. Regulation Menu (Continued)

TIME Menu

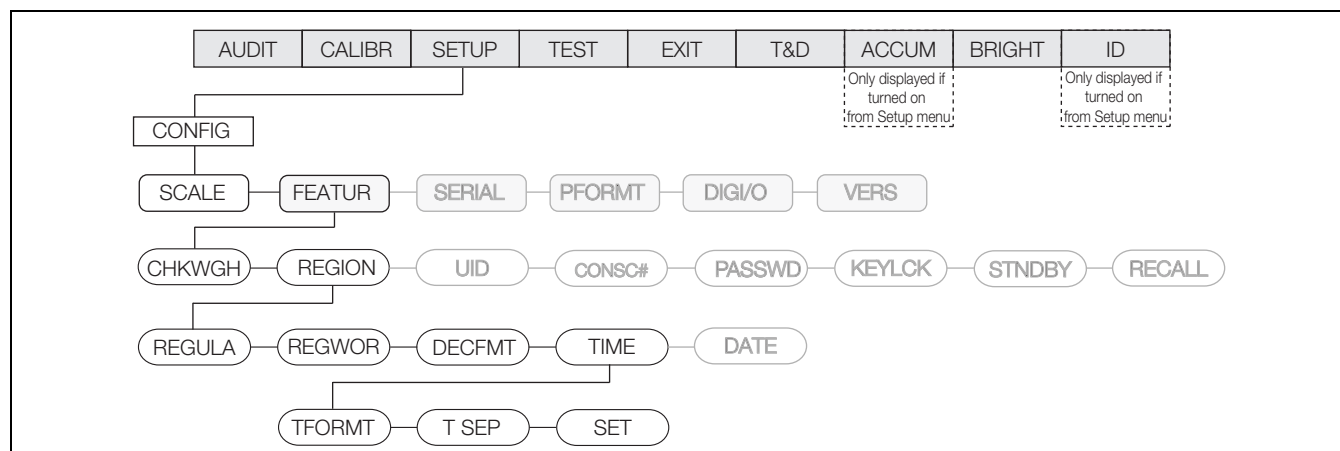

Figure 3-19. Time Menu

Parameter	Choices	Description
TFORMT	12 HOUR 24 HOUR	Sets the time format as 12-hour format or 24-hour format
T SEP	COLON COMMA	Sets the time separator as a colon or comma
SET	000000	Sets the current time

Table 3-14. Time Menu Parameters

DATE Menu

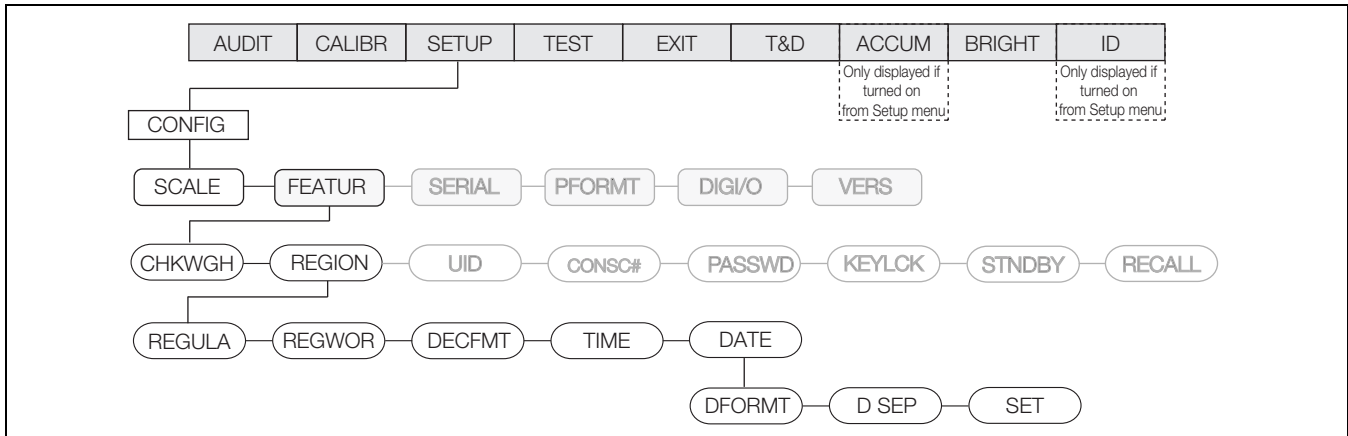

Figure 3-20. Date Menu

Parameter	Choices	Description
DFORMAT	MMDDY4 DDMMY4 Y4MMDD Y4DDMM MMDDY2 DDMMY2 Y2MMDD Y2DDMM	Sets the date format; Y4 will use a four-digit year value, such as 2009, while Y2 will use a two-digit value, such as 09
D SEP	COLON COMMA	Sets the date separator as a slash, dash, or semicolon
SET	000000	Sets the current time

Table 3-15. Date Menu Parameters

3.4.2.3 CONSC# Menu

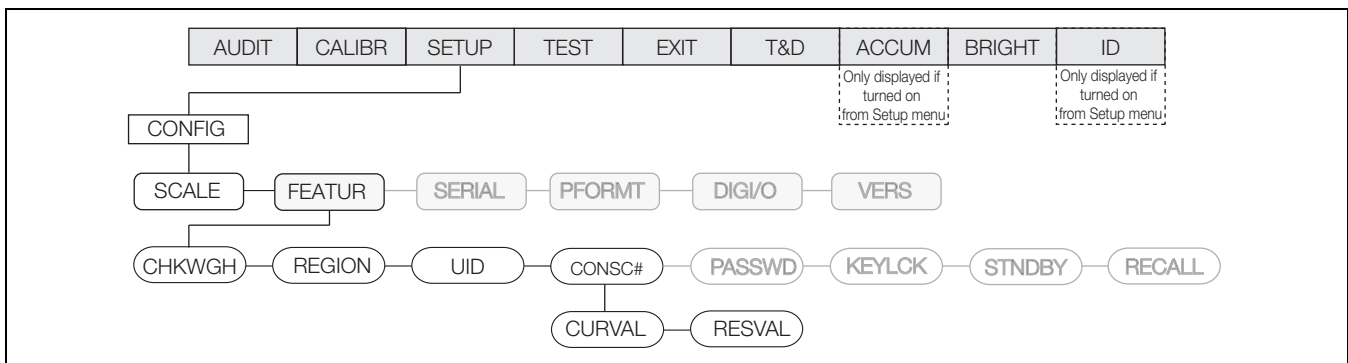

Figure 3-21. Consecutive Number Menu

Parameter	Choices	Description
CURVAL	-	Current value – Sets the current value; The current value
RESVAL	-	Reset value – Sets the reset value

Table 3-16. Consecutive Number Menu Parameters

3.4.2.4 PASSWD Menu

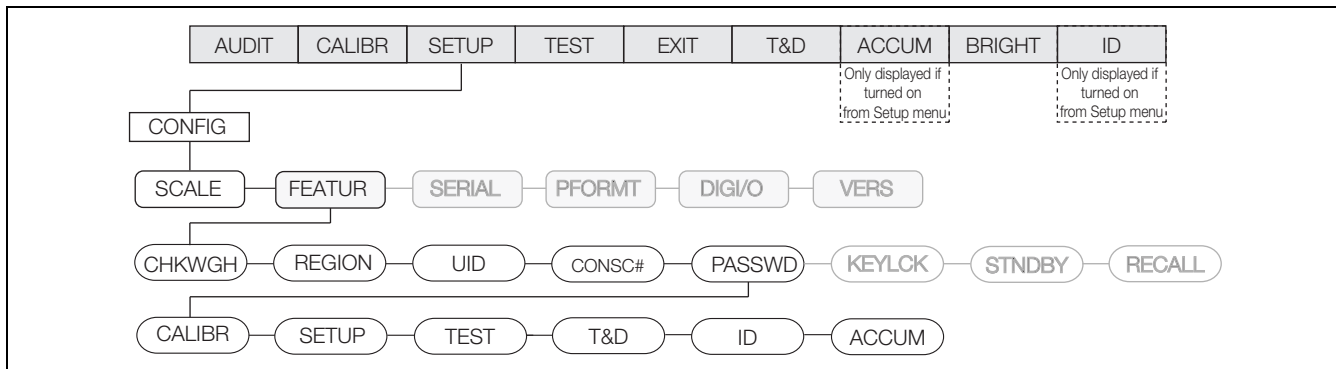

Figure 3-22. Password Menu

Parameter	Choices	Description
CALIBR SETUP TEST T&D ID ACCUM	-	Sets a password for the Calibrate, Setup, Test, T&D, ID, and Accum menu(s); Specify a non-zero value to restrict access; Passwords can be overridden by loading new firmware or entering 999999 NOTE: Overriding passwords will clear configuration and calibration settings. To preserve settings (i.e., ID information), use Revolution software to upload your data to a PC, then load it back to the CW-90 after the password override is performed.

Table 3-17. Password Menu Parameters

3.4.2.5 KEYLCK Menu

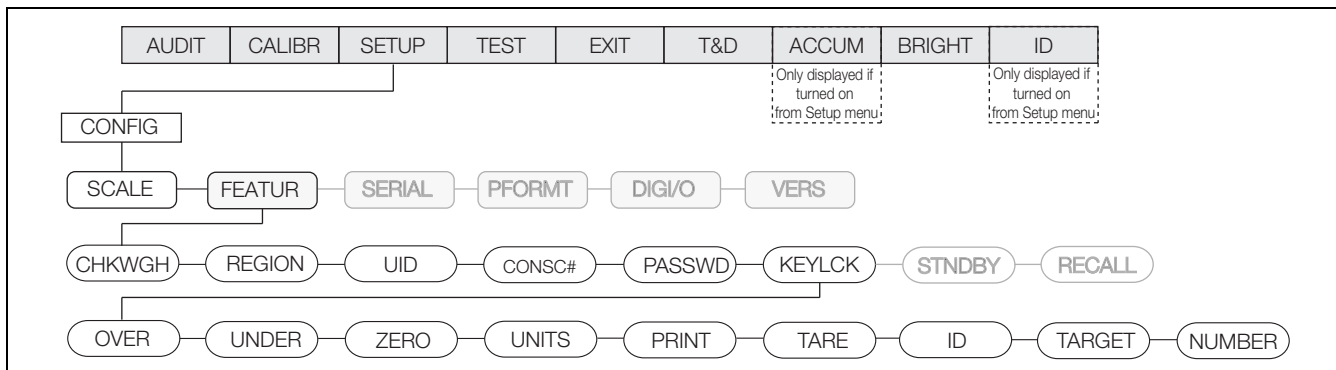

Figure 3-23. Keylock Menu

Parameter	Choices	Description
OVER UNDER ZERO UNITS PRINT TARE ID TARGET NUMBER	UNLOCK LOCK	Locks or unlocks the OVER, UNDER, ZERO, UNITS, PRINT, TARE, ID, TARGET, and numeric button(s)

Table 3-18. Keylock Menu Parameters

3.4.3 SERIAL Menu

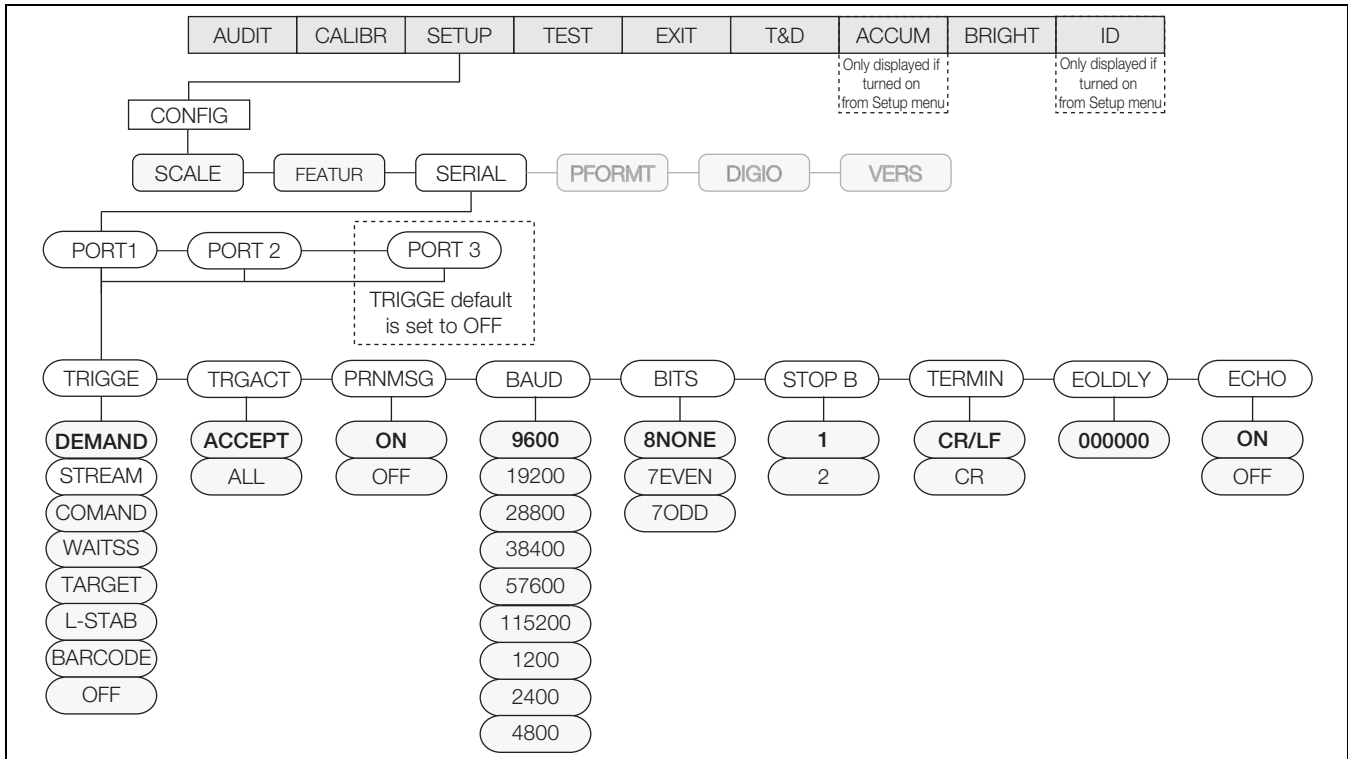

Figure 3-24. Full Serial Menu

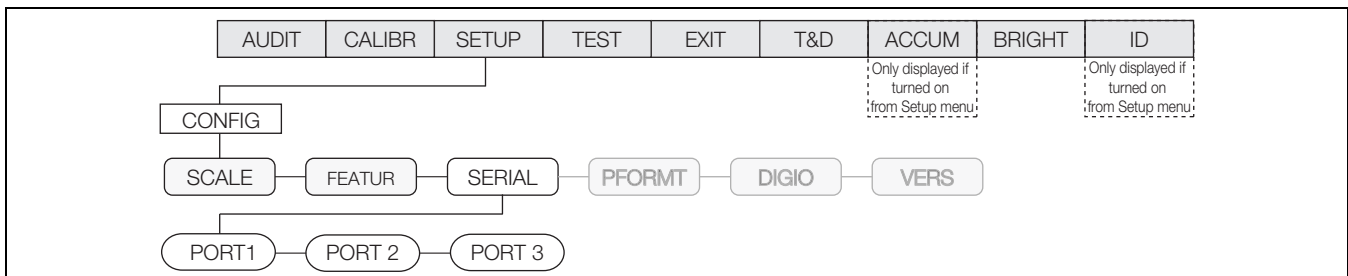

Figure 3-25. Serial Menu

Parameter	Choices	Description
Port 1	TRIGGE PRNMSG BAUD	Specifies Port 1's mechanism for triggering a transmission of data, print message, baud rate, bits, stop bits, termination character, end-of-line delay, and echo (Figure 3-26 on page 36) NOTE: If any port is set to PRNMSG=ON, PRINT will display.
Port 2	BITS STOP B TERMIN	Specifies Port 2's mechanism for triggering a transmission of data, print message, baud rate, bits, stop bits, termination character, end-of-line delay, and echo (Figure 3-26 on page 36) NOTE: If any port is set to PRNMSG=ON, PRINT will display.
Port 3	EOLDLY ECHO	Specifies Port 3's mechanism for triggering a transmission of data, print message, baud rate, bits, stop bits, termination character, end-of-line delay, and echo (Figure 3-26 on page 36) NOTE: If any port is set to PRNMSG=ON, PRINT will display.

Table 3-19. Serial Menu Parameters

3.4.3.1 PORT Menu

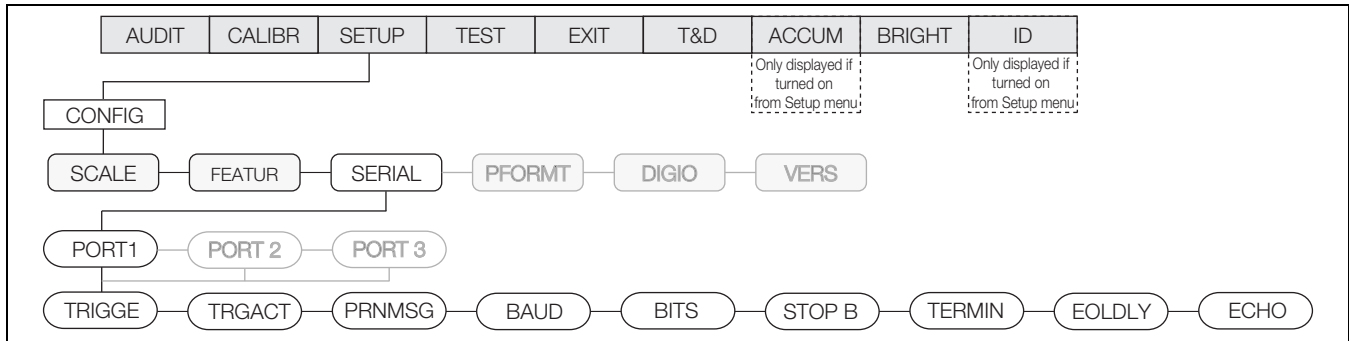

Figure 3-26. Port Menu

Parameter	Choices	Description
TRIGGE	DEMAND	DEMAND will send information out of the port only when the Print key is pressed
	STREAM	Allows a continuous flow of information out of the port
	COMAND	Allows operation of EDP commands, but will not print (DEMAND accepts commands and prints)
	WAITSS	Wait for Standstill Print: Automatically print when the weight is stable above the zero band and within the range set by the Trigger Action parameter. Once a print is performed, the weight must go into motion before it is able to print again.
	TARGET	Target Print: Automatically print the first stable weight that is above the zero band and within the range set by the Trigger Action parameter. Once a print is performed, the weight must go into the zero band (below the Threshold value) before it is able to print again.
	L-STAB	Last Stable Print: Automatically print the last stable weight that was above the zero band and within the range set by the Trigger Action parameter. If using Trigger Action = All, once a print is performed the weight must go into the zero band (below the Threshold value) before it is able to print again. When Trigger Action = Accept, once a print is performed the weight must exit the accept range before it is able to print again.
	BARCODE	Handles incoming data as if the ID was just pressed. Numbers are treated as the ID number. The barcode can be composed of only four numbers with a CR. Leading zeros are automatically removed.
	OFF	A setting of OFF will disable the port.
TRGACT	ACCEPT ALL	Trigger Action: ACCEPT only triggers on values in the accept range. ALL works with Accept, Under, and Over. NOTE: TRGACT relates only to WAITSS, TARGET, and L-STAB. DEMAND, STREAM, COMMAND, and BARCODE ignore how TRGACT is set.
PRNMSG	ON OFF	Print Message: ON will show the print message on the display every time the unit sends the Print command. OFF will not display the print message.
BAUD	9600 19200 28800 38400 57600 115200 1200 2400 4800	Baud Rate: Selects the transmission speed for the port.
BITS	8NONE 7EVEN 7ODD	Selects number of data bits and parity of data transmitted from the port.
STOP B	1 2	Stop Bits: Sets the number of stop bits to 1 or 2.
TERMIN	CR/LF CR	Termination Character(s): Selects termination character(s) for data sent from the port.

Table 3-20. Port Menu Parameters

Parameter	Choices	Description
EOLDLY	000000	End-of-line Delay: Sets the delay period, in 0.1-second intervals, from when a formatted line is terminated to the beginning of the next formatted serial output. Value specified must be in the range 0-255, in tenths of a second (10 = 1 second). NOTE: An EOL may be required for continuous transmission at slower baud rates to ensure the receiving buffer is empty before another string is transmitted.
ECHO	ON OFF	This command enables or disables echoing of the serial commands sent to the indicator.

Table 3-20. Port Menu Parameters

3.4.4 PFORMT Menu

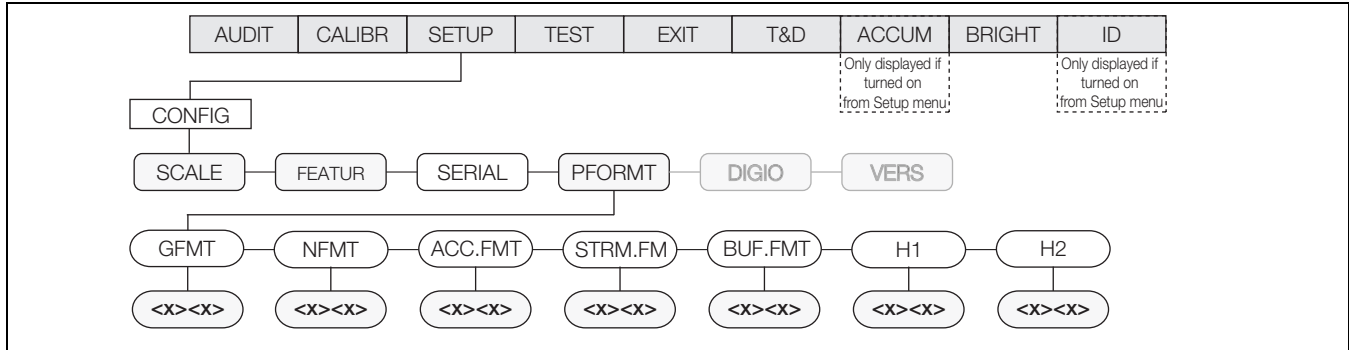

Figure 3-27. Full Print Format Menu

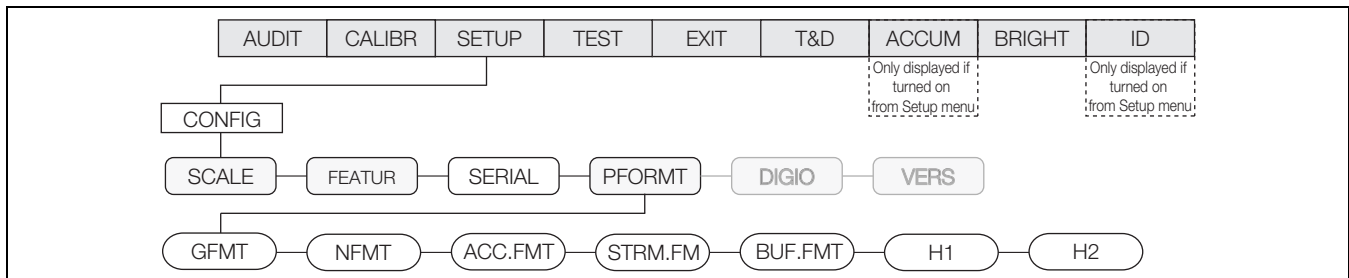

Figure 3-28. Print Format Menu

Parameter	Choices	Description
GFMT	-	Sets the print format for gross weight
NFMT	-	Sets the print format for net weight
ACCFMT	-	Sets the print format for accumulated weight
STRM.FM	-	Sets the print format for stream
BUF.FMT	-	Sets the print format for buffer
H1	-	Sets the print format for Header 1
H2	-	Sets the print format for Header 2

Table 3-21. Print Format Menu Parameters

3.4.5 DIGIO Menu

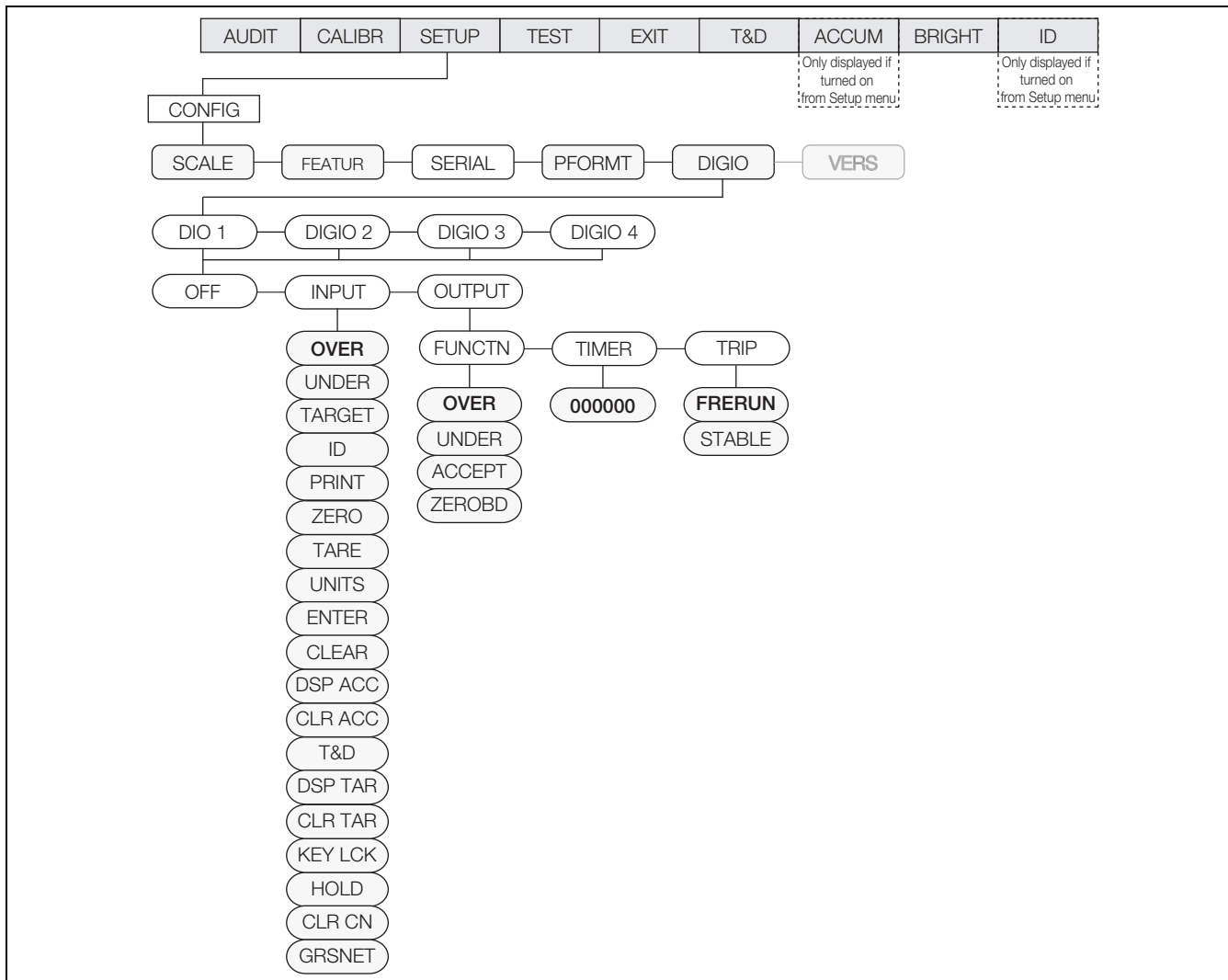

Figure 3-29. Full Digital Input/Output Menu

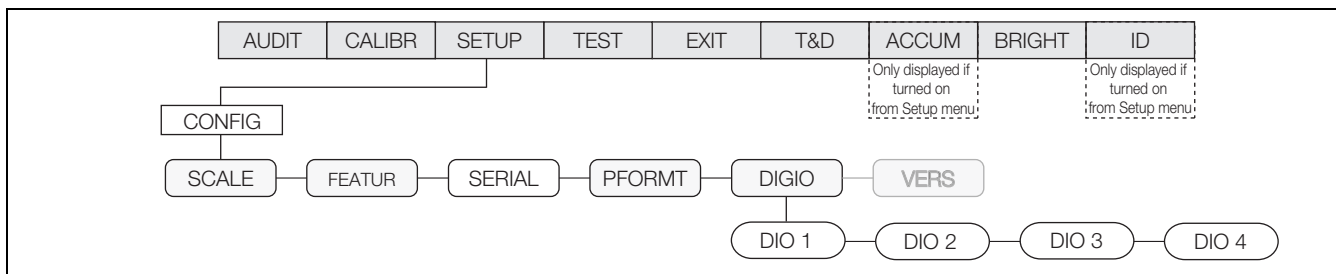

Figure 3-30. Digital Input/Output Menu

Parameter	Choices	Description
DIG IO	DIO 1 DIO 2 DIO 3 DIO 4	Assign the digital input/output functions; See Section 3.4.6 on page 39

Table 3-22. DIO Menu Parameters

3.4.6 DIO Menu

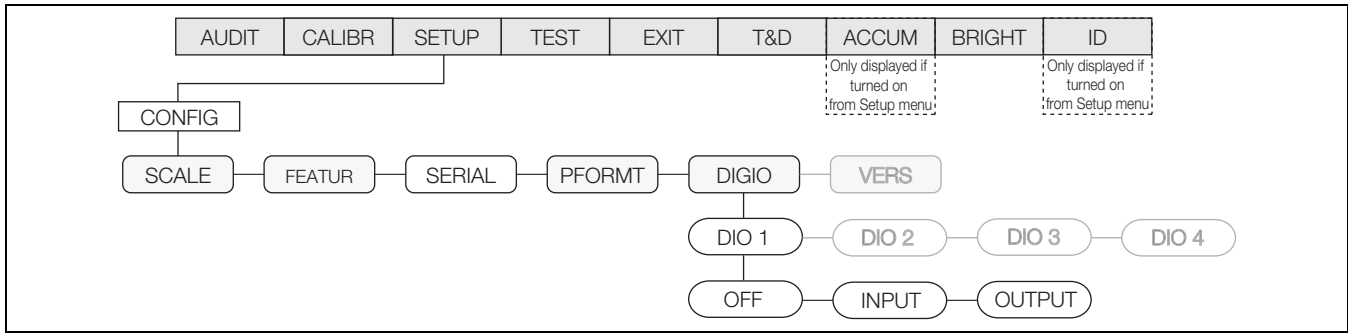

Figure 3-31. Digital Input/Output Menu

Parameter	Choices	Description
OFF	–	Disables the digital input/output
INPUT	OVER UNDER TARGET ID PRINT ZERO TARE UNITS ENTER CLEAR DSPACC CLRACC T&D DSPTAR CLRTAR KEYLCK HOLD CLRCN GRSNET	Digital input functions
OUTPUT	FUNCTN TIMER TRIP	Digital output functions; See (Figure 3-32 on page 40); See Table 3-24 on page 40 for parameter information

Table 3-23. Digital Input/Output Menu Parameters

3.4.6.1 Output Menu

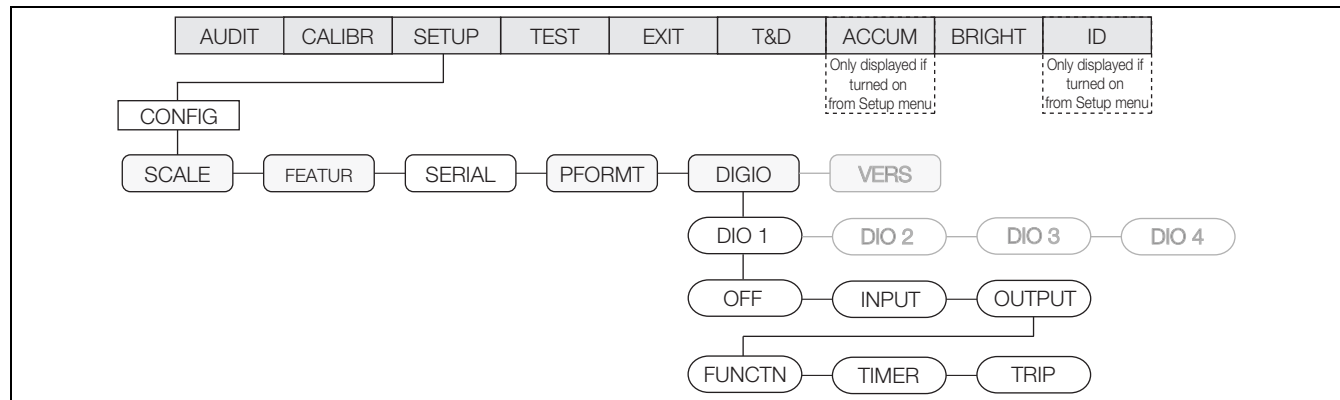

Figure 3-32. Output Menu

Parameter	Choices	Description
FUNCTN	OVER UNDER ACCEPT ZEROBD	Sets the output to function when a value in the over, under, accept, or zero band is reached
TIMER	000000	Set the timer to 0 for output to remain on until the function state changes; Enter a value (in 20-millisecond increments, maximum 65535) to turn the digital output off after the specified time (even though the function state has not changed)
TRIP	FRERUN	Activates the output when the weight is at standstill or in motion
	STABLE	Activates the output when the weight is at standstill

Table 3-24. Output Menu Parameters

3.4.7 VERS Menu

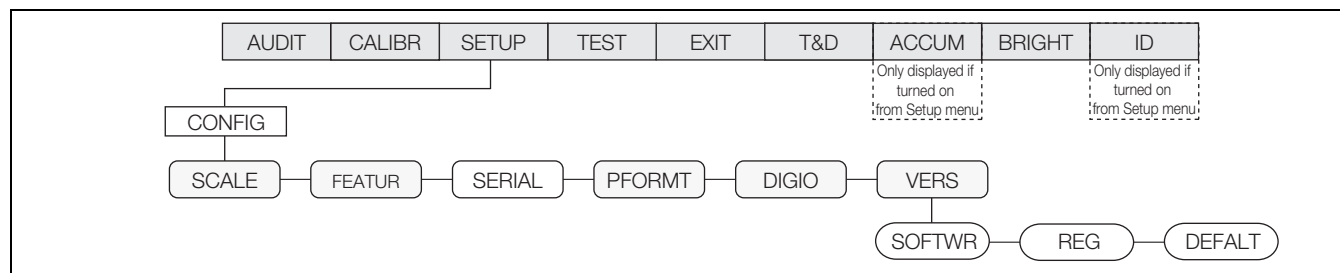

Figure 3-33. Version Menu

Parameter	Choices	Description
SOFTWR	V 1.00	Displays the software version (read-only)
REG	LR,V.1.00	Displays the legally relevant version (read-only)
DEFAULT	NO YES	Resets settings to default values if YES is selected

Table 3-25. Version Menu Parameters

3.5 Test Menu

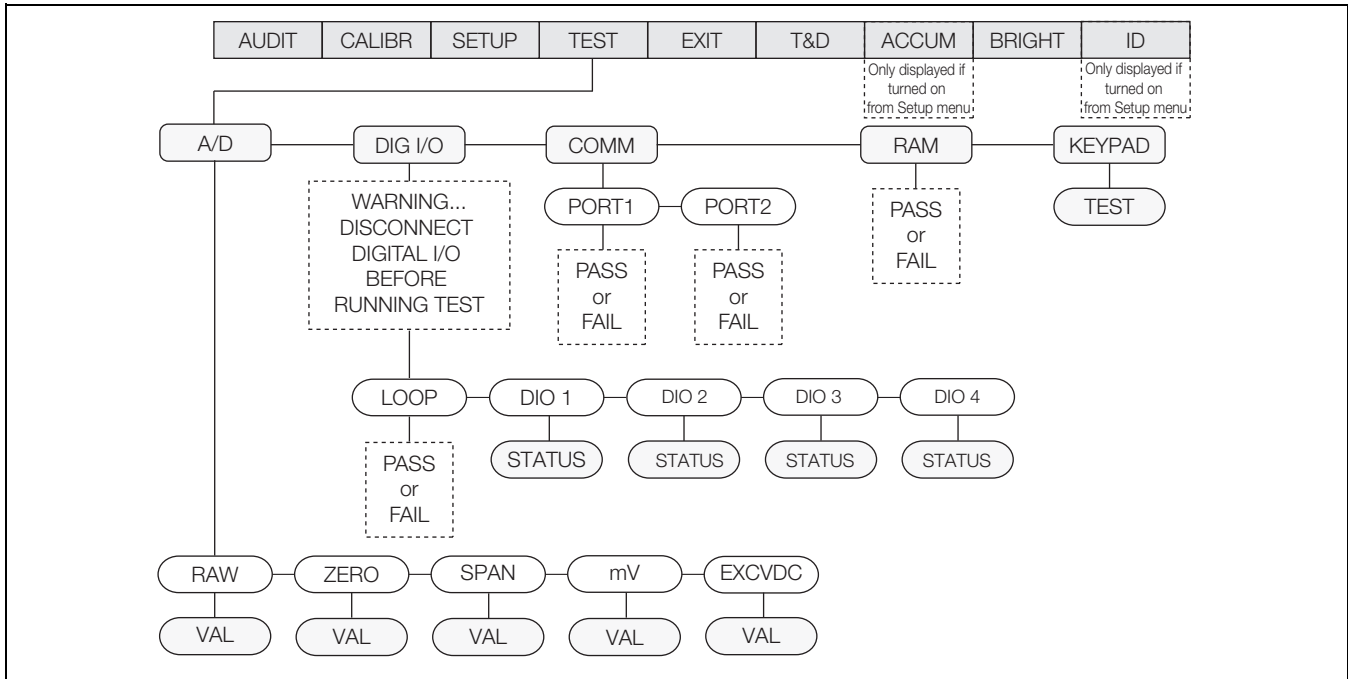

Figure 3-34. Test Menu

Parameter	Choices	Description
A/D	RAW ZERO SPAN mV EXCVDC	Gives details of current or live A/D counts as well as stored zero and span A/D values; Shows voltage levels for signal and excitation voltages (Table 3.5.1 on page 42)
DIG I/O	LOOP DIO 1 DIO 2 DIO 3 DIO 4	Tests your digital I/O ports; if correctly functioning, PASS is displayed; If not functioning, FAIL is displayed (Table 3.5.2 on page 42) NOTE: Digital I/O are active low. Digital I/O go to a ground state to create a short when active.  WARNING The I/O ports become activated when the test is performed. Ensure all equipment is disconnected prior to performing this test to avoid it being activated.
COMM	PORT1 PORT2	Performs a loopback test on the serial ports; If they are functioning, PASS displays; If they are not functioning, FAIL displays (Table 3.5.3 on page 43)
RAM	TEST	Tests the unit's memory; If it is functioning, PASS displays; If it is not functioning, FAIL displays
KEYPAD	TEST	Tests the unit's individual keypad buttons by displaying the name of the key pressed; If nothing displays, the key is not functioning; Press the MENU key to exit the test

Table 3-26. Test Menu Parameters

3.5.1 A/D Menu

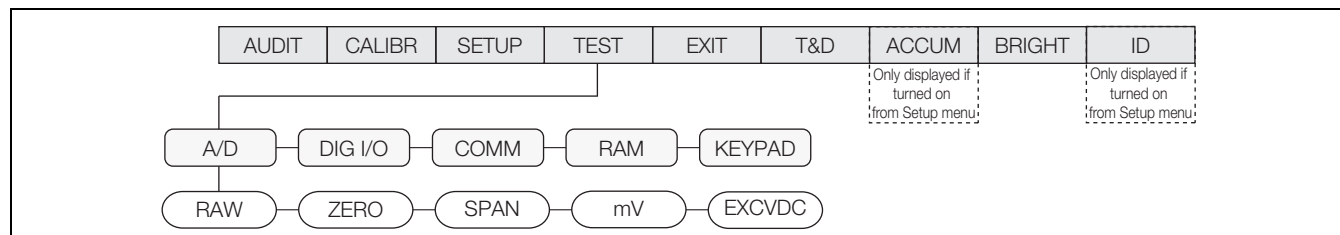

Figure 3-35. A/D Menu

Parameter	Choices	Description
RAW	VAL	Displays the live current raw A/D count
ZERO	VAL	Displays the captured A/D Zero calibration value
SPAN	VAL	Displays the captured A/D Span calibration value
mV	VAL	Displays the live current millivolt signal voltage
EXCVDC	VAL	Displays the current excitation voltage

Table 3-27. A/D Menu Parameters

3.5.2 DIG I/O Menu

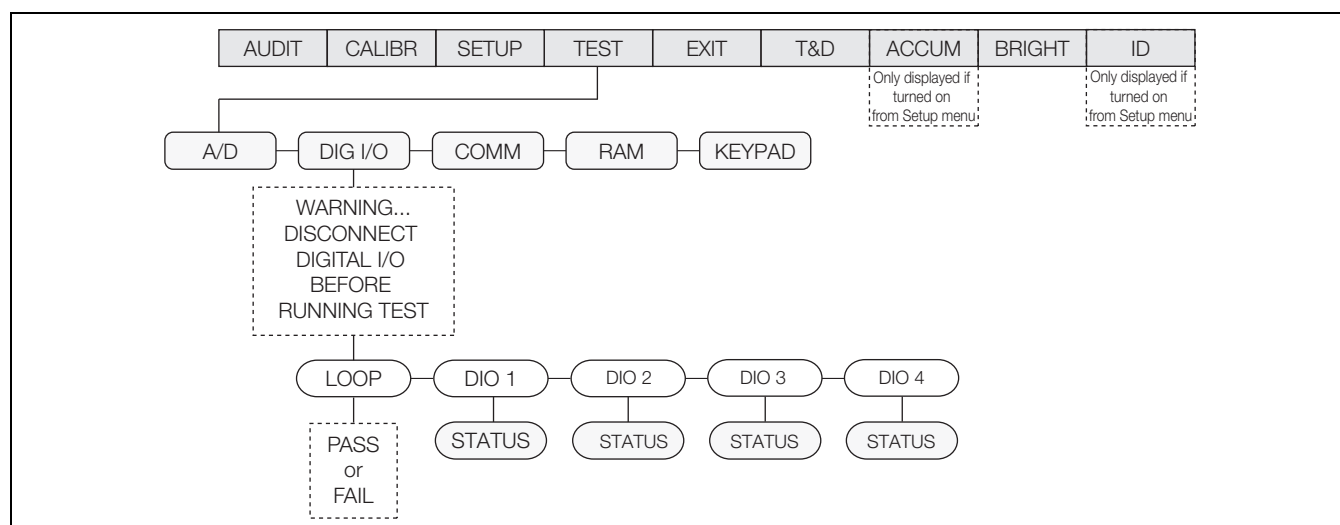

Figure 3-36. Digital Input/Output Menu

Parameter	Choices	Description
LOOP	TEST	Performs a loop test on dig I/O cards
DIO 1 DIO 2 DIO 3 DIO 4	STATUS	Displays the status of each individual digital I/O port; If set as input, the display shows input stats IN HI or IN LO; If set as output, press the ENTER key to toggle the output between HI and LO; OUT HI or OUT LO; OUT LO is active
PORT1 PORT2	TEST	Performs a loopback test on serial port 1 or 2; Connect jumper TX and RX together on port 1 or port 2 before testing

Table 3-28. Digital Input/Output Menu Parameters

3.5.3 COMM Menu

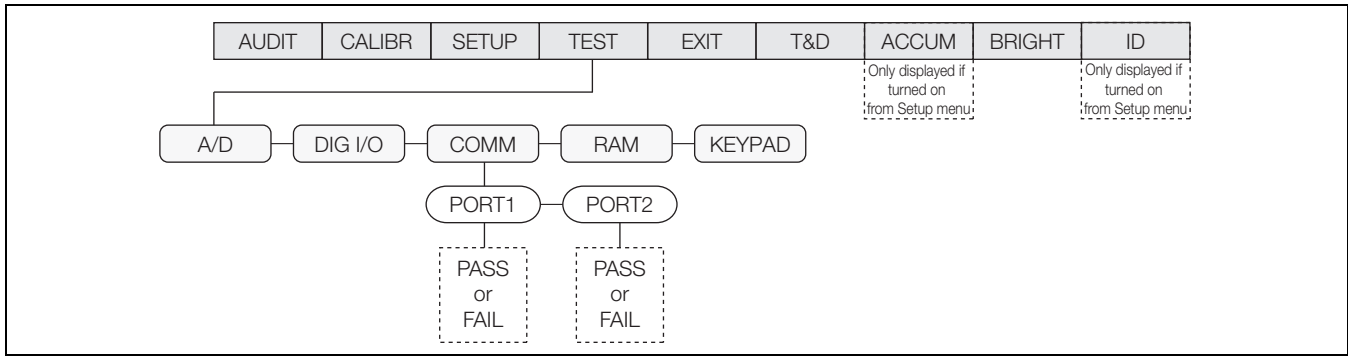

Figure 3-37. Communication Menu

Parameter	Choices	Description
PORT1 PORT2	TEST	Performs a loopback test on serial port 1 or 2; Connect jumper TX and RX together on port 1 or port 2 before testing

Table 3-29. Communication Menu Parameters

3.6 Time and Date Menu

The time and date menu allow for the time and date of the unit to be set.

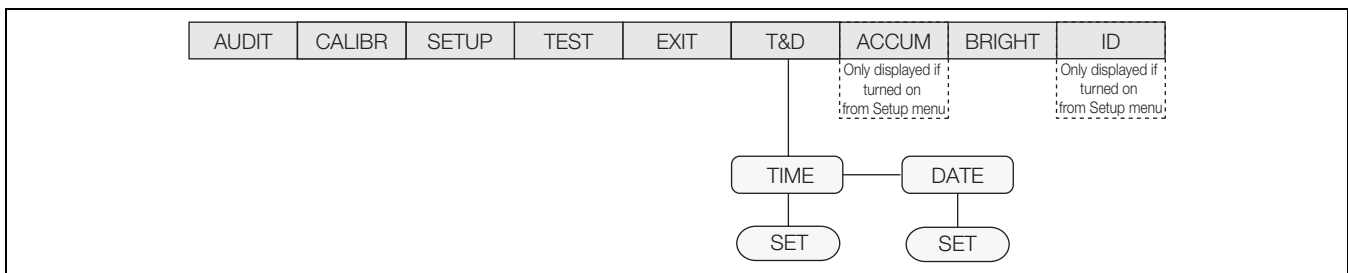

Figure 3-38. Time and Date Menu

3.7 ACCUM Menu

For the **ACCUM** menu to appear, **ON** must be selected from the **SETUP » CONFIG » SCALE » ACCUM** parameter (Figure 3-6 on page 20).

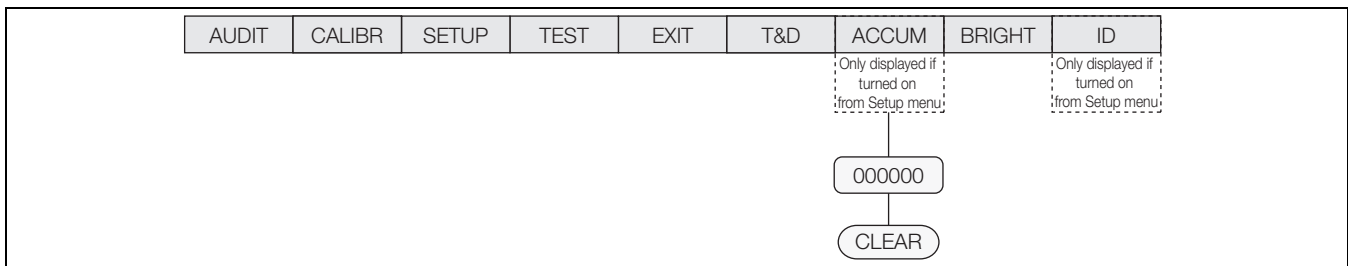

Figure 3-39. Accumulator Menu

3.8 BRIGHT Menu

There are eight brightness settings (0-7) on the CW-90/90X. If a number greater than 7 is selected, **RANGE** displays because the number is out of range.

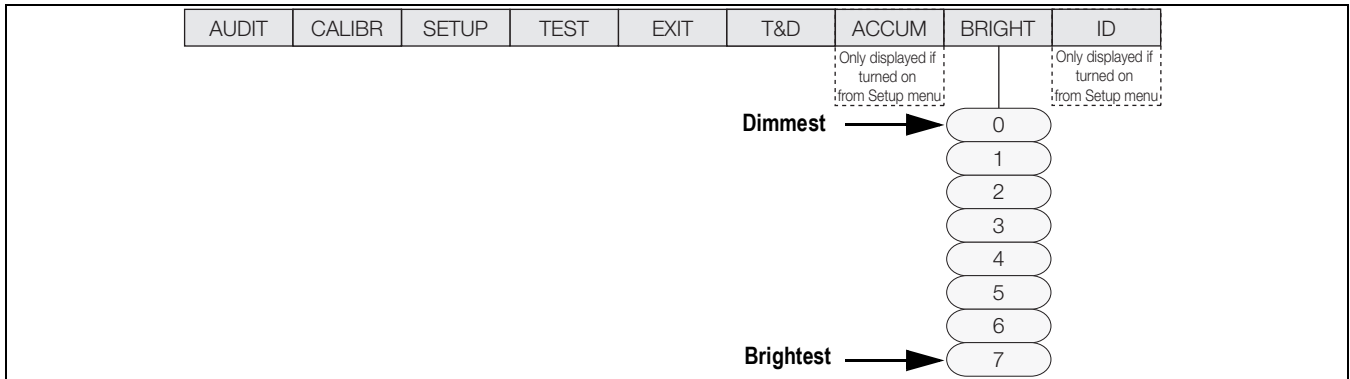

Figure 3-40. Brightness Menu

3.9 ID Menu

For the **ID** menu to appear, **ON** must be selected from the **SETUP » CONFIG » FEATUR » CHKWGH » ID** menu (Figure 3-13 on page 26).

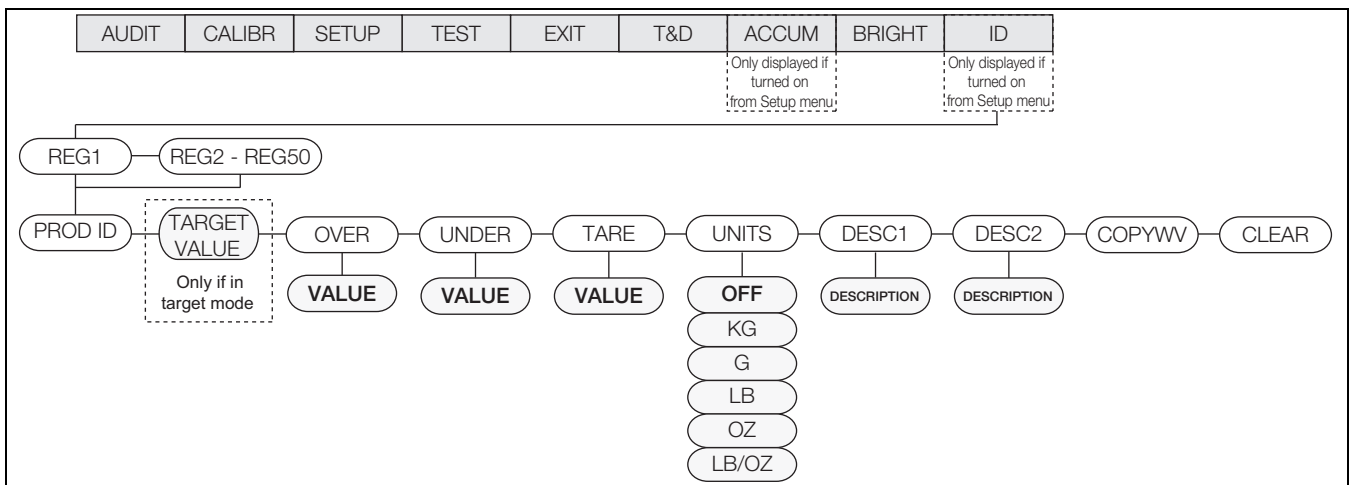

Figure 3-41. ID Menu

Parameter	Choices	Description
REG 1-50	PROD ID	Sets the product ID number
	TARGET (VALUE)	TARGET value recalled with the ID
	OVER (VALUE)	OVER value recalled with the ID
	UNDER (VALUE)	UNDER value recalled with the ID
	TARE (VALUE)	TARE value recalled with the ID
	UNITS	UNITS selects the unit of measure for the stored ID values
	DESCR1 (DESCRIPTION)	DESCR1 description recalled with the ID
	DESCR2 (DESCRIPTION)	DESCR2 description recalled with the ID
	COPYWV	COPYWV copies the working values of Target, Over, Under, Tare, Units, Description 1 and 2 into the ID register. This will overwrite the existing data in the ID register. NOTE: Navigating down (or pressing Enter) at this menu item will activate its function immediately; take care not to select this item unintentionally.
	CLEAR	CLEAR clears all values and descriptions in the ID register. NOTE: Navigating down (or pressing Enter) at this menu item will activate its function immediately; take care not to select this item unintentionally.

Table 3-30. ID Menu Parameters

4.0 Calibration

The CW-90/90X can be calibrated using the front panel, EDP commands, or Revolution.

Front panel calibration can be accessed in two places in the menu:

- CALIBR menu shown in [Figure 4-1](#), quick access calibration
- SCALE submenu shown in [Figure 3-5 on page 19](#), more in-depth scale setup and calibration

The CW-90/90X requires the WZERO and WSPAN points to be calibrated. The linearity points are optional, but must NOT duplicate zero or span. During calibration,  is used for data entry confirmation. It also acts as an **EXECUTE** key, and accepts the value if calibration was successful.

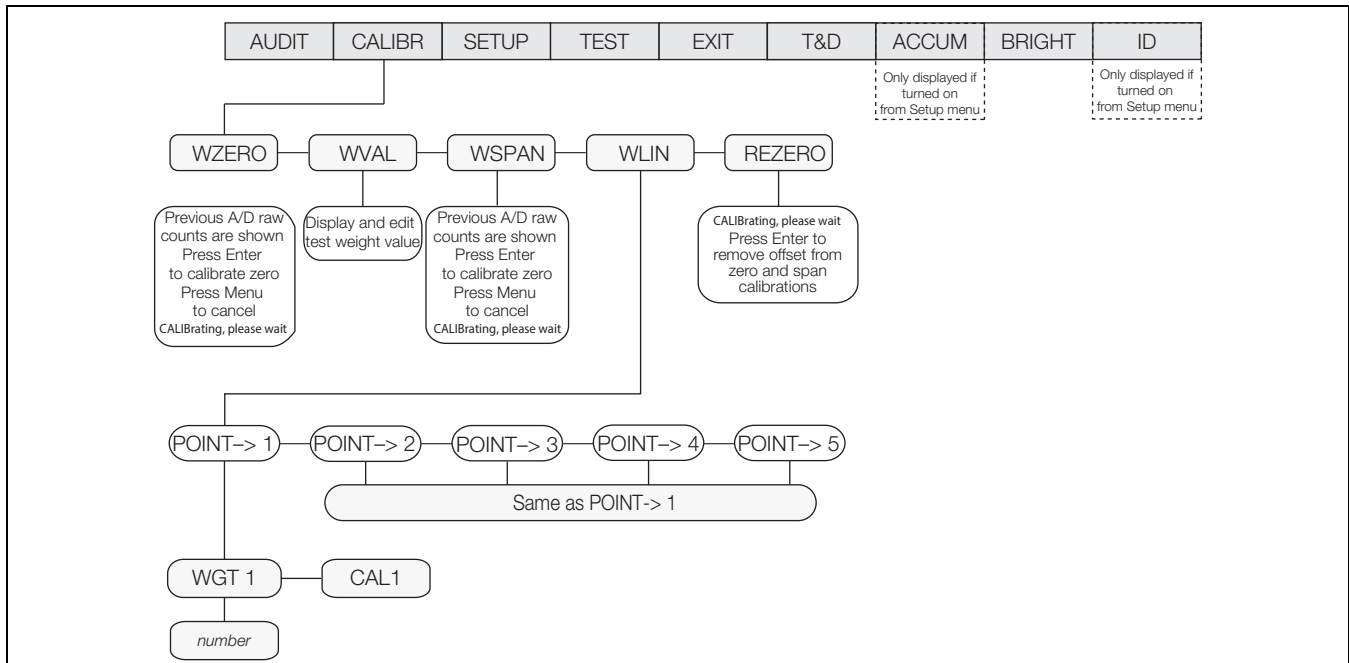









Figure 4-1. Calibration Menu

Calibration consists of the following steps:





- Zero calibration
- Entering the test weight value
- Span calibration
- Optional five-point linearization
- Optional rezero calibration for test weights using hooks or chains

4.1 Front Panel Calibration

1. Press , then press  to navigate to **CALIBR**.
2. Press  or  to go to the **WZERO** parameter.
3. Press  or  to view the A/D count.
4. Press  to Calibrate **WZERO**. **CALIBRATING, PLEASE WAIT** displays. When complete **WVAL** displays.





Note To view the new A/D count, repeat [Step 3](#), but press  instead of  while viewing the value.

5. Press , the stored calibration weight displays.
6. Enter the value of the test weights used for the span calibration ([Section 3.3 on page 18](#)).
7. Press  to store the value. **WSPAN** displays.
8. Press  or  to view the **A/D** count.
9. Place test weights on the scale equal to the **WVAL** value.
10. Press  to calibrate **WSPAN**. **CALIBRATING, PLEASE WAIT** displays. When complete **WLIN** displays.



Note Press  at anytime to exit without saving.

To view the new A/D count, navigate back to the **WSPAN** and repeat [Step 6](#); however, instead of pressing  while viewing the value, press  to exit.

4.1.1 Five-Point Linearization

Five-point linearization (using the **WLIN** parameter) provides increased scale accuracy by calibrating the indicator at up to five additional points between the zero and span calibrations. Linearization is optional: if not performing linearization, skip the **WLIN** parameter. If linearization values have previously been entered, these values are reset to zero during calibration.

Note *The linearity points must be less than the WSPAN point.*

1. With **WLIN** displayed, press  to go to the first linearization point (**PT-> 1**).

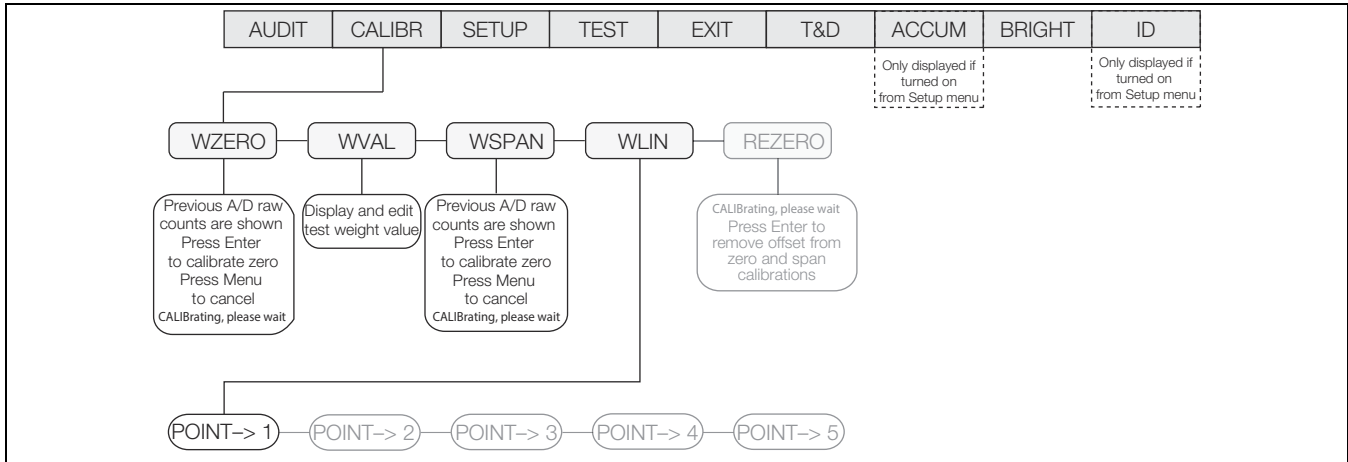





Figure 4-2. Linearization Menu

2. Place test weights on the scale and press .
3. Enter the actual test weight value. Press  to calibrate. **WLIN** displays.
4. Press  to calibrate. **Calibrating, Please Wait** displays. When complete, the A/D count for the linear calibration displays.

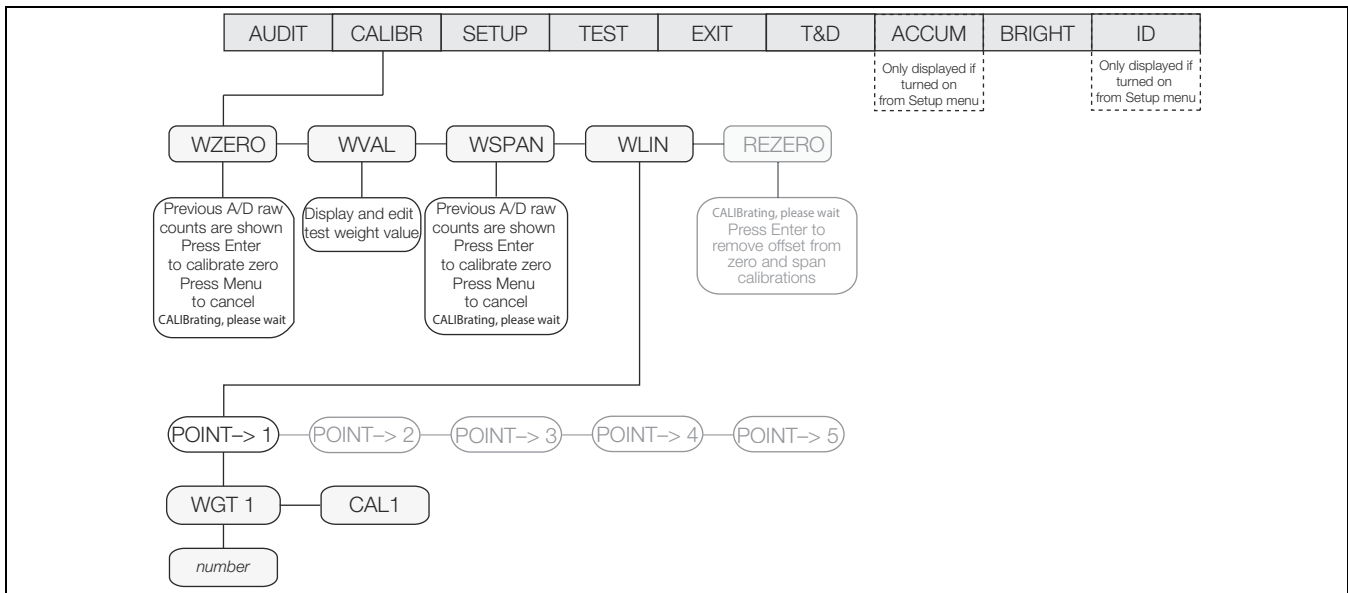



Figure 4-3. Linearization Point Menu

5. Press  to advance to **PT-> 2**.
6. Repeat for up to five linearization points.
7. To exit the linearization parameters, press  to return to **WLIN**.

4.1.2 Rezero

The rezero function is used to remove a calibration offset when hooks or chains are used to hang the test weights.



If no other apparatus was used to hang the test weights during calibration, remove the test weights and press  to return to the CALIBR menu.

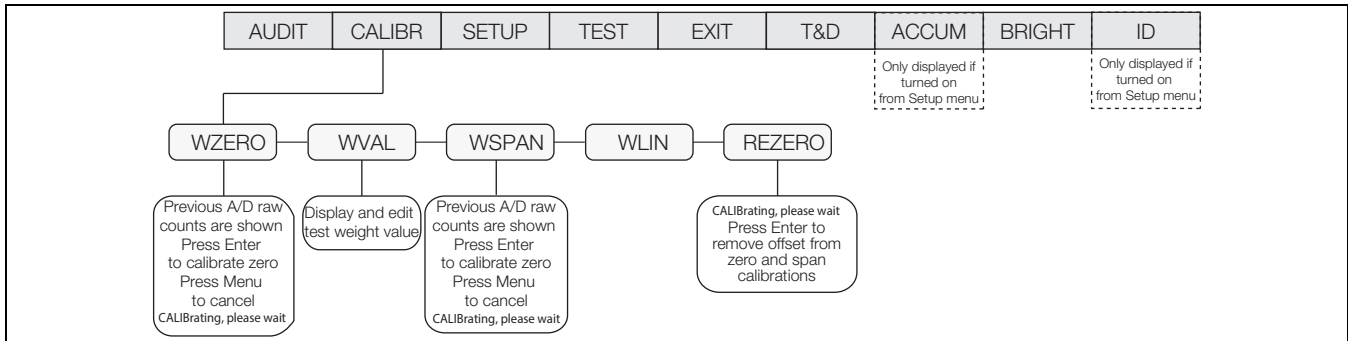









Figure 4-4. Rezero Menu

1. With **REZERO** displayed, press  or  to access the rezero function.
2. If hooks or chains were used during calibration, remove these and the test weights from the scale. Press  until **REZERO** displays.
3. With all weight removed, press  to rezero the scale. This function adjusts the zero and span calibration values. **CALIBRATING, Please Wait** displays. When complete, the adjusted **A/D** count for the zero calibration is displayed.
4. Press , then press  to return to the **CALIBR** menu.
5. Press  or  to return to weigh mode.

4.2 EDP Command Calibration

To calibrate the indicator using EDP commands, the indicator EDP port must be connected to a terminal or personal computer. See [Section 2.6.2 on page 8](#) for EDP port pin assignments.

Once the indicator is connected to the sending device, do the following:

1. Place the indicator in configuration mode (display must read **CONFIG**, see [Figure 3-5 on page 19](#)) and remove all weight from the scale platform.
2. If the test weights require hooks or chains, place the hooks or chains on the scale for zero calibration.
3. Send the SC.WZERO command to calibrate zero. The indicator displays **CALIBRATING, PLEASE WAIT** while calibration is in progress.
4. Place test weights on the scale and use the SC.WVAL command to enter the test weight value in the following format:
SC.WVAL=nnnnnn<CR>
5. Send the SC.WSPAN command to calibrate span. The indicator displays **CALIBRATING, PLEASE WAIT** while calibration is in progress.
6. Up to five linearization points can be calibrated between the zero and span calibration values. Use the following commands to set and calibrate a single linearization point:
SC.WLIN.V1=nnnnn<CR>
SC.WLIN.C1<CR>
The SC.WLIN.V1 command sets the test weight value (nnnnn) for linearization point 1. The SC.WLIN.C1 command calibrates the point. Repeat using the SC.WLIN.Vx and SC.WLIN.Cx commands as required for additional linearization points.
7. To remove an offset value, clear all weight from the scale, including hooks or chains used to hang test weights, then send the SC.REZERO command. The indicator displays **CALIBRATING, PLEASE WAIT** while the zero and span calibrations are adjusted.
8. Send the SC.KUPARROW or SC.KEXIT EDP command to return to normal mode.

4.3 Revolution Calibration

To calibrate the indicator using Revolution, the indicator EDP port must be connected to a PC running the Revolution configuration utility.

1. Place the indicator in configuration mode (display reads **CONFIG**, see [Figure 3-5 on page 19](#)) and remove all weight from the scale platform.
2. From Revolution, select **File » New**. The **Select Indicator** dialog box displays.
3. Select CW-90 and click **OK**.
4. From the **Communications** menu, select **Connect**.
5. From the left pane, expand the **Scale** selection and select .

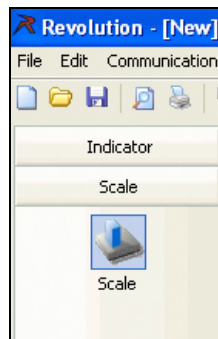

Figure 4-5. Scale Button



6. From the **Tools** menu, select **Calibration Wizard**.
7. Click **NEXT** to begin the Calibration Wizard.
8. Select whether to perform a standard calibration or a standard with multi-point linearization and click **NEXT**.
9. In the text box, enter the test weight value to be used for span calibration.
10. Select the check box if using chains or hooks during the calibration, then click **NEXT**.
11. Remove all weight from the scale and select **Click to Calibrate Zero** to begin zero calibration. If test weights require hooks or chains, place them on the scale for zero calibration.
12. When zero calibration is complete, the Calibration Wizard prompts to place test weights on the scale. Place the test weights on the scale, then select **Click to Calibrate Span**.
13. If performing linear calibration, the Calibration Wizard now displays prompts (1–5). Enter the weight value for Linear Point #1, place test weights on scale and click **GO**. Repeat for additional linearization points, then click **NEXT**.
14. The new and old calibration settings are displayed. To accept the new values, click **Finish**. To exit and restore the old values, select **Cancel**.

4.3.1 More About Calibration

The following topics provide additional information about compensating for environmental factors and diagnostic information for determining expected zero and span coefficients.

Adjusting Final Calibration

Calibration may be affected by environmental factors including wind, vibration, and angular loading. For example, if the scale is calibrated with 1000 lb, a strain test may determine that at 2000 lb the calibration is 3 lb high. In this case, final calibration can be adjusted by tweaking **WVAL** to 998.5 lb. This adjustment provides a linear correction of 1.5 lb per 1000 lb.

To adjust the final calibration, return to the **WVAL** prompt and press  to show the test weight value. Press Δ or ∇ to adjust calibration up or down. Press  to save the value, then press Δ to return to the **CALIBR** menu.

5.0 Operation

The CW-90/90X can be configured for one of the three modes of operation: range, target weight, and target percent. Selecting the operation mode is done under the **CHKWGH** menu, **MODE** sub-menu.

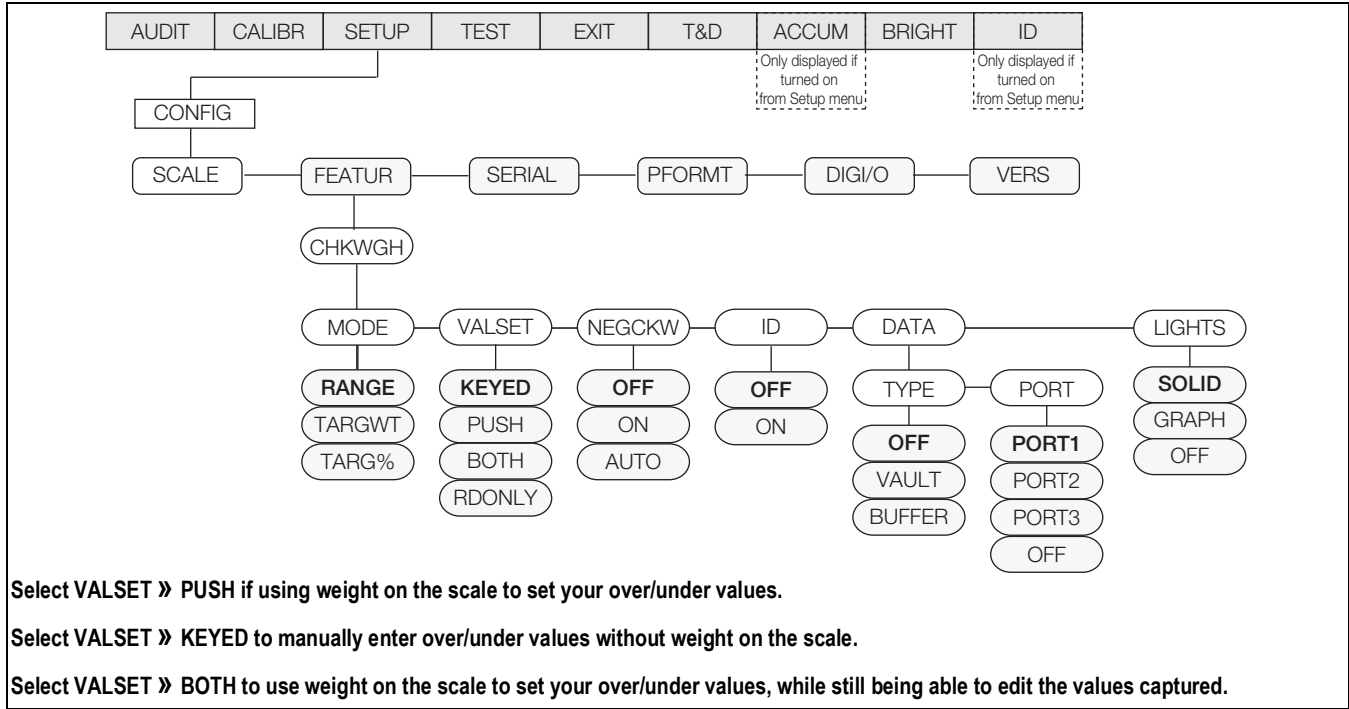

Figure 5-1. CHKWGH Menu



Note The CW-90 displays center dashes while in the warm up mode.

5.1 Range Mode

In **Range** mode, the **OVER** and **UNDER** values must be set. **ACCEPT** band is determined as the gap between the settings.

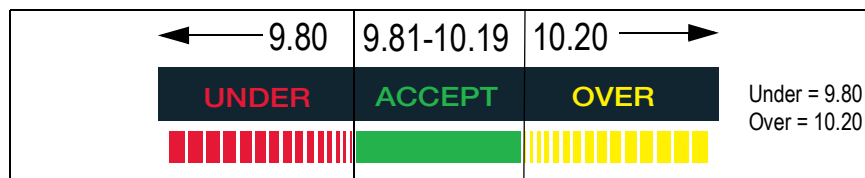

Figure 5-2. Accept Band Determined by Under/Over Settings in Range Mode

5.1.1 Value Set: Keyed

To manually set the **OVER/UNDER** values with no weight on the scale:

1. Press . The **OVER** light begins flashing and the value with flashing digit is shown.
2. Enter the desired over value by using the and keys to increment/decrement the values and or to move between digits. If using the CW-90, the numeric keypad can be used to enter the desired under value.



Note To discard any changes and return to weigh mode, press .

3. When the desired value is displayed, press . The decimal point flashes.
4. To change the position of the decimal point, use and until it is in the desired position.
5. Press again to accept the value and return to weigh mode.
6. Press . The **UNDER** light begins flashing and the value with a flashing digit displays.
7. Using and to increment/decrement the values and or to move between digits, enter the desired under value. If using the CW-90, the numeric keypad can be used to enter the desired under value.



Note To discard any changes and return to weigh mode, press .

8. When the desired value is displayed, press . The decimal point flashes.
9. To change the position of the decimal point, use or until it is in the desired position.
10. Press to accept the value and return to weigh mode.

5.1.2 Value Set: Push

To set the **OVER/UNDER** values using weight on the scale:

1. Place the weight to be determined as over on the scale.
2. Press . The weight is captured and set as the Over value. **Stored** displays and the **OVER** light flashes.
3. Place the weight to be determined as under on the scale.
4. Press . The weight is captured and set as the Under value. **Stored** displays and the **UNDER** light flashes.
5. The **ACCEPT** band is set as the gap between the **OVER** and **UNDER** settings.

5.2 Target Weight Mode

In Target Weight mode, the over and under values can only be set by keying in the values. The **VALSET** parameter only pertains to setting the target weight value. The **ACCEPT** band is determined based on a desired target weight.

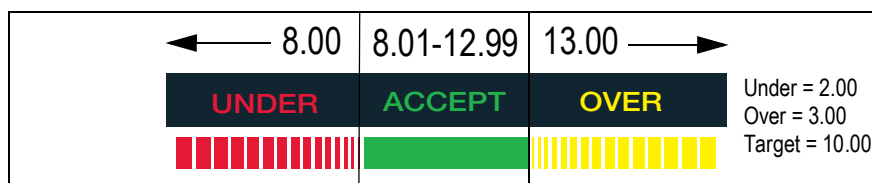















Figure 5-3. Example of Under/Over/Target Settings in Target Weight Mode

5.2.1 Value Set: Keyed

1. Press . The Accept light begins flashing and a flashing digit displays.
2. Using  and  to increment/decrement the values and  or  to move between digits, enter the desired value. If using the CW-90, the numeric keypad can be used to enter the desired under value.











Note To discard any changes and return to weigh mode, press .

3. When the desired value is displayed, press . The decimal point flashes.
4. To change the position of the decimal point, use  or  until it is in the desired position.
5. Press  to accept the value and return to weigh mode.
6. Press . The **OVER** light begins flashing and a flashing digit displays.
7. Using  and  to increment/decrement the values and  or  to move between digits, enter the desired value. If using the CW-90, the numeric keypad can be used to enter the desired under value.







Note To discard any changes and return to weigh mode, press .







8. When the desired value is displayed, press . The decimal point flashes.
9. To change the position of the decimal point, use the  and  keys until it is in the desired position.
10. Press  to accept the value and return to weigh mode.
11. Press . The **UNDER** light begins flashing and a flashing digit displays.
12. Using  and  to increment/decrement the values and  or  to move between digits, enter the desired value. If using the CW-90, the numeric keypad can be used to enter the desired under value.



Note To discard any changes and return to weigh mode, press .

13. When the desired value is displayed, press . The decimal point flashes.
14. To change the position of the decimal point, use  or  until it is in the desired position.
15. Press  to accept the value and return to weigh mode.

5.2.2 Value Set: Push

1. Place the weight to be used as the target on the scale.
2. Press . The accept light flashes and **STORED** displays. The weight is captured and stored as the target weight.
3. Press . The **OVER** light begins flashing and a flashing digit displays.
4. Using  and  to increment/decrement the values and  or  to move between digits, enter the desired value. If using the CW-90, the numeric keypad can be used to enter the desired under value.



Note To discard any changes and return to weigh mode, press .

5. When the desired value is displayed, press **ENTER**. The decimal point flashes.
6. To change the position of the decimal point, use **ID** or **TARGET** to set the desired position.
7. Press **ENTER** to accept the value and return to weigh mode.
8. Press **UNDER**. The **UNDER** light begins flashing and a flashing digit displays.
9. Using **OVER** and **UNDER** to increment/decrement the values and **ID** or **TARGET** to move between digits, enter the desired value. If using the CW-90, the numeric keypad can be used to enter the desired under value.



Note To discard any changes and return to weigh mode, press **MENU**.

10. When the desired value is displayed, press **ENTER**. The decimal point flashes.
11. To change the position of the decimal point, use **ID** or **TARGET** to set the desired position.
12. Press **ENTER** to accept the value and return to weigh mode.

5.3 Target Percent Mode

In Target Percent mode, the **OVER** and **UNDER** values can only be set by keying in the values (in percentages). The **VALSET** parameter only pertains to setting the target weight value. The **ACCEPT** band is determined based on a percentage of the desired target weight.



Note The % annunciator is lit during target percent setup in menu mode, but not in weigh mode.

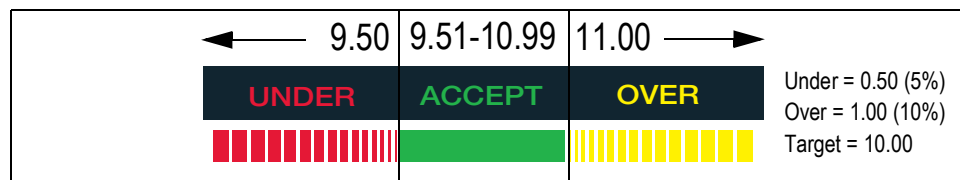

Figure 5-4. Example of Under/Over/Target Settings in Target Percent Mode

5.3.1 Value Set: Keyed

1. Press **TARGET**. The accept light begins flashing and a flashing digit displays.
2. Using **OVER** and **UNDER** to increment/decrement the values and **ID** or **TARGET** to move between digits, enter the desired value. If using the CW-90, the numeric keypad can be used to enter the desired under value.





Note To discard any changes and return to weigh mode, press **MENU**.

3. When the desired value is displayed, press **ENTER**. The decimal point flashes.
4. To change the position of the decimal point, use **ID** or **TARGET** to set the desired position.
5. Press **ENTER** to accept the value and return to weigh mode.
6. Press the **OVER** key. The **OVER** light begins flashing and a flashing digit is shown.

- Using the Δ and ∇ keys to increment/decrement the values and the \triangleleft and \triangleright keys to move between digits, enter the desired value, in percent (entering **10** equals 10%). If using the CW-90, you can also use the numeric keypad to enter the desired over value.





Note To discard any changes and return to weigh mode, press .

- When the desired value is displayed, press . The decimal point flashes.
- To change the position of the decimal point, use the \triangleleft and \triangleright keys until it is in the desired position.
- Press  again to accept the value and return to weigh mode.
- Press . The **UNDER** light begins flashing and a flashing digit is shown.
- Using the Δ and ∇ keys to increment/decrement the values and the \triangleleft and \triangleright keys to move between digits, enter the desired value, in percent (entering **5** equals 5%). If using the CW-90, you can also use the numeric keypad to enter the desired *under* value.



Note To discard any changes and return to weigh mode, press .



- When the desired value is displayed, press . The decimal point flashes.
- To change the position of the decimal point, use the \triangleleft and \triangleright keys until it is in the desired position.
- Press  again to accept the value and return to weigh mode.

5.3.2 Value Set: Push

- Place the weight you want to be used as the “target percent” value on the scale.
- Press . The Accept light flashes and the indicator displays STORED. The weight has been captured and stored as the target percent value.
- Press the **OVER** key. The **OVER** light begins flashing and a flashing digit is shown.
- Using the Δ and ∇ keys to increment/decrement the values and the \triangleleft and \triangleright keys to move between digits, enter the desired value, in percent (entering **10** equals 10%). If using the CW-90, you can also use the numeric keypad to enter the desired *over* value.





Note To discard any changes and return to weigh mode, press .

- When the desired value is displayed, press . The decimal point flashes.
- To change the position of the decimal point, use the \triangleleft and \triangleright keys until it is in the desired position.
- Press  again to accept the value and return to weigh mode.
- Press . The **UNDER** light begins flashing and a flashing digit is shown.
- Using the Δ and ∇ keys to increment/decrement the values and the \triangleleft and \triangleright keys to move between digits, enter the desired value, in percent (entering **5** equals 5%). If using the CW-90, you can also use the numeric keypad to enter the desired *under* value.



Note To discard any changes and return to weigh mode, press .

- When the desired value is displayed, press . The decimal point flashes.
- To change the position of the decimal point, use the \triangleleft and \triangleright keys until it is in the desired position.
- Press  again to accept the value and return to weigh mode.

5.4 IDs

IDs are used to save and recall previously set over/under/tare settings, descriptions, and units preferences. The CW-90/90X has the capacity to store up to 50 individual IDs. Make sure you have IDs enabled under the **CHKWGH** menu shown in [Figure 5-1 on page 50](#) or the menu will not appear. To store more than 50 IDs, WeighVault and an Ethernet option card are required.



Note To clear over/under/tare settings, set the ID number to 0.

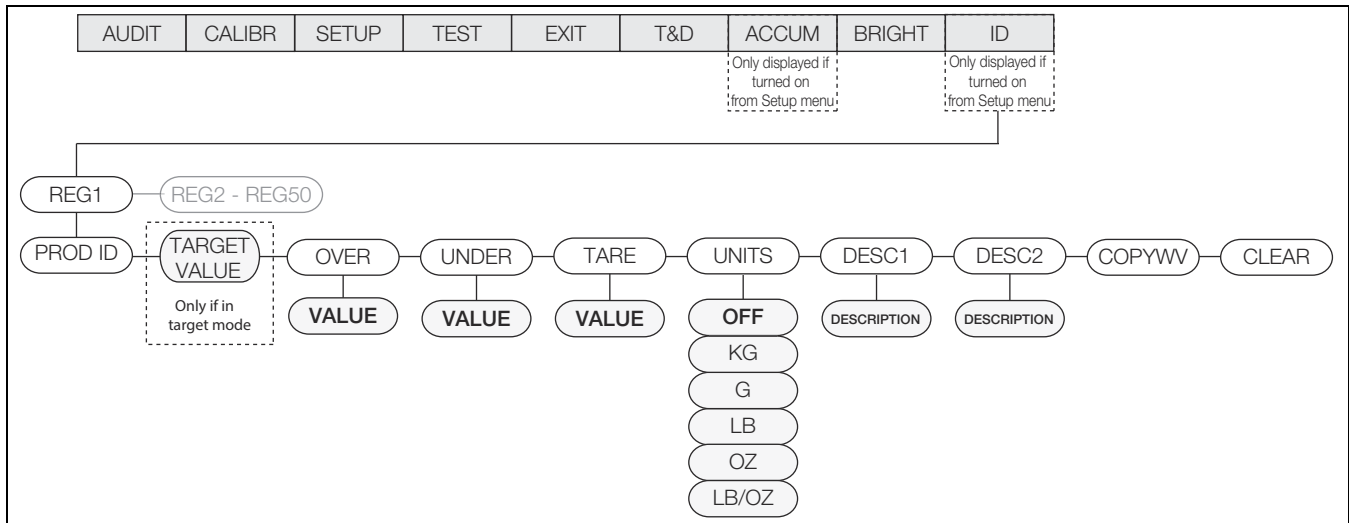

Figure 5-5. ID Menu

5.4.1 Setting an ID

1. From the **ID** menu, press and you will be at **REG1**.
2. Navigate to the REG number you want to use (1-50) by using the Δ and ∇ keys.



Note All menus have wrap-around functionality. If you are at **REG1** and want to access **REG50**, you can quickly do so by moving backwards through the menu.

3. When you have reached the REG number you want to set, press to select that REG.
4. Press ∇ or to select **PROD ID**.
5. Use the Δ and ∇ keys to set the PROD ID and press .
6. If in Target mode, **TARGET** displays. If mode is not set to **Target**, skip to [Step 10 on page 56](#). If you do not need to adjust the value, use the \triangleleft and \triangleright keys to move to the next parameter. To adjust the value, press and use the Δ and ∇ keys to increment/decrement the values and the \triangleleft and \triangleright keys to move between digits. If using the CW-90, you can also use the numeric keypad to enter the desired value.





Note To discard any changes and return to weigh mode, press .

7. When the desired value is displayed, press . The decimal point flashes.
8. To change the position of the decimal point, use the \triangleleft and \triangleright keys until it is in the desired position.
9. Press again to accept the value.

10. **OVER** is displayed. If you do not need to adjust the value, use the ◀ and ▶ keys to move to the next parameter. To adjust the value, press  and use the ▲ and ▼ keys to increment/decrement the values and the ◀ and ▶ keys to move between digits. If using the CW-90, you can also use the numeric keypad to enter the desired value.





Note To discard any changes and return to weigh mode, press .

11. When the desired value is displayed, press . The decimal point flashes.
12. To change the position of the decimal point, use the ◀ and ▶ keys until it is in the desired position.
13. Press  again to accept the value.
14. **UNDER** displays. Press  and use the ▲ and ▼ keys to increment/decrement the values and the ◀ and ▶ keys to move between digits. If using the CW-90, you can also use the numeric keypad to enter the desired value.









Note To discard any changes and return to weigh mode, press .

15. When the desired value is displayed, press . The decimal point flashes.
16. To change the position of the decimal point, use the ◀ and ▶ keys until it is in the desired position.
17. Press  again to accept the value.
18. **TARE** displays. Press  and use the ▲ and ▼ keys to increment/decrement the values and the ◀ and ▶ keys to move between digits. If using the CW-90, you can also use the numeric keypad to enter the desired value.





Note If a tare value is not entered, press ▶ to move to the next parameter.

To discard any changes and return to weigh mode, press .

19. When the desired value is displayed, press . The decimal point flashes.
20. To change the position of the decimal point, use the ◀ and ▶ keys until it is in the desired position.
21. Press  again to accept the value.
22. **UNITS** displays. Press  and use the ◀ and ▶ keys to move between units (LB, OZ, LB/OZ, OFF, KG, G).
23. When the desired unit is displayed, press .
24. **DESC1** displays. If the value does not need adjustment, use the ◀ and ▶ keys to move to the next parameter. To adjust the value, press  to create an ID description.
25. Use the ▲ and ▼ keys to increment/decrement description entry characters and the ◀ and ▶ keys to move between placeholders.
26. When the desired description is displayed, press the  key to accept.



Note To discard any changes and return to weigh mode, press .

27. **DESC2** displays. If you do not need to adjust the value, use the ◀ and ▶ keys to move to the next parameter. To adjust the value, press  to create a secondary ID description. A flashing placeholder is displayed.
28. Use the ▲ and ▼ keys to increment/decrement description entry characters and the ◀ and ▶ keys to move between placeholders.
29. When the desired description is displayed, press  to accept.



Note To discard any changes and return to weigh mode, press .

30. **COPYWV** displays. This feature copies the current over/under/tare values, units, description 1 and description 2 being used in normal weighing mode and saves them into the current ID number. Press  to copy the current values into the ID. The indicator displays **SAVING** and return to **COPYWV** when complete.
 - To prevent copy the working values into this ID, use the ◀ and ▶ keys to move to the next parameter

IMPORTANT

Do not select the following: COPYWV or CLEAR unless this is actually the function that you're trying to perform.

COPYWV copies the working values of Target, Over, Under, Tare, Units, Description 1 and 2 into the ID. It will erase all the data that has been entered through the main menu.

CLEAR clears all values and descriptions in the ID.

31. When all parameters have been set, press  to save the changes and return to weigh mode.

5.4.2 Using a Stored ID

1. Press the **ID** key. The last PROD ID used is displayed with the left-most digit flashing.
2. Use the ▲ and ▼ keys to increment/decrement values and the ◀ and ▶ keys to move between digits until the desired PROD ID value is displayed, or use the numeric keypad to enter the desired PROD ID.



Note *If an ID does not have values assigned, NO ID is displayed. The ZERO key acts as a backspace on the CW-90X. Use this key to navigate from a two-digit ID to a one-digit ID. On the CW-90, use the CLR or ZERO key.*

3. Press  to start using the PROD ID. **LOADING** is displayed, as well as the PROD ID number and Description Field 1 (i.e., **LOADING ID1 HAM**). The indicator returns to weigh mode when the PROD ID has been loaded.

5.4.3 WeighVault

WeighVault is a PC program which allows CW-90/90X users to add, edit, and access IDs over a network connection. WeighVault surpasses the CW-90/90X's 50 ID limitation and eliminates front-panel entry of ID parameters. It also collects data as transactions occur, and provides detailed transaction and productivity reports which can be exported to Excel, Word, or PDF. For WeighVault to function, the following criteria must be met:

- Ethernet card (wired or wireless) installed in the CW-90/90X; See the Ethernet TCP/IP Interface Installation and Configuration Manual (PN 72117) or WLAN Installation Instructions (PN 108680) for more information
- PC running the WeighVault service must have a static IP address
- IP address assigned to the CW-90/90X
- WeighVault enabled in the CW-90/90X menu (VAULT parameter (Section 3.4.2 on page 26))
- Port corresponding to the Ethernet card must be selected in the CW-90/90X menu (Section 3.4.2 on page 26)

Once the above criteria have been met, IDs can then be entered into WeighVault and saved on the PC's hard drive.

The **Edit Product** dialog box in Figure 5-6 shows ID parameters which can be saved in WeighVault.

The screenshot shows the 'Edit Product' dialog box with the following fields and values:

- Product ID: 1
- Description 1: Chicken
- Description 2: Thighs
- Units: LB (Note: When LB/OZ is the selected units, all values are entered in ounces.)
- Tare Weight: 0
- Target Value: 2
- Under Value: 1
- Over Value: 3
- Broken Rules: (Empty list)
- Buttons: Save, Cancel

Figure 5-6. WeighVault Edit Product Dialog Box

To access a saved ID from WeighVault over the network connection:

1. Using the CW-90/90X front panel, press the **ID** key.
2. Use the Δ and ∇ keys to select an ID to be loaded.
3. Press **ENTER**.
 - The ID is loaded and ready to use

5.5 Negative Checkweighing

You can use negative checkweighing if you have an item which you want to take weight away from. For example, if a product on the CW-90/90X weighs 20 pounds and you want to remove weight in 2 pound increments, with negative checkweighing enabled, the *Over* value could be set to -3 and the *Under* value could be set to -1. The *Accept* band would therefore be -2, illuminating the green LED when the desired weight is removed from the product.



Negative checkweighing is only operable in Range mode. The Target key is not used. When entering Over/Under values and printing, the negative symbol is not displayed. These numbers are still treated as negative values despite the symbol not being displayed. COM port settings are limited to L-Stab, Demand (only if NEGCKW is set to ON rather than AUTO), and Wait SS.

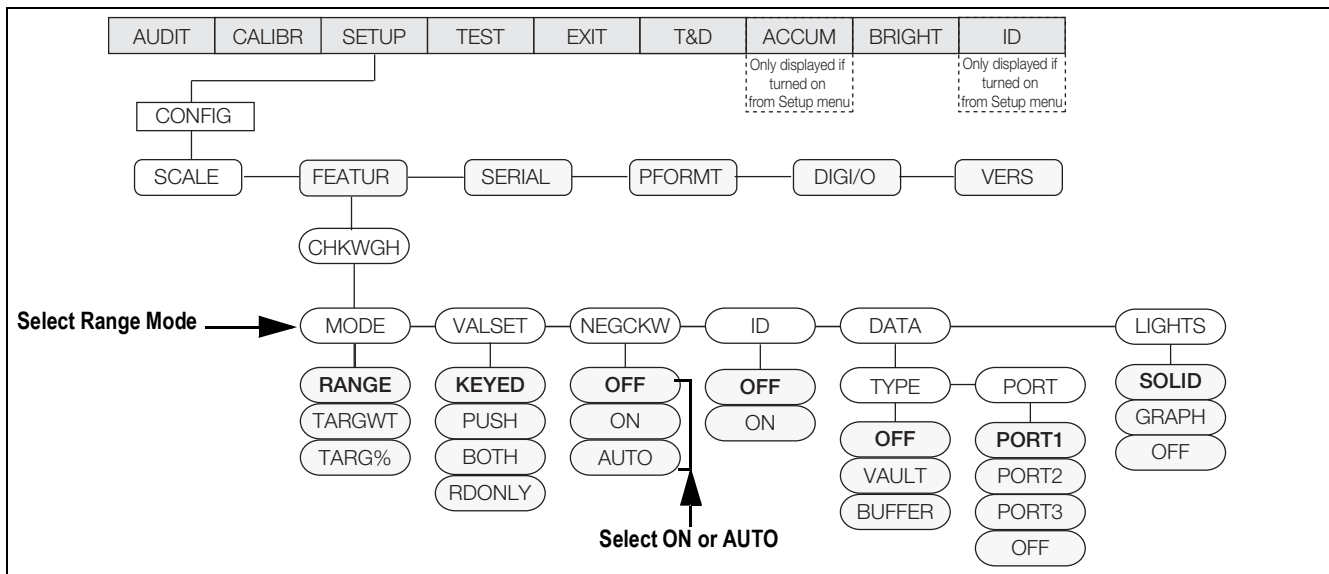

Figure 5-7. CHKWGH Menu

To use negative checkweighing:

1. Ensure **Range** is selected under **Mode**.
2. Under the **NEGCKW** parameter, select **ON** or **AUTO**.



If ON is selected, you have to manually tare when the Accept band is reached. If AUTO is selected, it will automatically tare when the Accept band is reached and is stable.

3. Press the **OVER** key.
4. Using the Δ and ∇ keys to increment/decrement the values and the \triangleleft and \triangleright keys to move between digits, enter the desired over value. If using the CW-90, you can also use the numeric keypad to enter the desired over value.



The Over value you are entering is a negative value. However, it will appear to be a higher number than the Under value on the display because the negative symbol is not displayed. An example of Over/Under negative checkweighing values as they appear on the display would be Over: 3 (actually recorded as -3) and Under: 1 (actually recorded as -1). To discard any changes and return to weigh mode, press .



5. When the desired value is displayed, press . The decimal point flashes.
6. To change the position of the decimal point, use the \triangleleft and \triangleright keys until it is in the desired position.
7. Press again to accept the value and return to weigh mode.
8. Press .

9. Using the \triangle and ∇ keys to increment/decrement the values and the \triangleleft and \triangleright keys to move between digits, enter the desired *under* value. If using the CW-90, you can also use the numeric keypad to enter the desired *under* value.

**Note**

The Under value you are entering is a negative value. However, it will appear to be a lower number than the Over value on the display because the negative symbol is not displayed. An example of Over/Under negative checkweighing values as they appear on the display would be Over: 3 (actually recorded as -3) and Under: 1 (actually recorded -1).

To discard any changes and return to weigh mode, press .

10. When the desired value is displayed, press . The decimal point flashes.
- To change the position of the decimal point, use the \triangleleft and \triangleright keys until it is in the desired position.
11. Press  again to accept the value and return to weigh mode.
12. Place the weight on the scale and press the **TARE** key to begin negative checkweighing.
13. Begin removing product from the scale until the *Accept* band is reached.
14. If **AUTO** was selected in [Step 2 on page 59](#), the weight will be tared automatically. If **ON** was selected, press **TARE** to tare the weight.
15. Repeat [Step 13-Step 14](#) as needed.

6.0 Serial Commands

The CW-90/90X can be controlled by a PC or remote keyboard connected to an indicator serial port. Control is provided by a set of serial commands that can simulate front panel key press functions, display and change setup parameters, and perform reporting functions. This provides the ability to print configuration data or to save to a hard drive.



6.1 The Serial Command Set

The serial command set can be divided into five groups. When a serial command is processed, the CW-90/90X responds with the message **OK** verifying that the command was received and executed. If the command is unrecognized or cannot be executed, the CW-90/90X responds with **??**.

6.1.1 Key Press Commands

Key press serial commands simulate pressing the keys on the front panel of the indicator. These commands can be used in setup and weigh mode. Some of the commands serve as pseudo keys, providing functions that are not represented by a key on the front panel.

To enter a tare weight:

1. Type K# and press  (or RETURN).
2. Type K# (for two digit weights) and press .
3. Type KTARE and press .

Command	Function
KMENU	Press the MENU key
KZERO	In weighing mode, press the ZERO key
KUNITS	In weighing mode, press the UNITS key
KPRINT	In weighing mode, press the PRINT key
KTARE	Press the TARE key
KOVER	Press the OVER key
KUNDER	Press the UNDER key
KID	In weighing mode, press the ID key; In menu mode, move left in the menu; in data entry mode, move to previous digit
KTARGET	Press the TARGET key
KGROSSNET	In weighing mode, press the GROSS/NET key (pseudo key)
KGROSS	Go to gross mode (pseudo key)
KNET	Go to net mode (pseudo key)
KDISPACCUM	Display ACCUM (pseudo key)
KDISPTARE	Display tare (pseudo key)
KCLR	Press the CLEAR key
KCLRCN	Reset consecutive number (pseudo key)
KCLRTAR	Clear tare from system (pseudo key)
KLEFT	In menu mode, move left in the menu
KRIGHT	In menu mode, move right in the menu
KUP	In weighing mode, press the OVER key; in menu mode, move up in the menu; in data entry mode, increment the current digit
KDOWN	In weighing mode, press the UNDER key; in menu mode, move down in the menu; in data entry mode, decrement the current digit
KSAVE	In menu mode, saves the current configuration
KEXIT	In menu mode, saves the current configuration then exits to normal mode
KCLRNV	In menu mode, clears non-volatile RAM
K0-K9	Press number 0 (zero) through 9
KDOT	Press the decimal point (.)
KENTER	Press the ENTER key
KLOCK	Lock specified front panel key; Example: To lock the ZERO key, enter KLOCK=KZERO
KUNLOCK	Unlock specified front panel key; Example: To unlock the PRINT key, enter KUNLOCK=KPRINT
KDATE	Display date (pseudo key)
KTIME	Display time (pseudo key)
KESCAPE	Exits selected parameter; Returns to weigh mode if a parameter is not selected (functions identical to the MENU key in menu mode)

Table 6-1. Serial Key Press Commands

6.1.2 ID Commands

Command	Function
ID.PRODID#n	(4 numeric digits max.)
ID.DESC1#n	(32 characters max.)
ID.DESC2#n	(32 characters max.)
ID.OVER#n	(weight value)
ID.UNDER#n	(weight value)
ID.TARE#n	(weight value)
ID.TARGET#n	(weight value)
ID.UNITS#n	(same in alternate units)
ID.SELECT#n	Selects (loads) the ID stored in register "n" into the working register
ID.CLEAR#n	Clears the values from ID register "n"
ID.CLRALL	Clears all IDs (only if in menu mode)
ID.COPYWV#n	Copies (stores) the working ID values into register "n"
ID.SELECT=XX	Selects (loads) the stored ID that has a Product ID of XX into the working register. If Product ID "XX" is not found, the response will be "??"
ID.FINDPROD=XX	Returns the ID register number where Product ID "XX" is located. If Product ID "XX" is not found, the response will be "??"
For commands ending with #n, n is the ID storage register number, 0-50. Register number 0 is the "working" ID register. Numbers 1-50 are the stored ID registers.	

Table 6-2. ID Commands

6.1.3 Reporting Commands

Reporting commands send specific information to the serial port. The commands listed in Table 6-3 can be used in all modes.

Command	Function
DUMPALL	List all parameter values
DUMPAUDIT	List audit trail information
DUMPBUFFER	List buffer information
DUMPIDS	List all ID information
VERSION	Write CW-90/90X software version
P	Write current displayed weight with units identifier (Section 8.3.2 on page 74)
ZZ	Write current weight and annunciator status (Section 8.3.2 on page 74)
XE	Returns a 10-digit code representing any error conditions currently shown on the front panel

Table 6-3. Reporting Commands



Note Transmitting all configuration settings can be achieved by the DUMPALL command or by pressing PRINT while in Menu mode.

6.1.4 Clear and Reset Commands

RESETCONFIGURATION can be used to clear and reset the CW-90/90X:

Reset System (**RS**) – resets the indicator without resetting the configuration.

RESETCONFIGURATION – restores all configuration parameters to the default values (menu mode only). A configuration reset can also be initiated by navigating to the **DEFAULT** parameter in the VERS menu and selecting **YES**. Press  to reset the indicator.

CLEARBUFFER – clears the buffer information.



Note All load cell calibration settings are lost when the RESETCONFIGURATION command is run.

6.1.5 Parameter Setting Commands

Parameter setting commands allows current value to be displayed or changed, for a configuration parameter.

Current configuration parameter settings can be displayed in all modes using the following syntax: `command<ENTER>`.

Most parameter values can be changed in menu mode only.

Use the following command syntax when changing parameter values: `command=value<ENTER>`, where value is a number or a parameter value. Use no spaces before or after the equal (=) sign. If an incorrect command is entered, the display reads `??`.

Example: to set the motion band parameter to 5 divisions, type the following: SC.MOTBAND=5<ENTER>

For parameters with selectable values, enter the command and equal sign followed by a question mark: `command=?<ENTER>` to see a list of those values. The indicator must be in menu mode to use this function.



Note

Some parameters are valid only if other parameters or parameter values are specified. Restrictions for front-panel configuration also apply to serial command configuration.

Command	Description	Values
SC.GRADS	Graduations	1–100000
SC.ZTRKBND	Zero track band	0, 0–100
SC.ZRANGE	Zero range	1.900000, 0–100
SC.MOTBAND	Motion band	1, 0–100
SC.SSTIME	Standstill time	1–65535
SC.OVRLOAD	Overload	FS+2%, FS+1D, FS+9D, FS
SC.DIGFLTR1 SC.DIGFLTR2 SC.DIGFLTR3	Digital filtering	1, 2, 4, 8, 16, 32, 64, 128, 256
SC.DFSENS	Digital filter cutout sensitivity	2OUT, 4OUT, 8OUT, 16OUT, 32OUT, 64OUT, 128OUT
SC.DFTHR	Digital filter cutout threshold	NONE, 2D, 5D, 10D, 20D, 50D, 100D, 200D, 250D
SC.THRESH	Zero threshold	0–9999999
SC.SMPRAT	Sample rate	30HZ, 60HZ, 120HZ, 240HZ, 480HZ, 960HZ
SC.PWRUPMD	Power up mode	GO, DELAY
SC.TAREFN	Tare function	BOTH, NOTARE, PBTARE, KEYED
SC.PRI.DECPNT	Primary units decimal position	8.888888, 88.88888, 888.8888, 8888.888, 88888.88, 888888.8, 8888888, 8888880, 8888800
SC.PRI.DSPDIV	Primary units display divisions	1D, 2D, 5D
SC.PRI.UNITS	Primary units	lb, kg, g, oz, lb/oz, CUSTOM, OFF
SC.PRI.CUNITS	Primary custom units	Specify units if SC.PRI.UNITS=CUSTOM
SC.ACCUM	Accumulator enable	ON, OFF
SC.VISIBLE	Scale visibility	ON, OFF
SC.WZERO	Zero calibration	—
SC.WVAL	Test weight value	test_weight_value
SC.WSPAN	Span calibration	—
SC.WLIN.F1–SC.WLIN.F5	Actual raw count value for linearization points 1–5	0–16777215
SC.WLIN.V1 SC.WLIN.V5	Test weight value for linearization points 1–5	0.000001–9999999
SC.WLIN.C1–SC.WLIN.C5	Calibrate linearization points 1–5	—
SC.LC.CD	Deadload coefficient	—
SC.LC.CW	Span coefficient	—
SC.LC.CZ	Temporary zero	—
SC.REZERO	Rezero	—
SC.SEC	Secondary units	lb, kg, g, oz, lb/oz, CUSTOM, OFF
SC.TER	Tertiary units	lb, kg, g, oz, lb/oz, CUSTOM, OFF

Table 6-4. SCALES Serial Commands

Command	Description	Values
EDP.BAUD#p	Port baud rate	1200, 2400, 4800, 9600, 19200, 28800, 38400, 57600, 115200
EDP.BITS#p	Port data bits/parity	8NONE, 7EVEN, 7ODD
EDP.TERMIN#p	Port termination character	CR/LF, CR
EDP.STOPBITS#p	Port stop bits	2, 1
EDP.PRMSG#P	Print message	ON, OFF
EDP.ECHO#p	Port echo	ON, OFF
EDP.EOLDLY#p	Port end-of-line delay	0–255 (0.1-second intervals)
EDP.TRIGGER#p	Port trigger	DEMAND, STREAM, COMAND, WAITSS, TARGET, L-STAB, OFF
EDP.TRIGACT#p	Port trigger action	ACCEPT, ALL
STR.POS	Custom stream identifiers	None, Space, +
STR.NEG		None, Space, +
STR.PRI		8 alphanumeric characters
STR.SEC		8 alphanumeric characters
STR.TER		8 alphanumeric characters
STR.GROSS		8 alphanumeric characters
STR.NET		8 alphanumeric characters
STR.TARE		8 alphanumeric characters
STR.MOTION		2 alphanumeric characters
STR.RANGE		2 alphanumeric characters
STR.OK		2 alphanumeric characters
STR.INVALID		2 alphanumeric characters
STR.ZERO		2 alphanumeric characters

For commands ending with #p, p is the port number.

Table 6-5. SERIAL Port Serial Commands

Command	Description	Values
DATATYPE	Selects how transactions (automatic prints) are handled	OFF, VAULT, BUFFER
DATAPORT	Turns buffer off or on	OFF, PORT 1, PORT 2, PORT 3
MODE	Sets checkweighing mode	RANGE, TARGWT, TARG%
VALSET	Value set	KEYED, PUSH, BOTH, RONLY
NEGCKW	Sets negative checkweighing	OFF, ON, AUTO
ID	Turns IDs off or on	OFF, ON
LIGHTS	Sets the lights display	SOLID, GRAPH, OFF
CFGPWD	Configuration password	0, 1–9999999
CONSNUM	Consecutive numbering	0–9999999
CONSTUP	Consecutive number start-up value	0–9999999
DATEFMT	Date format	MMDDYYYY, DDMMYYYY, YYYYMMDD, YYYYDDMM
DATESEP	Date separator	SLASH, DASH, SEMI
DECfmt	Decimal format	DOT, COMMA
DSPBRIGHT	Sets display intensity	0 (dimkest), 1, 2, 3, 4, 5, 6, 7 (brightest)
KYBDLK	Keyboard lock (disable keypad)	OFF, ON
REGULAT	Regulatory compliance	NONE, OIML, NTEP, CANADA, INDUST
REG.HLDWGH	Allow weightment during display hold	NO, YES
REG.CTARE	Allow clear keyed tare	NO, YES
REG.HTARE	Allow tare in display hold	NO, YES
REG.KTARE	Always allow keyed tare	NO, YES
REG.MTARE	Multiple tare action	REPLACE, REMOVE, NOTHING
REG.NTARE	Allow negative tare	NO, YES
REG.ZTARE	Remove tare on ZERO	NO, YES
REG.RTARE	Round push button tare to nearest display division	NO, YES
REG.MOTWGH	Allow weightment in motion	NO, YES
REG.OVRBASE	Zero base for overload calculation	CALIB ZERO, SCALE ZERO
REG.PRTMOT	Allow print while in motion	NO, YES
REG.PRINTPT	Add PT to keyed tare print	NO, YES
REG.PRTHLD	Print during display hold	NO, YES
REG.SNPSHOT	Display or Scale weight source	DISPLAY, SCALE
REGWORD	Regulatory word	GROSS, BRUTTO
SD	Set date	MMDDYY, DDMMYY, YYYYMMDD, or YYDDMM. Enter six-digit date using the year-month-day order specified for the DATEFMT parameter, using only the last two digits of the year
ST	Set time	hhmm (enter using 24-hour format)
TIMEFMT	Time format	12HOUR, 24HOUR
TIMESEP	Time separator	COLON, COMMA
ZERONLY	Disable all keys except ZERO	OFF, ON

Table 6-6. FEATURE Serial Commands

Command	Description	Values
GFMT.FMT	Gross demand print format string	See Section 7.0 on page 69 for information about demand print format strings
NFMT.FMT	Net demand print format string	
ACC.FMT	Accumulator print format string	
BUF.FMT	Buffer print format string	
STRM.FMT	Streaming Format	See Section 6.2 on page 67 for information about custom stream formatting
HDRFMT1	Header 1 Format	Enter the data you want displayed in Header 1
HDRFMT2	Header 2 Format	Enter the data you want displayed in Header 2

Table 6-7. PFORMT Serial Commands

Command	Description	Values
DIO#b	Digital input function	OFF, OVERKEY, UNDERKEY, TARGETKEY, IDKEY, PRINT, ZERO, TARE, UNITS, ENTER, CLEAR, DSPACC, CLRACC, TIMEDATE, DSPTAR, CLRTAR, KEYLCK, HOLD, CLRCN, NT/GRS
DIO#b	Digital output function	OVER, UNDER, ACCEPT, ZEROBD
DIO.TIMER#b	Digital output timer function	0-65, 535
DIO.TRIP#b	Digital output trip functionality	STABLE FRERUN
Digital inputs and outputs are specified by bit number. Valid bit values (b) are 1-4.		

Table 6-8. DIG I/O Serial Commands

6.1.6 Normal Mode Commands

The normal mode print commands transmit data to the serial port on demand in either setup or normal mode.

Command	Description	Values
CONSNUM	Set consecutive number	0-9 999 999
UID	Set unit ID	nnnnnnn
SD	Set date	MMDDYY, DDMMYY, YYMMDD, or YYDDMM; Enter six-digit date using the year-month-day order specified for the DATEFMT parameter, using only the last two digits of the year
ST	Set time	hhmm (enter using 24-hour format)
SX#p	Start serial port streaming	OK or ??
EX#p	Stop serial port streaming	The port TRIGGE parameter (EDP.TRIGGER#p) for the streaming port must be set to STREAM before using these commands; An EX command sent while in menu mode does not take effect until the indicator is returned to normal mode
XG	Transmit gross weight in displayed units	nnnnnn UU Where nnnnnn is the weight value, UU is the units NOTE: Send XGP, XGS, XGT, XTP, etc. to specify primary, secondary or tertiary (P.S.T.).
XN	Transmit net weight in displayed units	
XT	Transmit tare weight in displayed units	
XA	Transmit accumulator value	
RS	Reset system	Soft reset; Used to reset the indicator without resetting the configuration to the factory defaults
DUMPBUFFER	Buffer commands	Transmits the contents of the buffer
CLEARBUFFER		Clears the entire buffer
For commands ending with #p, p is the port number.		

Table 6-9. Normal Mode Serial Commands

6.1.7 Unique Commands

Command	Description
EDP.PORT	Returns the port currently connected to

Table 6-10. Unique Commands

6.2 Custom Stream Formatting

Each communication port can be independently configured to stream continuous data. The default stream format is <2><P><W7.><U><M><S><CR><LF>. The Format Identifiers are described in [Table 6-11](#). The steam format can be configured using a serial EDP command (STRM.FMT), the front panel (STRM.FM under the PFORMT menu), or the Revolution configuration utility. It is customized in a similar fashion as the print formats ([Section 7.2 on page 70](#)).



Note

Even though each port can be independently configured to stream continuous data, there is only one stream format. Therefore, all ports configured to stream will stream the same data format.

Format Identifier	Defined By	Description
<P[G N T]>	STR.POS STR.NEG	Polarity; Specifies positive or negative polarity for the current or specified (Gross/Net/Tare) weight on the source scale; Possible values are SPACE, NONE, + (for STR.POS), or - (for STR.NEG)
<CU>	STR.PRI STR.SEC STR.TER	Units; Specifies primary, secondary, or tertiary units for the current or specified weight on the source scale
<U[P S T]>	Dynamic	=L if Units=LB =K if Units=KG =G if Units=G =O if Units=OZ =space if Units=LB/OZ
<M[G N T]>	STR.GROSS STR.NET STR.TARE	Mode – Specifies gross, net, or tare weight for the current or specified weight on the source scale
<S>	STR.MOTION STR.RANGE STR.OK STR.INVALID	Status for the source scale; Default values and meanings for each status: STR.MOTION M In motion STR.RANGE O Out of range STR.OK <space> OK STR.INVALID I Invalid
<CW>	—	Status of over/under/accept. O=Over, U=Under, A=Accept.
<B [-]n,...>	See descriptions below	Bit fields; Comma-separated sequence of bit field specifiers; Must be exactly 8 bits; Minus sign ([–]) inverts the bit
B0	—	Always 0
B1	—	Always 1
B2	Configuration	=1 if even parity
B3	Dynamic	=1 if MODE=NET
B4	Dynamic	=1 if COZ
B5	Dynamic	=1 if standstill
B6	Dynamic	=1 if gross negative
B7	Dynamic	=1 if out of range
B8	Dynamic	=1 if secondary/tertiary
B9	Dynamic	=1 if tare in system
B10	Dynamic	=1 if tare is keyed
B11	Dynamic	=00 if MODE=GROSS =01 if MODE=NET =10 if MODE=TARE =11 (not used)
B12	Dynamic	=00 if UNITS=PRIMARY =01 if UNITS=SECONDARY =10 if UNITS=TERTIARY =11 (not used)

Table 6-11. Custom Stream Format Identifiers

Format Identifier	Defined By	Description
B13	Configuration	=00 (not used) =01 if current DSPDIV=1 =10 if current DSPDIV=2 =11 if current DSPDIV=5
B14	Configuration	=00 (not used) =01 if primary DSPDIV=1 =10 if primary DSPDIV=2 =11 if primary DSPDIV=5
B15	Configuration	=00 (not used) =01 if secondary DSPDIV=1 =10 if secondary DSPDIV=2 =11 if secondary DSPDIV=5
B16	Configuration	=00 (not used) =01 if tertiary DSPDIV=1 =10 if tertiary DSPDIV=2 =11 if tertiary DSPDIV=5
B17	Configuration	=000 if current DECPNT=8888800 =001 if current DECPNT=8888880 =010 if current DECPNT=8888888 =011 if current DECPNT=888888.8 =100 if current DECPNT=88888.88 =101 if current DECPNT=8888.888 =110 if current DECPNT=888.8888 =111 if current DECPNT=88.88888
B18	Configuration	=000 if primary DECPNT=8888800 =001 if primary DECPNT=8888880 =010 if primary DECPNT=8888888 =011 if primary DECPNT=888888.8 =100 if primary DECPNT=88888.88 =101 if primary DECPNT=8888.888 =110 if primary DECPNT=888.8888 =111 if primary DECPNT=88.88888
B19	Configuration	=000 if secondary DECPNT=8888800 =001 if secondary DECPNT=8888880 =010 if secondary DECPNT=8888888 =011 if secondary DECPNT=888888.8 =100 if secondary DECPNT=88888.88 =101 if secondary DECPNT=8888.888 =110 if secondary DECPNT=888.8888 =111 if secondary DECPNT=88.88888
B20	Configuration	=000 if tertiary DECPNT=8888800 =001 if tertiary DECPNT=8888880 =010 if tertiary DECPNT=8888888 =011 if tertiary DECPNT=888888.8 =100 if tertiary DECPNT=88888.88 =101 if tertiary DECPNT=8888.888 =110 if tertiary DECPNT=888.8888 =111 if tertiary DECPNT=88.88888
<wspec [-] [0] digit[.[.]digit>	Scale weight	Weight for the source scale (wspec) indicates if the current displayed weight (W, w), gross (G, g), net (N, n), or tare (T, t) weight; Upper-case letters specify right-justified weights; Lower-case are left-justified; Optional /P, /S, or /T suffixes can be added before the ending delimiter (>) to specify weight display in primary (/P), secondary (/S), or tertiary (/T) units; [-] Enter a minus sign (-) to include sign for negative values; [0] Enter a zero (0) to display leading zeros; digit[.[.]digit] – First digit indicates the field width in characters; Decimal point only indicates floating decimal; Decimal point with following digit indicates fixed decimal with n digits to the right of the decimal; Two consecutive decimals send the decimal point even if it falls at the end of the transmitted weight field
<CR>	—	Carriage return
<LF>	—	Line feed

Table 6-11. Custom Stream Format Identifiers (Continued)

7.0 Print Formatting

The CW-90/90X provides six print formats: Gross Weight (**GFMT.FMT**), Net Weight (**NFMT.FMT**), Accumulator (**ACC.FMT**), Buffer (**BUF.FMT**), and two Header formats (**HDRFMT1** and **HDRFMT2**). These determine the format of the printed output when the **PRINT** key is pressed or when a **KPRINT** EDP command is received. The **GFMT** and **NFMT** will print to all ports assigned as **DEMAND** in the **TRIGGE** parameter, based on whether a tare is in the indicator. The Accumulator (**ACC.FMT**) will print to all **DEMAND** ports when the **PRINT** key is pressed while the **ACCUM** is displays. The Header formats (**HDRFMT1** and **HDRFMT2**) can be inserted into the other formats using the <H1> and <H2> formatting commands.

Each print format can be customized to include up to 300 characters of information, such as company name and address, on printed tickets. Use the indicator front panel (**PFORMT** menu), EDP commands, or the Revolution configuration utility to customize the print formats.

7.1 Print Formatting Commands

Print Formatting Commands can be used to format any of the print formats. Commands included in the format strings must be enclosed between < and > delimiters. Any characters outside of the delimiters are printed as text on the ticket.

Text characters can include any ASCII character that can be printed by the output device.

Command	Description
<G>	Gross weight in displayed units
<N>	Net weight in displayed units
<T>	Tare weight in displayed units
<A>	Accumulated weight in displayed units
<CKS>	Status of over/under/accept; O=Over, U=Under, A=Accept space=Zero band
<CKOV>	Over value
<CKUV>	Under value
<CKTV>	Target value
<CKID>	Loaded ID number
<CKD1>	Description 1
<CKD2>	Description 2
<CKU>	Units
<CKT>	Tare
<AC>	Number of accumulator events (5-digit counter)
<AD>	Date of last accumulator event
<AT>	Time of last accumulator event
<UID>	Unit ID number
<CN>	Consecutive number
<NLnn>	New line (nn = number of termination (<CR/LF> or <CR>) characters)*
<SPnn>	Space (nn = number of spaces)*
<SU>	Toggle weight data format (formatted/unformatted)**
<TI>	Time
<nnn>	ASCII character (nnn - decimal value of ASCII character; Used for inserting control characters (STX for example) in the print stream
<DA>	Date
<TD>	Time & Date
<H1>	Header 1
<H2>	Header 2
Gross, net, and tare weights are 8 digits in length, including sign and decimal point, followed by a space and a one- to five-character units identifier; Total field length with units identifier is 10-14 characters; Depending on what units are configured, the units identifier will be lb/oz, lb, oz, g, or kg	
Gross, net, tare, and accumulator weights can be printed in any configured weight units by adding the following modifiers to the gross, net, tare, and accumulator weight commands: /P (primary units), /D (displayed units), /S (secondary units), /T (tertiary units); If not specified, the current displayed units (/D) is assumed; Example: To format a ticket to show net weight in secondary units, use the following command: <N/S>	
ID and consecutive number (CN) fields are 1–6 characters in length, as required	
*If nn is not specified, 1 is assumed; Value must be in the range 1–99	
**After receiving an SU command, the indicator sends unformatted data until the next SU command is received; Unformatted data omits decimal points, leading and trailing characters.	

Table 7-1. Print Format Commands

The default CW-90/90X print formats are shown below:

Format	Default Format String	Sample Output
GFMT.FMT	<G> GROSS<NL>	2046.81 lb GROSS
NFMT.FMT	<G> GROSS<NL> <T> TARE<NL> <N> NET<NL>	4053.1 lb GROSS 15.6 lb TARE 4037.5 lb NET
HDRFMT1	Company Name <NL> Street Address <NL> City, ST ZIP <NL2>	Company Name, Street Address, City, ST ZIP
HDRFMT2	Company Name <NL> Street Address <NL> City, ST ZIP <NL2>	Company Name, Street Address, City, ST ZIP
BUF.FMT	<CKID><G><NL>	ID1 3.00 lb
ACC.FMT	ACCUM<A><NL> <DA><TI><NL>	ACCUM 27.00 lb 06/03/2010 10:01AM

Table 7-2. GFMT, NFMT, H1, H2, BUF, and ACC Formats



Note

The 300-character limit of each print format string includes the output field length of the print formatting commands, not the command length. For example, the <G> command generates an output field of 10 to 14 characters: the 8-digit weight value, one space, and a one- to five-character units identifier.

7.2 Customizing Print Formats

The following sections describe procedures for customizing the print formats using the Serial EDP commands, the front panel (**PFORMAT** menu), and the Revolution configuration utility.

7.2.1 Using the EDP Port

With a personal computer, terminal, or remote keyboard attached to the CW-90/90X EDP port, you can use the EDP command set to customize the print format strings.

To view the current setting of a format string, type the EDP command for the print format string (**GFMT.FMT**, **NFMT.FMT**, **BUF.FMT**, **ACC.FMT**, **HDRFMT1**, or **HDRFMT2**) and press **Enter**. For example, to check the current configuration of the **GFMT** format, type **GFMT.FMT** and press **Enter**. The indicator responds by sending the current configuration for the gross format:

```
GFMT.FMT=<G> GROSS<NL>
```

To change the format, use the print format EDP command, followed by the equals sign (=), and the modified print format string. For example, to add the name and address of a company to the gross format, you could send the following EDP command:



Note

Indicator must be placed in the configuration mode with **CONFIG** shown on the display.

```
GFMT.FMT=FINE TRANSFER CO<NL>32400 WEST HIGHWAY ROAD<NL>SMALLTOWN<NL2><G> GROSS<NL>
```

A ticket printed using this format might look like the following:

```
FINE TRANSFER CO
32400 WEST HIGHWAY ROAD
SMALLTOWN
```

```
1345 lb GROSS
```

7.2.2 Using the Front Panel

If there is no access to equipment for communication through the EDP port or at a site where such equipment cannot be used, use the **PFORMAT** menu to customize the print formats.

Using the **PFORMAT** menu, edit the print format strings by changing the decimal values of the ASCII characters in the format string.



Lower-case letters and some special characters cannot be displayed on the CW-90/90X front panel and are shown as blanks. The CW-90/90X can send or receive any ASCII character; the character printed depends on the particular ASCII character set implemented for the receiving device.

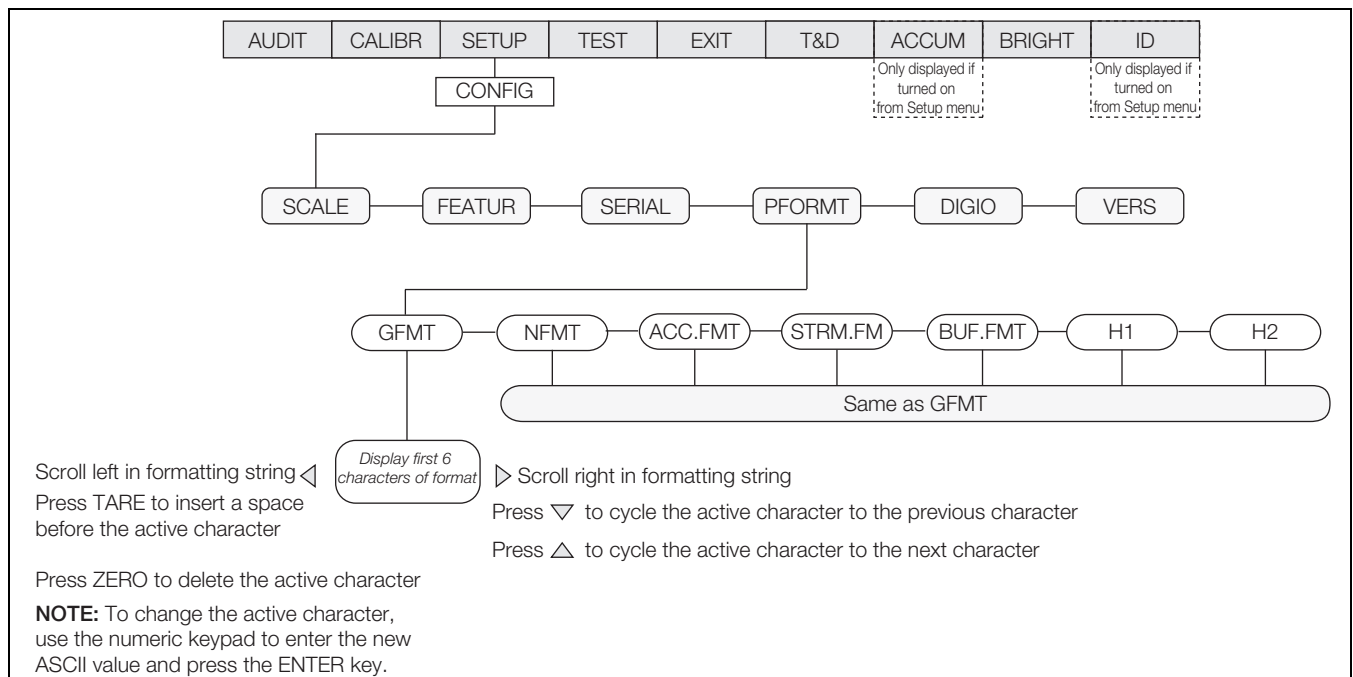

Figure 7-1. PFORMAT Menu, Showing Alphanumeric Character Entry Procedure



Press the down arrow to cycle to the previous character. Press the up arrow to cycle to the next character. To send a decimal point, enclose it in brackets, <.> or cycle through the characters until the decimal point is displayed.

7.2.3 Using Revolution

The Revolution configuration utility provides a print formatting grid with a tool bar. The grid allows the print format setup without the formatting commands (<NL> and <SP>) required by the front panel or EDP command methods. Using Revolution, type text directly into the grid, then select weight value fields from the tool bar and place them where they should display on the ticket.

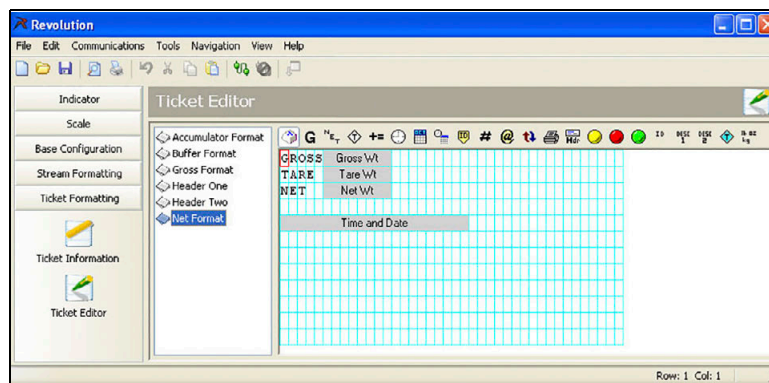

Figure 7-2. Revolution Print Format Grid

8.0 Appendix

8.1 Error Messages

If the error cannot be cleared, call Rice Lake Weighing Systems Service for assistance.

Error Display	Description	Solution
	Over range	<ul style="list-style-type: none"> • Check load cell wiring, including sense jumpers • Check configuration, including number of grads and display divisions • Check calibration, including W ZERO and W SPAN values • Under range can be caused by OIML setting and weight less than -20 display divisions • Check for scale binding or damage • Check for proper excitation voltage • Call Rice Lake Weighing Systems Service for assistance
	Under range	
	A/D out of range	
CHKERR	Checksum error on power up CHKERR will appear briefly, then BATTERY BACK LOST will scroll on a failure to write to NVRAM	Press the ENTER key after replacing the battery to restore defaults to battery backed storage
CFGERR	Configuration error on power up if there was an error loading configuration	Press the ENTER key to reboot the indicator; Contact Rice Lake Weighing Systems Service if problem reoccurs
ERROR	Internal program error	Check configuration; Run XE command (Section 8.2 on page 73) to determine error type; Call Rice Lake Weighing Systems Service if unable to clear error by cycling power or if error reoccurs
HWFERR	Hardware failure error on failure to write to the EEPROM any error when exiting the menu	Reboot the unit; call Rice Lake Weighing Systems Service if unable to clear error by cycling power or if error reoccurs
LOWBATT	Low battery error flashes every 30 seconds when the battery is low.	Replace the battery
NOLOAD	ID not loaded	The IDs over/under/target/or tare do not match the current count by
FAILED	Failed to acquire target value	Attempt to acquire the current weight on the scale to the current ID failed
NO ID	The requested ID was not found	Verify that you are entering the ID correctly and that the ID exists
BUFFER	The buffer is nearing capacity when using the buffer or WeighVault functionality	If using Buffer - dump the buffer contents to a PC by using the DUMPBUFFER command; After successfully receiving the buffer contents on the PC send the CLEARBUFFER command to empty the buffer; If using WeighVault - establish a connection to the WeighVault PC so that it can retrieve transactions from the CW-90
FULL	The buffer is full when using the buffer or WeighVault functionality	
INVALID UNITS	ID uses unassigned units	Modify the ID to use a configured unit
NOTARE	Tare is prevented	Change regulatory mode settings or the TAREFN parameter
RANGE	GRADS > 100,000 WVAL > 999999.0 Configuration value out of range	A value entered in configuration is out of the acceptable range; Ranges for all parameters are listed in the Parameter Settings Commands section
CNT-BY	Count By Error	This occurs when the value entered exceeds the resolution (Count By) of the scale

Table 8-1. CW-90/90X Error Messages



Note

If all annunciators on both sides and the center dashes on the display are lit, check the load cell connection.

8.2 Using the XE EDP Command

The XE EDP command can be used to remotely query the CW-90/90X for the error conditions shown on the front panel. The XE command returns a 5-digit number in the format:

xxxxx yyyyy

where xxxxx contains a decimal representation of existing error conditions.

If more than one error condition exists, the number returned is the sum of the values representing the error conditions.

Example: if the XE command returns the number 1040, this value represents the sum of an A/D reference error (1024) and an A/D calibration checksum error (16).

XE Error Code	Description	XEH Hex Value
1	VIRGERR	0x00000001
2	PARMCHKERR	0x00000002
4	LOADCHKERR	0x00000004
8	PRINTCHKERR	0x00000008
16	ENVRAMERR	0x00000010
32	ENVCRCERR	0x00000020
64	BATTERYERR	0x00000040
32768	GRAVERR	0x00008000
65536	ADPHYSICALERR	0x00010000
131072	TAREERR	0x00020000
262144	EACCOVER	0x00040000
524288	STRINGERR	0x00080000
1048576	RESERVED_PF	0x00100000
2097152	RTCERR	0x00200000
4194304	MISSINGHWERR	0x00400000
8388608	CFGCONFLICTERR	0x00800000
16777216	UNRECOVERABLEERR	0x01000000
0x10000 - 0x80000000		Reserved

Table 8-2. Error Codes Returned on XE Command

8.3 Status Messages

Two EDP commands, P and ZZ, can be used to provide status about the indicator. These commands are described in the following sections.

8.3.1 Using the P EDP Command

The P EDP command returns the current displayed weight value to the EDP port, along with the units identifier. If the indicator is in an under range or overload condition, the weight value is replaced with ^^^^^^ (overload) or _ _ _ _ _ (under range).

8.3.2 Using the ZZ EDP Command

The ZZ EDP command can be used to remotely query which annunciators are currently displayed on the indicator front panel. The ZZ command returns the currently displayed weight and a decimal number representing the LED annunciators currently lit. The format of the returned data is:

wwwwww uu zzz

where wwwwww uu is the current displayed weight and units, zzz is the annunciator status value. If more than one annunciator is lit, the second number returned is the sum of the values representing the active annunciators.

Example: If the annunciator status value returned on the ZZ command is 145, the gross, standstill, and lb annunciators are lit. 145 represents the sum of the values for the standstill annunciator (128), gross mode annunciator (16), and the lb/primary units annunciator (1).

Decimal Value	Annunciator
1	lb/primary units
2	kg/secondary units
4	Count
8	Tare entered
16	Gross
32	Net
64	Center of zero
128	Standstill

Table 8-3. Status Codes Returned on the ZZ Command

8.4 Continuous Output (Stream) Format

Each communications port can be independently configured to stream Continuous Data by setting then Port's **TRIGGE** parameter to **STREAM**. The default format of the stream output is shown in Figure 8-1. The output can be customized (Section 6.2 on page 67).

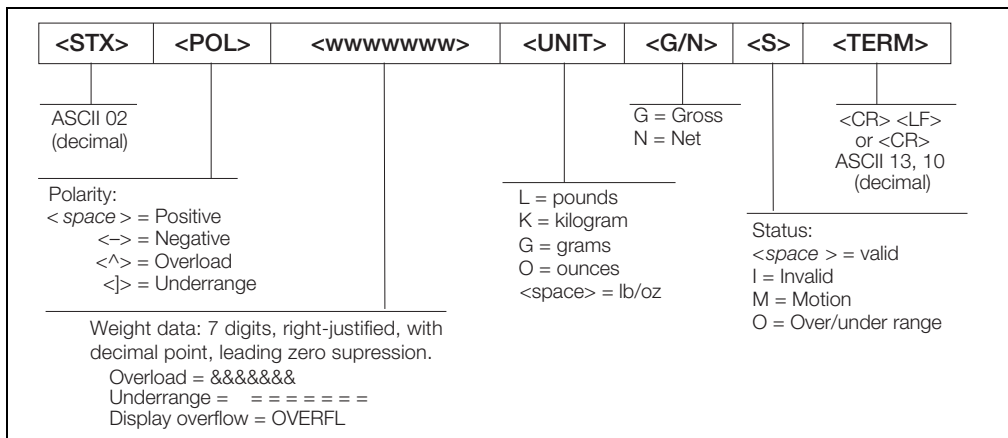

Figure 8-1. Default Continuous Output Data Format

8.5 Digital Filtering

The CW-90/90X uses averaged digital filtering to reduce the effect of vibration on weight readings. Adjustable threshold and sensitivity functions allow quick settling by suspending filter averaging, allowing the weight reading to jump to the new value.

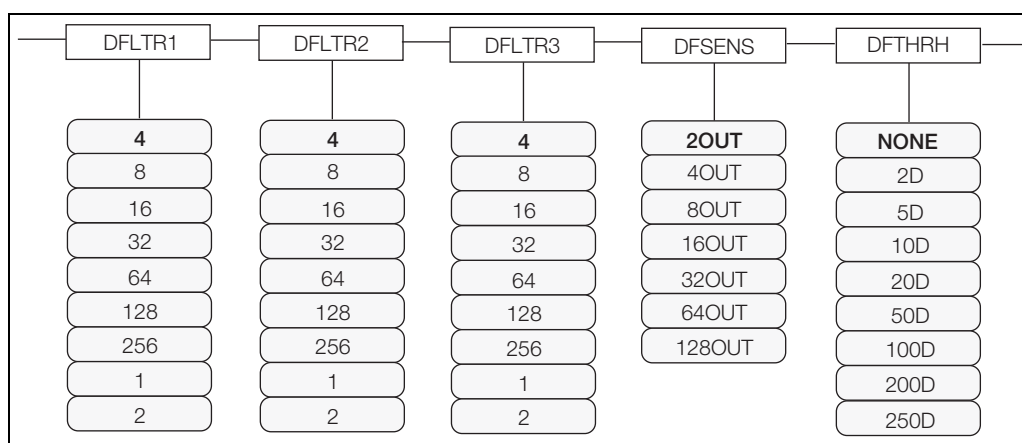

Figure 8-2. Digital Filtering Parameters on the Configuration (CONFIG) Menu

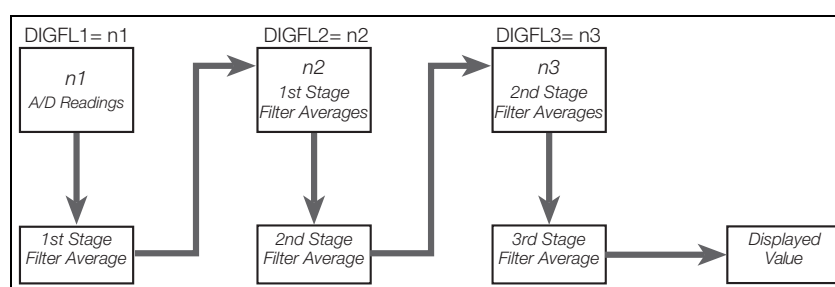

Figure 8-3. Flow Diagram for CW-90/90X Digital Filters

8.5.1 DIGFLx Parameters

The first three digital filtering parameters, DFLTR1, DFLTR2, and DFLTR3, are configurable filter stages that control the effect of a single A/D reading on the displayed weight. The value assigned to each parameter sets the number of readings received from the preceding filter stage before averaging.

The overall filtering effect can be expressed by adding the values assigned to the three filter stages:

$$\text{DFLTR1} + \text{DFLTR2} + \text{DFLTR3}$$

Example: if the filters are configured as DFLTR1=4, DFLTR2=8, DFLTR3=8, the overall filtering effect is 20 (4 + 8 + 8). With this configuration, each A/D reading has a 1-in-20 effect on the displayed weight value. Setting the filters to 1 effectively disables digital filtering.

8.5.2 DFSENS and DFTHRH Parameters

The three digital filters can be used by themselves to eliminate vibration effects, but heavy filtering also increases settling time. The DFSENS (digital filter sensitivity) and DFTHRH (digital filter threshold) parameters can be used to temporarily override filter averaging and improve settling time:

- DFSENS specifies the number of consecutive scale readings that must fall outside the filter threshold (DFTHRH) before digital filtering is suspended
- DFTHRH sets a threshold value, in display divisions. When a specified number of consecutive scale readings (DFSENS) fall outside of this threshold, digital filtering is suspended. Set DFTHRH to NONE to turn off the filter override

8.5.3 Setting the Digital Filter Parameters

Fine-tuning the digital filter parameters greatly improves indicator performance in heavy-vibration environments.

Use the following procedure to determine vibration effects on the scale and optimize the digital filtering configuration.

1. In menu mode, set all three digital filters (DFLTR1, DFLTRL2, DFLTR3) to 1. Set DFTHRH to NONE. Return indicator to normal mode.
2. Remove all weight from the scale, then watch the indicator display to determine the magnitude of vibration effects on the scale. Record the weight below which all but a few readings fall. This value is used to calculate the DFTHRH parameter value in [Step 4](#).

For example, if a heavy-capacity scale produces vibration-related readings of up to 50 lb, with occasional spikes to 75 lb, record 50 lb as the threshold weight value.

3. Place the indicator in menu mode and set the digital filters (DFLTRx) to eliminate the vibration effects on the scale. (Leave DFTHRH set to NONE.) Reconfigure as necessary to find the lowest effective values for the DFLTRx parameters.
4. With optimum values assigned to the DFLTRx parameters, calculate the DFTHRH parameter value by converting the weight value recorded in [Step 2](#) to display divisions:

$$\text{threshold_weight_value} / \text{DSPDIV}$$

In the example in [Step 2](#), with a threshold weight value of 50 lb and a display division value of 5lb: $50 / 5 \text{ lb} = 10DD$. DFTHRH should be set to 10DD for this example.

5. Set the DFSENS parameter high enough to ignore transient peaks. Longer transients (typically caused by lower vibration frequencies) will cause more consecutive out-of-band readings, so DFSENS should be set higher to counter low frequency transients.

Reconfigure as necessary to find the lowest effective value for the DFSENS parameter.

8.5.4 Audit Trail Support

Audit trail support provides tracking information for configuration and calibration events. To prevent potential misuse, all configuration and calibration changes are counted as change events.

Use the Audit menu or Revolution to display audit trail information. This includes the legally relevant (LR) version number (software version for the code that provides audit trail information), a calibration count and, if REGULA=NTEP, a configuration count. The exact format of the information shown depends on the regulatory agency specified for the REGULA parameter (FEATUR menu).

Audit trail information can be printed from Revolution or by sending the DUMPAUDIT serial command.

8.6 Regulatory Mode Functions

The function of the front panel **TARE** and **ZERO** keys depends on the value specified for the **REGULAT** parameter on the **FEATURE** menu. The following table describes the function of these keys for the **NTEP**, **CANADA**, **OIML**, and **NONE** regulatory modes. **TARE** and **ZERO** key functions are configurable when the **REGULAT** mode is set to **INDUST**.

REGULAT Parameter Value	Weight on Scale	Tare in System	Front Panel Key Function	
			TARE	ZERO
NTEP	zero or negative	no	no action	ZERO
		yes	CLEAR TARE	
	positive	no	TARE	
		yes	TARE	
CANADA	zero or negative	no	no action	ZERO
		yes	CLEAR TARE	
	positive	no	TARE	
		yes	no action	
OIML	zero or negative (not to exceed -20dd)	no	no action	ZERO
		yes	CLEAR TARE	ZERO and CLEAR TARE
	positive	no	TARE	ZERO
		yes	TARE	ZERO/CLEAR TARE if weight is within ZRANGE No action if weight is outside of ZRANGE
NONE	zero or negative	no	TARE	ZERO
		yes	CLEAR TARE	
	positive	no	TARE	
		yes	CLEAR TARE	

Table 8-4. TARE and ZERO Key Functions for REGULAT Parameter Settings

IMPORTANT

If using a regulatory mode, it is the installers responsibility to make sure that the maximum allowable number of divisions is not exceeded by primary, secondary or tertiary units of measure (Section 3.4 on page 19).

In this situation, the installer must reduce the number of divisions (also reducing the maximum displayed capacity of the indicator) of the broader unit of measure to make sure that both units are less than the allowed maximum per regulatory accreditation.

The following table lists the sub-parameters available when configuring a scale using **INDUST** mode. The table includes the default values of the **INDUST** sub-parameters and the effective (not configurable) values used by the **NTEP**, **CANADA**, **OIML**, and **NONE** regulatory modes.

REGULAT / INDUST Parameter		REGULAT Mode				
Parameter Name	Text Prompt	INDUST	NTEP	CANADA	OIML	NONE
SNPSHOT	Display or Scale weight source	DISPLAY	DISPLAY	DISPLAY	DISPLAY	SCALE
HTARE	Allow tare in display hold	NO	NO	NO	NO	YES
ZTARE	Remove tare on ZERO	NO	NO	NO	YES	NO
KTARE	Always allow keyed tare	YES	YES	NO	YES	YES
MTARE	Multiple tare action	REPLACE	REPLACE	NOTHING	REPLACE	REMOVE
NTARE	Allow negative tare	NO	NO	NO	NO	YES
CTARE	Allow CLEAR key to clear tare/accumulator	YES	YES	NO	NO	YES
RTARE	Round push button tare to nearest display division	YES	YES	YES	NO	YES
PRTMOT	Allow print while in motion	NO	NO	NO	NO	YES
PRTPT	Add PT to keyed tare print	NO	NO	YES	YES	NO
PRTHLD	Print during display hold	NO	NO	NO	NO	YES
HLDWGH	Allow weigh during display hold	NO	NO	NO	NO	YES
MOTWGH	Allow weighment in motion	NO	NO	NO	NO	NO
OVRBASE	Zero base for overload calculation	CALIB ZERO	CALIB ZERO	CALIB ZERO	SCALE ZERO	CALIB ZERO

Table 8-5. REGULAT / INDUST Mode Parameters, Comparison with Effective Values of Other Modes

8.7 Updating CW-90/90X Firmware

To update firmware of the CW-90/90X, Revolution must be installed and a .hex file on the computer. Visit www.RiceLake.com to download this free configuration software and the latest .hex file.



Note *If the .hex file is the same version currently in the indicator, the firmware update will not reset the configuration. This is helpful if the firmware becomes corrupt and you want to reload the same firmware. It is always recommended that configuration be backed up in Revolution to avoid any data loss.*

1. Unplug power to the CW-90/90X and remove the back plate.
2. Wire the serial cable to the CW-90/90X's Port 1. Refer to the following table for cable connection settings.

DB9 Cable (PN 171968)				CW-90/90X Connector (J2)		
Pin/Color	Signal	In/Out	Description	Pin	Description	In/Out
1/NA	DCD	In	Data Carrier Detect	NC	NA	NA
2/Red	RxD	In	Receive Data	3	Tx	Out
3/Orange	TxD	Out	Transmit Data	4	Rx	In
4/Yellow	DTR	Out	Data Terminal Ready	5	DTR	In
5/Green	GND	-----	Ground	1 or 2	Gnd	-----
6/NA	DSR	In	Data Set Ready	NC	NA	NA
7/Blue	RTS	Out	Request to Send	6	RTS	In
8/NA	CTS	In	Clear to Send	NC	NA	NA
9/NA	RI	In	Ring Indicator	NC	NA	NA

Table 8-6. Cable Connection Settings

3. Install jumpers on JP3 and JP4 as shown below:

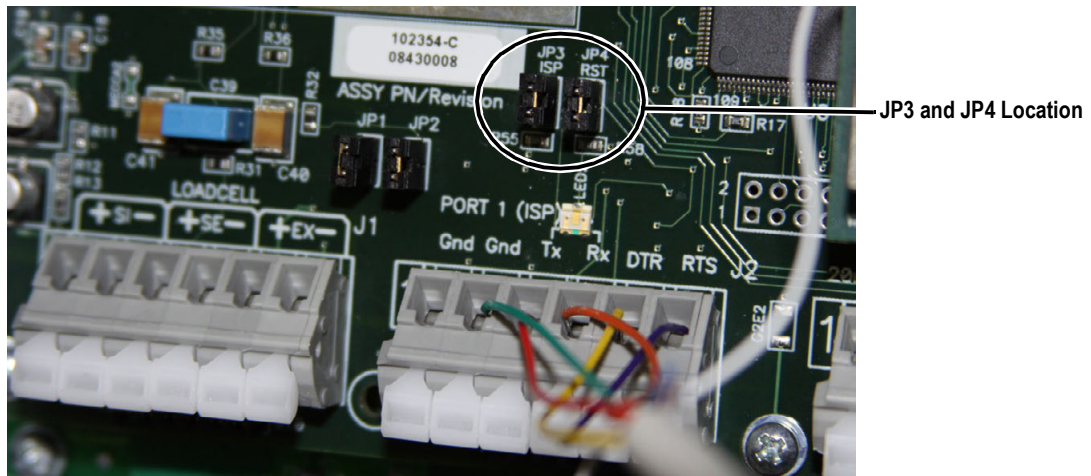

Figure 8-4. Jumpers Installed on JP3 and JP4

4. Plug in power to the CW-90/90X and turn on the indicator.
5. With Revolution open, begin a new configuration file for the CW-90/90X.

6. Select Update CW90 Firmware.



Figure 8-5. Revolution CW-90/90X Screen

7. The Rice Lake CW-90 Updater screen displays. Specify the COM port the CW-90/90X is connected to, change the baud rate if needed.
8. Press to browse to and select the desired .hex file.

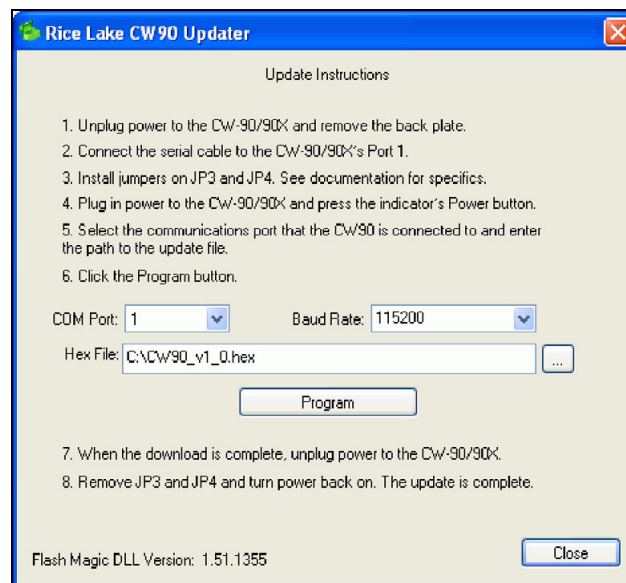

Figure 8-6. Rice Lake CW-90 Updater Screen

9. Press . The update takes several moments.
10. When complete, remove the jumpers shown in [Figure 8-4 on page 78](#) and power up the indicator.

9.0 CW-90/90X Limited Warranty

Rice Lake Weighing Systems (RLWS) warrants that all RLWS equipment and systems properly installed by a Distributor or Original Equipment Manufacturer (OEM) will operate per written specifications as confirmed by the Distributor/OEM and accepted by RLWS. The CW-90 system and components are warranted against defects in materials and workmanship for two years. The CW-90X system and components are warranted against defects in materials and workmanship for three years.

RLWS warrants that the equipment sold hereunder will conform to the current written specifications authorized by RLWS. RLWS warrants the equipment against faulty workmanship and defective materials. If any equipment fails to conform to these warranties, RLWS will, at its option, repair or replace such goods returned within the warranty period subject to the following conditions:

- Upon discovery by Buyer of such nonconformity, RLWS will be given prompt written notice with a detailed explanation of the alleged deficiencies.
- Individual electronic components returned to RLWS for warranty purposes must be packaged to prevent electrostatic discharge (ESD) damage in shipment. Packaging requirements are listed in a publication, *Protecting Your Components From Static Damage in Shipment*, available from RLWS Equipment Return Department.
- Examination of such equipment by RLWS confirms that the nonconformity actually exists, and was not caused by accident, misuse, neglect, alteration, improper installation, improper repair or improper testing; RLWS shall be the sole judge of all alleged non-conformities.
- Such equipment has not been modified, altered, or changed by any person other than RLWS or its duly authorized repair agents.
- RLWS will have a reasonable time to repair or replace the defective equipment. Buyer is responsible for shipping charges both ways.
- In no event will RLWS be responsible for travel time or on-location repairs, including assembly or disassembly of equipment, nor will RLWS be liable for the cost of any repairs made by others.



These warranties exclude all other warranties, expressed or implied, including without limitation warranties of merchantability or fitness for a particular purpose. Neither RLWS nor distributor will, in any event, be liable for incidental or consequential damages.

RLWS and buyer agree that RLWS's sole and exclusive liability hereunder is limited to repair or replacement of such goods. In accepting this warranty, the buyer waives any and all other claims to warranty.

Should the seller be other than RLWS, the buyer agrees to look only to the seller for warranty claims.

No terms, conditions, understanding, or agreements purporting to modify the terms of this warranty shall have any legal effect unless made in writing and signed by a corporate officer of RLWS and the Buyer.

10.0 Compliance

	EU DECLARATION OF CONFORMITY <i>EU-KONFORMITÄTSERKLÄRUNG DÉCLARATION UE DE CONFORMITÉ</i>		Rice Lake Weighing Systems 230 West Coleman Street Rice Lake, Wisconsin 54868 United States of America 
	Type/Typ/Type: CW90 and CW90X		
English	We declare under our sole responsibility that the products to which this declaration refers to, is in conformity with the following standard(s) or other regulations document(s).		
Deutsch	Wir erklären unter unserer alleinigen Verantwortung, dass die Produkte auf die sich diese Erklärung bezieht, den folgenden Normen und Regulierungsbestimmungen entsprechen.		
Français	Nous déclarons sous notre responsabilité que les produits auxquels se rapporte la présente déclaration, sont conformes à la/aux norme/s suivante ou au/aux document/s normatif/s suivant/s.		
EU Directive	Certificates	Standards Used / Notified Body Involvement	
2014/30/EU EMC	-	EN 55011:2007+A2:2007, EN 61326-1:2006	
2014/35/EU LVD	-	EN 60950-1-03:2006	
2011/65/EU RoHS	-	EN 50581:2012	
Signature:			Place: <u>Rice Lake, WI USA</u>
Type Name:	<u>Richard Shipman</u>		Date: <u>May 3, 2019</u>
Title:	<u>Quality Manager</u>		

11.0 Specifications

115VAC					
Part No.	Capacity (enter in pounds (kg) or ounces)		Platform Dimensions	Column Height	Est. Ship Weight
105957	5 x 0.001 lb (2.5 x 0.0005 kg)	80 x 0.02oz	10 x 10 x 4.25"	12"	29 lb
105958	10 x 0.002 lb (5 x 0.001 kg)	160 x 0.05oz	10 x 10 x 4.25"	12"	29 lb
105959	25 x 0.005 lb (10 x 0.002 kg)	400 x 0.1oz	10 x 10 x 4.25"	12"	29 lb
105960	25 x 0.005 lb (10 x 0.002 kg)	400 x 0.1oz	12 x 12 x 4.25"	12"	33 lb
105961	50 x 0.01 lb (25 x 0.005 kg)	800 x 0.2oz	12 x 12 x 4.25"	12"	33 lb
105962	100 x 0.02 lb (50 x 0.01 kg)	1600 x 0.5oz	12 x 12 x 4.25"	12"	33 lb
230VAC CE Marked/OIML Approved					
Part No.	Capacity (enter in kilograms)		Platform Dimensions	Column Height	Est. Ship Weight
106123	3 x 0.001kg		254 x 254 x 108mm	305mm	13.2 kg
106124	6 x 0.002kg		254 x 254 x 108mm	305mm	13.2 kg
106125	15 x 0.005kg		254 x 254 x 108mm	305mm	13.2 kg
106126	15 x 0.005kg		305 x 305 x 108mm	305mm	15 kg
106127	30 x 0.01kg		305 x 305 x 108mm	305mm	15 kg
106128	60 x 0.02kg		305 x 305 x 108mm	305mm	15 kg
230 VAC					
Part No.	Capacity (enter in kilograms (lb) or ounces)		Platform Dimensions	Column Height	Est. Ship Weight
118891	2.5 x 0.0005kg (5lb x 0.001lb)	80 x 0.02oz	10 x 10 x 4.25"	12"	29 lb
118892	5 x 0.001kg (10lb x 0.002lb)	160 x 0.05oz	10 x 10 x 4.25"	12"	29 lb
118893	10 x 0.002kg (25lb x 0.005lb)	400 x 0.1oz	10 x 10 x 4.25"	12"	29 lb
118895	10 x 0.002kg (25lb x 0.005lb)	400 x 0.1oz	12 x 12 x 4.25"	12"	33 lb
118896	25 x 0.005kg (50lb x 0.01lb)	800 x 0.2oz	12 x 12 x 4.25"	12"	33 lb
118897	50 x 0.01kg (100lb x 0.02lb)	1600 x 0.5oz	12 x 12 x 4.25"	12"	33 lb

Table 11-1. CW-90 Specifications



American Style Plug used on 115 VAC and 230 VAC



European Style Plug used on 230VAC CE Marked/OIML Approved

115VAC					
Part No.	Capacity (enter in pounds (kg) or ounces)		Platform Dimensions	Column Height	Est. Ship Weight
105963	5 x 0.001 lb (2.5 x 0.0005 kg)	80 x 0.02oz	10 x 10 x 4.25"	12"	29 lb
105965	10 x 0.002 lb (5 x 0.001 kg)	160 x 0.05oz	10 x 10 x 4.25"	12"	29 lb
105966	25 x 0.005 lb (10 x 0.002 kg)	400 x 0.1oz	10 x 10 x 4.25"	12"	29 lb
105967	25 x 0.005 lb (10 x 0.002 kg)	400 x 0.1oz	12 x 12 x 4.25"	12"	33 lb
105968	50 x 0.01 lb (25 x 0.005 kg)	800 x 0.2oz	12 x 12 x 4.25"	12"	33 lb
105969	100 x 0.02 lb (50 x 0.01 kg)	1600 x 0.5oz	12 x 12 x 4.25"	12"	33 lb
230VAC CE Marked/OIML Approved					
Part No.	Capacity (enter in kilograms)		Platform Dimensions	Column Height	Est. Ship Weight
106129	3 x 0.001kg		254 x 254 x 108mm	305mm	13.2 kg
106130	6 x 0.002kg		254 x 254 x 108mm	305mm	13.2 kg
106131	15 x 0.005kg		254 x 254 x 108mm	305mm	13.2 kg
106132	15 x 0.005kg		305 x 305 x 108mm	305mm	15 kg
106133	30 x 0.01kg		305 x 305 x 108mm	305mm	15 kg
106134	60 x 0.02kg		305 x 305 x 108mm	305mm	15 kg
230 VAC					
Part No.	Capacity (enter in kilograms (lb) or ounces)		Platform Dimensions	Column Height	Est. Ship Weight
118899	2.5 x 0.0005kg (5lb x 0.001lb)	80 x 0.02oz	10 x 10 x 4.25"	12"	29 lb
118900	5 x 0.001kg (10lb x 0.002lb)	160 x 0.05oz	10 x 10 x 4.25"	12"	29 lb
118901	10 x 0.002kg (25lb x 0.005lb)	400 x 0.1oz	10 x 10 x 4.25"	12"	29 lb
118902	10 x 0.002kg (25lb x 0.005lb)	400 x 0.1oz	12 x 12 x 4.25"	12"	33 lb
118903	25 x 0.005kg (50lb x 0.01lb)	800 x 0.2oz	12 x 12 x 4.25"	12"	33 lb
118904	50 x 0.01kg (100lb x 0.02lb)	1600 x 0.5oz	12 x 12 x 4.25"	12"	33 lb

Table 11-2. CW-90X Specifications



American Style Plug used on 115 VAC and 230 VAC



European Style Plug used on 230VAC CE Marked/OIML Approved

Power - AC

Line Voltages 115 or 230 VAC
 Frequency 50 or 60 Hz
 Power Consumption 1.5 A @ 115 VAC (8W)
 0.75 A @ 230 VAC (8W)
 Fusing 2.5 A 5 x 20 mm fuse

Power - DC

Line Voltages 9-36 VDC DC Input
 Power Consumption 1.5 A Max
 Fusing Internal short circuit protection

Analog Specifications

Full Scale Input Signal Up to 22.5 mV
 Excitation Voltage +5V single sided
 8 x 350Ω or 16 x 700Ω load cells
 Sense Amplifier Differential amplifier with
 4- and 6-wire sensing

Analog Signal

Analog Signal Input Range -0.5 mV/V to +4.5 mV/V
 Sensitivity 0.3 μV/graduation minimum,
 1.5 μV/grad recommended
 Input Impedance 200 MΩ, typical
 Noise (ref to input) 0.3 μV p-p with digital filters at 4-4-4
 Internal Resolution 8,000,000 counts
 Display Resolution 100 000 dd
 Measurement Rate Up to 60 measurements/sec
 Input Sensitivity 10 nV per internal count
 System Linearity Within 0.01% of full scale
 Zero Stability 150 nV/°C, maximum
 Span Stability 3.5 ppm/°C, maximum
 Calibration Method Software, constants stored in EEPROM
 Common Mode Voltage -2.35 to +3.45 V, referred to ground
 Rejection 130 dB minimum @ 50 or 60 Hz
 Normal Mode Rejection 90 dB minimum @ 50 or 60 Hz
 Input Overload ± 12 V continuous, static discharge protected
 RFI Protection Signal, excitation, and sense lines protected by
 capacitor bypass

Serial Communications

Port 1 Full duplex RS-232
 Port 2 Full duplex RS-232
 Output only active 20 mA current loop
 Port 3 Optional Ethernet, USB, or fiber optic card
 Operator Interface
 Display 6-digit LED display. 14-segment, 0.8" (20 mm)
 digits
 LED annunciators Center of zero, gross, net, tare, preset tare;
 percent, kg, g, lb, oz
 Keypad 21-key flat membrane panel (CW-90)
 Piezo membrane panel (CW-90X)

Environmental

Operating Temperature -10 to +40°C (legal);
 -10 to +50°C (industrial)
 Storage Temperature -25 to +70°C
 Humidity 0-95% relative humidity

Enclosure

Enclosure Dimensions 9.5 x 6 x 3.12" (24.13 x 15.24 x 7.93 cm)
 Weight 6.1 lb (2.8 kg)
 Rating/Material UL Type 4X

Certifications and Approvals



CW-90/90X Indicator
 CoC Number 08-092
 Accuracy Class III/IIIL n_{max} :10 000
CW-90/90X Scale
 CoC Number 95-072A2
 Accuracy Class III n_{max} :5 000



File Number E151461-A7



Visit www.nsf.org and search by manufacturer.
 Or visit the direct link at:
<http://www.nsf.org/Certified/food/Listings.asp?CompanyName=Rice+Lake%25&>



Certificate No. R76/2006-GB1-10.02



Approval No. AM-5710



Radio certificate number:
 • US: R68WIPORTG
 • Canada: 3867A-WIPORTG



© Rice Lake Weighing Systems Specifications subject to change without notice.
Rice Lake Weighing Systems is an ISO 9001 registered company.

230 W. Coleman St. • Rice Lake, WI 54868 • USA

U.S. 800-472-6703 • Canada/Mexico 800-321-6703 • International 715-234-9171 • Europe +31 (0)26 472 1319