

Counterpart[®]

Configurable Counting Indicator

User Manual



© Rice Lake Weighing Systems. All rights reserved.

Rice Lake Weighing Systems® is a registered trademark of
Rice Lake Weighing Systems.

All other brand or product names within this publication are trademarks or
registered trademarks of their respective companies.

All information contained within this publication is, to the best of our knowledge, complete and
accurate at the time of publication. Rice Lake Weighing Systems reserves the right to make
changes to the technology, features, specifications and design of the equipment without notice.

The most current version of this publication, software, firmware and all other product
updates can be found on our website:

www.ricelake.com

Revision History

This section tracks and describes manual revisions for awareness of major updates.

Revision	Date	Description
H	March 14, 2023	Established revision history
I	June 14, 2024	Updated various terminology and added SINGLEID command to Feature Commands table

Table i. Revision Letter History



Technical training seminars are available through Rice Lake Weighing Systems. Course descriptions and dates can be viewed at www.ricelake.com/training or obtained by calling 715-234-9171 and asking for the training department.

Contents

1.0	Introduction	7
1.1	Safety	7
1.2	Standard Features	7
1.3	Capacities and Resolutions	8
1.4	Modes of Operation	8
1.4.1	Description of Modes of Operation	8
1.5	Keypad Functions	8
1.6	Tare Recall	10
1.7	Annunciator Symbols	10
1.8	How to Use AlphaNumeric Keypad	10
1.9	Softkey Configuration	10
1.9.1	Softkey Setup	11
2.0	Installation	13
2.1	Unpacking	13
2.2	Scale Base Assembly	13
2.2.1	Locking and Unlocking - S-XL Scale Base	13
2.2.2	Locking and Unlocking - S-YC Scale Base	14
2.2.3	Leveling	14
2.3	Enclosure Disassembly	15
2.4	Cable Assembly Instructions	15
2.5	Making Power Connections	16
2.6	Load Cell Wiring	16
2.6.1	Dual Channel Units (S-XD Base)	16
2.6.2	Dual Channel – Remote Scale Setup	17
2.7	Wire Specifics	17
2.8	Cable Grounding	17
2.8.1	Serial Communications	18
2.8.2	Digital I/O	18
2.8.3	Network Connection to Counterpart	19
2.9	Enclosure Reassembly	19
2.10	CPU Board Removal	19
2.11	CPU Board Battery Replacement	19
2.12	Field Installation of DC Battery Pack	20
2.13	Installing Option Cards	21
2.13.1	USB Option Card Installation	23
2.14	Bracket Assembly Connecting Indicator to Scale Base	23
2.15	Indicator Replacement Parts and Assembly Drawings	25
3.0	Configuration	28
3.1	Front Panel Configuration	28
3.2	Menu Navigation	28
3.3	Revolution Configuration	29
3.4	ID Menu	30
3.5	Audit Menu	31
3.6	Calibration Menu	31
3.7	Setup Menu	32
3.7.1	Scale Menu	33



Rice Lake continually offers web-based video training on a growing selection of product-related topics at no cost. Visit www.ricelake.com/webinars

3.7.2	Feature Menu	38
3.7.3	Serial Menu	45
3.7.4	Ethernet Menu	47
3.7.5	Print Format Menu	48
3.7.6	Scale Setpoints Menu	49
3.7.7	DIG I/O Menu	53
3.7.8	Version Menu	54
3.8	Test Menu	54
3.9	Display Menu	55
3.10	Setpoints – Weigh Mode Parameter Menu	56
4.0	Calibration	58
4.1	Front Panel Calibration	58
4.2	Five-point Linearization	59
4.3	Rezero	59
4.4	EDP Command Calibration	59
4.5	Revolution Calibration	60
4.6	More About Calibration	60
4.6.1	Adjusting Final Calibration	60
5.0	Scale Operations	61
5.1	Weight Unit Switching	61
5.2	Entering Tare Weights	61
5.2.1	One-Touch Tare, Tare Unknown	61
5.2.2	Digital Tare, Tare Weight Known	61
5.3	Toggling Between Gross and Net	62
5.4	Entering Unit Weights	62
5.4.1	Unit Weight Operation by Sampling	63
5.4.2	Unit Weight Operation by Key Entry	63
5.5	Negative Counting (Full Box Counting)	64
5.5.1	Counting Out of a Full Container — See Total Amount Remaining in the Container	64
5.5.2	Negative Counting — Total Removed Displayed at the End	64
5.6	IDs	65
5.6.1	Setting an ID Using the Normal Mode	65
5.6.2	Using a Stored ID	66
5.6.3	Using ID/Codes that are not Stored	66
5.6.4	Clearing an ID	66
5.6.5	Adding an ID From Count Mode	66
5.6.6	Adding an ID Through Revolution	67
5.7	WeighVault	68
5.7.1	Demo Setup of Counterpart and WeighVault	68
5.7.2	Using WeighVault	69
5.8	Totalization	69
5.8.1	Parts Reduction Counts	70
5.9	Accumulate Feature For Weight	71
5.9.1	Printing the Accumulated Total	71
5.9.2	Clearing the Accumulated Total	71
5.10	Inventory Adjustment	71
5.11	Batch Operations	71
5.12	Connecting a Barcode Scanner	73



Technical training seminars are available through Rice Lake Weighing Systems.
 Course descriptions and dates can be viewed at www.ricelake.com/training
 or obtained by calling 715-234-9171 and asking for the training department.

6.0 EDP Commands	74
6.1 Command Set	74
6.1.1 Key Press Commands	74
6.1.2 ID Commands	75
6.1.3 Reporting Commands	75
6.1.4 Clear and Reset Commands	76
6.1.5 Parameter Setting Commands	76
6.1.6 Normal Mode Commands	80
6.1.7 Unique Commands	80
7.0 Print Formatting	81
7.1 Print Formatting Tokens	81
7.2 Customizing Print Formats	84
7.2.1 Using the EDP Port	84
7.2.2 Using the Front Panel	84
7.2.3 Using Revolution	85
7.2.4 Print Label Examples	86
8.0 WLAN Installation Instructions	89
8.1 Enclosure Disassembly	89
8.2 WLAN Card Installation	90
8.3 Antenna Installation with Cover Plate	90
8.4 Antenna Installation with Bushing	91
9.0 Appendix	92
9.1 Error Messages	92
9.2 Using the XE and XEH EDP Commands	93
9.2.1 Using the P EDP Command	93
9.3 Continuous Output (Stream) Format	93
9.4 Demand Output Data Format	94
9.5 Custom Stream Formatting	94
9.6 Digital Filtering	96
9.6.1 DIGFLx Parameters	96
9.6.2 DFSENS and DFTHRHR Parameters	96
9.6.3 Setting the Digital Filter Parameters	97
9.6.4 Audit Trail Support	97
9.7 USB Keyboard Interface	98
9.8 Serial Scale Interface	98
9.9 Regulatory Mode Functions	99
9.10 Regulatory Mode and Legal-for-Trade (LFT)	100
9.10.1 Legal for Trade and Normal Weight Mode	100
9.10.2 Legal for Trade and Totalization Mode	101
9.11 Updating Firmware	102
9.12 Resolutions and Dimensions	103
10.0 Specifications	104



Rice Lake continually offers web-based video training on a growing selection of product-related topics at no cost. Visit www.ricelake.com/webinars

1.0 Introduction

This manual is intended for use by qualified installers and service technicians responsible for installing and servicing the Counterpart counting scale indicator.

Counterpart offers practical solutions for a full range of precision counting applications. A bright LCD display enables operators to view quantities, alphanumeric text messaging, part numbers to verify descriptions and correct part recalled from memory. One hundred and fifty item memory and two RS-232 ports and Ethernet enable Counterpart to provide real-time data collection and position it for the future growth of businesses. Multiple scales can be connected to Counterpart, as well as an RS-232 barcode scanner and external printer. When portability is required, choose the battery operation option of Counterpart with up to 24 hours of continuous use for mobile workstations, outdoor applications, and rental fleets. It's built to withstand transport from one area of the plant to another or from one business to the next. Simply connect a printer via RS-232 for labeling, ticketing or receipt tasks.



Manuals are available from Rice Lake Weighing Systems at www.ricelake.com/manuals

Warranty information is available at www.ricelake.com/warranties

1.1 Safety

Safety Definitions:



DANGER: Indicates an imminently hazardous situation that, if not avoided, will result in death or serious injury. Includes hazards that are exposed when guards are removed.



WARNING: Indicates a potentially hazardous situation that, if not avoided, could result in serious injury or death. Includes hazards that are exposed when guards are removed.



CAUTION: Indicates a potentially hazardous situation that, if not avoided, could result in minor or moderate injury.



IMPORTANT: Indicates information about procedures that, if not observed, could result in damage to equipment or corruption to and loss of data.

General Safety

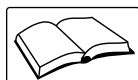

Do not operate or work on this equipment unless this manual has been read and all instructions are understood. Failure to follow the instructions or heed the warnings could result in injury or death. Contact any Rice Lake Weighing Systems dealer for replacement manuals.



WARNING

Failure to heed could result in serious injury or death.

1.2 Standard Features

Counterpart offers a variety of standard features:

- AC operated (battery operation is optional)
- Lb, kg, g, oz weight display conversion
- Single- or dual-channel models with serial scale
- Two RS-232 ports for peripheral connections (with one port also supporting 20 mA transmit)
- Onboard Ethernet capability
- Scanner input (using RS-232 port)
- Revolution software utility for setup
- 150 item memory

1.3 Capacities and Resolutions

Table 1-1 lists the scale capacities and resolutions for all part numbered models of Counterpart.

Counting scales show two types of resolution:

- Weight (or external) resolution
- Counting (or internal) resolution

Weight resolution displays in divisions of the full scale capacity, which is divided into weight increments. For example, a 5 lb scale divided into 10,000 display divisions would display weight with 0.0005 lb divisions (10,000 divisions x 0.0005 lb = 5.0 lb).

Counting resolution is based on the internal resolution of the scale. The default weight and counting resolutions for Counterpart capacities are shown below.

Platform Capacity	Weighing Resolution	Counting Resolution	Platform Dimensions
5.0 lb (2 kg)	0.0005 lb (0.0002 kg)	0.000005	9" x 12"
10 lb (5 kg)	0.001 lb (0.0005 kg)	0.00001	11" x 16"
25 lb (10 kg)	0.002 lb (0.001 kg)	0.00002	
50 lb (20 kg)	0.005 lb (0.002 kg)	0.00005	
100 lb (50 kg)	0.01 lb (0.005 kg)	0.0001	

Table 1-1. Counterpart Capacities

1.4 Modes of Operation

1.4.1 Description of Modes of Operation

- Count Mode – All basic weighing and counting operations are performed
- Setup Mode – Item data can be programmed into the memory of the scale

1.5 Keypad Functions







Key	Function
	Turns Counterpart unit on/off NOTE: If the PC1 jumper is set to SW, the POWER button must be used to turn the unit on and off. If the PC jumper is set to ON, the unit automatically powers on when it's plugged in and the only way to turn it off is to unplug power.
 MENU SETUP	Enters Menu mode, allowing configuration if the Audit jumper is in the ON position; Also used as an escape key in Menu mode
 ZERO →0←	Sets the current gross weight to zero, provided the amount of weight to be removed or added is within the specified zero range and the scale is not in motion; The zero band is defaulted to 1.9% of full scale, but can be configured for up to 100% of full scale NOTE: 1.9% is required for legal-for-trade applications.
 UNIT WEIGHT	Used to enter a known unit weight of a part; Up to 10 characters may be entered including zero
 PRINT	Sends on-demand serial information out the serial port, provided the conditions for standstill are met
 TARE	Performs one of several predetermined Tare functions dependent on the mode of operation selected in the TAREFN parameter; To view a stored tare (Section 1.6 on page 10); Acts as the ENTER key

Table 1-2. Keypad Functions



Key	Function
	Allows the display to change between gross mode and net mode
	Used for computing the unit weight by sampling; Press the SAMPLE key after placing a sample on the platform or after using the numeric keypad to enter the sample size; The default sample size is 10
	Switches the weight display to an alternate unit; The alternate unit is defined in the Setup Menu and could be kg, g, lb, oz
	Clear key; Used to backspace on entries
Alpha-Numeric keypad	Used to enter values directly (Figure 1-1); Press keys for lower and upper case alpha characters

Table 1-2. Keypad Functions (Continued)

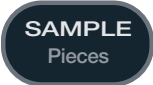

Figure 1-1. Numeric Keypad

Additional Keypad Symbols

Additional symbols can be accessed by pressing the following keys.

Key	Symbol
1	<
	>
	-
	+
	*
	\$
	/
	%
0	*
. (period)	space

Table 1-3. Additional Keypad Symbols

1.6 Tare Recall

When a stored tare displays, Net annunciators turn on. To display a stored tare:

1. Set up a softkey ([Section 1.9.1 on page 11](#)).
2. Press the **DISPLAY TARE** softkey. The tare value displays. If there is no tare in the system, pressing  will have no effect. The Gross/Net annunciators are not lit and a value displays in weight display area.

1.7 Annunciator Symbols









Annunciator	Description
	INSUFF – Insufficient; Scale is at standstill or within the specified motion band; Some operations, including tare functions and printing, can only be done when the standstill symbol is shown
	RECOMP – Recompute; If this annunciator is lit after a Sample operation, additional pieces can be placed on the scale to recompute the unit weight (Section 5.4.1 on page 63)
	BATT – Battery; Indicates the level of the optional DC battery pack
	SCALE – Scale; Displays the current scale
	GROSS – Gross; Gross weight mode (or Brutto in OIML mode)
	NET – Net; Net weight display mode
	ZERO – Zero; While in gross weight display mode, this annunciator indicates that the current displayed weight reading is within ± 0.25 display divisions of the acquired zero, or is within the center of zero band; When in the net weight display mode, it indicates that the current net weight reading is within ± 0.25 display divisions of the center of net zero; A display division is the resolution of the displayed weight value, or the smallest incremental increase or decrease that can be displayed or printed
	M – Totalization memory



Table 1-4. Annunciator Symbols



NOTE: The annunciator LCDs light depending on the scale status.

1.8 How to Use AlphaNumeric Keypad

Counterpart can use alpha characters with numeric characters. Use the following steps to change to alpha characters:

1. Select a key labeled with the value desired.
2. Push until the desired value appears, e.g. 2 abcABC.
3. Move to the next letter and push until that value appears.
4. If the next letter is the same key, push  to move over to the next selection.
5. When complete, push  to save.

1.9 Softkey Configuration

Softkeys offer additional ways to access features associated with Counterpart. To access the softkey setup parameter, go to **Menu/Setup/Config/Feature/Softkeys**.

Select the desired function for each softkey and press  after each entry and then press the **SaveExit** softkey.

To leave a softkey parameter without making changes, press .



NOTE: Softkeys set for either *Display Tare* or *Display Accum* automatically time out and revert to the normal active display after 10 seconds.

1.9.1 Softkey Setup

Basic Counterpart operations are summarized below.

Toggle Gross/Net



Press  to switch display toggle gross and net modes. If a tare value has been entered or acquired, the net value is the gross weight minus the tare. If no tare has been entered or acquired, the display remains in gross mode.

Gross mode and net mode is indicated by the annunciator on the display.



Toggle Units

Press  to switch between primary, secondary, and tertiary units.



Zero Scale

1. While in gross mode, remove all weight from the scale and wait for the standstill annunciator (.
2. Press . The zero annunciator displays to indicate the scale is zeroed.

Acquire Tare

1. Place a container on the scale and wait for the standstill annunciator (.
2. Press  to acquire the tare weight of the container.
3. The **Net** annunciator will be enabled.

Remove Stored Tare Value

1. Remove all weight from the scale and wait for the standstill annunciator (.
2. Press . The display shifts to gross weight and the Gross annunciator displays.



Keyed Tare

1. Key in the value of the container.
2. Press .
3. The **Net** annunciator displays.

Print

Press  to print either the Gross, Net, Total or Count format.

The default format is a 2.25" x 4.5" label.

1. Wait for standstill annunciator (.
2. Press  to send data to the serial port.

If the standstill annunciator is not present, the  command is executed if the scale comes out of motion within three seconds.

Set Date and Time











1. If the **Time/Date** softkey is enabled, push the softkey. The current value displays.
2. To change, use the Up/Down arrows to highlight the value to change.
3. Press  to save and exit.

Set Serial Scale (Scale 3)

1. Select Port 1 — Indust Scale.
2. Match the baud rates. Upon doing this it automatically becomes Scale 3.

Softkey Setup

To set up a softkey, use the following steps:

1. Press .
2. Navigate through the menu setup to Setup using .
3. Press  to navigate to **CONFIG**.
4. Press  to navigate to **SCALES**.
5. Press  to navigate to **FEATURE**.
6. Press  to navigate to **COUNT**.
7. Use  to scroll to **SOFTKEYS**.
8. Scroll down. Then use  and  to scroll through menu selections SK1 through SK12.
9. Press  to assign a softkey to that position.
10. Select a parameter to be displayed.
11. Press  once the function is selected.
12. Press **Save/Exit** softkey.

2.0 Installation

Counterpart is available in different configurations from just the indicator display to the display and counting scale combined together as a unit. This section contains instructions on unpacking and assembly, leveling, making power connections, load cell wiring, wiring standard serial port, optional network communications, wiring optional digital outputs, optional backup battery operation, and power-up sequence. Assembly drawings and replacement parts lists are also included.

! **IMPORTANT:** Do not pick up the counting scale by the “spider” assembly, which supports the platter. Lifting by the spider may damage the load cell. Lift the scale from under the base to move it.

2.1 Unpacking

Counterpart comes with the following components and comes pre-assembled from the factory.

Counterpart Indicator Display

- AC adapter
- This manual
- Indicator head

Scale Base

- Scale base
- Weighing platform
- Bracket assembly

✍ **NOTE:** If purchasing a different scale base, a separate plastic bag with wiring components comes with the scale base but is not needed and can be set aside.

Store the packing material and box in a safe, easily accessible place. To transport the scale across any substantial distance, use the original packing material.

Immediately after unpacking the scale, visually inspect Counterpart to ensure all components are included and undamaged. If any parts were damaged in shipment, notify Rice Lake Weighing Systems and the shipper immediately.

2.2 Scale Base Assembly

✍ **NOTE:** Scale base assembly is only required if purchased separately from the indicator.

! **IMPORTANT:** Do not turn the scale upside down. Always work with the scale on its side. Damage to the load cell can occur if the scale is turned upside down.
Set up the scale on a stable, level surface.

2.2.1 Locking and Unlocking - S-XL Scale Base

The Counterpart S-XL scale base is delivered in a locked position to prevent damage to the load cells during shipment. The scale base uses either one setscrew for the single-platform scale or two setscrews for the dual-platform scale. Setscrews are located on the bottom of the base and must be removed before the scale is put into service. Use the following steps to unlock the scale base:

1. Turn the scale on its side.



Figure 2-2. Location of Load Cell Setscrews for Single and Dual-Platform Scales (DIGI S-XL Scale Base Shown)

2. Remove the load cell setscrew using a hex wrench for the dual platform setscrews or a Phillips head screwdriver for the single platform scale.
3. Tape the setscrews to the bottom of the scale or store in a safe place for possible future use.

2.2.2 Locking and Unlocking - S-YC Scale Base

The Counterpart S-YCL scale base is delivered in a locked position to prevent damage to the load cells during shipment. The scale base uses two setscrews. The setscrews are located on the bottom of the base and must be removed before the scale is put into service. Use the following procedure to unlock the scale base for the S-YC Model.

1. Turn the scale on its side.

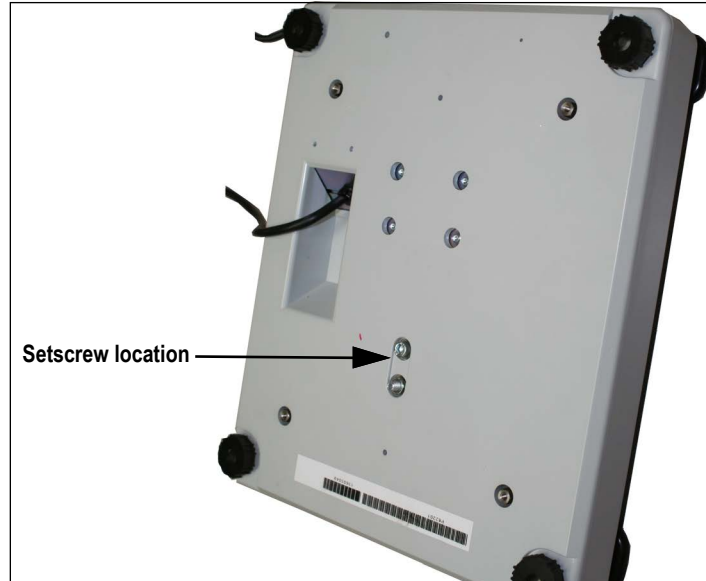

Figure 2-3. Location of Load Cell Setscrew for the DIGI S-YC Scale Base

2. Remove the load cell setscrews using a hex wrench which is included.
3. Tape the setscrews to the bottom of the scale or store in a safe place for possible future use.

2.2.3 Leveling

Select a location for the Counterpart that is level and free of vibrations and air currents. Adjust the four corner feet on the scale base and refer to the bubble level on the inside frame. The base should not rock and the feet should have solid contact with the surface.



NOTE: Ensure the nut on each foot's bolt is secured flush against the scale base.

To ensure greater scale stability, turn in all four adjustable legs before leveling. Turn out adjustable legs to level as needed.



Figure 2-4. Adjust the Scale Base Feet

2.3 Enclosure Disassembly

Counterpart indicator enclosure must be opened to connect cables for load cells, communications and digital inputs/outputs.



Warning: Before opening the unit, ensure the unit is turned off and the power cord is disconnected from the power outlet. The power outlet must be located near the indicator to allow the operator to easily disconnect power to the unit.

Ensure power to the indicator is disconnected, then place the indicator on an anti-static mat. Remove the four screws holding the top plate to the enclosure body and set them aside. Gently lift the top plate away from the enclosure and disconnect any cables and set aside.

2.4 Cable Assembly Instructions

The indicator comes with five removable openings for running cabling through. The user can open as many as needed and can easily remove them by using needle-nose pliers as shown in [Figure 2-5](#).

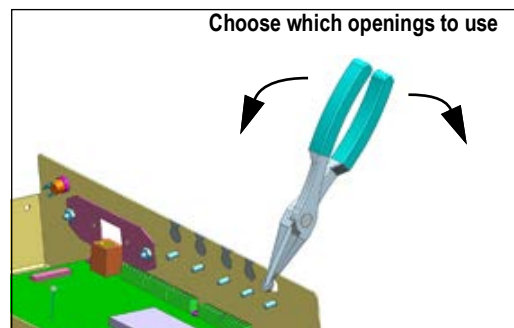

Figure 2-5. Removable Openings

Use the following steps to open and install cable assemblies.

1. Open the cover assembly by removing the four screws (only one shown in [Figure 2-6](#)).
2. Run the appropriate cable(s) through the desired opening(s).
3. Thread the plastic split bushing (found in the parts kits contents) onto the cable with the smallest diameter facing towards the enclosure and the split opening facing downwards.
4. Replace the cover assembly and tighten using the four screws.
5. Push the plastic bushing all the way into the enclosure to make a tight seal in the hole.

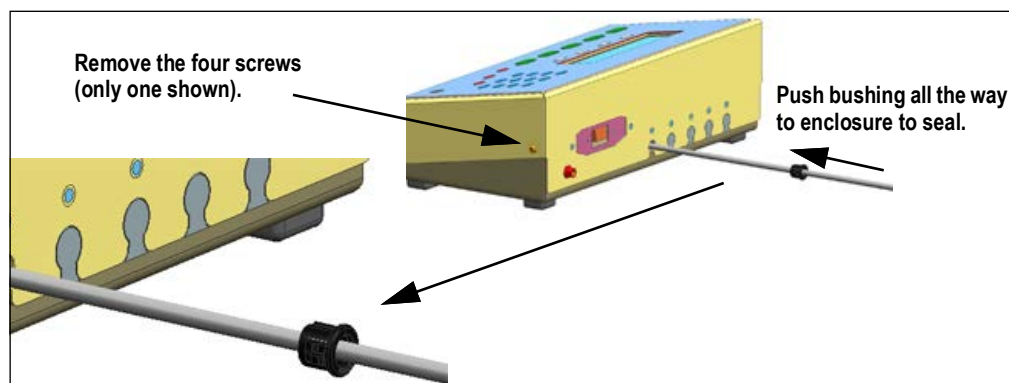

Figure 2-6. Use Plastic Bushings



IMPORTANT: Bushings are not a cord grip. Bushings allow for free movement of cable while protecting them from the enclosure sides.

2.5 Making Power Connections

The power source used for the Counterpart must be properly grounded to an acceptable earth ground and the outlet must be a grounded outlet. If the scale is remotely mounted, the platform must be separately grounded from the chassis ground screw located on the bottom of the platform. Connect this screw with 18 gauge wire to the same earth ground system as the AC power source. Failure to ground the base may cause static buildup that could cause damage to the electronics and/or give incorrect weight readings.

The AC adapter plugs in and turns to lock to the unit. [Figure 2-7](#) shows the AC power location.



Figure 2-7. AC Power Location

2.6 Load Cell Wiring

On all complete units, the load cell has been wired to the CPU load cell terminal at the factory. Wire the cable to the CPU board's J1 and J2 connector as shown in [Table 2-5](#).



NOTE: If using a 4-wire connection, set J1 and J2 to ON. If using a 6-wire connection, set J1 and J2 to OFF.

J1 and J2	Function
1	+ Signal
2	- Signal
3	+ Sense
4	- Sense
5	+ Excitation
6	- Excitation

Table 2-5. J1 and J2 Pin Assignments

2.6.1 Dual Channel Units (S-XD Base)

For units that have dual channels, connect cable from the 14 pin connector to J1 and J2. If not using a dual base, remove the J2 connector as shown in [Figure 2-9 on page 17](#). Trim back the wires and tape.

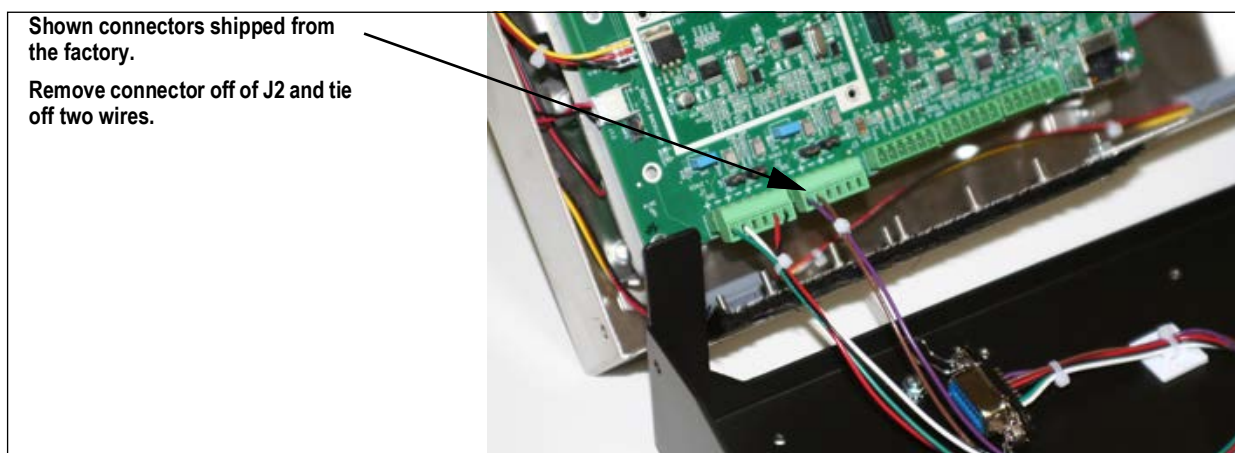

Figure 2-8. J2 Connector Location

2.6.2 Dual Channel – Remote Scale Setup

Use the following steps for units that have dual channels and want to set up a scale remotely.

1. Remove the connector from the parts bag (included).
2. Wire per the load cell wiring code.
3. Plug into the J2 connector on the CPU board (Figure 2-8 on page 16).
4. Set up the softkey - Scale Select (Section 3.7 on page 32).

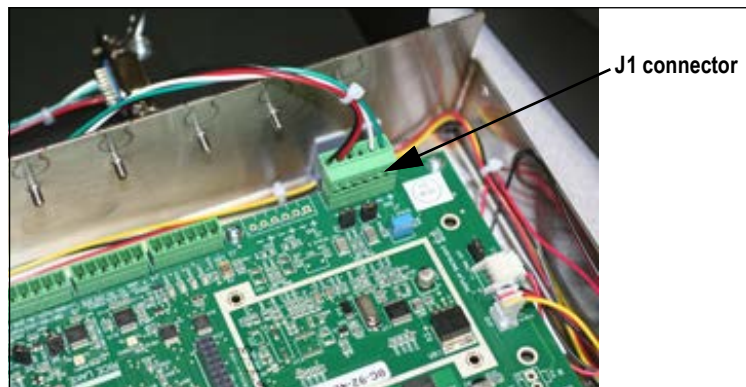

Figure 2-9. Remove J2 Connector if Using Single Base Scale or Only Single Base on a Dual Base

2.7 Wire Specifics

Wires connecting to J1, J2, J3, or J4 should adhere to the following specifications:

Wire Range	Wire Strip Length
28~12 AWG stranded or solid wire	5~6 mm (3/16 in ~ 1/4 in)

Table 2-6. Wire Specifications for Connectors

2.8 Cable Grounding

Except for the power cord, all cables should be grounded against the scale enclosure. Do the following to ground shielded cables.

- Use the lockwashers, clamps, and keps nuts provided in the parts kit to install grounding clamps on the enclosure studs. Install grounding clamps that will be used; Do not tighten nuts
- Route cables and grounding clamps to determine cable lengths required to reach cable connectors; Mark cables to remove insulation and shield as described below
- For cables with foil shielding, strip insulation and foil from the cable half an inch (15 mm) past the grounding clamp (Figure 2-10); Fold the foil shield back on the cable where the cable passes through the clamp; Ensure silver (conductive) side of foil is turned outward for contact with the grounding clamp
- For cables with braided shielding, strip cable insulation and braided shield from a point just past grounding clamp; Strip another 1/2" (15 mm) of insulation only to expose the braid where cable passes through clamp (Figure 2-10)
- Finish installation using cable mounts and ties to secure cables inside of indicator enclosure

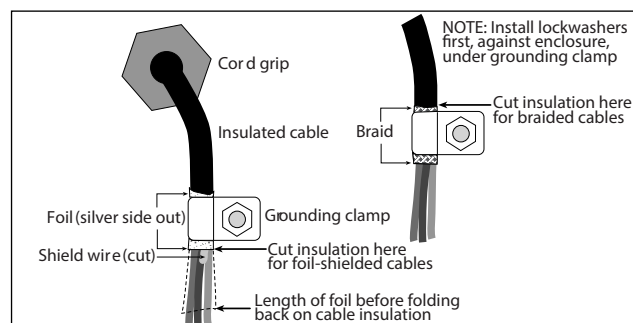

Figure 2-10. Grounding Clamp Attachment for Foil-Shielded and Braided Cabling

2.8.1 Serial Communications

Wire the serial communications cables to J4, which is Port 1 (20 mA). J5 is Port 2 (RS-232). Connect communications cables to J5 and J4 as shown in [Table 2-7](#).

Use cable ties to secure serial cables to the inside of the enclosure.

Port 1 supports full duplex RS-232 communications only; Port 2 provides either active 20 mA output or duplex RS-232 transmission. Both ports are configured using the SERIAL menu ([Section 3.7.3 on page 45](#)).

Connector	Pin	Signal	Port
J4	1	+20 mA	2
	2	Ground or -20 mA	
	3	Tx	
	4	Rx	
	5	CTS	
	6	RTS	
J5	1	Ground	1
	2	Ground	
	3	Tx	
	4	Rx	
	5	DTR	
	6	RTS	

Table 2-7. Serial Communication Wiring



NOTE: An additional port (Port 3) is available if needed through the installation of an option card at J14.

2.8.2 Digital I/O

The Digital I/O can be configured as either digital inputs or digital outputs as determined by the Digital I/O menu ([Section 3.7.3 on page 45](#)). The inputs are active (on) with low voltage (0 VDC) and can be driven by TTL or 5 V logic without additional hardware. Use the Digital I/O menu ([Section 3.7.3 on page 45](#)) to configure the digital inputs. LEDs on the CPU board light when digital inputs are active ([Figure 2-11 on page 19](#)).

Digital outputs are typically used to control relays that drive other equipment. Outputs are designed to sink not source, switching current. Each output is a CMOS circuit, capable of sinking 24 mA when active. Digital outputs are wired to switch relays when the digital output is active (low, 0 VDC) with reference to 5 VDC supply. LEDs on the CPU board light up when the digital outputs are active ([Figure 2-11 on page 19](#)).

Connector	Pin	Signal
J3	1	+5V
	2	Ground
	3	DIG I/O 1
	4	DIG I/O 2
	5	DIG I/O 3
	6	DIG I/O 4

Table 2-8. J3 Pin Assignments (Digital I/O)

2.8.3 Network Connection to Counterpart

Counterpart has an onboard Ethernet connection. Its wireless connectivity is made possible with the optional Lantronix® wireless networking device (PN 125495). For installation and configuration instructions, refer to [Section 8.0 on page 89](#) and WLAN Installation Instructions (PN 206460) included with the option card.

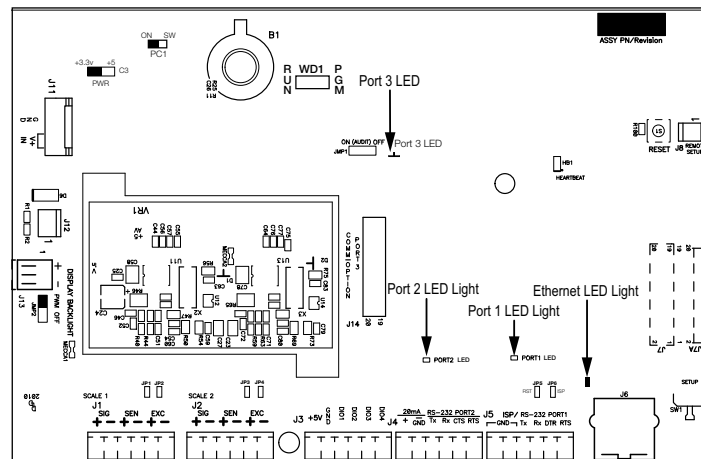

Figure 2-11. LED Light Locations



NOTE: The Ethernet LED light is on when connected at 100 mb/s and is off when connected at 10 mb/s.

2.9 Enclosure Reassembly

Once the cabling is complete, position the top plate over the enclosure and reinstall the four screws.

2.10 CPU Board Removal

To remove the Counterpart CPU board, use the following procedure:

1. Disconnect power to the scale.
2. Disconnect power supply cable from connector J12 on the Counterpart CPU board.
3. Disconnect the wires at the following connectors: J1, J2, J3, J4 and J5 and J13 if equipped.
4. Remove the six screws connecting the CPU board and then lift the board out of the enclosure.

To replace the CPU board, reverse above procedure. Ensure to reinstall cable ties to secure cables inside indicator enclosure.

2.11 CPU Board Battery Replacement



CAUTION: Risk of explosion exists if battery is replaced with incorrect type. Dispose of batteries according to federal, state and local regulations.

The lithium battery on the CPU board maintains the real-time clock and protects data stored in the system RAM when the indicator is not connected to AC power. Data protected by this battery includes time and date, IDs, buffered WeighVault transaction data and setpoint value data. If any data is lost, the indicator configuration can be restored from the PC. Watch for the low battery warning on the LCD display and periodically check the battery voltage on the CPU board. Batteries should be replaced when the indicator low battery warning comes on, or when battery voltage falls to 2.2 VDC. Life expectancy of the battery is 7 years. Use Revolution to store a copy of the configuration before attempting to replace the battery.

For best results, replace the battery while in weigh mode and with AC power applied. Use care not to bend the battery retaining spring. The battery location on the CPU board is shown in [Figure 2-15 on page 22](#) as B1.

2.12 Field Installation of DC Battery Pack

An optional DC battery pack (PN 124692) for Counterpart is available and can be purchased from Rice Lake Weighing Systems to ship with the scale or retrofit in the field. The rechargeable 7.4 V battery pack allows for more than 24 hours of continuous use without an AC power supply.

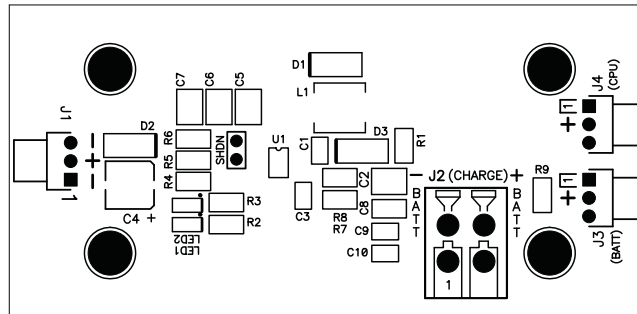

Figure 2-12. Battery Pack CPU Board

The battery pack can be installed next to the CPU board of Counterpart. Use the following procedure to install or replace the battery pack.

1. Disconnect power from the scale prior to opening.
2. If the indicator is connected to scale base, disassemble and set scale base aside.
3. Place the indicator on an anti-static mat.
4. Remove the four screws holding the top plate to the enclosure body and set them aside.
5. Gently lift the top plate away from the enclosure and disconnect any cables and set it aside.
6. Using the supplied nuts, secure battery pack to enclosure using a 5/16 in nut driver.

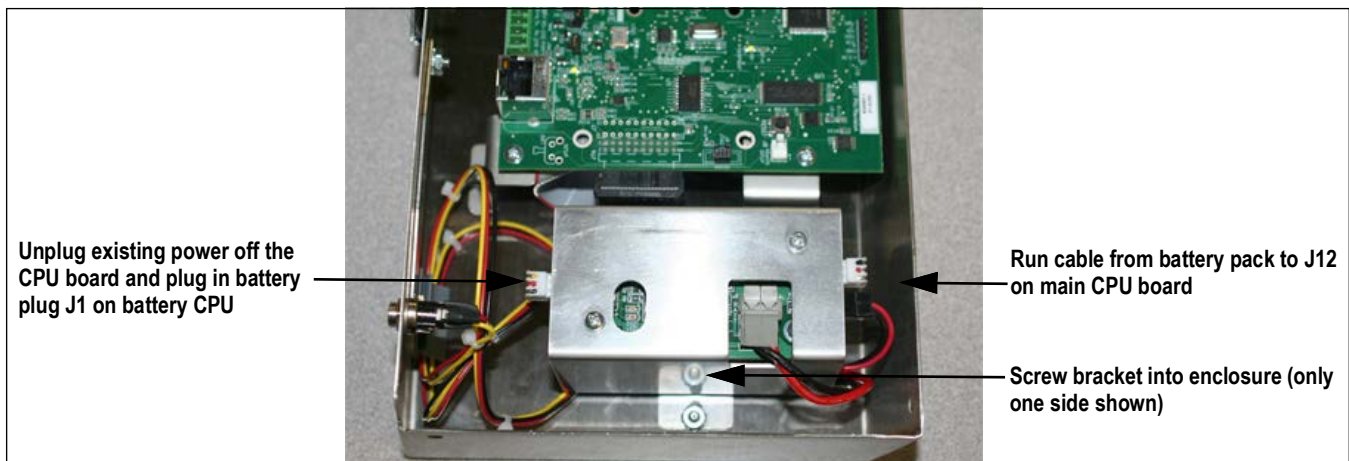

Figure 2-13. Secure Battery Pack into Enclosure

7. Run cable over to power plug J12 on the Counterpart CPU board.



Figure 2-14. Connect Power Plug onto J12 on CPU Board

8. Unplug existing power off the CPU board and plug in battery plug J1 on battery CPU.
9. AC plugs into the back of the unit.



NOTE: Red and green LEDs located on the battery CPU board tell the user whether the battery is fully charged or not.

2.13 Installing Option Cards

Disconnect power cord before installing option cards.



NOTE: Ethernet port is not suitable for connection to circuits used outside the building and is subject to lightning or power faults.

Each option card is shipped with installation instructions specific to that card. For specific instructions on the WLAN card, refer to [Section 8.0 on page 89](#).

The general procedure for all option cards is:

1. Disconnect power cord from the scale.
2. Install the plastic standoffs in the standoff holes.
3. Carefully align the option card connector with the J14 connector on the CPU board.
4. Press down firmly to seat the option card in the CPU board connector.

- Make connections to the option card as required. Use cable ties to secure loose cables inside the enclosure. When installation is complete, reassemble the enclosure as described in [Section 2.9 on page 19](#).

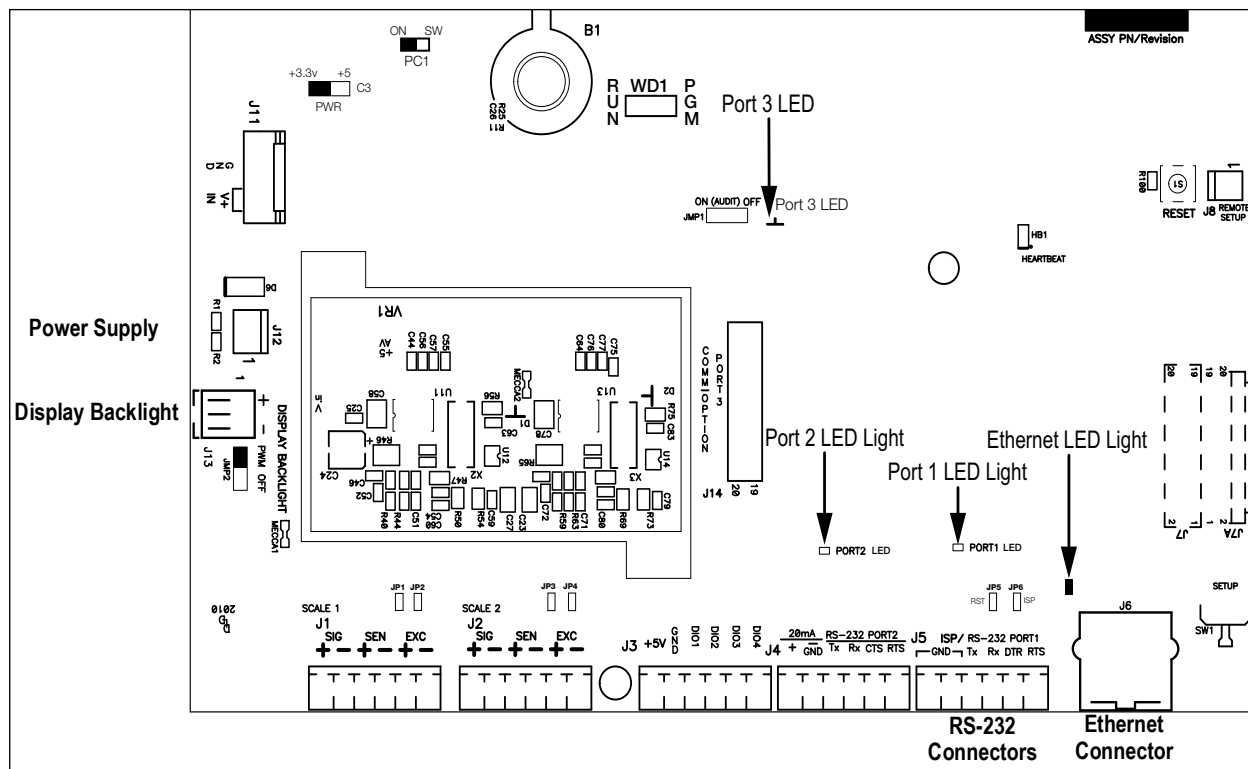

Figure 2-15. CPU Board

Jumper	Description
JP1/JP2 JP3/JP4	Jump excitation to sense; If using a 4-wire load cell cable (JP3 and JP4 for scale number 2), leave JP1 and JP2 on; If using a 6-wire load cell cable, take JP1 and JP2 off; Default is ON
JP5/JP6	Used when upgrading firmware; The jumpers should be on when upgrading firmware and off when the update is complete
PC 1	Power control; If the jumper is set to SW, the POWER key can be used to turn the unit on/off; If set to ON, the unit will power on when plugged in and can only be powered off by unplugging
JMP2	Set display backlight setting jumper to the OFF position which turns off the backlight
AUDIT JMP1	If set to Audit ON, calibration and configuration can be accessed through the front keypad using the MENU SETUP key; If set to Audit OFF, calibration and configuration can only be accessed by removing the screws from the unit and placing the jumper in the ON position
PWR	+3.3V/5V Factory use only – Leave in 3.3 V position

Table 2-9. Jumper Descriptions



NOTE: If the **RESET** button on the CPU board is pressed, the scale will perform a reboot.

Jumper **WD1** is located next to **B1** battery on the CPU board. Put the jumper to **PGM** for programming mode only and move the jumper to **RUN** position for normal operation.

For backlit display to function properly, jumper **JMP2** should be set to **PWM** and jumper **PWR** should be set to 3.3 V.

2.13.1 USB Option Card Installation

Use the following steps to install the USB option card:

1. Disconnect power cord from the scale.
2. Install the plastic standoffs in the standoff holes.
3. Carefully align the option card connector with the J14 connector on the CPU board ([Figure 2-14 on page 21](#)).
4. Press down firmly to seat the option card in the CPU board connector.

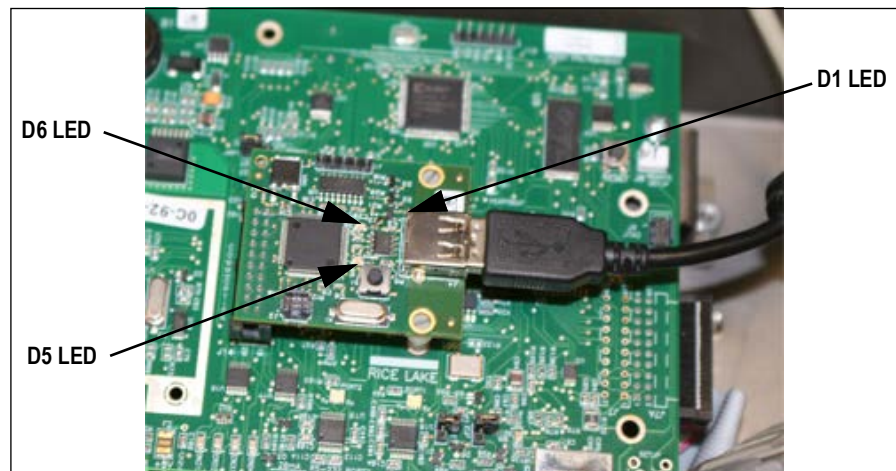

Figure 2-16. Installing the USB Option Card

5. Several signal LEDs are located on the USB option board as shown in [Figure 2-16](#).
 - D5 – When flashing, it indicates that a keyboard is connected and has been detected
 - D6 – Lit continuously when the option board is waiting for a keyboard to be connected; Off when a keyboard is connected
 - D1 – Indicates that there is communication with the main CPU board; It should flicker for each keypress on the attached keyboard



NOTE: USB option is for USB keyboard only.

2.14 Bracket Assembly Connecting Indicator to Scale Base

The Counterpart scale comes with an easy bracket assembly that conveniently hooks the indicator head to the scale base. There are two bracket assemblies that can be used to attach the indicator to the scale base depending on which scale base is being used.

- DIGI S-XL base bracket assembly kit part number (PN 121459)
- DIGI S-YC base bracket assembly kit part number (PN 154700)

The associated assembly is found in the scale base box and is shown below.



Figure 2-17. Bracket Assembly Kit for the Counterpart Scale Base

Use the following steps to attach the indicator to the scale base:



CAUTION: Do not turn the scale upside down. Always work with the scale on its side. Damage to the load cell can occur if the scale is turned upside down.

1. Stand the scale base on its side to attach the bracket to the scale using the screws provided in the bracket kit.
2. Ensure the cable underneath the scale base is threaded through the opening between the scale and the bracket, otherwise it will not fit (Figure 2-18 and Figure 2-19).

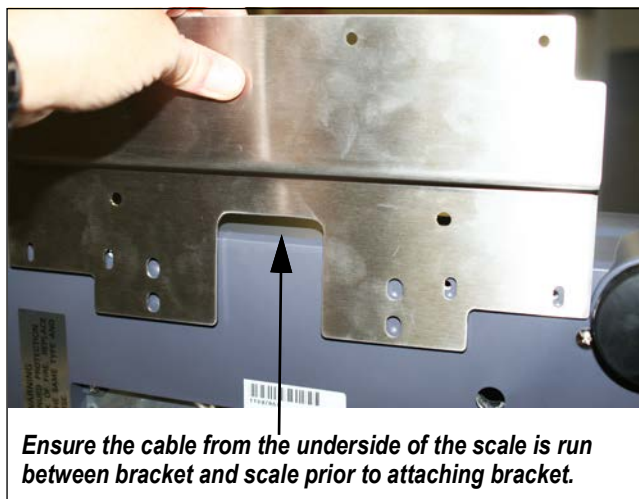

Figure 2-18. Attach Bracket Assembly to Scale Base While Scale Is Tipped on its Side (DIGI S-XL Base Shown)

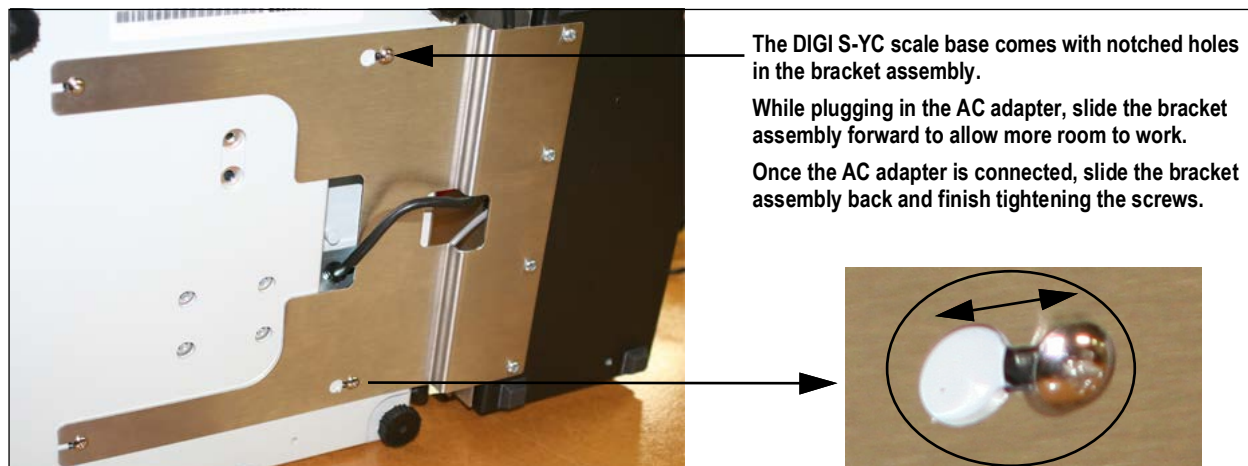

Figure 2-19. Attach Bracket Assembly to DIGI S-YC Scale Base

3. Set scale base down on a flat surface positioning the bracket assembly at the edge of a table.
4. Attach the indicator to the bracket using the second set of screws provided and screw white threaded standoffs into indicator base as in Figure 2-20 if using the S-YC scale base and then screw feet into the bottom of the standoffs.



Figure 2-20. Indicator Attached to the Scale Base (DIGI S-YC Scale Base Shown)

2.15 Indicator Replacement Parts and Assembly Drawings

Item No.	Part No.	Description	Qty.
1	118434	Overlay, Membrane Switch Panel	1
2	118435	Counterpart Cover Enclosure	1
3	120756	Seal Strip, Nylon Brush w/ Holes	1
4	124625	Adapter, AC Wire	1
5	119275	LCD Display Module	1
6	14848	Screw, Phillips Head 6-32NC x 3/8	4
7	120484	CPU Mounting Bracket	1
8	14621	Keyp Nut, 6-32NC Hex	6
9	120741	CPU Board Single AD	1
	117507	CPU Board Dual AD	1
10	14822	Machine Screw, 4-4 ONC x 1/4	6
11	118437	Enclosure Base	1
12	19433	Rubber Foot	4
13	60130	Ribbon Cable	1
14	75146	Coverplate	1
15	120266	Machine Screw, 6-32NC x 3/8	4
16	69291	Lithium Battery, 3 V	1
17	59274	#6 Flat Washer	1
18	56972	Flat Cable Clamp	2
-	128063	Power Supply Assembly	1

Table 2-10. Counterpart Indicator Replacement Parts



Figure 2-21. Counterpart Front View

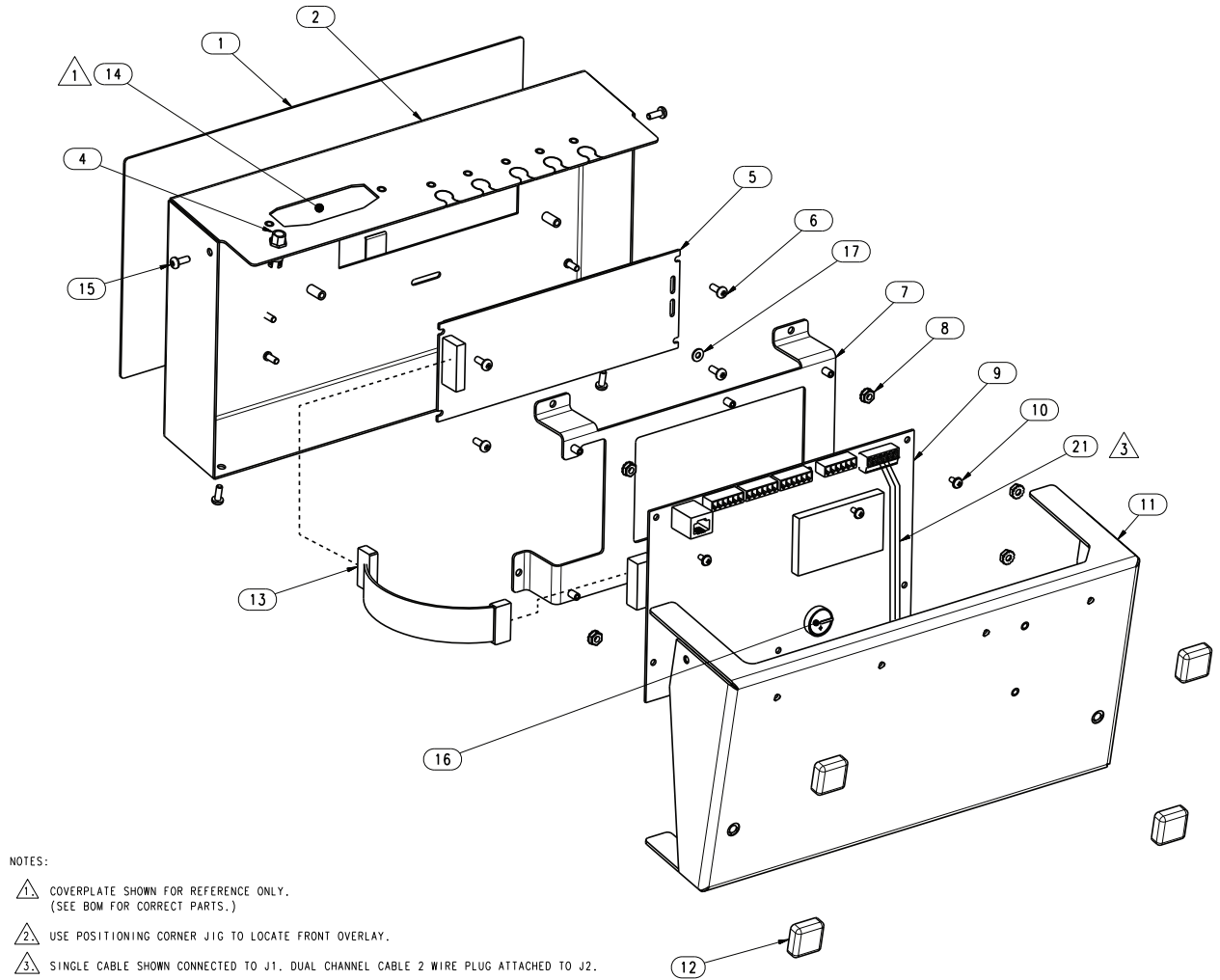

Figure 2-22. Counterpart Assembly and Components

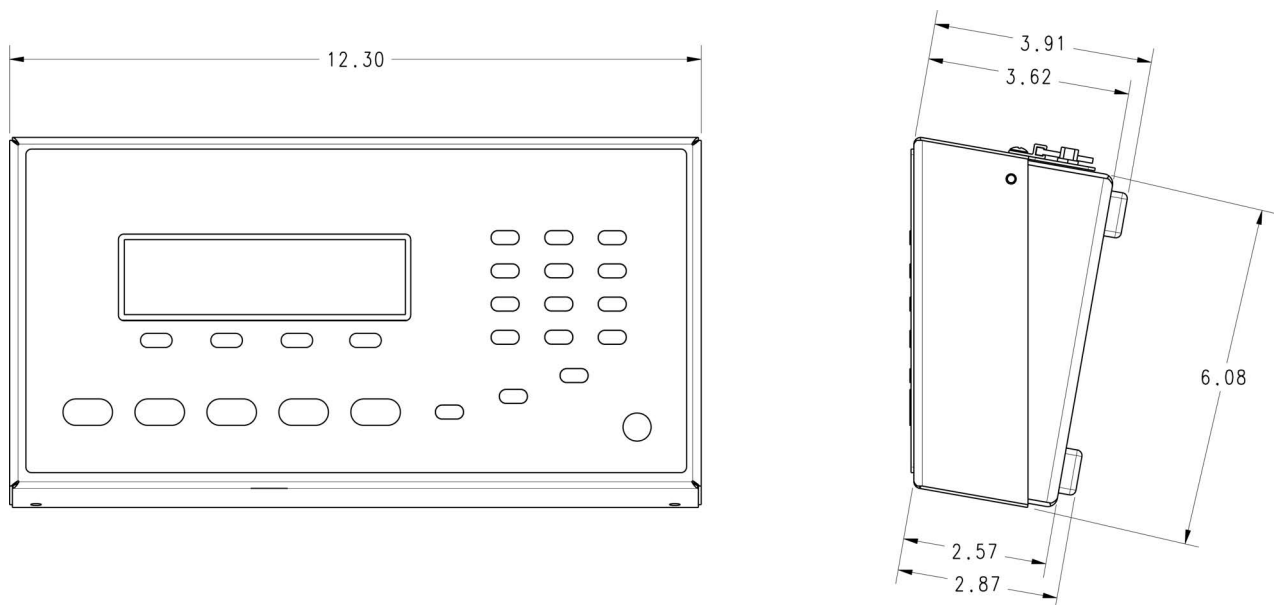

Figure 2-23. Counterpart Dimensions

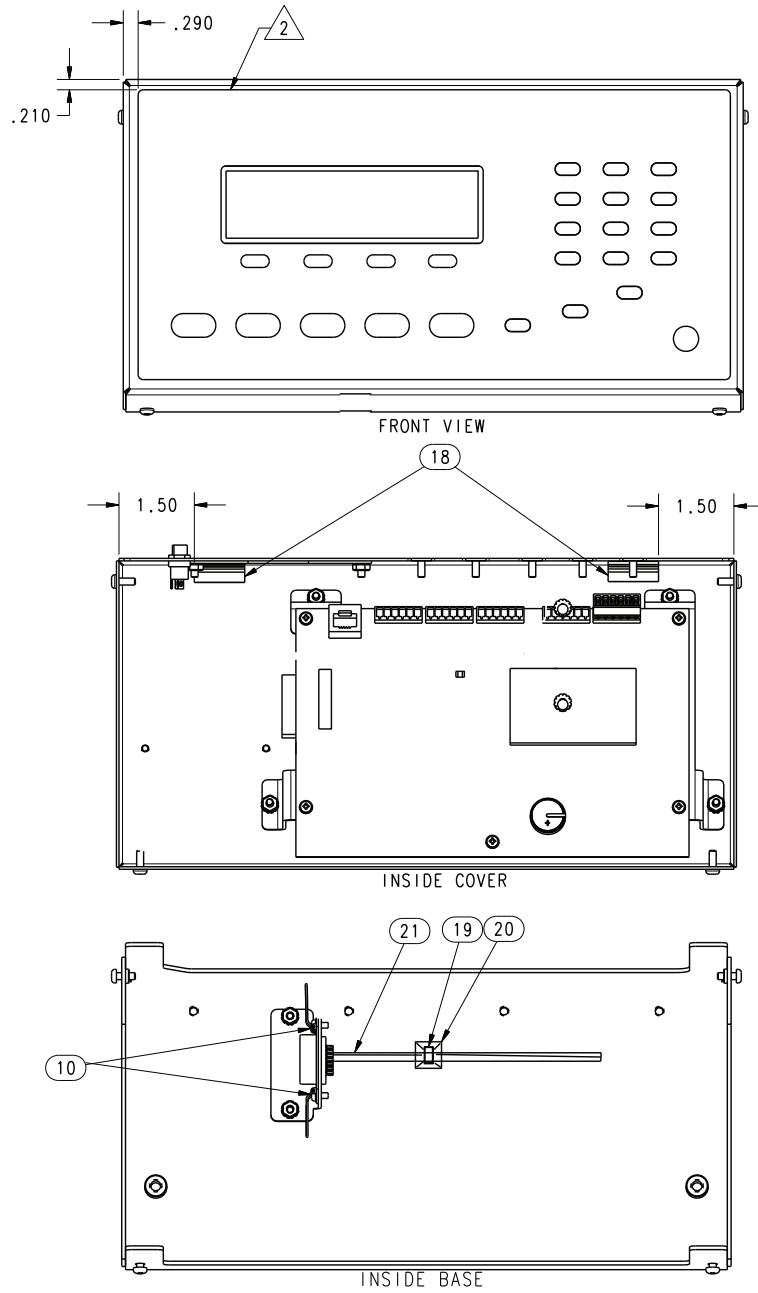

Figure 2-24. Counterpart Rear and Side Dimensions

3.0 Configuration

The Counterpart scale can be configured using a series of menus accessed through the scale front panel when the scale is in setup mode. Figure 3-1 and Table 3-1 summarizes the functions of each of the top level menus.

 **NOTE:** To navigate through the menus, use the front panel keys and shown in Section 3.2.

3.1 Front Panel Configuration

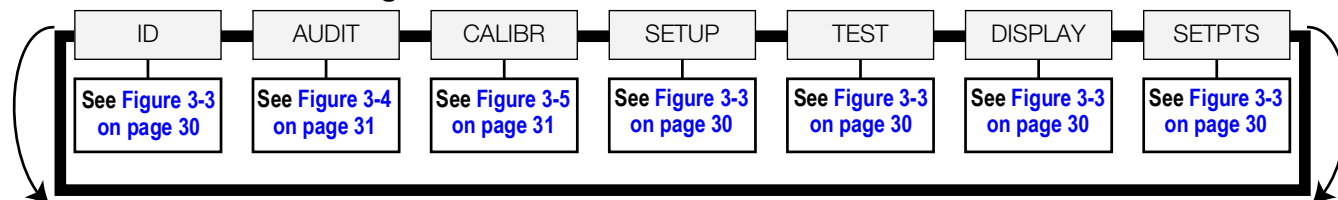

Figure 3-1. Menu Mode Navigation Structure







Menu		Description
ID	ID	Allows for setup or edit IDs
AUDIT	Audit Trail	Displays the legally relevant (LR) firmware version, configuration count, and calibration count
CALIBR	Calibrate	Calibrates the scale
SETUP	Setup	Accesses setup options for scale, features, serial output, print format, digital inputs and outputs, and displays the version number
TEST	Test	Performs a basic test on the A/D, digital inputs and outputs, communication ports, RAM, and keypad
DISPLAY	Display	Accesses the setup option for contrast, image, brightness
SETPTS	Setpoints	Used for setting up weigh mode setpoint accessible parameters using numeric values

Table 3-1. Menu Summary

3.2 Menu Navigation

Once menus have been entered, use the front panel buttons to navigate. Note the looped menu structure shown in Figure 3-1. This provides a shortcut for accessing the right-most menu items by navigating to the left, and vice versa for the opposite side of the menu. This shortcut also holds true for sub-menu navigation.

The front panel keys are also used to navigate through the menu structure:

-  and  move left and right (horizontally) in a menu level
-  and  move up and down to different menu levels
-  enters a menu or parameter and selects/saves parameter settings or values
-  to access user mode, to leave a parameter without making changes, or to return to weigh mode
- Use the numeric keypad to enter a value and press  to accept the value

 **NOTE:** To exit Configuration and return to weighing, press  or press the SAVEEXIT softkey.

3.3 Revolution Configuration

The Revolution configuration utility provides the preferred method for configuring the Counterpart indicator. Revolution runs on a personal computer to set configuration parameters for the indicator. When Revolution configuration is complete, configuration data is downloaded to the indicator.

Revolution supports both uploading and downloading of indicator configuration data. This capability allows configuration data to be retrieved from one indicator, edited, and then downloaded to another indicator with an identical hardware configuration.

To use Revolution, use the following steps:

1. Install Revolution on a personal computer.
2. With both indicator and PC powered off, connect the PC serial port to the RS-232 pins on the indicator serial port or to the optional USB communications card.
3. Power up the PC and the indicator. Use the setup switch to place the indicator in setup mode.
4. Start the Revolution program.

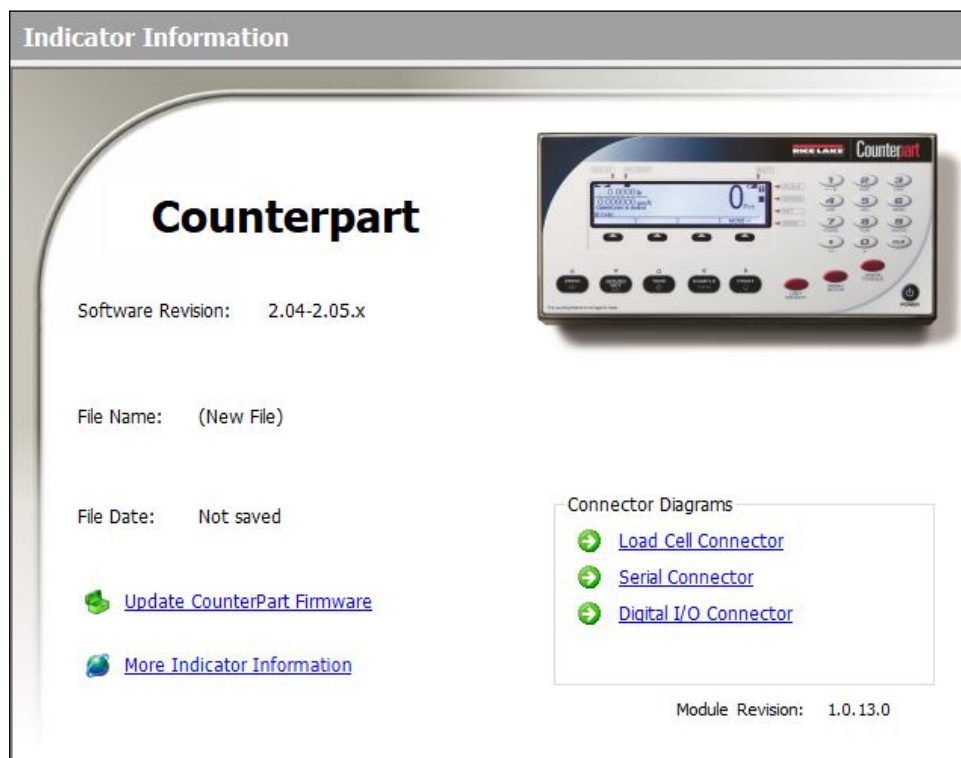

Figure 3-2. Revolution Display

Revolution provides on line help for each of its configuration displays. Parameter descriptions provided in this manual for front panel configuration can also be used when configuring the indicator using Revolution — the interface is different, but the parameters sets are the same.

3.4 ID Menu

The ID menu displays parameters for registers from 1 to 150. Sub-parameters are shown below.

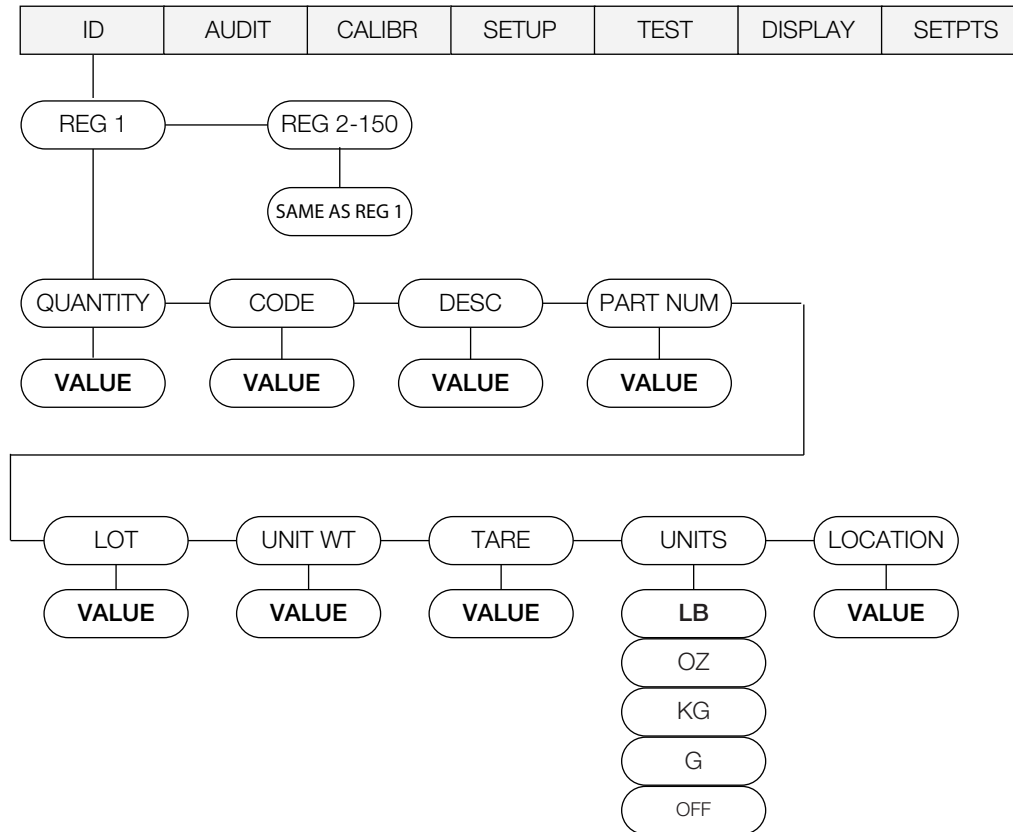



Figure 3-3. ID Menu Layout

ID Menu		
Parameter	Choices	Description
REG 1, 2 - 150	QUANTITY CODE DESC PART NUM LOT UNIT WT TARE UNITS LOCATION	Inventory quantity, range – -2,000,000,000 to 2,000,000,000 ID code for part, maximum 32 alphanumeric characters Part description, maximum 32 alphanumeric characters Part number, maximum 32 alphanumeric characters Part lot number, maximum 32 alphanumeric characters Unit weight, range 0.0 to 9999999.0 Tare weight, range 0.0 to 9999999.0 Weight units for both the unit weight value and the tare weight value, choices of: OFF, KG, G, LB, OZ Part stock location, maximum 11 alphanumeric characters

Table 3-2. ID Menu Parameters

3.5 Audit Menu

The audit menu accesses audit trail support. It provides tracking information for configuration and calibration events. To prevent potential misuse, all configuration and calibration changes are counted as change events. Audit information can be printed by pressing  while displaying the audit trail items beneath the AUDIT menu.

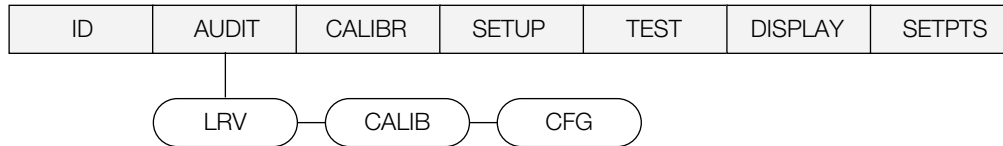



Figure 3-4. Audit Menu Layout

Parameter	Description
LRV	Legally relevant firmware version
CALIB	Displays total calibration events
CFG	Displays total configuration events

Table 3-3. Audit Menu Parameters

3.6 Calibration Menu

See [Section 4.0 on page 58](#) for calibration procedures. The Calibration menu can be protected by assigning a password in the Feature menu.

 **NOTE:** The Counterpart requires the WZERO and WSPAN points to be calibrated. The linearity points are optional, but must NOT duplicate zero or span. During calibration,  acts as a data entry confirmation key. It also acts as an EXECUTE key and accepts the value if calibration is successful.

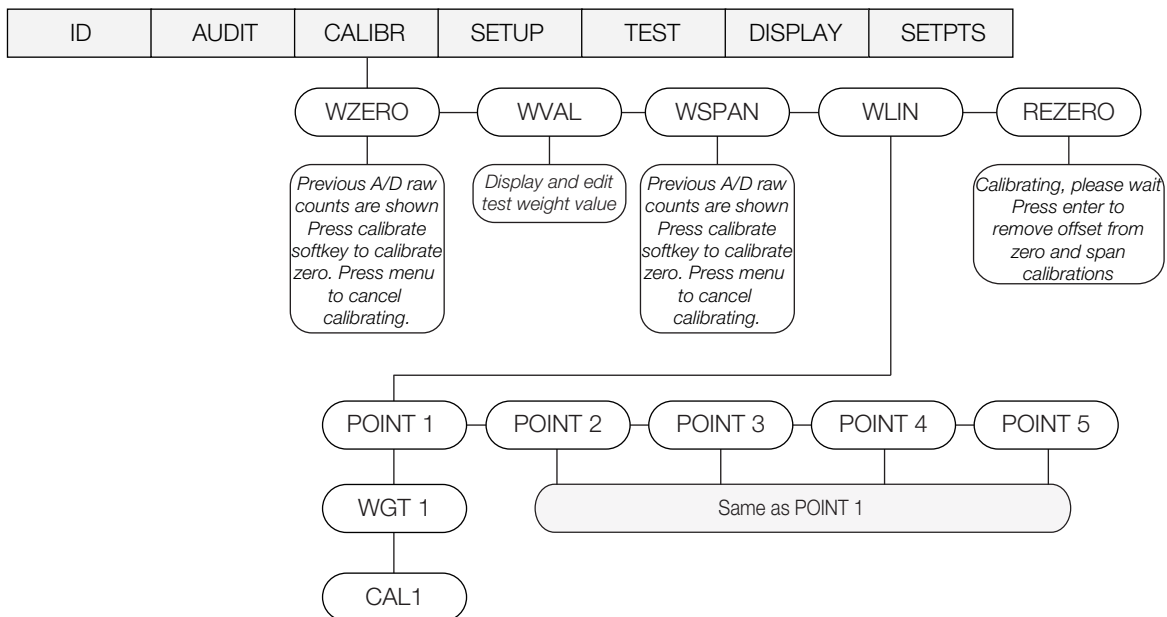

Figure 3-5. Calibration Menu Layout

CALIBR Menu		
Parameter	Choices	Description
Level 2 sub-menus		
WZERO	–	Press the calibrate softkey to display the AD raw counts; Press calibrate softkey again to calibrate zero, or press MENU to cancel; “CALIBRATING” appears prior to automatically moving to WVAL
WVAL	–	Press calibrate softkey to display and edit the test weight value; Press calibrate softkey again to move to WSPAN
WSPAN	–	Press the calibrate softkey to display the AD raw counts; Press the calibrate softkey to calibrate the span or press MENU to cancel; “CALIBRATING” appears prior to automatically moving to WLIN
WLIN	POINT 1 — POINT 5	WGT 1 allows for display and edit the test weight value; Press the calibrate softkey to edit the value; CAL1 allows for calibration and display of the raw AD value; Press TARE to perform calibration; Press the calibrate softkey to move to the next calibration point Note: The linearity points are optional, but must not duplicate zero or span. They must be between zero and span.
REZERO	–	Press the calibrate softkey to remove an offset value from the zero and span calibrations if hooks or chains are being used during calibration Note: Use this parameter only after WZERO and WSPAN have been set. See Section 4.1 on page 58 for more information.

Table 3-4. Calibration Menu Parameters

3.7 Setup Menu

The setup menu allows:

- Configuration of scale, features, serial port, Ethernet, print format, and digital inputs and outputs settings
- Viewing of the software and regulatory versions and reverting to default settings

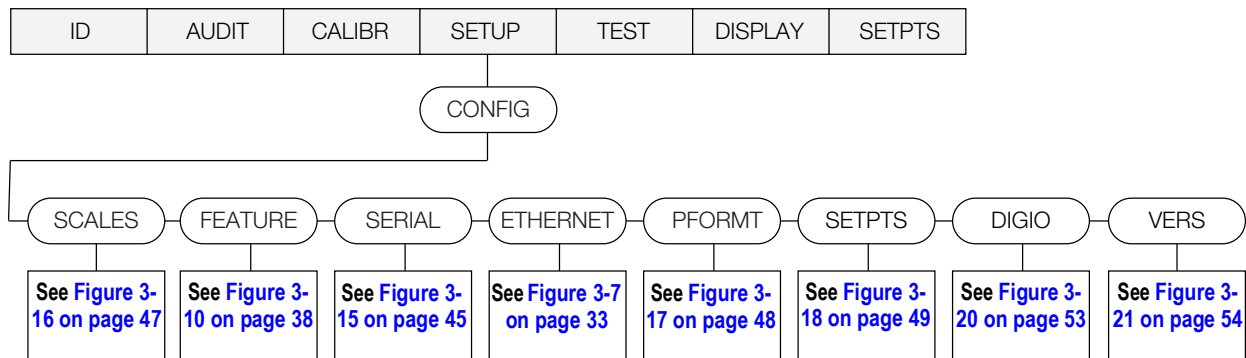

Figure 3-6. Setup Menu Layout

Menu	Choices	Menu Function
SCALES	Configuration	Configure and calibrate scales
FEATURE	Feature	Set passwords, keyboard locks, regulatory mode, and initial consecutive number value, count function, and define softkeys
SERIAL	PORT 1 PORT 2 PORT 3 (Option Card)	Configures the communications ports
ETHERNET	Ethernet	Configures the Ethernet port
PFORMT	Print Format	Set print format used for header, gross, net, count, pallet, setpoint and total ticket formats; See Section 6.0 on page 74 for more information
SETPTS	Setpoints	Configure setpoints
DIG IO	Digital IO	Assign digital input/output functions
VERS	Version	Display installed software version and regulatory version numbers; The Reset Config softkey on Version menu can be used to restore all configuration parameters to default values

Table 3-5. Setup Menu Parameters

3.7.1 Scale Menu

Calibration can be performed in two places within the menu: the CALIBR menu shown in [Figure 3-5 on page 31](#) is an in-depth scale setup and calibration. A “quick access” calibration is shown in [Figure 4-1 on page 58](#).

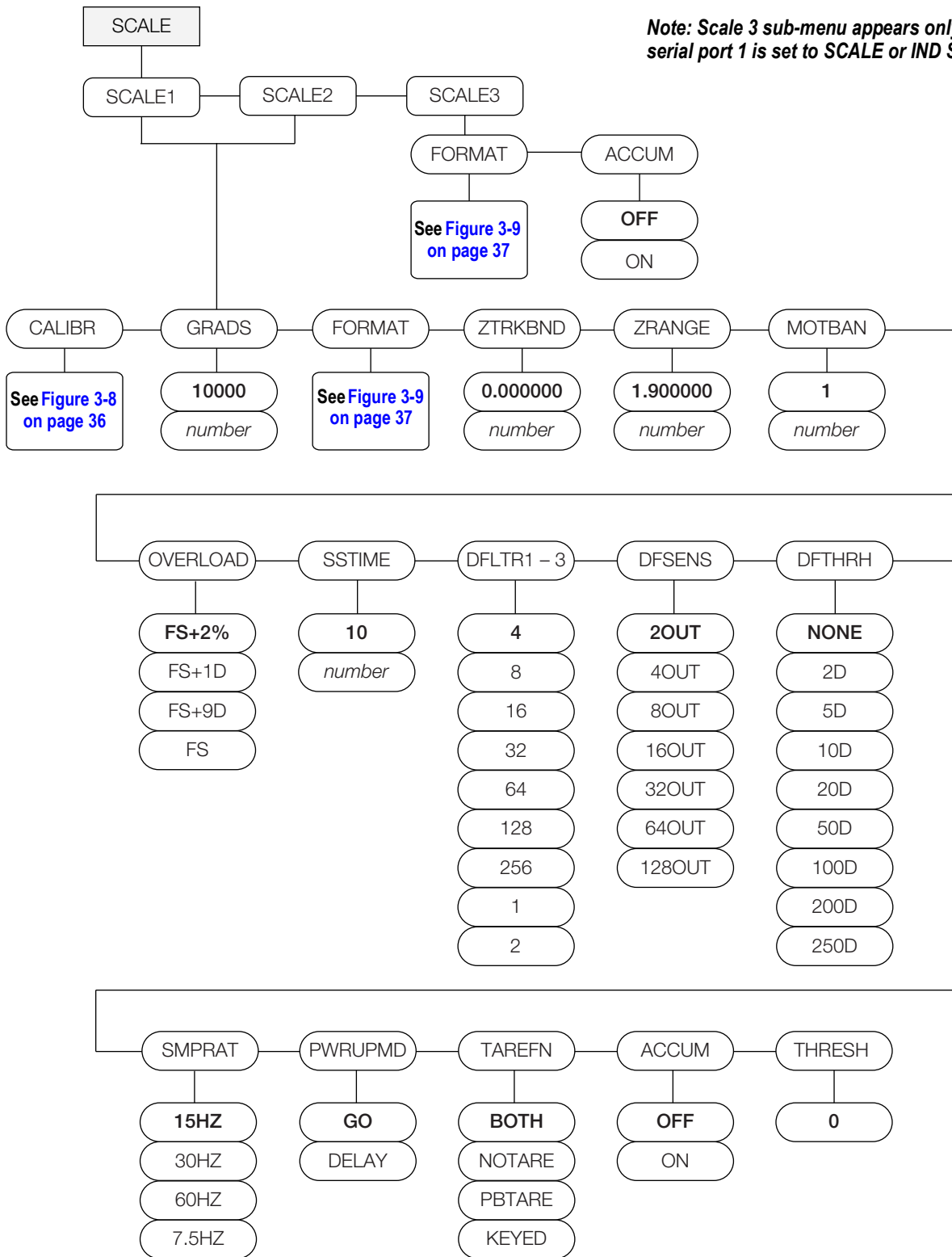

Figure 3-7. Setup – Scale Menu

Parameter	Settings	Description
Scales 1 and 2		Allows configuration and calibration of each scale
Scale 3		Allows configuration and calibration of scale 3
Scales sub-menu		
CALIBR	WZERO WVAL WSPAN WLIN REZERO	See Calibration Menu (Figure 3-8 on page 36)
GRADS	10000 1–1,000,000	Specifies the number of full scale graduations; The value entered must be in the range 1–100000 and should be consistent with legal requirements and environmental limits on system resolution; To calculate GRADS, use the formula: $GRADS = \text{Capacity} / \text{Display Divisions}$; Display divisions are specified under the FORMAT sub-menu
FORMAT	PRIMARY SEC TER	Select a primary, secondary, and tertiary unit of measure; Sub-choices include lb, kg, oz, and g; See Format menu (Figure 3-9 on page 37)
ACCUM	OFF ON	Enable/disable weigh accumulation; See Figure 5.9 on page 71 for information
ZTRKBND	0.000000 0.0–100.0	Automatically zeros the scale when within the range specified, as long as the input is within the ZRANGE and scale is at standstill; Specify the zero tracking band in \pm display divisions; Maximum legal value varies depending on local regulations Note: For scales using linear calibration, do not set the zero tracking band to a value greater than that specified for the first linearization point.
ZRANGE	1.900000 0.0–100.0	Selects the range within which the scale can be zeroed; The 1.900000 default value is $\pm 1.9\%$ around the calibrated zero point, for a total range of 3.8%. Indicator must be at standstill to zero the scale; Use the default value for legal-for-trade applications
MOTBAND	1 0–100	Sets the level, in display divisions, at which scale motion is detected; If motion is not detected for 1 second or more, the standstill symbol lights; Some operations, including print, tare, and zero, require the scale to be at standstill; Maximum legal value varies depending on local regulations; If this parameter is set to 0 the standstill annunciator does not light; Operations normally requiring standstill (zero, tare, print) are performed regardless of scale motion; If 0 is selected, ZTRKBND must also be set to 0
OVRLOAD	FS+2% FS+1D FS+9D FS	Overload; Determines the point at which the display blanks and an out-of-range error message displays; Maximum legal value varies depending on local regulations
SSTIME	10 1–65,535	Specifies the length of time the scale must be out of motion, in 0.1-second intervals, before the scale is considered to be at standstill; Values greater than 10 are not recommended;
DFLTR 1-3	4 8 16 32 64 128 256 1 2	Selects the digital filtering rate used to reduce the effects of mechanical vibration from the immediate area of the scale. The overall filtering effect can be expressed by adding the values assigned to the three filter stages: $DFLTR1 + DFLTR2 + DFLTR3$ See Section 9.6 on page 96 for information on digital filtering; Choices indicate the number of AD conversions per update that are averaged to obtain the displayed reading; A higher number gives a more accurate display by minimizing the effect of a few noisy readings, but slows down the settling rate of the indicator
DFSENS	4OUT 20OUT 8OUT 16OUT 32OUT 64OUT 128OUT	Digital filter cutout sensitivity; Specifies the number of consecutive readings that must fall outside the filter threshold (DFTHR parameter) before digital filtering is suspended

Table 3-6. Scales Menu Parameters

Parameter	Settings	Description
DFTHRH	NONE 2D 5D 10D 20D 50D 100D 200D 250D	Digital filter cutout threshold. Specifies the filter threshold, in display divisions; When a specified number of consecutive scale readings (DFSSENS parameter) fall outside of this threshold, digital filtering is suspended; If NONE is selected, the filter is always enabled
SMPRAT	15 HZ 30 Hz 60 Hz 7.5 Hz	Sample rate; Selects measurement rate, in samples per second, of the analog-to-digital converter; Lower sample rate values provide greater signal noise immunity
PWRUPM	GO DELAY	Power up mode; In GO mode, the indicator goes into operation immediately after a brief power up display test; In DELAY mode, the indicator performs a power up display test and then enters a 30-second warm-up period; If no motion is detected during the warm-up period, the indicator becomes operational when the warm-up period ends; If motion is detected, the delay timer is reset and the warm-up period is repeated
TAREFN	BOTH NOTARE PBTARE KEYED	Enables or disables push-button and keyed tares; Possible values are: BOTH: Both push-button and keyed tares are enabled NOTARE: No tare allowed (gross mode only) PBTARE: Push-button tares enabled KEYED: Keyed tare enabled
ACCUM	OFF ON	Accumulator; Specifies whether the scale accumulator is enabled; If enabled, accumulation occurs whenever a print operation is performed; Scale must return to zero to re-arm a new print
THRESH	0 0-9,999,999	Enter a value to be used as divisions; Select Zero threshold to display a threshold or reset point where automatic printing functions reset themselves to be retriggered; When a value is entered, anything that would normally require the scale to reach zero before it happens/rearms (except for LFT parameters) now only needs to go below this value and then above it again

Table 3-6. Scales Menu Parameters (Continued)

Scale Calibration Menu

Calibration can be performed in two places within the menu: the CALIBR menu shown in Figure 3-5 on page 31 is an in-depth scale setup and calibration.

A “quick access” calibration is shown in Figure 4-1 on page 58.

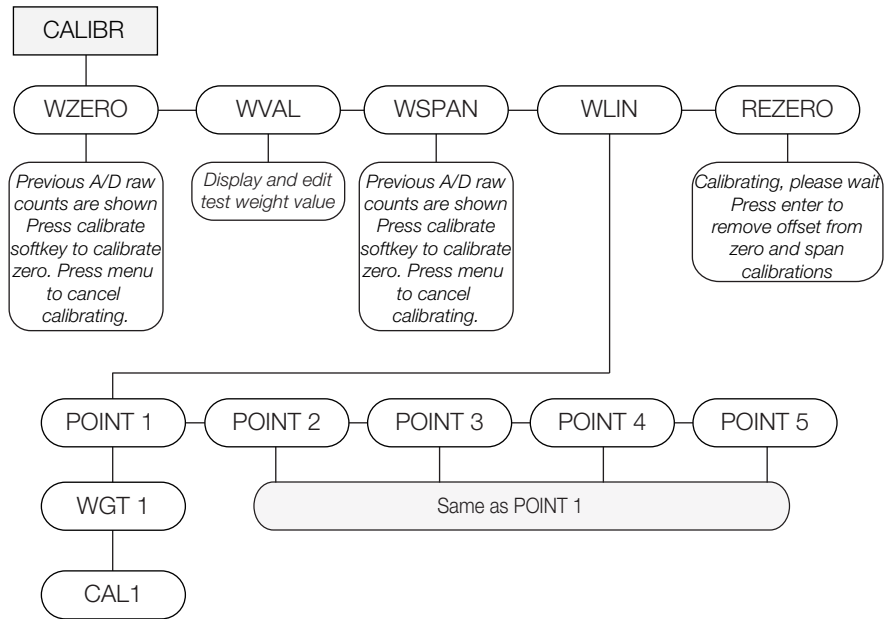

Figure 3-8. Scale Calibration Menu Layout

Parameter	Settings	Description
WZERO	–	View or change the zero calibration AD count value
WVAL	–	View and edit the test weight value
WSPAN	–	View or change the span calibration AD count value
WLIN	POINT 1-5	Press ENTER to display and edit test weight and calibration values for up to five linearization points; Perform linear calibration only after WZERO and WSPAN have been set; Parameters include CAL1 – View or change linear point calibration value WGT1 – Sets test value
REZERO	–	Removes offset from zero and span calibrations; Can be used during a span calibration process using hooks and chains

Table 3-7. Scale Calibration Menu Parameters

Scale Format Menu

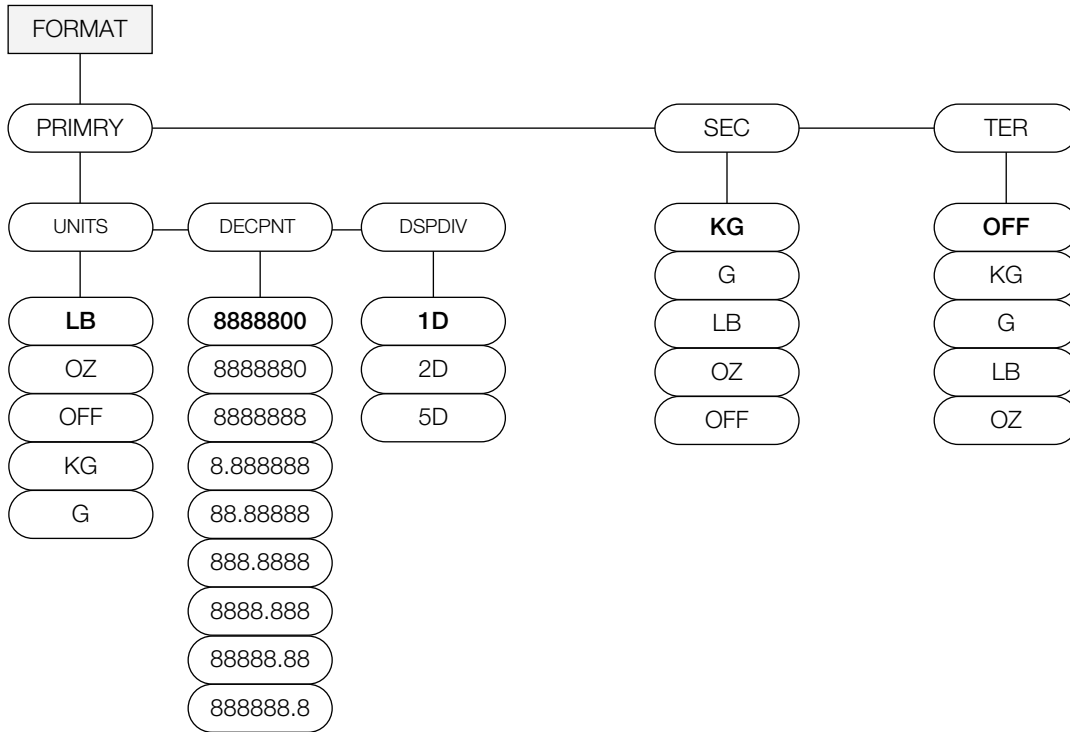

Figure 3-9. Scale Format Menu Layout

Parameter	Settings	Description
PRIMARY	UNITS DECPNT DSPDIV	Set the primary units, decimal point format, and display divisions
SEC	KG G LB OZ OFF	Set the secondary units; Decimal point format and display divisions are selected automatically; Values are kg = kilogram (default); g = gram; lb = pound; oz = ounce; and off Note: If using the <cu> token and secondary or tertiary values are changed, the stream tokens must be changed to match in order to stream secondary or tertiary.
TER	OFF KG G LB OZ	Set the tertiary units; Decimal point format and display divisions are selected automatically; Values are off (default); kg = kilogram; g = gram; lb = pound; oz = ounce Note: If using the <cu> token and secondary or tertiary values are changed, the stream tokens must be changed to match in order to stream secondary or tertiary.
Primary, Secondary, Tertiary sub-menu		
UNITS	LB OZ KG G OFF	Specifies primary units for displayed and printed weight; Values are lb = pound; oz = ounce; kg = kilogram; g = gram
DECPNT	8888800 8888880 8888888 8.888888 88.88888 888.8888 8888.888 88888.88 888888.8	Place the decimal point position; Use the ID and TARGET keys to place the decimal point where desired
DSPDIV	1D 2D 5D	Display divisions; Selects the minimum division size for the primary unit's displayed weight

Table 3-8. Scale Format Menu Parameters

3.7.2 Feature Menu

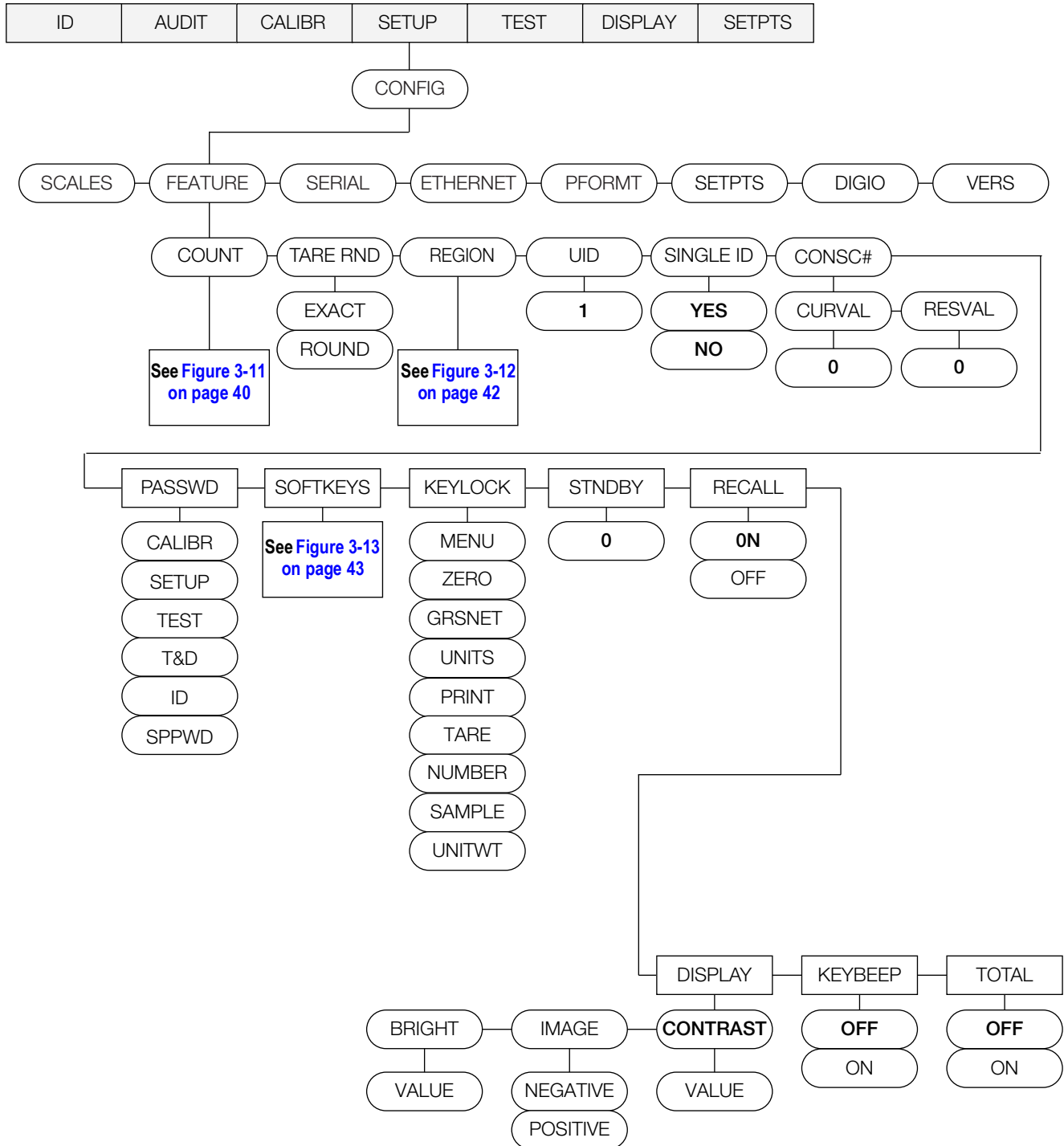

Figure 3-10. FEATUR Sub-menu

Parameter	Settings	Description
COUNT	NEGCOUNT SAMPLEQTY INSFSMPL LOTUPDT SCLCHG NEWITEM XFRSMPL DISPACC UTWTUPDT UTWTBASE DSPMODE REMOVTSP	Configuration for the counting features (Figure 3-11 on page 40)
TARE RND	ROUND EXACT	When transferring tare to the second scale, tare value remains the exact weight or rounds to scale resolution
REGION	REGULA REGWRD DECfmt TIME DATE	Selects regional settings (Figure 3-12 on page 42)
UID	1	Sets the unit ID, a string of up to 6 ASCII characters; This will be used in place of the <UID> token in a print format
SINGLE ID	Yes No	Allows entry of a temporary ID
CONSC#	CURVAL RESVAL	Allows sequential numbering for print operations; <ul style="list-style-type: none"> • CURVAL is the current/starting value • RESVAL is the ending/reset value The consecutive number value is incremented following each print operation that includes <CN> in the ticket format; When the consecutive number is reset, it is reset to the RESVAL specified on the parameter
PASSWD	CALIBR SETUP TEST T&D ID	Creates a password to access the CALIBR, SETUP, TEST, T&D, and ID menus; Specify a non-zero value to restrict access to all configuration menus; Passwords can be overridden by loading new firmware or entering 999999; <p>Note: Overriding passwords will clear configuration and calibration settings. To preserve settings (such as ID information), use Revolution software to upload data to a PC, and then download it back to the indicator after the password override is performed.</p>
SOFTKEYS	SK1-12	See Figure 3-13 on page 43
KEYLCK	MENU ZERO GRSNET UNITS PRINT TARE NUMBER SAMPLE UNIT WT	Disables the MENU, ZERO, GROSS/NET, UNITS, PRINT, TARE, NUMBER, SAMPLE and UNIT WEIGHT keys; Select LOCK to disable the key, and UNLOCK to enable the key; The default for all is UNLOCK
STNDBY	0 0-255	Standby mode delay; Specifies the number of minutes the indicator must be inactive before entering standby mode; When in standby mode, power is still supplied to the CPU and draws half of the current as when the display is powered; The display is no longer updated and the backlight is off; Press any key to exit standby mode and reactivate the display; The indicator enters standby mode if no key presses, serial communications, or scale motion occur for the length of time specified in this parameter. Set to 0 to disable standby mode <p>Note: If regulatory agency is set for NONE or INDUST, the standby will occur after the specified number of minutes regardless of how much weight is on any of the scales. If regulatory agency is set for NTEP, OIML, or Canada a standby will only occur when the weight on the currently viewed scale is at center of zero.</p>
RECALL	ON OFF	ON allows the Tare, Zero, and Units values to be maintained across a power cycle; Over/Under/Target/ID values are also maintained; OFF clears the values on a power cycle; Zero is reset to calibrated zero and Units are reset to Primary; Over/Under/Target/ID values are reset as well
DISPLAY	CONTRAST BRIGHT IMAGE	Adjusts Counterpart display viewing; Key in a value: BRIGHT – Key in a value IMAGE – Enter negative or positive
KEYBEEP	OFF ON	Select ON to alert the user every time a key is pressed
TOTAL	OFF ON	Totalization motion check; When attempting a totalization, a motion check can be performed; ON - Performs a motion check; If there is motion, then one more attempt will be made after two seconds; If totalization is unsuccessful, MOTION displays; OFF - No motion check is performed

Table 3-9. Feature Menu Parameters

Feature Count Menu

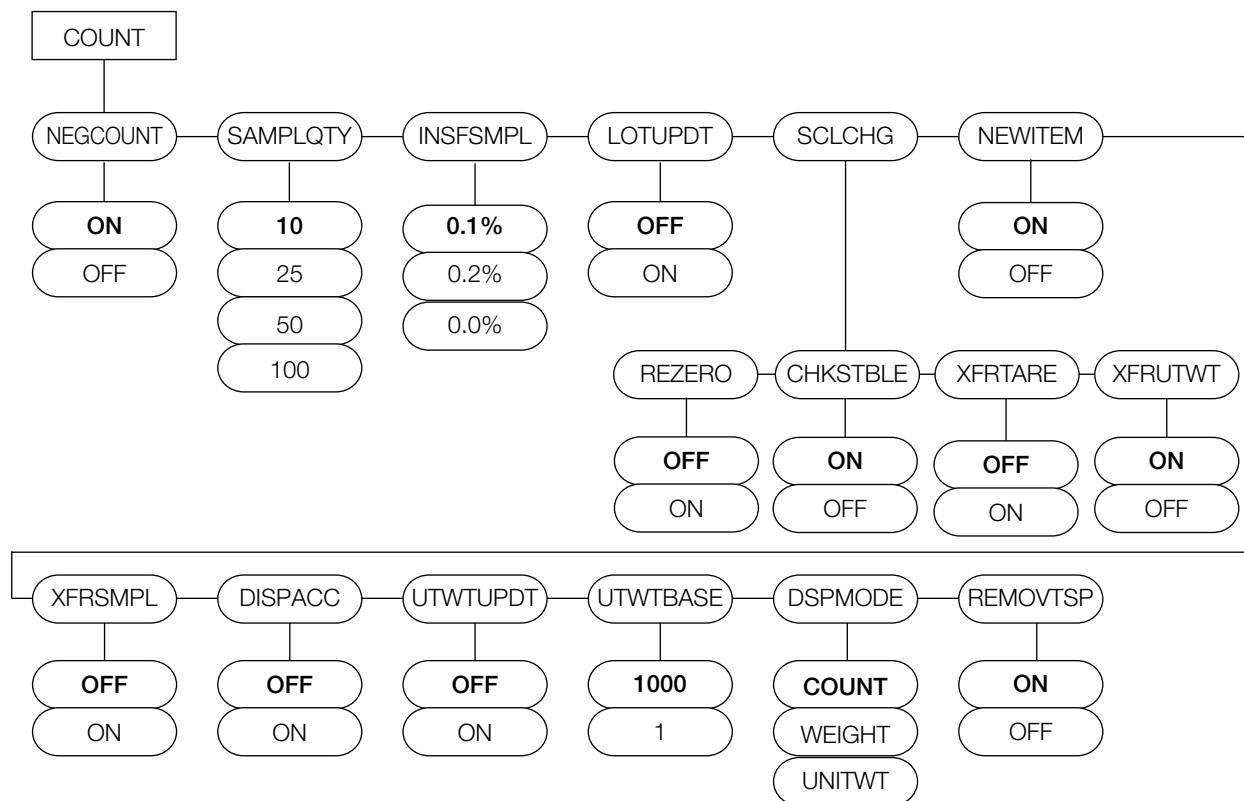

Figure 3-11. Count Menu Layout

Parameter	Settings	Description
NEGCOUNT	ON OFF	Sets whether negative counting mode is off or on
SAMPLQTY	10 25 50 100	Is the default value for sample quantity
INSFSMPL	0.1% 0.2% 0.0%	Insufficient sample; Specifies the minimum sample weight as a percentage of the scale capacity; The 0.0% selection disables the insufficient sample weight check
LOTUPDT	OFF ON	Lot update; Enables or disables the updating of the stored ID with a new lot value; A new lot value can be keyed or scanned; The new lot value always overwrites the lot value of the working ID; OFF – The new lot value is not saved into the stored copy of the currently loaded ID record; ON – The new lot value is saved into the stored copy of the currently loaded ID record; If WeighVault is in use, an update will also be made to the ID in WeighVault; This parameter has no effect if an ID is not loaded from a stored ID
SCLCHG	REZERO CHKSTABLE XFRRTARE XFRUTWT	Scale change; These are actions taken when changing from one scale to another; See SCLCHG sub-menu below
NEWITEM	OFF ON	New item; This prompts the user to add an ID to memory when an unknown ID is requested from weigh mode; Weighmode parameter is ignored if the WeighVault is being used; When using WeighVault a new ID cannot be created from weigh mode
XFRSMPL	OFF ON	After sample; After a sample, a switch is done from the current scale to the next scale that is larger than or equal to the current scale; If a sample is done on the largest of the scales, a switch will not be done
DISPACC	OFF ON	Display accuracy; Enable or disable the display of the computed accuracy percentage from a sample operation

Table 3-10. Count Menu Parameters

Parameter	Settings	Description
UTWTUPDT	OFF ON	Unit weight update; Enables or disables the updating of the stored ID with a new unit weight value; Parts can be sampled (generating a new unit weight) or a unit weight can be keyed or scanned; The new unit weight always overwrites the unit weight of the working ID; OFF – The new unit weight is not saved into the stored copy of the currently loaded ID record; ON – The new unit weight is saved into the stored copy of the currently loaded ID record; If WeighVault is in use, an update will also be made to the ID in WeighVault; This parameter has no effect if an ID is not loaded from a stored ID
UTWTBASE	1000 1	Unit weight base; 1 = APW (Average Piece Weight), 1000 = Piece weight per thousand
DISPMODE	COUNT WEIGHT UNITWEIGHT	Display mode; This chooses the value which displays as large in viewing window
REMOVTSP	ON OFF	Removes trailing spaces from ID Codes; <ul style="list-style-type: none"> • ON — If set to ON: <ul style="list-style-type: none"> - An ID code configured through the ID menu will have any entered trailing spaces removed before being stored; - An ID code configured through the ID.CODE EDP command will have any entered trailing spaces removed prior to being stored; - Trailing spaces will be removed from an ID Code that is entered via the Code softkey; This includes using the front panel or USB keyboard; - Trailing spaces will be removed from an ID Code that is scanned from a barcode; • OFF — If set to OFF: <ul style="list-style-type: none"> - An ID code configured through the ID menu will be stored with trailing spaces as entered; - An ID code configured through the ID.CODE.EDP command will be stored with trailing spaces as entered; - An ID code entered via the Code softkey for recall will retain any trailing spaces; This includes using the front panel or USB keyboard; - An ID Code scanned from a barcode for recall will retain any trailing spaces
SCLCHG submenu		
REZERO	OFF ON	Performs a zero function on scale change
CHKSTBLE	ON OFF	When changing scales, a stability check can be either enabled or disabled; If enabled, and the stability check is successful, no indication is shown and the unit switches to the next scale; If enabled and the stability check fails, then NON-STABLE is shown on the display and the switch to the next scale is not made
XFRTARE	OFF ON	When changing scales, the tare weight is transferred from the current scale to the new scale; Units must be set to the same unit of measurement
XFRUTWT	ON OFF	When changing scales, the unit weight is transferred from the current scale to the new scale

Table 3-10. Count Menu Parameters (Continued)

Feature Region Menu

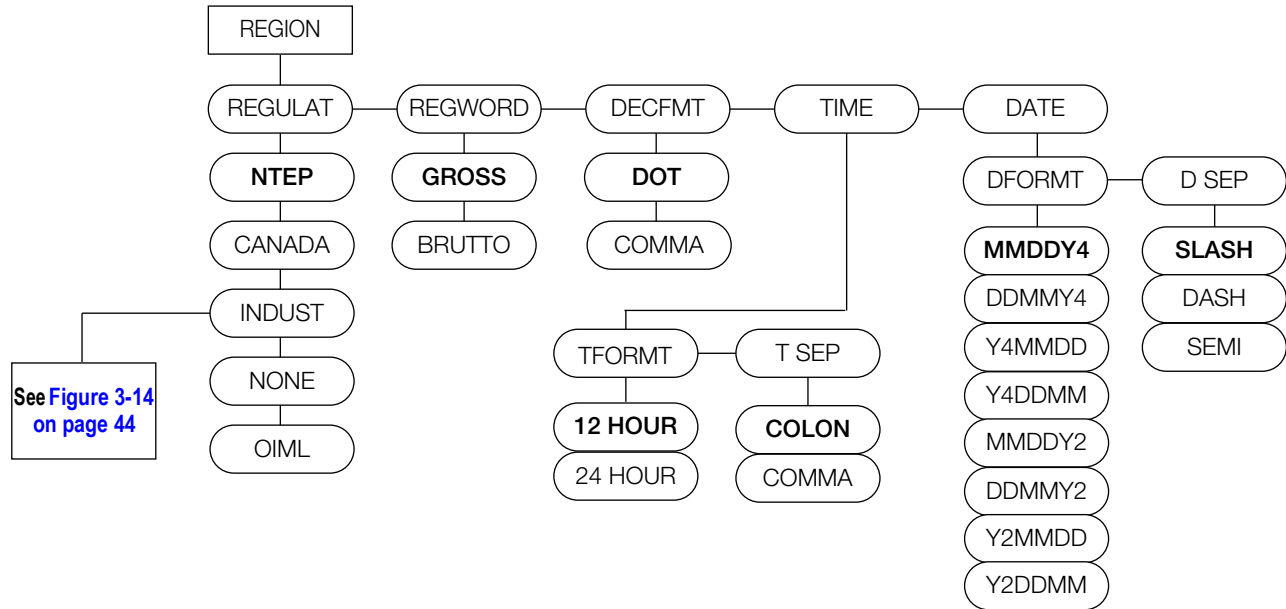

Figure 3-12. Region Menu Layout

Parameter	Settings	Description
REGULA	NTEP CANADA INDUST NONE OIML	Regulatory mode. Specifies the regulatory agency having jurisdiction over the scale site; Note: The value specified for REGULA affects the function of the front panel TARE and ZERO keys. <ul style="list-style-type: none"> OIML, NTEP, and CANADA modes allow a tare to be acquired at any weight greater than zero; NONE allows tares to be acquired at any weight value OIML, NTEP, and CANADA modes allow a tare to be cleared only if the gross weight is at no load; NONE allows tares to be cleared at any weight value NTEP and OIML modes allow a new tare to be acquired even if a tare is already present; In CANADA mode, the previous tare must be cleared before a new tare can be acquired NONE, NTEP and CANADA modes allow the scale to be zeroed in either gross or net mode as long as the current weight is within the specified ZRANGE; In OIML mode, the scale must be in gross mode before it can be zeroed; pressing the ZERO key in net mode clears the tare INDUST provides a set of subparameters to allow customization of tare, clear, and print functions in non-legal-for-trade scale installations When in legal-for-trade mode, refer to Section 9.10 on page 100 for more information on using this feature
REGWOR	GROSS BRUTTO	Sets the term printed when weighing in gross mode; Selecting BRUTTO replaces <i>Gross</i> with <i>Brutto</i>
DECfmt	DOT COMMA	Specifies whether decimal numbers display using a period (DOT) or a comma
TIME	TFORMT T SEP	Sets the current time, and the time format and separator character; See Time sub-menu below
DATE	DFORMT D SEP	Sets the current date, and date format and date separator character
Time sub-menu		
TFORMT	12 HOUR 24 HOUR	Sets the time format
T SEP	COLON COMMA	Sets the time separator as a colon or a comma
Date sub-menu		
DFORMT	MMDDY4 DDMMY4 Y4MMDD Y4DDMM MMDDY2 DDMMY2 Y2MMDD Y2DDMM	Sets the date format; Y4 will use a four-digit year value, such as 2011, while Y2 will use a two-digit value, such as 11
D SEP	SLASH DASH SEMI	Sets the date separator as a slash, dash, or semicolon

Table 3-11. Region Menu Parameters

SOFTKEYS Menu

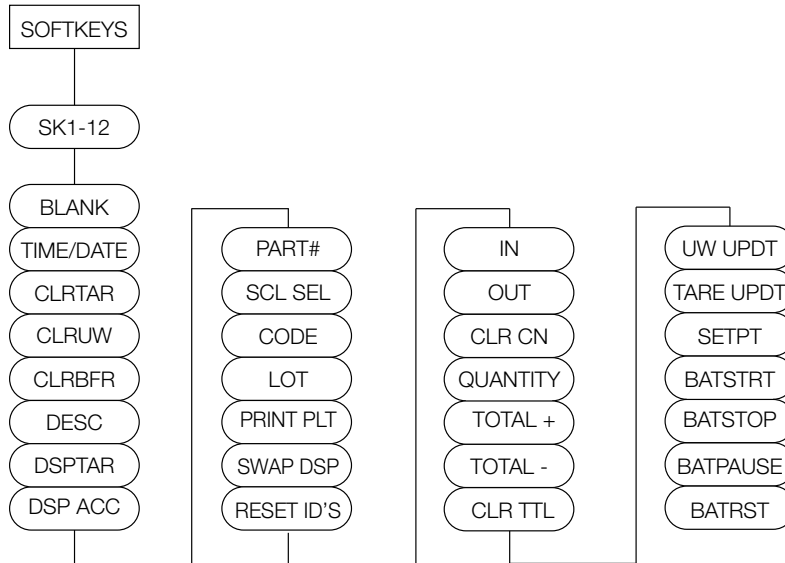

Figure 3-13. Softkey Menu Layout

Parameters	Descriptions
BLANK	No softkey function selected
TIMEDATE	Allows user view/set time and date
CLRTAR	Clear tare
CLRUW	Clear unit weight value
CLRBFR	Clears the WeighVault transaction communication buffer; Any buffered transactions will be lost; This is generally used when troubleshooting a WeighVault communication issue
DESC	Description update
DSPTAR	Display tare value (times out after 10 seconds)
DSPACC	Display accumulated weight value (may print or clear while displayed) – times out after 10 seconds
PART #	Part number entry
SCLSEL	Allows user to select scale 1, scale 2 for displayed weight count in multi-scale unit
CODE	Press CODE, enter ID number, press ENTER to recall stored item code; If item code does not exist, will prompt "Item not found, Save as New ID?"; Pressing YES will store in first available register; Alpha ON/OFF softkey appears to turn off Alpha to process numbers quicker when not using Alpha
LOT	Allows user to add lot number to stored item code on the fly (if enabled to do so)
PRINTPLT	Allows user to print a pallet label
SWAPDSP	Allows user to swap large display between weight, count, unit weight
RESET ID'S	Reset or clear ID's/codes
IN	Used to add, subtract count from inventory value (local or WeighVault)
OUT	
CLRCN	Sets consecutive number back to RESVAL (beginning reset value)
QUANTITY	Update quantity for IN/OUT inventory database
TOTAL+	Used with totalization mode or parts reduction count mode to add or subtract items from total accumulated count; CLRRTTL will clear the totalized value
TOTAL-	
CLRRTTL	
UWUPDT	Update stored unit weight or tare weight for currently loaded item code
TAREUPDT	
SETPT	Change setpoint value
BATSTRT	Batch start
BATSTOP	Batch stop
BATPAUSE	Pause batch
BATRST	Reset batch

Table 3-12. Softkey Menu Parameters

Regulate Industry Menu

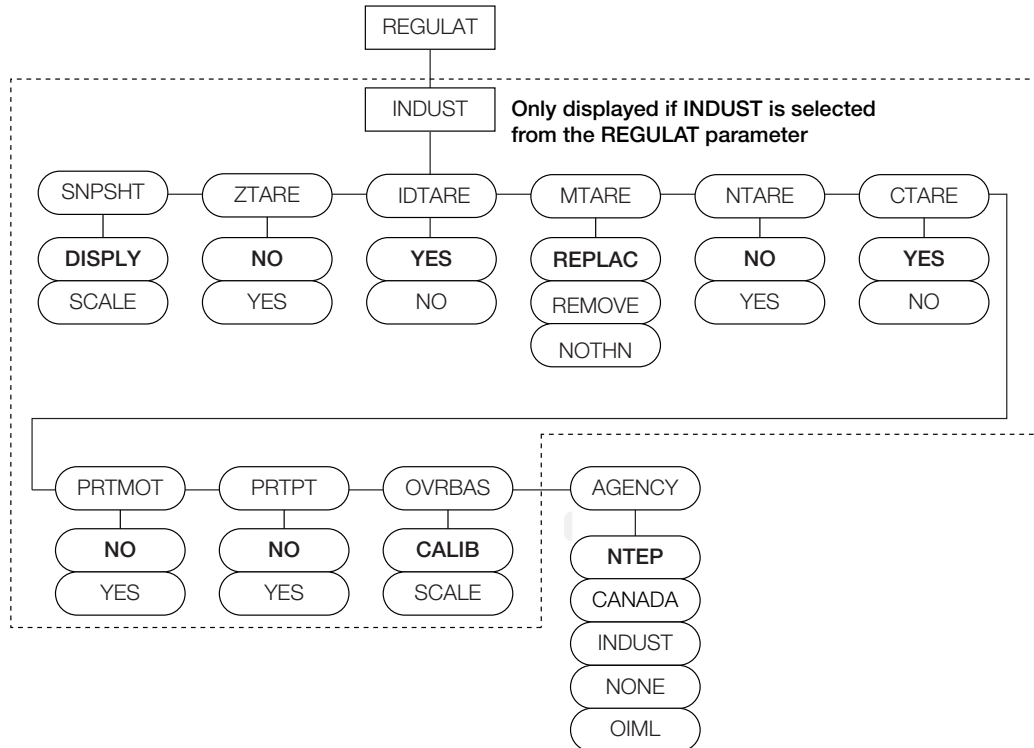
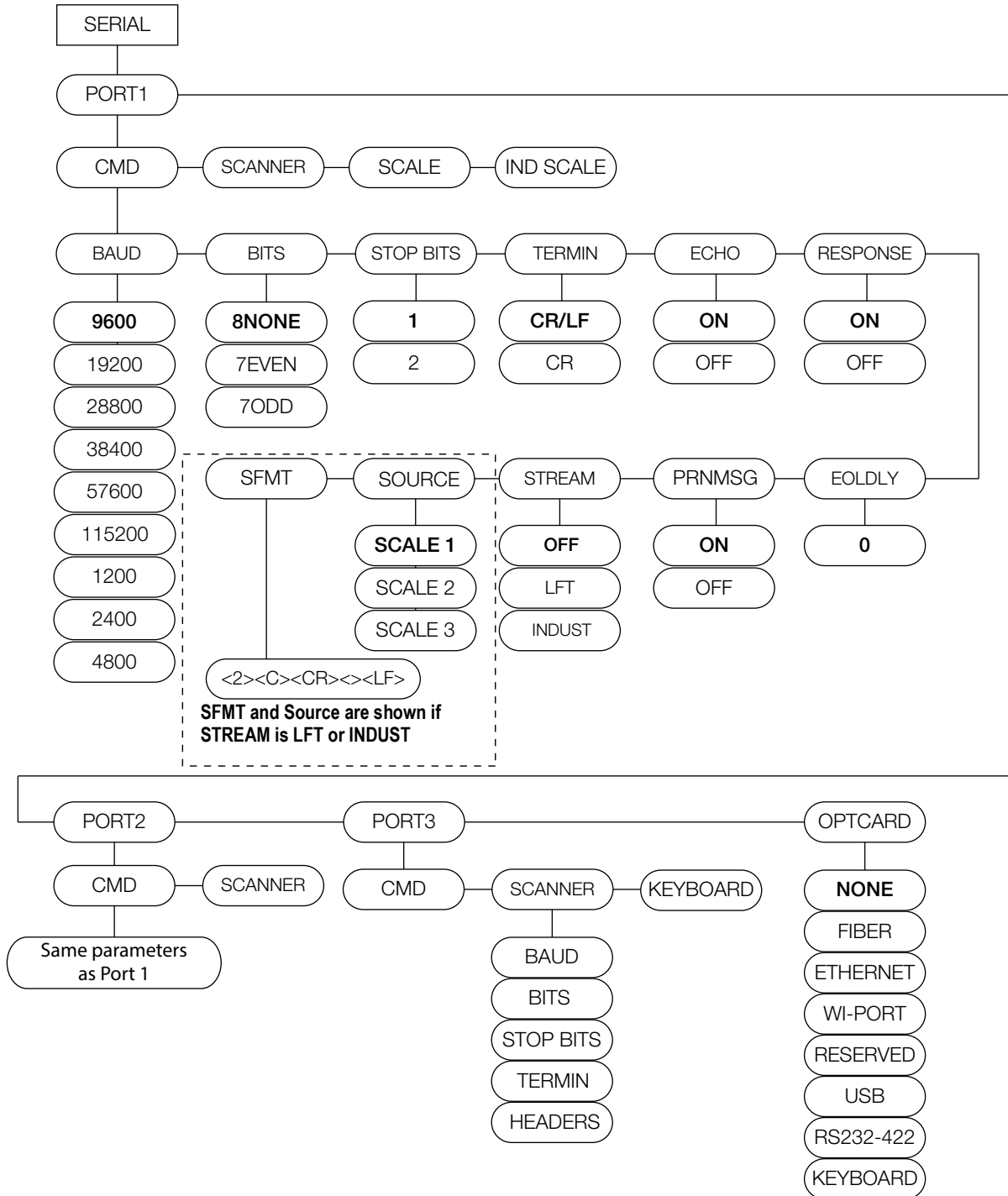

Figure 3-14. Regulatory Industrial Menu Layout

Parameter	Settings	Description
SNPSHT	DISPLY SCALE	Display or scale weight source
ZTARE	NO YES	Remove tare on ZERO
IDTARE	YES NO	Always allow keyed tare
MTARE	REPLAC REMOVE NOTHN	Multiple tare action
NTARE	NO YES	Allow negative or zero tare
CTARE	YES NO	Allow CLEAR key to clear tare/accumulator
PRTMOT	NO YES	Allow print while in motion
PRTPT	NO YES	Add PT to keyed tare print
OVRBAS	CALIB SCALE	Zero base for overload calculation CALIB = Calibrated Zero SCALE = Scale Zero
AGENCY	NTEP CANADA INDUST NONE OIML	<p>Selects the agency having jurisdiction over the scale site;</p> <ul style="list-style-type: none"> OIML, NTEP, and CANADA modes allow a tare to be acquired at any weight greater than zero; NONE allows tares to be acquired at any weight value; A tare can be cleared only if the gross weight is at no load; NONE allows tares to be cleared at any weight value; NTEP and OIML modes allow a new tare to be acquired even if a tare is already present; In OIML mode, printing is not allowed if the scale is more than -20dd; In CANADA mode, the previous tare must be cleared before a new tare can be acquired; NONE, NTEP and CANADA modes allow the scale to be zeroed in either gross or net mode as long as the current weight is within the specified ZRANGE; In OIML mode, the scale must be in gross mode before it can be zeroed; Pressing ZERO in net mode clears the tare; INDUST provides a set of subparameters to allow customization of tare, clear, and print functions in non-legal-for-trade applications; <p>The value specified for this parameter affects the function of the front panel TARE and ZERO keys; See Section 9.9 on page 99 for more information; When in legal-for-trade mode, refer to Section 9.10 on page 100 for more information</p>

Table 3-13. Regulate Industry Menu Parameters

3.7.3 Serial Menu



SFMT SOURCE STREAM PRNMSG EOLDLY

SCALE 1 LFT INDUST

SCALE 2

SCALE 3

<2><C><CR><<><LF>

SFMT and Source are shown if STREAM is LFT or INDUST

Figure 3-15. Serial Menu Layout

Parameter	Settings	Description
PORT 1 PORT 2 PORT 3	CMD SCANNER SCALE IND SCALE KEYBOARD	Specifies Port 1 through 3's mechanism for triggering a transmission of data, print message, baud rate, bits, stop bits, termination character, end-of-line delay, and echo; See Ports sub-menus for parameter descriptions
OPTCARD	NONE FIBER ETHERNET WI-POR RESERVED USB RS232-422 KEYBOARD	Option card parameters; Indicates which connection can be selected when using a wireless option card and WeighVault NOTE: When setting up the USB option and opening Revolution, a prompt may display to load a driver if Windows PC has not previously used a USB driver.
Ports sub-menus		
CMD	BAUD BITS STOP BITS TERMIN ECHO RESPONSE EOLDLY STREAM **SOURCE **SFMT	Configures the port for EDP command processing NOTE: For SOURCE and SFMT to appear on menu, first configure the STREAM parameter for either LFT (legal-for-trade) or INDUST (Industrial).
SCANNER	BAUD BITS STOP BITS TERMIN HEADERS	Configures the port as a barcode scanner input
SCALE	BAUD BITS STOP BITS TERMIN EOLDLY SFMT	Configures the port as a serial scale input
IND SCALE	BAUD BITS STOP BITS TERMIN EOLDLY SFMT	Configures the port as an industrial serial scale input
KEYBOARD	-	Enables the USB keyboard option

Table 3-14. Serial Menu Parameters

3.7.4 Ethernet Menu

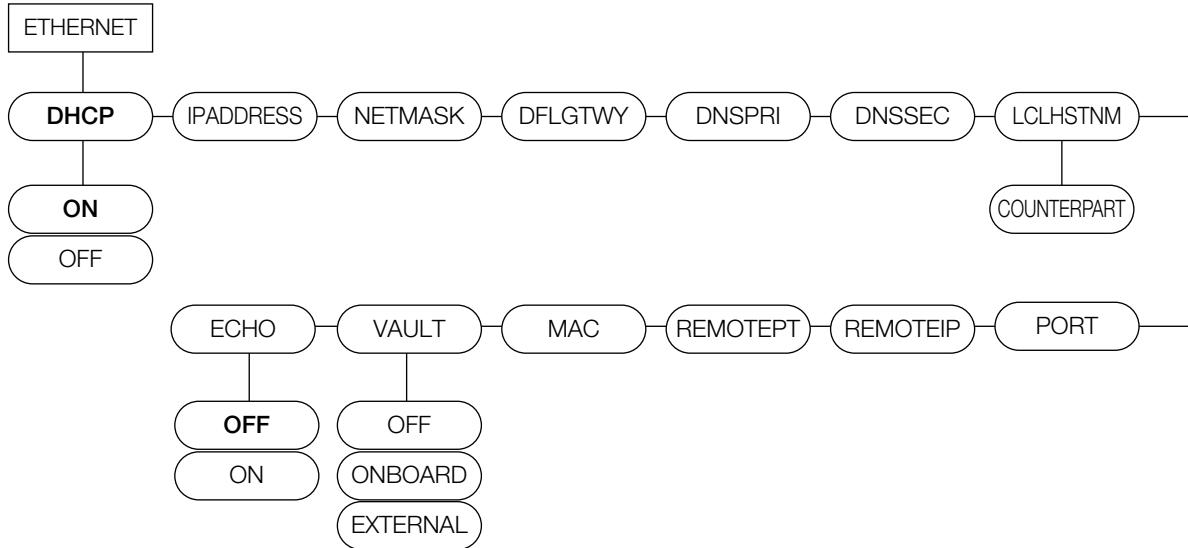

Figure 3-16. Ethernet Menu Layout

Parameter	Settings	Description
DHCP	ON OFF	Dynamic Host Configuration Protocol ON – Obtains IP address, primary and secondary DNS IP addresses, netmask, and default gateway IP address from a DHCP server; OFF – Uses static settings for the above parameters
IPADDRESS	–	IP address; This can be leased (provided by DHCP server) or statically set
NETMASK	–	Subnet address
DFFLTGTWY	–	IP address for default gateway
DNSPRI	–	Primary domain server IP address
DNSSEC	–	Secondary domain server IP address
LCLHSTNM	Counterpart	Counterpart local host name
PORT	–	Port number used
REMOTEIP	–	Remote IP address using WeighVault
REMOTEPT	–	Remote port number using WeighVault
MAC	–	Views the MAC address and is non-changeable
VAULT	OFF ONBOARD EXTERNAL	Disables WeighVault communication; Enables WeighVault using the onboard RJ45 Ethernet connection; Enables WeighVault using the optional wireless port connection
ECHO	ON OFF	Enable or disable the echoing of received characters

Table 3-15. Ethernet Menu Parameters

3.7.5 Print Format Menu

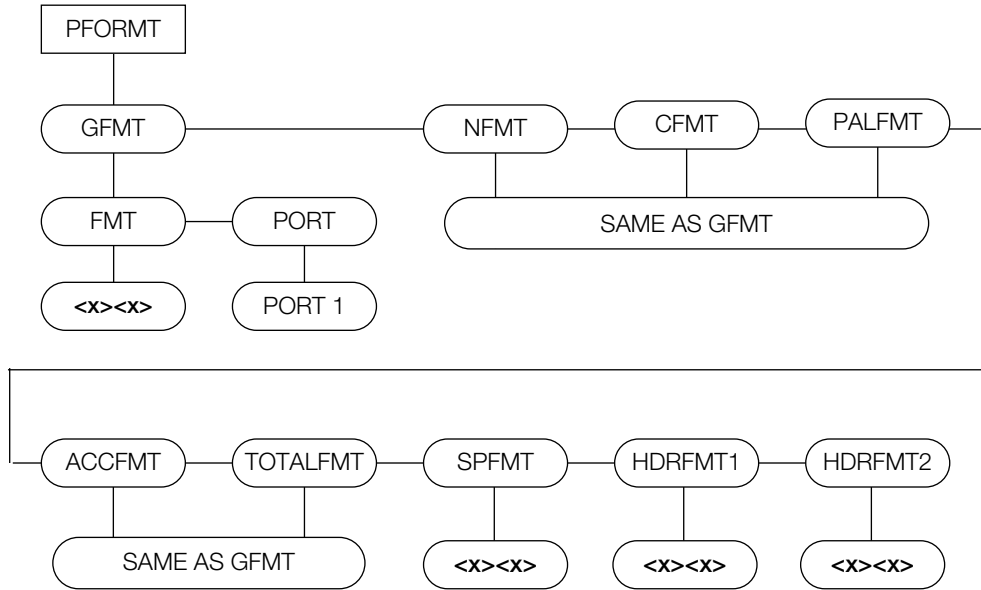

Figure 3-17. Print Format Menu

Parameter	Settings	Description
PFORMT	GFMT	Sets the print format for gross weight mode, net weight mode, count, pallet, accumulate, total, setpoint, header 1 and header 2 Gross format
	NFMT	Net format
	CFMT	Count format
	PALFMT	Pallet format
	ACCFMT	Accumulator format
	TOTALFMT	Total format
	HDRFMT1	Header 1 format
	HDRFMT2	Header 2 format

Table 3-16. Print Format Menu Parameters

3.7.6 Scale Setpoints Menu

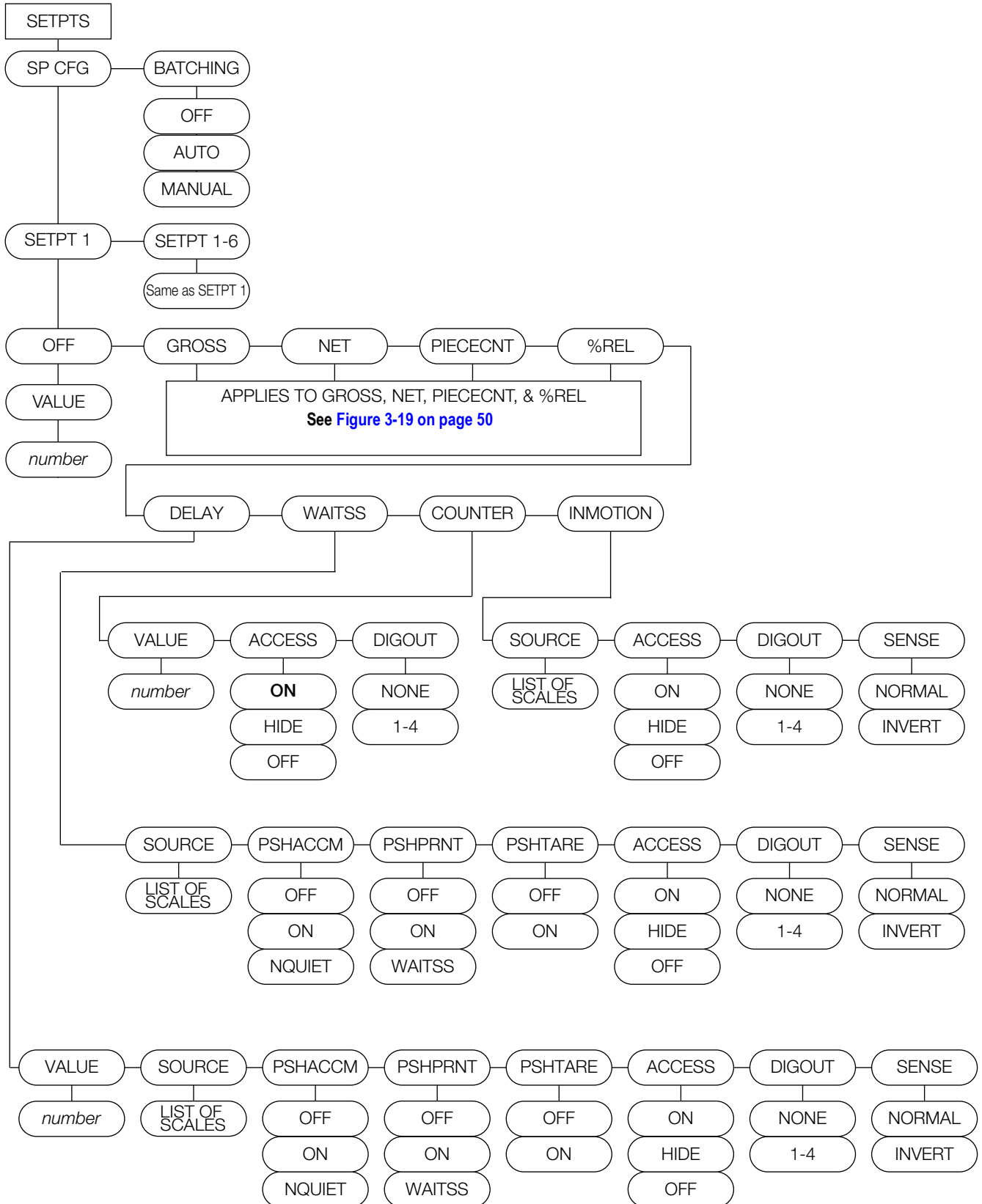

Figure 3-18. Setpoints Menu

Gross, Net, Piececnt, %REL Sub-menu

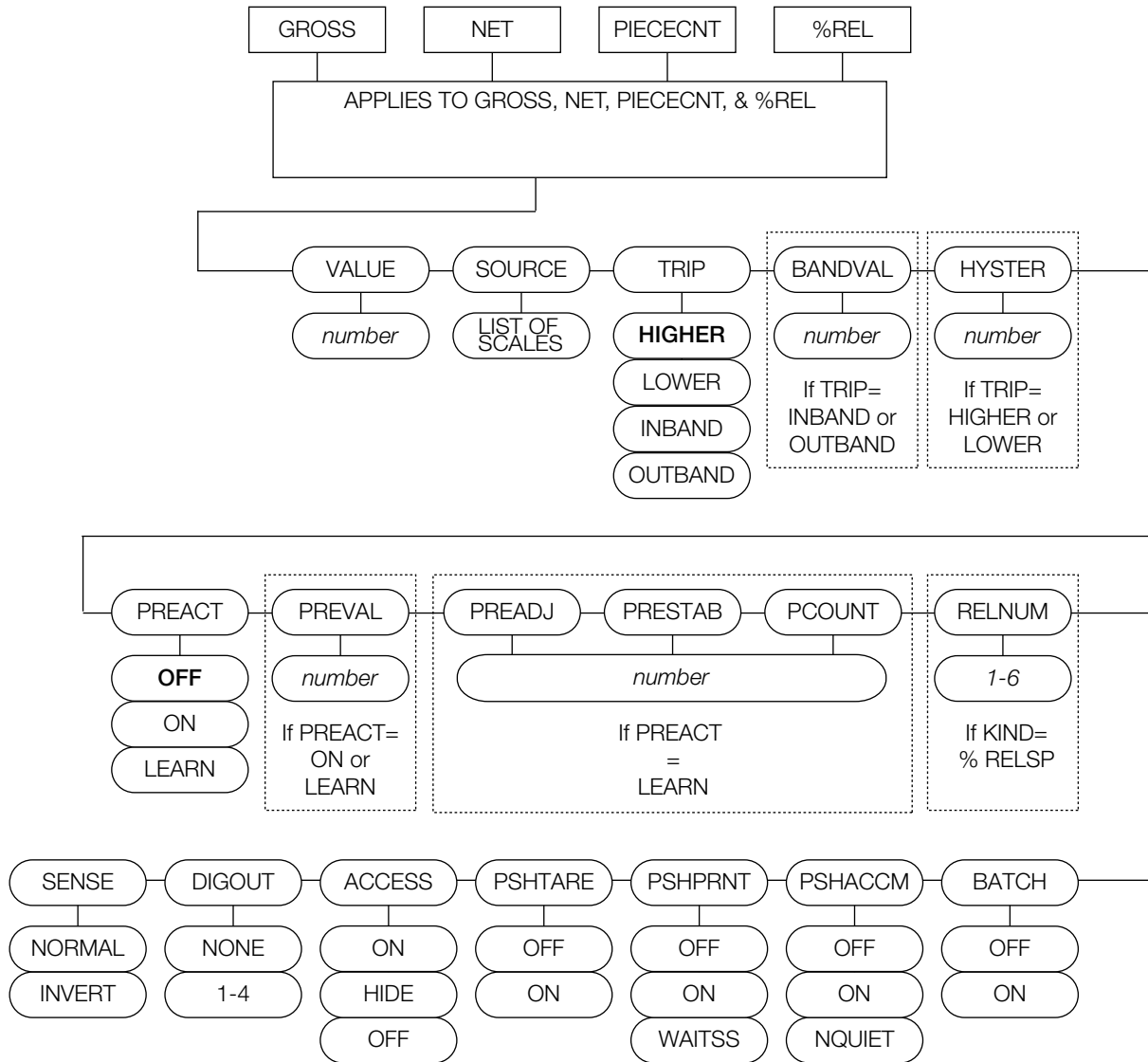

Figure 3-19. Gross, Net, Piecent, %REL Sub-menu

Parameters	Settings	Description
SP CFG	SETPT 1 SETPT 2-6	Specifies the settings for GROSS, NET, PIECECNT, % REL, delay, waitss, counter and inmotion used by setpoints 1 through 6
BATCHING	OFF AUTO MANUAL	Batching enable; Set to AUTO or MANUAL to allow a batch sequence to run; MANUAL requires a Batch Start softkey before the batch sequence can run; AUTO allows batch sequences to repeat continuously
SP CFG sub-menu		
SETPT1-6	OFF GROSS NET PIECECNT %REL DELAY WAITSS COUNTER INMOTION	Specifies the setpoint kind; GROSS, NET, PIECECNT, and %REL setpoint kinds can be used as either batch or continuous setpoints; DELAY, WAITSS, and COUNTER setpoint kinds can only be used in batch sequences; The INMOTION setpoint kind can only be used as a continuous setpoint

Table 3-17. Scale Setpoint Menu Parameters

Parameters	Settings	Description
Setpoint 1-6 sub-menu		
OFF	–	A setting of OFF disables the setpoint
GROSS NET PIECECNT %REL	Value Source Trip Bandval Hyster Preact Preval Preadj Prestab Pcount Relnum Batch Pshaccm Pshprint Pshtare Access Digout Sense	The GROSS, NET, PIECECNT, and %REL setpoints support the sub-parameters that are shown in the Settings column; See the section at the bottom of this table for information on the sub-parameters
DELAY	Value Source Pshaccm Pshprint Pshtare Access Digout Sense	The DELAY setpoint supports the sub-parameters that are shown in the Settings column; See the section at the bottom of this table for information on the sub-parameters
WAITSS	Source Pshaccm Pshprint Pshtare Access Digout Sense	The WAITSS setpoint supports the sub-parameters that are shown in the Settings column; See the section at the bottom of this table for information on the sub-parameters
COUNTER	Value Access Digout	The COUNTER setpoint supports the sub-parameters that are shown in the Settings column; See the section at the bottom of this table for information on the sub-parameters
INMOTION	Source Access Digout Sense	The INMOTION setpoint supports the sub-parameters that are shown in the Settings column; See the section at the bottom of this table for information on the sub-parameters
Off, Gross, Net, Piececnt, %Rel, Delay, Waitss, Counter and Inmotion sub-menus		
VALUE	Number	Setpoint value; For weight-based or piece-count-based setpoints: specifies the target weight value, 0–999999; For time-based setpoints: specifies, in 0.1-second intervals, a time value in the range 0–65535; For COUNTER setpoints: specifies the number of consecutive batches to be run, 0–65535
SOURCE	List of available scales	Specify the scale number used as the source for the setpoint
TRIP	Higher Lower Inband Outband	Specifies whether the setpoint is satisfied when the weight is higher or lower than the setpoint value, within a band established around the value, or outside of that band; In a batch sequence with TRIP = HIGHER, the associated digital output is active until the setpoint value is reached or exceeded; with TRIP = LOWER, the output is active until the weight goes below the setpoint value
BANDVAL	Number	For setpoints with TRIP=INBAND or OUTBAND, specifies a weight equal to half the band width; The band established around the setpoint value is VALUE ±BANDVAL
HYSTER	Number	Specifies a band around the setpoint value that must be exceeded before the setpoint, once off, can trip on again

Table 3-17. Scale Setpoint Menu Parameters (Continued)

Parameters	Settings	Description
PREACT	Off On Learn	Allows the digital output associated with a setpoint to shut off before the setpoint is satisfied to allow for material in suspension; The ON value adjusts the setpoint trip value up or down (depending on the TRIP parameter setting) from the setpoint value using a fixed value specified on the PREVAL parameter; The LEARN value can be used to automatically adjust the preact value after each batch; LEARN compares the actual value at standstill to the target setpoint value, and then adjusts the preact PREVAL by the PREADJ value times the difference after each batch
PREVAL	–	Specifies the preact value for setpoints with PREACT set to ON or LEARN; Depending on the TRIP setting specified for the setpoint, the setpoint trip value is adjusted up or down by the PREVAL value
PREADJ	0.500000 0-9999999	Preact adjustment factor; For setpoints with PREACT set to LEARN, specifies a decimal representation of the percentage of error correction applied (0.05 = 50%, 1.0 - 100%) each time a PREACT adjustment is made
PRESTAB	0 0-65535	Preact stabilization time-out; For setpoints with PREACT set to LEARN, specifies the time, in 0.1-second intervals, to wait for standstill before adjusting the PREACT value; Setting this parameter to a value greater than zero disables the learn process if standstill is not achieved in the specified interval
PCOUNT	1 0-65535	Preact learn interval; For setpoints with PREACT set to LEARN, specifies the number of batches after which the preact value is recalculated; The default value, 1, recalculates the preact value after every batch cycle
RELNUM	1 2 3 4 5 6	For the percent relative setpoint, specifies the number of the relative setpoint; The target weight for the %REL setpoint is determined as the percentage (specified on the VALUE parameter of the %REL setpoint) of the target value of the relative setpoint
BATCH	Off On	Specifies whether the setpoint is used as a batch (ON) or continuous (OFF) setpoint
PSHACCM	Off On ONquiet	Specify ON to update the accumulator and perform a print operation when the setpoint is satisfied; Specify ONQUIET to update the accumulator without printing
PSHPRNT	Off On Waitss	Specify ON to perform a print operation when the setpoint is satisfied; Specify WAITSS to wait for standstill after setpoint is satisfied before printing
PSHTARE	Off On	Specify ON to perform an acquire tare operation when the setpoint is satisfied NOTE: PSHTARE acquires tare regardless of value specified for the REGULAT parameter on the FEATUR menu.
ACCESS	On Hide Off	Specifies the access allowed to setpoint parameters shown by pressing the Setpoint softkey in normal mode; ON: Values can be displayed and changed; HIDE: Values cannot be displayed or changed; OFF: Values can be displayed but not changed
DIGOUT	None 1-4	Lists all digital output bits available; This parameter is used to specify the digital output bit associated with this setpoint; Use the DIGI/O menu to assign bit function to OUTPUT; For continuous setpoints, the digital output becomes active (low) when the condition is met; For batch setpoints, the digital output is active until the setpoint condition is met
SENSE	Normal Invert	Specifies whether the value of the digital output associated with this setpoint is inverted when the setpoint is satisfied

Table 3-17. Scale Setpoint Menu Parameters (Continued)

3.7.7 DIG I/O Menu

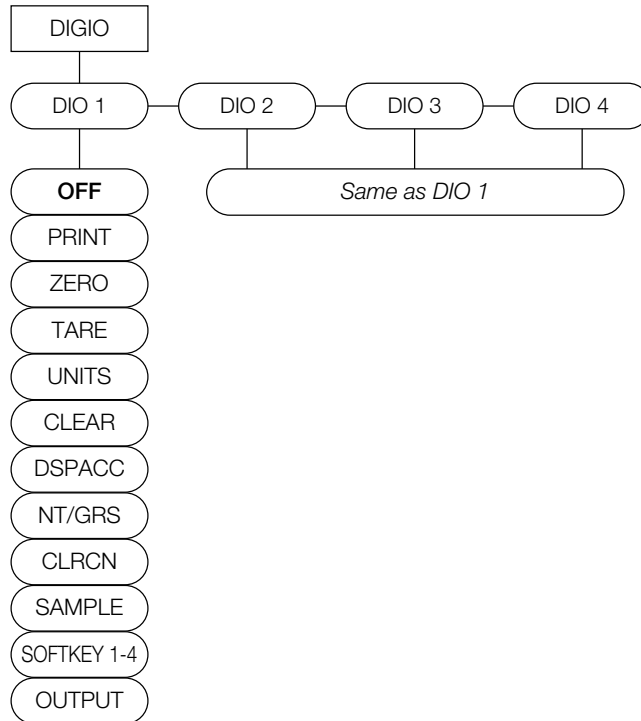

Figure 3-20. Digital I/O Menu Layout

Parameter	Settings	Description
DIG IO	DIO 1 DIO 2 DIO 3 DIO 4	Assign digital input/output functions
DIO 1-4 sub-menu		
DIO 1-4	OFF PRINT ZERO TARE UNITS CLEAR DSPACC NT/GRS CLRCN SAMPLE SFTKEY1 SFTKEY2 SFTKEY3 SFTKEY4 OUTPUT	OFF - Indicates the DIO bit is not configured PRINT - Provides the same function as the front panel Print key ZERO - Provides the same function as the front panel Zero key TARE - Provides the same function as the front panel Tare key UNITS - Provides the same function as the front panel Units key CLEAR - Provides the same function as the front panel CLR key DSPACC - Displays the accumulator for the current scale NT/GRS - Provides the same function as the front panel Gross/Net key CLRCN - Resets the consecutive numbering to the value specified in Consecutive Number Start SAMPLE - Provides the same function as the front panel Sample key SFTKEY1 - Provides the same function as the front panel Softkey 1 SFTKEY2 - Provides the same function as the front panel Softkey 2 SFTKEY3 - Provides the same function as the front panel Softkey 3 SFTKEY4 - Provides the same function as the front panel Softkey 4 OUTPUT - Assigns the bit as a digital output for setpoint use

Table 3-18. Digital I/O Menu Parameters

3.7.8 Version Menu

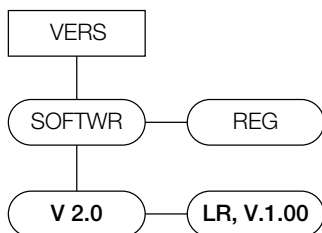

Figure 3-21. Version Menu Layout

Parameter	Settings	Description
VERS	SOFTWR	Software version. 2.xx
	REG	Regulatory version. LR, V 1.XX

Table 3-19. Version Menu Parameters

3.8 Test Menu

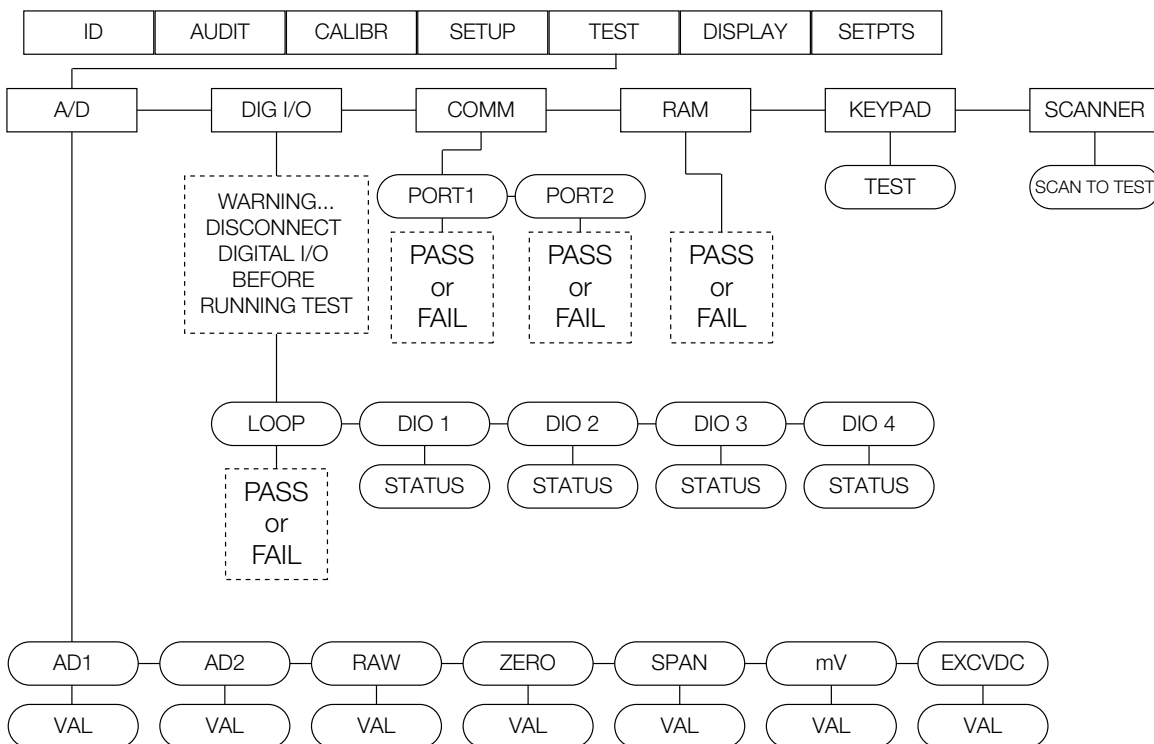

Figure 3-22. Test Menu

Parameter	Settings	Description
A/D	AD1 AD2 EXCVDC	Gives details of current or live A/D counts as well as stored zero and span A/D values; Shows voltage levels for signal and excitation voltages
DIG I/O	LOOP DIO 1 DIO 2 DIO 3 DIO 4	Tests digital I/O ports; If they are functioning, PASS displays; If they are not functioning, FAIL displays; Note: Both inputs and outputs are active low. They go to a ground state when active. The I/O ports become activated when the test is performed. Make sure any equipment is disconnected prior to performing this test to avoid inadvertently activating it.
COMM	PORT1 PORT2	Performs a loop-back test on the serial ports; If they are functioning, PASS displays; If not functioning, FAIL displays
RAM	TEST	Tests the unit's memory; If it is functioning, PASS displays; If it is not functioning, FAIL displays

Table 3-20. Test Menu Parameters

Parameter	Settings	Description
KEYPAD	TEST	Tests the unit's individual keypad buttons by displaying the name of the key pressed; If nothing displays, the key is not functioning; Press the Menu key to exit the test;
SCANNER	TEST	Displays scanned value with control characters
A/D sub-menus		
RAW	VAL	Displays the live raw AD count
ZERO	VAL	Displays the captured AD Zero calibration value
SPAN	VAL	Displays the captured AD Span calibration value
mV	VAL	Displays the live millivolt signal voltage
EXCADC	VAL	Displays the excitation voltage
LOOP	TEST	Performs a loop test on dig I/O cards
DIO 1 DIO 2 DIO 3 DIO 4	STATUS	Displays the status of each individual digital I/O port; If set as input, the display shows input stats IN HI or IN LO; If set as output, pressing Enter toggles the output between HI and LO. OUT HI or OUT LO; OUT LO is active
PORT1 PORT2	TEST	Performs a loopback test on serial port 1 or 2; Connect a wire between TX and RX on port 1 or port 2 before testing

Table 3-20. Test Menu Parameters (Continued)

3.9 Display Menu

There are three display settings on the Counterpart.

Setting the display parameters from this top level menu is temporary. After a power cycle, the values will revert to their previous values. Changes made to these parameters through the CONFIG menu are kept through a power cycle.

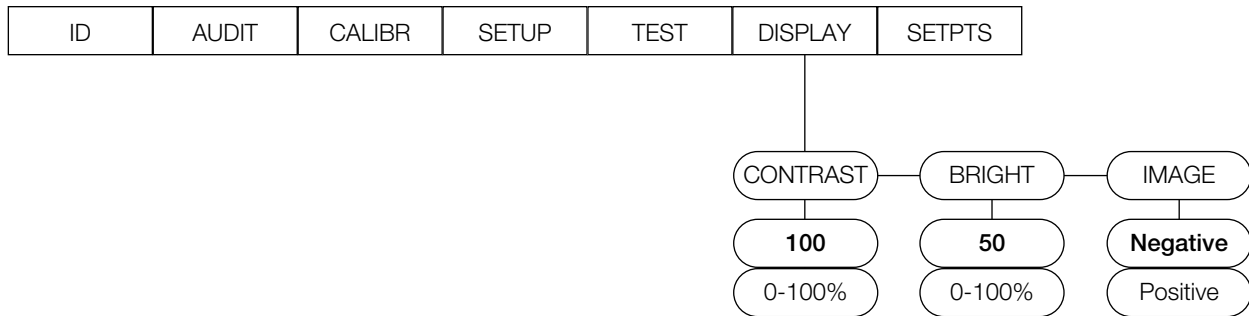

Figure 3-23. DISPLAY Menu

Parameter	Settings	Description
Contrast	100 0-100%	Adjust the contrast of the unit display
Bright	50 0-100%	Adjust the brightness of the unit display
Image	Negative Positive	Adjust the image of the unit display

Table 3-21. Display Menu Parameters

3.10 Setpoints – Weigh Mode Parameter Menu

Set up of setpoints is allowed while in the weigh mode.

While setting up setpoints, the Access parameter needs to be set to either On or Off.

- Setting it to **On** allows a setpoint to be viewed and edited if setpoint type is Gross, Net, Piececnt, %Rel, Delay, or Counter
- Setting it to **off** allows a setpoint to be viewed but not edited if the setpoint type is Gross, Net, Piececnt, %Rel, Delay, or Counter
- Hide will not show the setpoint

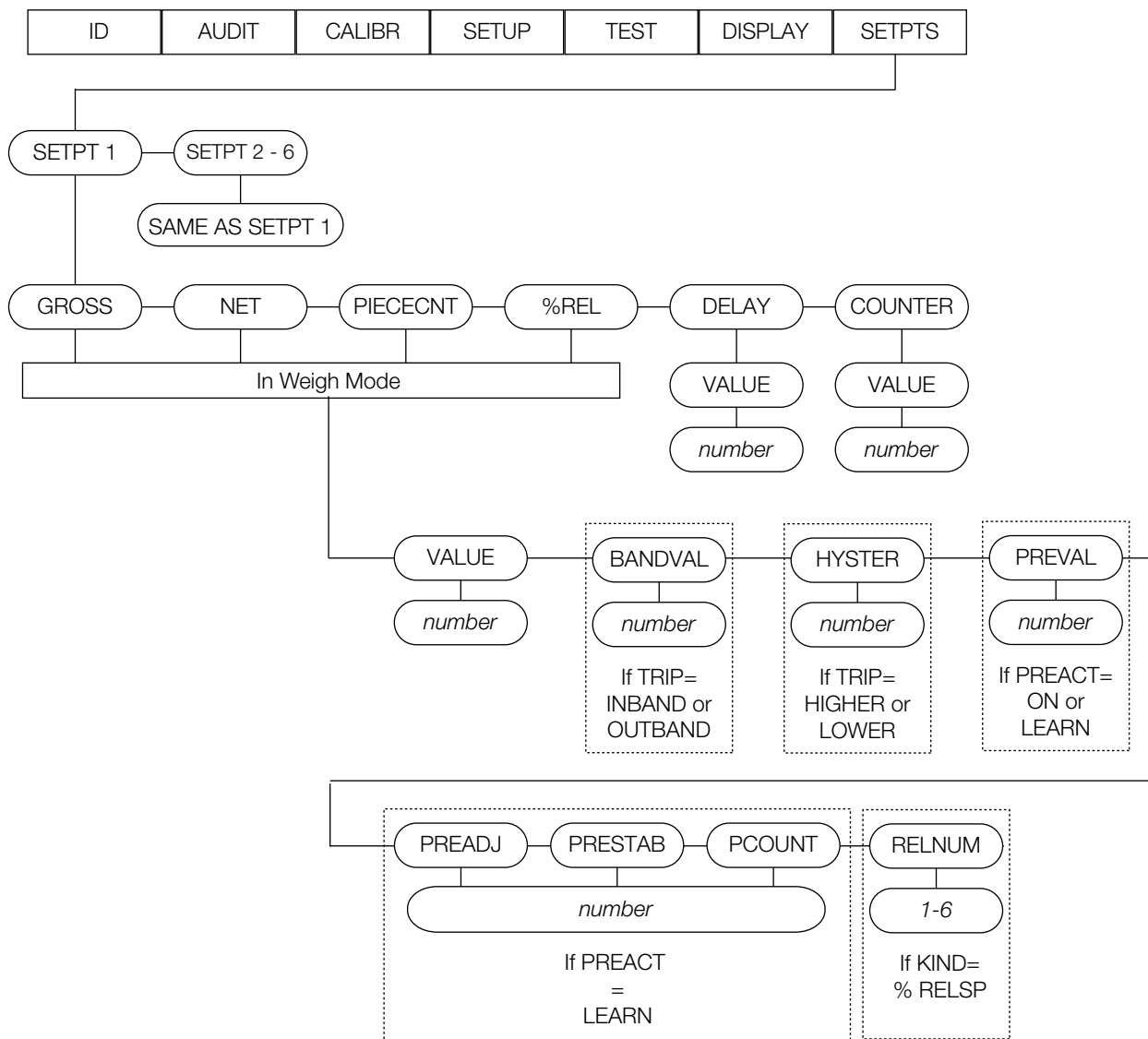

Figure 3-24. Weigh Mode Menu

Parameters	Settings	Description
SETPT1-6	OFF GROSS NET PIECECNT %REL DELAY WAITSS COUNTER INMOTION	Specifies the setpoint kind; GROSS, NET, PIECECNT, and %REL setpoint kinds can be used as either batch or continuous setpoints; DELAY, WAITSS, and COUNTER setpoint kinds can only be used in batch sequences; The INMOTION setpoint kind can only be used as a continuous setpoint
Setpoint 1-6 sub-menus		
GROSS NET PIECECNT %REL	Value Source Trip Bandval Hyster Preact Preval Preadj Prestab Pcount Relnum Batch Pshaccm Pshprint Pshtare Access Digout Sense	The GROSS, NET, PIECECNT, and %REL setpoints support the sub-parameters that are shown in the Settings column; See the section at the bottom of this table for information on the sub-parameters
DELAY	Value Source Pshaccm Pshprint Pshtare Access Digout Sense	The DELAY setpoint supports the sub-parameters that are shown in the Settings column; See the section at the bottom of this table for information on the sub-parameters
COUNTER	Value Access Digout	The COUNTER setpoint supports the sub-parameters that are shown in the Settings column; See the section at the bottom of this table for information on the sub-parameters
Gross, Net, Piececnt, %Rel, Delay and Counter sub-menus		
VALUE	Number	Setpoint value; for weight-based or piece-count-based setpoints: specifies the target weight value, 0–999999; For time-based setpoints: specifies, in 0.1-second intervals, a time value in the range 0–65535; For COUNTER setpoints: specifies the number of consecutive batches to be run, 0–65535
BANDVAL	Number	For setpoints with TRIP=INBAND or OUTBAND, specifies a weight equal to half the band width; The band established around the setpoint value is VALUE ±BANDVAL
HYSTER	Number	Specifies a band around the setpoint value that must be exceeded before the setpoint, once off, can trip on again
PREVAL	Number	Specifies the preact value for setpoints with PRACT set to ON or LEARN; Depending on the TRIP setting specified for the setpoint, the setpoint trip value is adjusted up or down by the PREVAL value
PREADJ	0.500000 0-9999999	Preact adjustment factor; For setpoints with PRACT set to LEARN, specifies a decimal representation of the percentage of error correction applied (0.05 = 50%, 1.0 = 100%) each time a PRACT adjustment is made
PRESTAB	0 0-65535	Preact stabilization time-out; For setpoints with PRACT set to LEARN, specifies the time, in 0.1-second intervals, to wait for standstill before adjusting the PRACT value; Setting this parameter to a value greater than zero disables the learn process if standstill is not achieved in the specified interval
PCOUNT	1 0-65535	Preact learn interval; For setpoints with PRACT set to LEARN, specifies the number of batches after which the preact value is recalculated; The default value, 1, recalculates the preact value after every batch cycle
RELNUM	1 2 3 4 5 6	For the percent relative setpoint, specifies the number of the relative setpoint; The target weight for the %REL setpoint is determined as the percentage (specified on the VALUE parameter of the %REL setpoint) of the target value of the relative setpoint

Table 3-22. Setpoint Menu Parameters in Weigh Mode

4.0 Calibration

The Counterpart can be calibrated using the front panel, EDP commands, or Revolution.

NOTE: Calibration can be performed in two places within the menu: the CALIBR menu shown in Figure 4-1 and the SCALE sub-menu shown in Figure 3-7 on page 33. CALIBR menu in Figure 4-1 is a “quick access” calibration. For an in-depth scale setup and calibration, use the menus found under SETUP/CONFIG/SCALE (Figure 3-7 on page 33).

Calibration consists of the following steps:

- Zero calibration
- Entering the test weight value
- Span calibration
- Optional five-point linearization
- Optional rezero calibration for test weights using hooks or chains

NOTE: The Counterpart requires the WZERO and WSPAN points to be calibrated. The linearity points are optional, but must not duplicate zero or span. During calibration, the  acts as a data entry confirmation key. The soft calibrate key accepts that value.

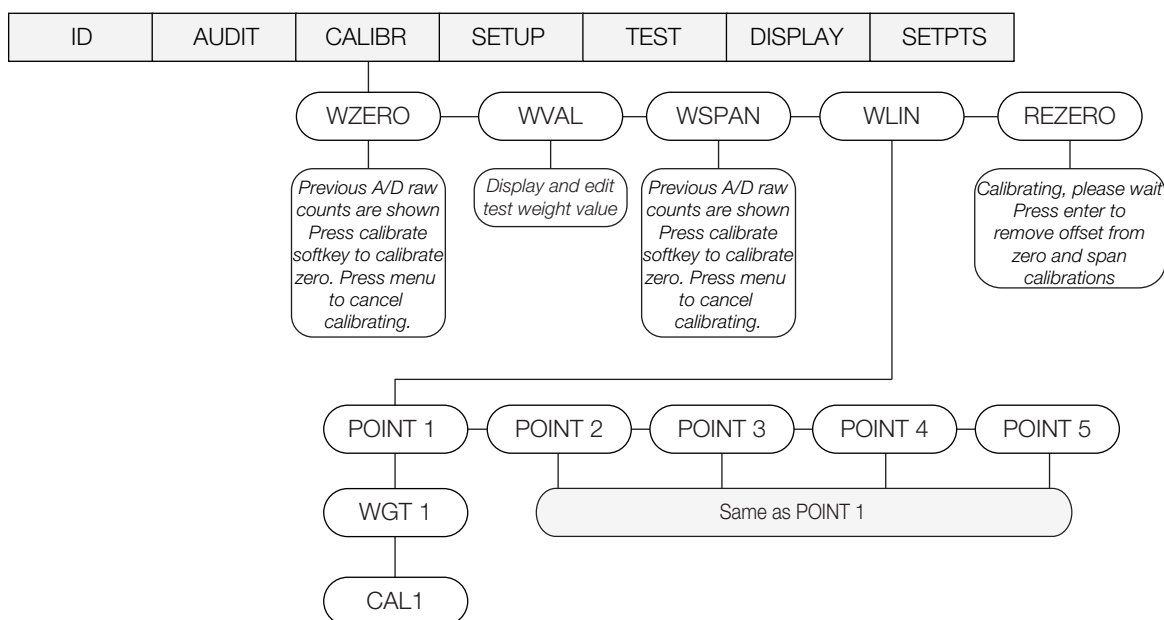













Figure 4-1. Calibration (CALIBR) Menu

4.1 Front Panel Calibration



1. Press , and then press  until the display reads **CALIBR**.
2. Press  or  to go to the scale to be calibrated. Press  or  to go to **WZERO**. Press  again to display a value and **press the Calibrate softkey to Calibrate WZERO**.

NOTE: To end the zero calibration, press Menu to exit. No changes will be made to the current calibration.

3. The indicator displays **CALIBRATING** while calibration is in progress. When complete, press  or  to advance to the next prompt (**WVAL**).



NOTE: To view new AD count, repeat Step 3, but instead of pressing  while viewing the value, press  to exit.

4. With **WVAL** displayed, press  or  to display or edit the stored calibration weight value. Press  to store the **WVAL** value and advance to **WSPAN**.

- With **WSPAN** displayed, press  or  to view the A/D count. Place test weights on the scale equal to **WVAL**. Press the **Calibrate** softkey to calibrate **WSPAN**.



NOTE: To end the calibration span, press **Menu** to exit. No changes will be made to the current calibration.

- After the **Calibrate** softkey is pressed, the indicator displays **CALIBRATING** when complete. Press  or  and the **Save Exit** softkey or proceed to **WLIN**.



NOTE: To view the new AD count, navigate back to the **WSPAN**, and repeat [Step 6](#); however, instead of pressing the **Calibrate** softkey while viewing the value, press **Save/Exit** to exit.

4.2 Five-point Linearization

Five-point linearization (using the **WLIN** parameter) provides increased scale accuracy by calibrating the indicator at up to five additional points between the zero and span calibrations.

Linearization is optional: To not perform linearization, skip the **WLIN** parameter; if linearization values have previously been entered, these values are reset to zero during calibration. **WZERO** and **WSPAN** must be calibrated before adding linearization points; **WLIN** values must be less than the **WSPAN** value and must not duplicate **WZERO** or **WSPAN**.

To perform linearization, follow the procedure below:

With **WLIN** displayed, press **Down** to go to the first linearization point (**POINT 1**) and then press **Down** again to show the weight value prompt (**WGT 1**). Then press **Down** to show the weight value. Place test weights on the scale, and use the numeric keypad to enter the actual test weight value. Press **Enter** to save the value and move to the calibration (**CAL 1**) prompt. Press **down** to show the current calibration value, and then press the **Calibrate** softkey to calibrate the linearization point. When complete, the AD count for the linear calibration displays. Press **Enter** again to save calibration value and go to the next prompt (**POINT 2**).

Repeat for up to five linearization points. To exit the linearization parameters, press the **Up** key to return to **WLIN**.

4.3 Rezero

The optional rezero function is used to remove a calibration offset when hooks or chains are used to hang the test weights.



NOTE: The rezero function cannot be used with five-point linear calibration.

If no other apparatus was used to hang the test weights during calibration, remove the test weights and press **Up** to return to the **CALIBR** sub-menu.

If hooks or chains were used during calibration, remove these and the test weights from the scale. With all weight removed, go to the **REZERO** parameter, and press **Down** to show the current zero value. Press the **Calibrate** softkey to adjust the zero and span calibration values. Press **enter** or **Up** to return to the **CALIBR** sub-menu.

Press **Up** to return to the **SCALES** menu, or press the **Save and Exit** softkey to exit setup mode.

4.4 EDP Command Calibration

To calibrate the indicator using EDP commands, the indicator EDP port must be connected to a terminal or personal computer. See [Section 2.8.1 on page 18](#) for EDP port pin assignments.

Once the indicator is connected to the sending device, do the following:

- Place the indicator in config mode (display must read **SCALE** — see [Figure 3-7 on page 33](#)) and remove all weight from the scale platform. For test weights that require hooks or chains, place the hooks or chains on the scale for zero calibration.
- Send the **SC.WZERO#n** command to calibrate zero. The indicator displays **CALIBRATING** while calibration is in progress.
- Place test weights on the scale and use the **SC.WVAL#n** command to enter the test weight value in the following format:

SC.WVAL=nnnnnn<CR>

- Send the **SC.WSPAN#n** command to calibrate span. The indicator displays **CALIBRATING** while calibration is in progress.

- Up to five linearization points can be calibrated between the zero and span calibration values. Use the following commands to set and calibrate a single linearization point:

SC.WLIN.V1=nnnnn<CR>

SC.WLIN.C1<CR>

The SC.WLIN.V1#*n* command sets the test weight value (nnnnn) for linearization point 1. The SC.WLIN.C1#*n* command calibrates the point. Repeat using the SC.WLIN.V*x* and SC.WLIN.C*x* commands as required for additional linearization points.

- To remove an offset value, clear all weight from the scale, including hooks or chains used to hang test weights, and send the SC.REZERO#*n* command. The indicator displays **CALIBRATING** while the zero and span calibrations are adjusted.
- Send the SC.KUPARROW#*n* or the SC.KEXIT#*n* EDP command to return to normal mode.

4.5 Revolution Calibration

To calibrate the indicator using Revolution, the indicator EDP port must be connected to a PC running the Revolution configuration utility.

- Place indicator in config mode. **SCALE** displays (Figure 3-7 on page 33). Remove all weight from scale platform.
- From Revolution, select **File » New**. The *Select Indicator* dialog box appears.
- Select Counterpart and click **OK**.
- From the Communications menu, select **Connect**.
- From the left pane, expand the *Scale* selection and click the **Scale** button.

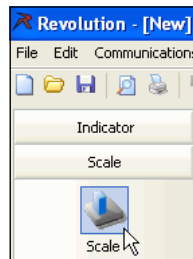

Figure 4-2. Scale Button

- From the *Tools* menu, select **Calibration Wizard**.
- Click **NEXT** to begin the Calibration Wizard.
- Select between a standard calibration or a standard with multi-point linearization and click **NEXT**.
- In the text box, enter the test weight value to be used for span calibration.
- Select the check box if using chains or hooks during the calibration, and click **NEXT**.
- Remove all weight from the scale and click **Click to Calibrate Zero** to begin zero calibration. For test weights that require hooks or chains, place them on the scale for zero calibration.
- When zero calibration is complete, the Calibration Wizard prompts user to place test weights on the scale. Place the test weights on the scale and click **Click to Calibrate Span**.
- To perform linear calibration, the Calibration Wizard now displays prompts (1–5). Enter the weight value for Linear Point #1, place test weights on scale, and click **GO**. Repeat for additional linearization points and click **NEXT**.
- The new and old calibration settings are displayed. To accept the new values, click **Finish**. To exit and restore the old values, click **Cancel**.

4.6 More About Calibration

The following provides additional information about compensating for environmental factors (Section 4.6.1) and also provides diagnostic information for determining expected zero and span coefficients.

4.6.1 Adjusting Final Calibration

Calibration may be affected by environmental factors including wind, vibration, and angular loading. For example, if the scale is calibrated with 1000 lb, a strain test may determine that at 2000 lb the calibration is 3 lb high. In this case, final calibration can be adjusted by tweaking **WVAL** to 998.5 lb. This adjustment provides a linear correction of 1.5 lb per 1000 lb.

To adjust the final calibration, return to the **WVAL** prompt and press **TARE** to show the test weight value. Press **ZERO** and **GROSS NET** to adjust calibration up or down. Press the **Calibrate** softkey to save the value, and press **ZERO** to return to the **CALIBR** menu.

5.0 Scale Operations

The following contains detailed operator instructions for Counterpart, including instructions on how to enter tare weights, toggle between net and gross weight, enter unit weights, perform inventory accumulation and reduction and toggle between scales. All operator instructions are conducted with the scale in the operation mode that is the weighing or normal mode.

Counting scale accuracy is determined by:

- Sample size (number of pieces)
- Total sample size as a percentage of full scale capacity
- Piece-to-piece weight variation

As a general rule when determining sample size of fairly uniform pieces, the larger the sample size, the greater the total sample weight, and therefore, the better the counting accuracy. Selecting the smallest capacity scale that can obtain the highest counting resolution should be considered, but should not sacrifice the capacity required for the heaviest container of parts. For this kind of application, a dual-platform scale may be the best selection. There is a direct relationship between piece-to-piece weight variation (non-uniformity) and counting accuracy.

Therefore, elimination of the piece-to-piece weight variations can be accomplished by:

1. Isolating the sample used to calculate the unit weight and using the same sample to re-check the scale.
2. Recalculating the unit weight from lot-to-lot of parts. Parts manufactured on one machine may vary slightly from another machine relative to weight.
3. Tightening the manufacturing tolerances on the parts reduces piece weight variations and increases count accuracy.

The Stand-by Display

At the stand-by display the **WEIGHT**, **UNIT WEIGHT**, and **QUANTITY** displays show zeros and the annunciator for the platform is illuminated (Scale 1 or 2).



5.1 Weight Unit Switching

The weight units displayed can be changed between primary, secondary and tertiary units during weighing operations by pressing .



5.2 Entering Tare Weights

Tare weights can be entered in the scale by one of two methods: one-touch tare or digital tare. Digital tare is used when the tare weight is already known while one-touch tare is used when the tare weight is unknown. When an Item Code already programmed into the Counterpart memory is called up and it has a tare weight stored for that Item Code, the tare weight stored with the Item Code will override one entered digitally or by using .

5.2.1 One-Touch Tare, Tare Unknown

1. If the tare weight value is not known, place the item to be tared on the scale and press . The weight display should now show **0** and the **Net** annunciator should illuminate.
2. Remove the item from the scale. The weight display should show a negative weight value (weight of the tared container, box, or item).
3. To clear the tare weight, press  with no weight on the scale. The scale should be at gross zero. The **Net** annunciator will no longer be illuminated.

5.2.2 Digital Tare, Tare Weight Known

1. If the tare weight value is known, use the numeric keypad to key in the value and then press . The **Net** annunciator will illuminate.
2. To reset the tare to zero, press  again with no weight on the scale while the scale is at gross zero and the **Zero** annunciator is lit.

5.3 Toggling Between Gross and Net

To toggle between net and gross weight, a tare value must be entered into the scale.

See [Section 5.2 on page 61](#) to enter a tare value.

After a tare value is entered into the scale, items placed on the scale will cause the **Net** annunciator to illuminate and allow toggling between net weight and gross weight. For example:

1. Place 0.5 lb weight on the scale and then press . The weight display should show 0.000 lb.
2. Place another 0.5 lb weight on the scale. The scale weight display should show 0.500 and the **Net** annunciator should be illuminated.
3. Press the **GROSS/NET** key. The weight display should show 1.000 GROSS WEIGHT, and the **Net** annunciator will no longer be illuminated.
4. Press the **GROSS/NET** key. The weight display should show 0.500 and the **Net** weight annunciator should be illuminated again.

5.4 Entering Unit Weights

Entering unit weights can be done either by sampling, as presented in [Section 5.4.1 on page 63](#), or by key entry as described in [Section 5.4.2 on page 63](#), or scanned from a barcode ([Section 5.12 on page 73](#)).



NOTE: EXTENT OF INSUFFICIENT SAMPLES controls unit weight sampling. The default setting for the INFSMPLE is 0.1%.

SAMPLE QUANTITY determines the number of pieces the scale assumes are on the platter when pressing  to calculate the unit weight. The default setting is 10 pieces.

XFRUNITWT sets whether unit weight determined by sampling is automatically transferred from Scale 1 to Scale 2. The default setting is AUTOMATIC.

UNIT WEIGHT BASE controls whether the unit weight displays per 1000 pieces or per 1 piece. The default setting for this is 1000 pieces.

Unit Weight Per 1000 Pieces vs. Unit Weight Per 1 Piece

The scale's internal microprocessor calculates unit weights to several decimal places. However, the scale display generally can only show unit weight to a maximum of 8 characters (or 7 places and a decimal point). If this unit weight is recorded from the scale display and entered by key entry, this can introduce errors in the unit weight and consequently in the counts.

This error increases as the unit weight of the parts being counted decreases.

Example: A sample of 10 zener diodes is placed on the scale. The unit weight is computed to be 0.000653642 lbs.

However, the scale has a 7 character display for unit weight (or 6 places after the decimal point — 0.000653) so the scale can only display 0.000653 as the unit weight. If this unit weight were recorded and keyboard entered in future counting operations, the resulting error would be:

$$\left(\frac{0.000653642 - 0.000653 \times 100}{0.000653642} \right) = 0.098\%$$

On the other hand, with entry of the unit weight as “weight per 1000 pieces” the decimal place is, in effect, moved three places to the right, allowing 3 more decimal places of accuracy. In this example, the entry would be made as 0.653642 per 1000 pieces, eliminating the error.

As a practical note, entering unit weights per 1000 pieces also lessens the chances of entering the wrong number of zeros when keying in weights with many leading zeros. Incorrect entry of unit weights is a common cause of inaccurate counting.

In the following example, unit weight per 1 piece is generally used:

When working with other existing systems or procedures that are already set up to record unit weight per piece such as inventory systems or labeling requirements.

5.4.1 Unit Weight Operation by Sampling

Unit weight operation by sampling is accomplished by placing a 10 piece sample on the scale and then pressing .

The scale calculates a unit weight based on the weight of the sample. The following details the procedure with UNIT WEIGHT UPDATE set at either on or off.

Default settings are placed at 10 pieces. To use an arbitrary sample size, key in the quantity and .

Unit Weight Update Set to Off (Default)

Parts can be sampled (generating a new unit weight) or a unit weight can be scanned, but the new unit weight is not saved into the stored copy of the loaded ID record.

Unit Weight Update Set to On

Parts can be sampled (generating a new unit weight) or a unit weight can be keyed or scanned and the new unit weight is saved into the stored copy of the currently loaded ID record. If WeighVault is also enabled, a WeighVault ID update will also occur.

Piece Weight Enhancement

After performing a sample process, the unit determines the maximum number of pieces that could be accurately used for a recompute. If the number of pieces on the scale is less than the recompute value, the RECOMP annunciator will be shown.

1. Place items to be counted on the scale platter; make sure the **RECOMP** annunciator is still on.
2. Press  while the **RECOMP** annunciator is shown. This will start a sample process using the current piece count (instead of the SAMPLEQTY value) as the sample quantity.

5.4.2 Unit Weight Operation by Key Entry

Unit weight operation by key entry is accomplished by using the numeric keypad to enter the known value of the unit weight and then pressing the UNIT WEIGHT key. For example:

1. With Counterpart in Weighing mode, enter the known unit weight of 200.00 using the keyboard.
2. Press the UNIT WEIGHT key to enter the unit weight.
3. Place a 2 lb weight on the scale. The weight display reads 2.000, the unit weight display reads 200.00, and the quantity display reads 10.

The unit weight must be entered as either APW (average piece weight) or unit weight per thousand depending on the setting of the Unit Weight Base (UTWTBASE) parameter.



NOTE: To clear the unit weight value, enter 0 and push the Unit Weight key.

Unit Weight Update Set to Off (Default)

Parts can be sampled (generating a new unit weight) or a unit weight can be scanned, but the new unit weight is not saved into the stored copy of the loaded ID record.

Unit Weight Update Set to On

Parts can be sampled (generating a new unit weight) or a unit weight can be keyed or scanned and the new unit weight is saved into the stored copy of the currently loaded ID record. If WeighVault is also enabled, a WeighVault ID update will also occur.

5.5 Negative Counting (Full Box Counting)

Just as counting can be done by adding parts to the scale, counting can be done by removing parts from the scale. This is called “negative counting” because a negative weight displays while counting. This procedure does not affect the inventory quantity for this item stored in the scale.







NOTE: To utilize the negative counting feature, set **NEGCOUNT** to “On” under the Count Menu and the regulatory mode must be set to Industrial.

There are two ways to perform negative counting depending on whether the user wants to see the total amount remaining in the container or the total amount removed from the container.



5.5.1 Counting Out of a Full Container — See Total Amount Remaining in the Container

To carry out this operation, the tare weight must be known ahead of time.

1. Place the full container on the scale then press .
2. Remove a 10 piece sample from the container and press . After the unit weight has been calculated, return the sample to the container.
3. To see how many are still in the bin, the tare weight of the bin or container must be known. After removing any unwanted parts out of the bin, enter the tare weight of the bin and press . The scale will display how many parts were left in the bin. To print a label to put on the bin showing the total quantity in the bin, press .

5.5.2 Negative Counting — Total Removed Displayed at the End

With this procedure, count can be done accurately out of a full container for kitting or shipping without having to know the tare weight of the container.

1. Place a full container on the scale and press .
2. Remove a 10 piece sample from the container and press . After the unit weight has been calculated, return the sample to the container.
3. Remove the number of pieces needed for kitting or shipping. The amount removed will be displayed. If a label is needed for each kit or container, press  after removing each batch of pieces.

5.6 IDs

IDs are used to save and recall previously set codes, descriptions, unit weight, and tare preferences. The Counterpart has the capacity to store up to 150 individual IDs. There are three ways IDs can be entered and set:

1. Setting an ID Using the Normal Mode (Section 5.6.1)
2. Through Count Mode (Section 5.6.5 on page 66)
3. Through Revolution (Section 5.6.6 on page 67)

To enter alpha ID characters, double press the numeric keypad to obtain alpha characters (Section 1.9 on page 10).

To store more than 150 IDs, WeighVault is required (Section 5.7 on page 68).

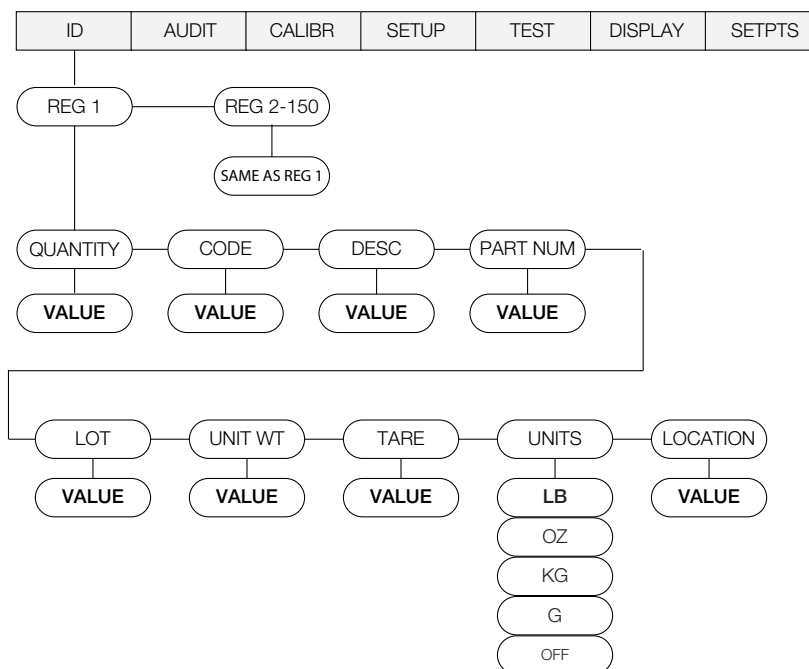







Figure 5-1. ID Menu



5.6.1 Setting an ID Using the Normal Mode

1. Press  to access this menu.
2. Press  to ID and then press  to get to REG1.
3. Navigate to the REG number wanted, to set (1-150) by using the  and  keys.



 **NOTE:** All menus have wrap-around functionality. If at ID1 and want to access ID150, one can quickly do so by moving backwards through the menu.

4. When the REG number desired is reached, to set, press  to select that register number.
5. Press  and enter the CODE value — either numeric or alphanumeric is acceptable. Thirty two characters can be entered and only 25 characters maximum for default barcode formats. This code will be used to recall the ID.
6. When the desired value is entered, press .
7. Enter the information for description, part number, lot number, unit weight, tare with all entries being optional.
8. Press  again to accept the value(s).
9. Press  to advance back up to REG. Press  again, and the **DONE** softkey displays.
10. When complete, push the **DONE** softkey.



Enter Lot Number — Optional

1. **LOT** will be displayed. Press  key to enter the alphanumeric value using the Counterpart keypad.
2. Press  to accept.



Enter Unit Weight — Optional

1. **UNIT WT** will be displayed. Press  and enter the unit weight value using the Counterpart keypad.
2. Press  to accept.

Enter Tare — Optional

1. **TARE** will be displayed. Press  and enter the tare value using the Counterpart keypad.
2. Press  to accept.

Enter Units — Optional

1. **UNITS** will be displayed. To adjust the units, use  and  to adjust the selection or press  to view the current setting.
2. Use  or  to store the setting.

Enter Location — Optional

1. **LOCATION** displays. Press  then enter a value. Push  to store.

5.6.2 Using a Stored ID

1. Press the **CODE** (*softkey needs to be set up*) softkey.
2. Counterpart responds with a code #=> prompt. Enter the **ID** code.
3. Press .



NOTE: Press code and then enter a zero to unload an ID code.

5.6.3 Using ID/Codes that are not Stored

1. Enable **Single ID** under feature menu.
2. Setup softkeys for code and other information to be printed, including part #, description, and/or quantity.
3. Press **Softkey**.
4. Key in value or information and press .
5. The clear unit weight (CLRUW) softkey may be set up to clear unit weight.
6. Next ID/code overrides data.

5.6.4 Clearing an ID

1. Press .
2. Toggle through menu items to **ID**.
3. Select **Reg 1-150** to clear.
4. Push the **Clear ID** softkey.
5. The display prompts **Clear ID Values**. Press the **Yes** softkey.
6. Display shows **ID Cleared**.
7. Push the **Menu** softkey to return to the Use mode.

5.6.5 Adding an ID From Count Mode

1. Press the **CODE** softkey.
2. Key in the ID number. The Alpha **ON/OFF** Softkey appears to allow number only entry.
3. If the ID number is not already in the database, Counterpart prompts, **Not Found, Save as New ID?**
4. Select Yes or No. By selecting Yes, Counterpart will store that ID code into the first open register. By selecting No, it will go back to the Counting mode display.
5. Optional – **Sample Quantity** desired and press the **UW Update** softkey
6. Optional – Tare the container and push the **Tare Update** softkey.

5.6.6 Adding an ID Through Revolution

To add an ID using Revolution, Revolution must be installed on the computer. Visit www.ricelake.com to download this free configuration software.

1. Unplug power to Counterpart.
2. Wire cable between computer and Counterpart.
3. Plug in power to Counterpart and press .
4. Open Revolution and go to Base Configuration, >> IDs.
5. To upload IDs from Counterpart, select **Connect** from the Toolbar or under **Communications — Connect**.
6. Select **Communications** and then Get Configuration from Device or Get Section from Device.
7. Select REG # and add information into the displays as shown in [Figure 5-2](#).

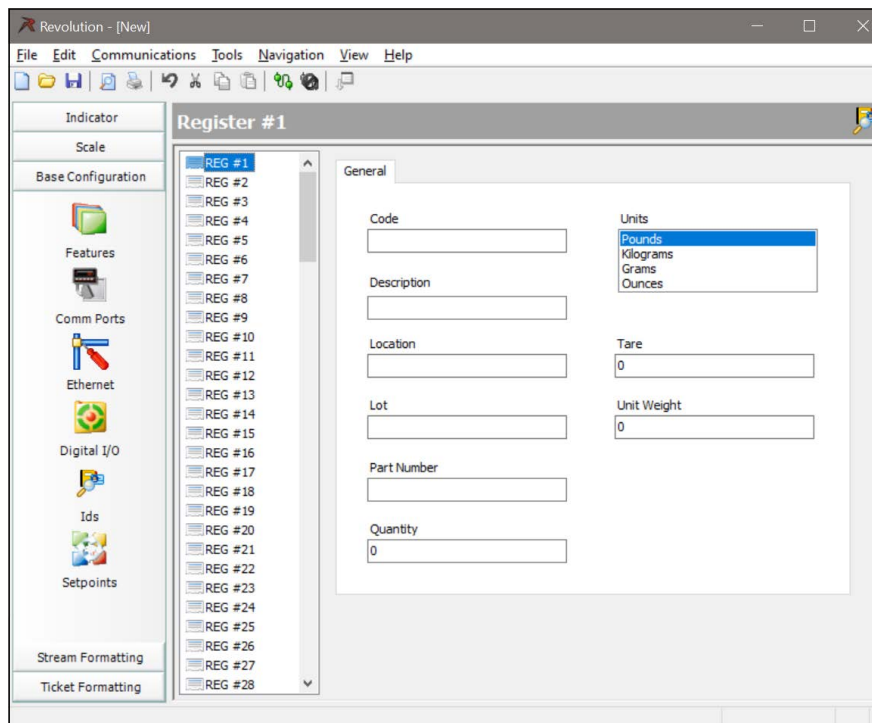

Figure 5-2. Adding IDs Through Revolution

8. To download the ID to Counterpart, connect Revolution, and select **Communications** and either Send Configuration to Device or Send Section to Device.
9. All register IDs are now entered and available through Revolution.



NOTE: By uploading IDs using Revolution and saving them to a file the IDs can be backed up for future use.

5.7 WeighVault

WeighVault is a PC program that allows Counterpart users to add, edit, and access IDs over a network connection. WeighVault surpasses the Counterpart's 150 ID limitation and eliminates front-panel entry of ID parameters. In and Out softkeys can be used to update the ID quantity with inventory changes. Setting up softkeys is explained in [Section 1.9 on page 10](#). If WeighVault is enabled the inventory changes are also sent to the WeighVault PC.

It also collects data as transactions occur, and provides detailed transaction and productivity reports that can be exported to Excel, Word, or PDF. For WeighVault to function, the following criteria must be met:

- Use onboard Ethernet or wireless option. See the Ethernet TCP/IP Interface Installation and Configuration Manual (PN 72117)
- IP address assigned to the Counterpart. See the Ethernet TCP/IP Interface Installation and Configuration Manual (PN 72117)
- WeighVault enabled in the Counterpart menu (ETHERNET menu ([Section 3.7.3 on page 45](#))). [Table 5-1](#) lists parameters that must be entered in order for WeighVault to work.

Parameter	Default
DHCP	Consult with network administrator
IP ADDRESS	Consult with network administrator
NET MASK	Consult with network administrator
PORT	Port 10001
REMOTE IP	IP address of computer running WeighVault — must be static
REMOTE PT	5466
VAULT	CONBOARD, or EXTERNAL if using a wireless option

Table 5-1. WeighVault Default Settings



NOTE: These default settings apply only if the VAULT parameter is set to ONBOARD ([Figure 3-21 on page 54](#)).

5.7.1 Demo Setup of Counterpart and WeighVault

Install WeighVault. There are two setup programs that need to be installed.

On the PC

This setup was completed in Windows 7, however the basic information about setup is applicable to other computer operating systems.

Use the following steps to set up WeighVault on the computer side.

1. Plug in crossover cable. The computer should be able to identify this cable.
2. Go to Properties, Internet Protocol, Version 4 - TCP/IPv4.
3. Choose Assign IP address.
4. Use the following IP address for this demo: 192.168.0.02 (Check with the site specific network administrator when setting a system.)
5. Click on subnet mask field. This will fill in the display automatically.
6. Click OK and close each window.

On the Counterpart

Use the following steps to set up WeighVault on the Counterpart side.

1. Enter menu settings and go to Ethernet.
2. DHCP should be set to Off.
3. Set the IP address 192.168.0.02 (this should be in the same range as the computer side, but the last digit is different. (Check with the site specific network administrator when setting a system.)
4. Set the subnet mask — 255.255.255.0.
5. Set the default gateway, DNS Pri, DNS Sec — no changes.
6. Set the local port — 10001.
7. Set the remote IP address — 192.168.0.02 (this is set same as computer above).
8. Set the remote port — 5466.
9. Set the Vault — set onboard.
10. Set up softkey — Code.
11. IN/OUT softkey — for in/out inventory setup

5.7.2 Using WeighVault

Once the above criteria have been met, IDs can be entered into WeighVault and saved on the PC's hard drive. The Edit Product dialog box in Figure 5-3 shows ID parameters that can be saved in WeighVault.

For testing purposes, enter a few part numbers and click **Save Changes to Database**.

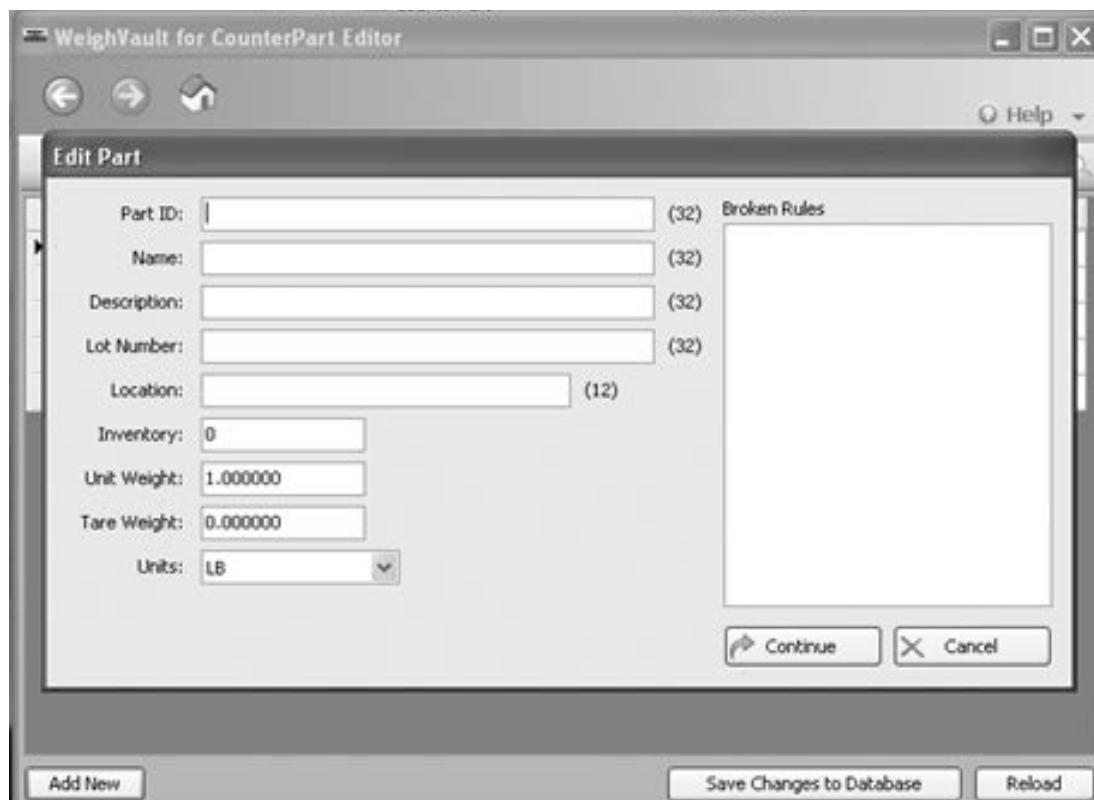



Figure 5-3. WeighVault Edit Product Dialog Box

To access a saved ID from WeighVault over the network connection,

1. Using the Counterpart front panel, press the **CODE** key.
2. Enter an **ID CODE** value.
3. Press . The ID CODE is loaded and ready to use.

 **NOTE:** If the demo feature is complete and not being used permanently with WeighVault, go to network settings and turn off the Assign IP Address feature.

5.8 Totalization

Counterpart has a totalization function that allows for totaling the quantity of several weighings together. The totalization function is especially helpful if putting together parts kits. The ID code is functional with totalization, count or weight.

For full operation of the totalization feature, configure the unit with the following softkeys:

- Total+**
- Total-**
- Clear Total**

Totalization finds the total accumulated quantity of parts in multiple similar containers.

An example using six containers is detailed below; all containers are of the same empty weight.

1. Conduct a sampling process to determine the unit weight of the pieces, or key in or scan a known unit weight or recall an ID.
2. Enter a known tare weight or place an empty container on the scale to perform tare function. If an ID was recalled in [Step 1](#), its tare value is already loaded.

3. Place container 1 (full of parts) on the scale. The number of pieces in the container is shown in the **PCS** area of the display.
4. Press the **Total+** softkey to store the number of pieces in container 1. The memory (**M**) icon is shown. The net weight of the items in the containers is stored and the totalization count is incremented. The piece count value displays. The total count is shown in place of the unit weight display, and it is labeled as Total Weight **ttl**.
5. Remove container 1 and place container 2 (full of parts) on the scale.
6. Press the **Total+** softkey. The accumulated total is now equal to container 1 plus container 2. The displayed total is also updated.
7. Continue with the remainder of the containers in the same totalization method. The total number of parts stored in all six containers (and the weight of the parts in those containers) is now stored and shown on the display.



NOTE: An ID may be loaded while part totalization is being performed, the ID Quantity value is not affected by the totalization operations.

If a totalization has been started and the Code softkey is pressed — the unit will prompt Exit Totalization Mode? with Yes and No softkeys. Pressing Yes clears the total, exits from totalization mode and brings up the normal prompt for entering an ID code. If No is pressed, the unit does not prompt for an ID Code and totalization can continue.

The user cannot switch to another scale during totalization. If the Scale Select softkey is pressed during totalization, the message not allowed — totalizing will be displayed and the switch will not occur.

The user cannot switch units during totalization. If the Unit Toggle key is pressed during totalization, the message not allowed - totalizing will be displayed and the switch will not occur.

During totalization an icon displays between the battery icon and the main display area label. The icon is an uppercase M for memory.

For each totalization done (Total+ or Total-) a count will be incremented. This value can be printed. When the total piece value is cleared, the count will be cleared as well.

While in totalization mode, pressing  prints the total format — TOTALFMT.

When attempting a totalization, a motion check can be performed based upon the setting of the TOTAL parameter in the Feature menu. If Total is ON and if there is motion, then one more attempt will be made after two seconds. The default setting is OFF.

To clear the total value and exit totalization mode, press the Clear Total softkey.

5.8.1 Parts Reduction Counts

Parts reduction is the removal and totalization of parts from a container. See the following information for an example of parts reduction:

1. Conduct a sampling process to determine the unit weight of the pieces, or key in or scan a known unit weight or recall an ID.
2. Enter known tare weight, or place an empty container on the scale to perform tare function. If ID was recalled in [Step 1](#), its tare value is already loaded.
3. Place the container (full of parts) on the scale. The number of pieces in the container is shown in the **PCS** area of the display.
4. Press the **Total+** softkey to store the number of pieces in the container. The memory (**M**) icon is shown. The net weight of the items in the container is stored and the totalization count is incremented. The total piece count value is shown in place of the piece weight value and will be labeled **ttl**. The total net weight is shown in place of the normal ID Code: line - it is labeled as Total Weight.
5. Remove the number of parts required from the container and press the **Total-** softkey. The total piece count value is now equal to the number of pieces removed. The number of pieces remaining in the container is shown in the **PCS** area of the display. The total weight is now equal to the weight of the removed pieces.
6. Repeat [Step 5](#) as needed.



NOTE: Once part reduction has been started, pressing Total+ results in the error message: Error - Reduction.

5.9 Accumulate Feature For Weight



The accumulate feature allows a weight value to be accumulated. See the following information to use this feature:

1. Enable the accumulate feature in the Scale Menu.
2. Set up the **Display Accum — (DSPACC)** and **Swap Display (SWAPDSP)** softkey. For softkey setup, see [Section 1.9.1 on page 11](#).
3. Weight must be active on the display, press Swap Display softkey as needed to display the weight in the main area.
4. Each time there is a print, the weight value is added to the accum register and keeps track of how many accums were completed. Product must be removed from the platform and the display returned to zero each time this is done.

5.9.1 Printing the Accumulated Total

Press  to print the accumulated total when the Accum Value displays.

5.9.2 Clearing the Accumulated Total

1. Press  when the Display Accum softkey has been pressed.
2. **PRESS CLEAR TO VERIFY** displays. Press  to clear the accum value.

5.10 Inventory Adjustment

Use the following steps to update the inventory count using the IN and OUT softkeys.

1. Press IN to add the displayed piece count value to the quantity on hand of a stored ID code.
2. Press OUT to remove the displayed piece count value from the quantity on hand of a stored ID code.

If an ID is not loaded or the Single ID feature is enabled, pressing either the IN or OUT softkey results in the error message: No ID Loaded, and no inventory adjustment is mode.

5.11 Batch Operations

Softkeys can be configured to allow the operator control of batch operations from the Counterpart front panel ([Figure 5-4](#)). Softkeys can be configured using serial commands, or the FEATURE menu.



Figure 5-4. Counterpart Batch Operation Screenshot

Parameter	Description
Setpoint	Display or change assigned setpoints
Batch Start	Starts the batch process
Batch Reset	Stops and resets an active batch to the beginning of the process
Batch Stop	Stops an active batch and turns off all associated digital outputs

Table 5-2. Batching Softkeys

Batching Switch

The batching switch option, PN 19369, comes as a complete unit in an FRP enclosure, with legend plate, locking stop switch (mushroom button), and a run/start/abort 3-way switch.

Both switches are wired into the Counterpart's digital I/O terminal strip as shown in [Figure 5-6 on page 72](#). Each switch uses a separate digital input.

Once cables and switch have been connected to Counterpart, use the menu button to place Counterpart in Setup mode.

Use the DIG I/O menu to configure the digital input and output functions.

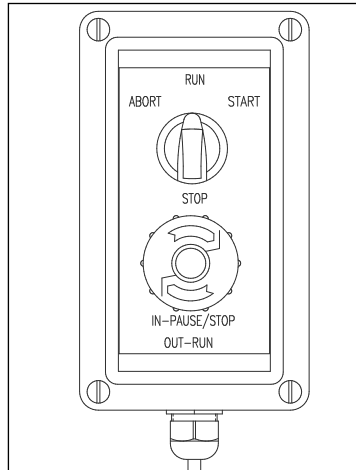

Figure 5-5. Batching Switch

When configuration is complete, exit setup mode. Initialize the batch by turning the 3-way switch to Abort, then unlock the STOP button (the STOP button must be in the OUT position to allow the batch process to run). The batching switch is now ready to use.



WARNING: If no digital input is assigned to BATRUN, batching proceeds as if BATRUN were always on; the batch will start the 3-way switch is turned to RUN, but the STOP mushroom button will not function

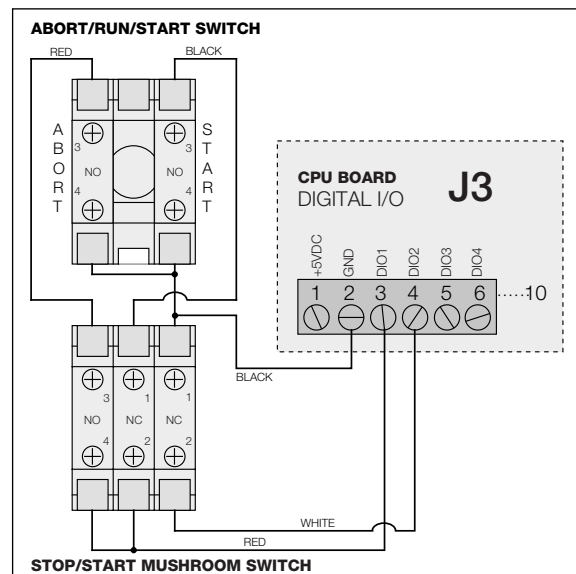

Figure 5-6. Batching Switch Wiring Diagram Example

To begin a batch process, turn the 3-way switch to START momentarily. If the STOP button is pushed during the batch process, the process halts and the button locks in the IN position.

The START switch is ignored while the STOP button is locked in the IN position. The STOP button must be turned counterclockwise to unlock it, then released into the OUT position to enable the 3-way switch.

To restart an interrupted batch from the step where it left off, do the following:

1. Unlock the STOP button (out position).
2. Turn the 3-way switch to START.

To restart an interrupted batch from the first batch step, do the following:

1. Turn 3-way switch to ABORT.
2. Unlock STOP button (out position).
3. Turn the 3-way switch to START.



NOTE: Use this procedure (or the **BATRESET** serial command) to initialize the new batch routine following any change to the setpoint configuration.

5.12 Connecting a Barcode Scanner

The Counterpart will accept a barcode scanner connected to the unit. In order to use a scanner, the specifications of the Counterpart scale must be set to recognize the scanner to the appropriate port and, in some cases, do the setup on the scanner required by the scanner manufacturer.

The scanner allows non-contact, instantaneous, and accurate input of unit weight, tare weight, and ID code.

QD2100 Barcode Scanner

If using the Quicksan QD2100 barcode scanner sold by Rice Lake Weighing Systems, the scanner can be set up by connecting the scanner (PN 121495) to the RS-232 port on the Counterpart CPU board. Plug connector with three wires into serial port 2 (J4) and plug with one wire into DIGIO (J3). Connections between the barcode scanner and Counterpart should be wired as shown in [Table 5-3](#).

Pin out	Wire Color
RX	Green
TX	Red
Ground	Black
DIGIO	
5+	

Table 5-3. Barcode Wiring Connections

The default baud rate is set for 9600 for both Counterpart and the scanner.

To set up barcode scanner parameters:

1. Navigate through the menu Setup >> Config >> Serial.
2. Set up the selected Port, J5 (Port 1) or J4 (Port 2) for the scanner.
3. Follow through and set up the various parameters such as 9600 baud, 8 bits, 1 stop bit, none parity.
4. If using barcodes with embedded headers ([Table 5-4](#)), set the Headers parameter to **ON**.
5. If the Headers parameter is set to **OFF**, the Counterpart assumes that all scanned items are ID codes.

Header Code	Description	Action
1	Unit Weight	Scanned unit weight value updates the working ID and is also applied
3	ID Code	Scanned ID code is loaded
4	Tare	Scanned tare value updates the working ID and is also applied to the scale
L	Lot Number	Scanned lot number updates the working ID and a Yes/No prompt is shown asking if stored ID should also be updated
M	Part Number	Scanned part number updates the working ID and a Yes/No prompt is shown asking if stored ID should also be updated

NOTE: PN 121495 is supplied with 2 connectors. Plug connector with 3 wires into J4. Plug connector with 1 wire into J3.

Table 5-4. Header Codes for Barcodes

6.0 EDP Commands

The Counterpart can be controlled by a PC or remote keyboard connected to an indicator communications port. Control is provided by a set of EDP commands that can simulate front panel key press functions, display and change setup parameters, and perform reporting functions. This provides the ability to print configuration data or to save to the hard drive.

6.1 Command Set

The command set can be divided into five groups: key press commands, reporting commands, the RESETCONFIGURATION special function command, parameter setting commands, and transmit weight data commands. When a command is processed, the Counterpart responds with the message **OK**. The **OK** response verifies that the command was received and has been executed. If the command is unrecognized or cannot be executed, the Counterpart responds with **??**.

The following sections list the commands and command syntax used for each of these groups.

6.1.1 Key Press Commands

Key press commands simulate pressing the keys on the front panel of the indicator. These commands can be used in both setup and normal (weighing) mode. Several of the commands serve as “pseudo” keys, providing functions that are not represented by a key on the front panel.

For example, to enter a 15 lb tare weight:

1. Type K1 and press **ENTER** (or **RETURN**).
2. Type K5 and press **ENTER** (or **RETURN**).
3. Type KTARE and press **ENTER** (or **RETURN**).

Command	Description
KMENU	Press the MENU key
KZERO	In weighing mode, press the ZERO key
KUNITS	In weighing mode, press the UNITS key
KPRINT	In weighing mode, press the PRINT key
KSAMPLE	In weighing mode, press the SAMPLE key
KTARE	Press the TARE key
KID	In weighing mode, press the Code softkey
KGROSSNET	In weighing mode, press the GROSS/NET key
KGROSS	Go to gross mode (pseudo key)
KNET	Go to net mode (pseudo key)
KDISPACCUM	Display ACCUM (pseudo key)
KDISPTARE	Display tare (pseudo key)
KCLR	Press the CLEAR key
KCLRRCN	Reset consecutive number (pseudo key)
KCLRTR	Clear tare from system (pseudo key)
KLEFT	In menu mode, move left in the menu
KRIGHT	In menu mode, move right in the menu
KUP	In menu mode, move up in the menu; In data entry mode, increment the current digit
KDOWN	In menu mode, move down in the menu; In data entry mode, decrement the current digit
KSAVE	In menu mode, saves the current configuration
KEXIT	In menu mode, saves the current configuration then exits to normal mode
K0–K9	Press number 0 (zero) through 9
KDOT	Press the decimal point (.) key
KENTER	Press the ENTER key
KLOCK	Lock specified front panel key; For example, to lock the ZERO key, enter KLOCK = KZERO
KUNLOCK	Unlock specified front panel key; For example, to unlock the PRINT key, enter KUNLOCK = KPRINT
KDATE	Display the time and date (pseudo key)
KTIME	Display the time and date (pseudo key)
KESCAPE	In weigh mode, exits from a prompt; In setup mode, functions identical to the MENU key in menu mode: <ul style="list-style-type: none"> • If a parameter is selected, exits the parameter without saving any changes • Returns to weigh mode if a parameter is not selected
KSOFTx	Press softkey number x
KBASE	Allows user to cycle through the scales in a multi-scale unit

Table 6-1. Key Press Commands

6.1.2 ID Commands

Up to 150 codes can be entered under ID commands.

Command	Description
ID.CODE# <i>n</i>	ID code
ID.DESC# <i>n</i>	Item description
ID.LOCATION# <i>n</i>	Item stock location
ID.LOT# <i>n</i>	Lot number
ID.PARTNUMBER# <i>n</i>	Part number
ID.QUANTITY# <i>n</i>	Inventory quantity
ID.TARE# <i>n</i>	Tare weight value
ID.UNITS# <i>n</i>	Units for tare and unit weight values
ID.UNITWEIGHT# <i>n</i>	Unit weight value
ID.CLRALL	Clear all IDs from memory NOTE: The ID.CLRALL command only works in setup mode.
ID.CLEAR.INDEX# <i>n</i>	Clear ID at index <i>n</i> from memory
ID.CLEAR.CODE# <i>n</i>	Clear ID with code of <i>n</i> from memory

Table 6-2. ID Commands

6.1.3 Reporting Commands

Reporting commands send specific information to the communications port. The commands listed in [Table 6-3](#) can be used in all modes.

Command	Description
DUMPALL	List all parameter values, ID information and setpoint data
DUMPCONFIG	List all parameter values excluding ID information and setpoint data
DUMPAUDIT	List audit trail information
DUMPBUFFER	Lists Weighvault buffer information
DUMPIDS	List all ID information
DUMPID.INDEX	List a specific ID by index (Section 6.1.7 on page 80)
DUMPID.CODE	List a specific ID by code (Section 6.1.7 on page 80)
VERSION	Write Counterpart software version
P	Write current displayed weight with units identifier (Section 9.2.1 on page 93)
XE	Returns a 10-digit code representing any error conditions currently shown on the front panel
ADCS	Return number of A/Ds installed

Table 6-3. Reporting Commands

6.1.4 Clear and Reset Commands

The following commands can be used to clear and reset the Counterpart:

Command	Description
RS	Reset system; Reboots the indicator without resetting the configuration
RESETCONFIGURATION	Restores all configuration parameters to their default values (menu mode only); The RESETCONFIGURATION function can also be initiated by navigating to the DEFAULT parameter under the VERS menu and selecting YES; Then press ENTER to reset the indicator; All load cell calibration settings are lost when the RESETCONFIGURATION command is run
CLEARBUFFER	Clears the Weighvault data buffer.

Table 6-4. Reporting Commands

6.1.5 Parameter Setting Commands

Parameter setting commands display or change the current value for a particular configuration parameter.

Current configuration parameter settings can be displayed in all modes using the following syntax: **command<ENTER>**

Most parameter values can be changed in menu mode only.

Use the following command syntax when changing parameter values: **command=value<ENTER>**, where **value** is either a number or a parameter value. Use no spaces before or after the equal (=) sign. If an incorrect command is typed, the display reads ??.

For example, to set the motion band parameter to 5 divisions, type the following:

SC.MOTBAND=5<ENTER>

For parameters with selectable values, enter the command and equal sign followed by a question mark: **command=?<ENTER>** to see a list of those values. The indicator must be in menu mode to use this function.



NOTE: Some parameters are valid only if other parameters or parameter values are specified. Restrictions for front-panel configuration also apply to EDP command configuration.

Command	Description	Values
SC.GRADS# <i>n</i>	Graduations	1–100000
SC.ZTRKBD# <i>n</i>	Zero track band	0, 0–100
SC.ZRANGE# <i>n</i>	Zero range	1.900000, 0–100
SC.MOTBAND# <i>n</i>	Motion band	1, 0–100
SC.SSTIME# <i>n</i>	Standstill time	1–65535
SC.OVRLOAD# <i>n</i>	Overload	FS+2%, FS+1D, FS+9D, FS
SC.DIGFLTR1# <i>n</i> SC.DIGFLTR2# <i>n</i> SC.DIGFLTR3# <i>n</i>	Digital filtering	1, 2, 4, 8, 16, 32, 64, 128, 256
SC.DFSSENS# <i>n</i>	Digital filter cutout sensitivity	2OUT, 4OUT, 8OUT, 16OUT, 32OUT, 64OUT, 128OUT
SC.DFTHR# <i>n</i>	Digital filter cutout threshold	NONE, 2D, 5D, 10D, 20D, 50D, 100D, 200D, 250D
SC.THRESH# <i>n</i>	Zero threshold	0–9999999
SC.SMPRAT# <i>n</i>	Sample rate	30HZ, 60HZ, 120HZ, 240HZ, 480HZ, 960HZ
SC.PWRUPMD# <i>n</i>	Power up mode	GO, DELAY
SC.TAREFN# <i>n</i>	Tare function	BOTH, NOTARE, PBTARE, KEYED
SC.PRI.DPCPNT# <i>n</i>	Primary units decimal position	8.888888, 88.888888, 888.888888, 8888.888888, 88888.888888, 888888.888888, 8888888.888888, 88888880, 88888800
SC.PRI.DSPDIV# <i>n</i>	Primary units display divisions	1D, 2D, 5D
SC.PRI.UNITS# <i>n</i>	Primary units	lb, kg, g, oz, OFF
SC.ACCUM# <i>n</i>	Accumulator enable	ON, OFF
SC.WZERO# <i>n</i>	Zero calibration	
SC.WVAL# <i>n</i>	Test weight value	0.000001-9999999.0, 10000.0 (default)
SC.WSPAN# <i>n</i>	Span calibration	

Table 6-5. Scale Commands

Command	Description	Values
SC.WLIN.F1– SC.WLIN.F5#n	Actual raw count value for linearization points 1–5	0–16777215
SC.WLIN.V1 SC.WLIN.V5#n	Test weight value for linearization points 1–5	0.000001–9999999
SC.WLIN.C1– SC.WLIN.C5#n	Calibrate linearization points 1–5	
SC.LC.CD#n	Deadload coefficient	
SC.LC.CW#n	Span coefficient	
SC.LC.CZ#n	Temporary zero	
SC.REZERO#n	Rezero	
SC.SEC#n	Secondary units	lb, kg, g, oz, OFF
SC.TER#n	Tertiary units	lb, kg, g, oz, OFF
SC.N	In weigh mode, returns the active scale number. Returns ?? if used in config mode.	

Table 6-5. Scale Commands (Continued)

Command	Description	Values	
EDP.BAUD#p	Port baud rate	1200, 2400, 4800, 9600, 19200, 28800, 38400, 57600, 115200	
EDP.BITS#p	Port data bits/parity	8NONE, 7EVEN, 7ODD	
EDP.STOPBITS#p	Port stop bits	1, 2	
EDP.PRMSG#p	Print message	ON, OFF	
EDP.ECHO#p	Port echo	ON, OFF	
EDP.EOLDLY#p	Port end-of-line delay	0–255 (0.1-second intervals)	
EDP.HEADERS#p	Port header	ON, OFF	
EDP.INPUT#p	Port input	PORT 1 - CMD, SCANNER, SCALE, IND SC PORT 2 - CMD, SCANNER PORT 3 - CMD, SCANNER, KEYBOARD	
EDP.PORT	Port reporting command; It responds with the number of the port that the user is connected to		
EDP.RESPONSE#p	Port response	ON, OFF	
EDP.SOURCE#p	Port source	1, 2, 3	
EDP.STREAM#p	Port stream	OFF, LFT, INDUST	
EDP.TERMIN#p	Port termination	CR/LF, CR	
STR.POS#p	Custom stream identifiers	None, Space, +	
STR.NEG#p		None, Space, -	
STR.PRI#p		8 alphanumeric characters	
STR.SEC#p			
STR.TER#p			
STR.GROSS#p			
STR.NET#p			
STR.TARE#p			
STR.MOTION#p			2 alphanumeric characters
STR.RANGE#p			
STR.OK#p			
STR.INVALID#p			
STR.ZERO#p			
OPTCARD		Option cards	NONE, FIBER, ETHERNET, WI-PORT, RESERVED, USB, RS232-422, KEYBOARD

Table 6-6. Serial Port Commands

Command	Description	Values
CFGPWD	Configuration password	0, 1-9999999
CONSNUM	Consecutive numbering	0-9999999
CONSTUP	Consecutive number start-up value	0-9999999
DATEFMT	Date format	MMDDYYYY, DDMMYYYY, YYYYMMDD, YYYYDDMM
DATESEP	Date separator	SLASH, DASH, SEMI
DECFMT	Decimal format	DOT, COMMA
DSPBRIGHT	Sets display intensity	0 (dimkest), through 100 (brightest) as a percentage
KYBDLK	Keyboard lock (disable keypad)	OFF, ON
REG.AGENCY	Audit agency (Industrial mode)	NONE, OIML, NTEP, CANADA, INDUST
REGULA	Regulatory compliance	NONE, OIML, NTEP, CANADA, INDUST
REG.CTARE	Allow clear keyed tare	NO, YES
REG.WORD	Weighing mode	Gross, Brutto
REG.KTARE	Always allow keyed tare	NO, YES
REG.MTARE	Multiple tare action	REPLACE, REMOVE, NOTHING
REG.NTARE	Allow negative tare	NO, YES
REG.ZTARE	Remove tare on ZERO	NO, YES
REG.BASE	Zero base for overload calculation	CALIB, SCALE
REG.PRTMOT	Allow print while in motion	NO, YES
REG.PRINTPT	Add PT to keyed tare print	NO, YES
REG.SNPSHOT	Display or Scale weight source	DISPLAY, SCALE
TIMEFMT	Time format	12HOUR, 24HOUR
TIMESEP	Time separator	COLON, COMMA
SK#1 - SK#12	Softkey Assignment	BLANK, TIMEDATE, CLRTAR, DSPTAR, DSPACC, SCLSEL, CODE, LOT, PRINTLOT, SWAPDSP, IN, OUT, CLRCN, TOTAL+, TOTAL-, CLRRTL, UWUPDT, TAREUPDT, SETPT, BATSTRT, BATSTOP, BATPAUSE, BATRST
SINGLEID	Single ID Mode	OFF, ON

Table 6-7. Feature Commands

Command	Description	Values
DISPACC	Display Accuracy enable/disable	ON, OFF
INSFSMPL	Insufficient Sample percentage	0.1%, 0.2%, 0.0%
NEGCOUNT	Negative Counting enable/disable	ON, OFF
XFRSMPL	After Sample scale switch	ON, OFF
UNITWTUPDATE	Unit Weight Update enable/disable	ON, OFF
REZERO	Auto zero when changing scales	ON, OFF
UNITWTBASE	Unit Weight Base selection	1000, 1
CHECKSTABILITY	Check for Stability when changing scales	ON, OFF
SAMPLQTY	The default value for Sample Quantity	10, 25, 50, 100
TRANSFERUNITWEIGHT	Transfer Unit Weight when changing scales	ON, OFF
NEWITEM	New Item enable/disable	ON, OFF
LOTUPDT	Lot Update enable/disable	ON, OFF
DSPMODE	Display Mode selection	COUNT, WEIGHT, UNITWEIGHT
TRANSFERTARE	transfer Tare when changing scales	ON, OFF
REMOVTSP	Remove trailing spaces from ID Code	ON, OFF

Table 6-8. Count Commands

Command	Description	Values
GFMT.FMT	Gross print format string	See Section 7.0 on page 81 for information about demand print format strings
NFMT.FMT	Net print format string	
ACC.FMT	Accumulator print format string	
CFMT.FMT	Count print format string	
TOTAL.FMT	Total print format string	
SPFMT.FMT	Setpoint print format string	
HDRFMT1	Header 1 print format string	
PALFMT.FMT	Pallet print format string	
HDRFMT2	Header 2 print format string	

Table 6-9. PFORMT Commands

Command	Description	Values
DIO#b	Digital I/O function	OFF, ZERO, NT/GRS, TARE, UNITS, PRINT, CLEAR, CLRCN, GROSS, DSPACC, SAMPLE, SFTKEY 1, SFTKEY 2, SFTKEY 3, SFTKEY 4, OUTPUT
Digital inputs and outputs are specified by bit number		

Table 6-10. DIG I/O Commands

Command	Description	Values
GFMT.PORT	Set the transmit port for each of these formats	PORT 1
NFMT.PORT		PORT 2
ACC.PORT		PORT 3
CFMT.PORT		
TOTAL.PORT		
PALFMT.PORT		
SPFMT.PORT		

Table 6-11. Print Format Port Commands

Command	Description	Values
KEYLCK.NUMBER	Keys can be locked or unlocked;	LOCK
KEYLCK.PRINT	Default for all: Unlock	UNLOCK
KEYLCK.TARE		
KEYLCK.ZERO		
KEYLCK.SAMPLE		
KEYLCK.GROSSNET		
KEYLCK.UNITWT		

Table 6-12. Keylock Commands

Command	Description	Values
ETH.DEFAULTGATEWAY	Sets IP address	0.0.0.0
ETH.DHCP	DHCP	ON, OFF
ETH.DNSPRIMARY	DNS Primary	0.0.0.0
ETH.DNSSECONDARY	DNS Secondary	0.0.0.0
ETH.IPADDRESS	IP Address	192.168.0.1
ETH.LOCALHOSTNAME	Local Host Name	COUNTERPART
ETH.MACADDRESS	Mac Address	00-00-00-00-00-00
ETH.NETMASK	Netmask	0.0.0.0
ETH.PORT	Port	10001
ETH.REMOTESERVERIP	Remote server IP	0.0.0.0
ETH.REMOTESERVERPORT	Remote server port	5466
ETH.WEIGHVAULT	WeighVault	OFF, ONBOARD, EXTERNAL
ETH.ECHO	Echo EDP commands	ON, OFF

Table 6-13. Ethernet Commands

6.1.6 Normal Mode Commands

The normal mode print commands transmit data to the communications port on demand in either setup or normal mode.

Command	Description	Values
CONSUM# <i>n</i>	Set consecutive number	nnnnnnn
UID	Set unit ID	UID=nnnnnnn
SX# <i>n</i>	Start communications port streaming	OK or ??;
EX# <i>n</i>	Stop communications port streaming	An EX command sent while in menu mode does not take effect until the indicator is returned to normal mode; The EDP Stream parameter must be set to LFT or INDUST for this command to work
XG# <i>n</i>	Transmit gross weight in displayed units	nnnnnn UU
XN# <i>n</i>	Transmit net weight in displayed units	where nnnnnn is the weight value, UU is the units
XT# <i>n</i>	Transmit tare weight in displayed units	NOTE: You can also send XGP, XGS, XGT, XTP, etc. to specify primary, secondary or tertiary (P.S.T.).
XA# <i>n</i>	Transmit accumulator value	
RS	Reset system	Soft reset; Used to reset the indicator without resetting the configuration to the factory defaults
SD	Set date	SD=MMDDYY, DDMMYY, YYYYMMDD, or YYDDMM ; Enter six-digit date using year-month-day order specified for the DATEFMT parameter, using only the last two digits of the year
ST	Set time	ST=hhmm (enter using 24-hour format)
KSOFT1-4	Command to perform function assigned to softkey	–
PIECES# <i>n</i>	Transmits the current piece count on scale number <i>n</i>	Sending the command without the scale number, e.g. "PIECES", returns the piece count from the active scale

Table 6-14. Normal Mode Commands

6.1.7 Unique Commands

Command	Description
DUMPID.INDEX= <i>n</i>	To dump an ID by register
DUMPID.CODE= <i>n</i>	To dump an ID by code
KDISPMODE	Set or request the current display mode; This only temporarily switches the display, remains in effect until a power cycle or the menu is entered and exited; The power up display mode is set by the DISPMODE parameter The choices are: COUNT WEIGHT UNITWEIGHT <i>Example: KDISPMODE=COUNT</i> Will switch the display to show the piece count in the large display area

Table 6-15. Unique Commands

7.0 Print Formatting

The Counterpart provides nine print formats, GFMT, NFMT, TOTALFMT, PALFMT, CFMT, ACCFMT, SPFMT, HDRFMT1, and HDRFMT2. These determine the format of the printed output when  is pressed or when a KPRINT EDP command is received.

The HDRFMTs must be called from another format. The SPFMT (setpoint print format) is printed from a setpoint routine.

Each print format can be customized to include up to 500 characters of information, two header formats are limited to 100 characters each), such as company names and addresses, on printed tickets. The indicator front panel (PFORMT menu), EDP commands, or the Revolution configuration utility can be used to customize the print formats.



NOTE: Print formats are limited to 500 characters. The two header formats are limited to 100 characters each.

7.1 Print Formatting Tokens

Table 7-1 lists tokens which can be used to format the gross, net and count print formats. Tokens included in the format strings must be enclosed between < and > delimiters. Any characters outside of the delimiters are printed as text on the ticket.

Token	Description	Supported Ticket Formats
<G>	Gross weight, current scale	GFMT, NFMT, TOTALFMT, PALFMT, CFMT, ACCFMT, HDRFMT1, HDRFMT2
<G#n>	Gross weight, scale <i>n</i>	
<N>	Net weight current scale	
<N#n>	Net weight, scale <i>n</i>	
<T>	Tare weight in displayed units; Add four before bracket to print header	
<T#n>	Tare weight, scale <i>n</i>	
<A>	Accumulated weight, current scale	
<A#n>	Accumulated weight, scale <i>n</i>	
<AC>	Number of accumulations, current scale (5-digit counter)	
<AC#n>	Number of accumulations, scale <i>n</i>	
<AD>	Date of last accumulation, current scale	
<AD#n>	Date of last accumulation, scale <i>n</i>	
<AT>	Time of last accumulation, current scale	
<AT#n>	Time of last accumulation, scale <i>n</i>	
<UID>	Unit ID number	
<CN>	Consecutive number	
<C>	Piece count, current scale	
<C#n>	Piece count, scale <i>n</i>	
<NLnn>	New line (nn = number of termination (<CR/LF> or <CR>) characters)*	
<SPnn>	Space (nn = number of spaces)*	
<SU> or <WA>	Suppress units. Toggle weight data format (formatted/unformatted)**	
<TI>	Time	
<nnn>	ASCII character (nnn=decimal value of ASCII character); Used for inserting control characters (STX, for example) in the print stream	
<DA>	Date	
<TD>	Time & Date	
<H1>	Header 1	
<H2>	Header 2	
<IDC>	Loaded ID Code - 32 characters maximum	
<IDD>	Loaded ID Description - 32 characters maximum	
<IDL>	Loaded ID Location - 12 characters maximum	
<IDP>	Loaded ID Part Number - 32 characters maximum	
<IDLT>	Loaded ID Lot - 32 characters maximum	

Table 7-1. Print Format Token

Token	Description	Supported Ticket Formats
<IDU>	Loaded ID Units - 1 character maximum	GFMT, NFMT, TOTALFMT, PALFMT, CFMT, ACCFMT, HDRFMT1, HDRFMT2
<IDT>	Loaded ID Tare - 9 characters maximum (range 0.0 to 9999999.0)	
<IDW>	Loaded ID Unit Weight - 9 characters maximum (range 0.0 to 9999999.0)	
<IDQ>	Loaded ID Quantity - 11 characters maximum (range -2000000000 to 2000000000)	
<TTLV>	Totalization Value - 11 character maximum (range -2000000000 to 2000000000); When not in totalization mode, the value will be 0	
<TTLC>	Totalization Count - 4 characters maximum; When not in totalization mode, the value will be 0	
<TTLW>	Print totalized weight; When not in totalization mode, the value will be 0	
<WA>	Suppresses all (units, decimal, leading, spaces)	
<WLU>	Without leading spaces and units, decimal point is still applied	
<WU>	Suppresses units but leaves leading spaces and decimal point	
<WL>	Suppress units; Toggle weight data format (formatted/unformatted)**	GFMT, NFMT, TOTALFMT, PALFMT, CFMT, ACCFMT, HDRFMT1, HDRFMT2
<SU> or <WA>	Suppress units and leading spaces	
<U>	Outputs K (kg) or L (lb) or O (oz).	SPFMT
<SCV>	Setpoint captured weight value	
<SN>	Setpoint weight number	
<STV>	Setpoint target weightvalue	
<SPV>	Setpoint preact weight value	
<SPM>	Setpoint weight mode	
<SCVC>	Setpoint captured count value	
<STVC>	Setpoint target count value	
<SPVC>	Setpoint preact count value	
Gross, net, and tare weights are 8 digits in length, including sign and decimal point, followed by a space and a one- to five-digit units identifier; Total field length with units identifier is 10-14 characters; Depending on what units are configured, the units identifier will be lb, oz, g, or kg		
Gross, net, tare, and accumulator weights can be printed in any configured weight units by adding the following modifiers to the gross, net, tare, and accumulator weight commands: /P (primary units), /D (displayed units), /S (secondary units), /T (tertiary units); If not specified, the current displayed units (/D) is assumed; Example: To format a ticket to show net weight in secondary units, use the following token: <N/S>		
UNIT ID and consecutive number (CN) fields are 1–6 characters in length, as required		
* If nn is not specified, 1 is assumed; Value must be in the range 1–99		
** After receiving an WA token, the indicator sends unformatted data until the next WA token is received; Unformatted data omits decimal points, leading and trailing characters		

Table 7-1. Print Format Token (Continued)

Format	Default Format String	Used When
NFMT	N<NL>A30,75,0,4,1,1,N,"Gross: <G>"<NL>B30,115,0,3,2,4,101,B,"<G>"<NL>A30,300,0,4,1,1,N, "Tare: <T>"<NL>B30,340,0,3,2,4,101,B,"<T>"<NL>A30,525,0,4,1,1,N, "Net: <N>"<NL>B30,565,0,3,2,4,101,B,"<N>"<NL>A30,806,0,3,1,1,N,"<TD>"<NL>P1<NL>	Normal mode, tare in system
PALFMT	N<NL>A416,25,1,4,1,1,N,"ID CODE: <IDC>"<NL>B378,25,1,3,2,4,51,N,"3<IDC>"<NL>A296,28,1,4,1,1,N,"Total QTY: <C>"<NL>B264,22,1,3,2,4,51,N,"<C>"<NL> A179,25,1,4,1,1,N,"Part Name: <IDD>"<NL>A126,25,1,4,1,1,N,"Part Number: <IDP>"<NL>A73,25,1,4,1,1,N,"Lot Number: <IDL>"<NL>P1<NL>	When Print Pallet softkey is pressed
CFMT	N<NL>B371,20,1,3,2,4,51,N,"3<IDC>"<NL>A410,20,1,4,1,1,N,"ID. CODE: <IDC>"<NL>A302,22,1,4,1,1,N,"QTY: <C>"<NL>B264,20,1,3,2,4,51,N,"<C>"<NL>A280,400,1,4,1,1,N,"GROSS <G>"<NL> A225,400,1,4,1,1,N,"TARE <T>"<NL>B189,355,1,3,2,4,51,N,"4<WLU><T>"<NL>A120,400,1,4,1,1,N,"NET <N>"<NL>A195,24,1,4,1,1,N,"WT/K OR U W" <NL>B124,20,1,3,2,4,51,N,"1<IDW>"<NL> A47,16,1,4,1,1,N,"<TD>"<NL>A160,24,1,4,1,1,N,"<IDW>"<NL>P1<NL>	Count mode
GFMT	N<NL>A376,47,1,4,4,3,N" <G>"<NL>B233,73,1,3,2,4,101,B" <G>"<NL>A73,77,1,4,1,1,N" <TD>"<NL> >P1<NL>	Normal mode, no tare in system
TOTAL	N<NL>A410,32,1,5,2,1,N,"<TOTAL QUAN- TITY>"<NL>A57,532,1,3,1,1,N,"<TD>"<NL>A309,39,1,5,2,1,N,"<TTLV>"<NL>B195,32,1,3,2,4,101,N ,"<TV>"<NL> A61,32,1,5,1,1,N,"BOX COUNT: <TTL>"<NL>P1<NL>	Totalization mode
SPFMT	N<NL>A274,53,1,2,3,3,N,"<IDD>"<NL>B421,55,1,3,1,2,96,B,"<IDC>"<NL>A96,49,1,1,4,4,N,"QTY<S CVC>"<NL>P1<NL>	Setpoint mode
ACCFMT	N<NL>A410,32,1,5,2,1,N,"TOTAL QUAN- TITY" <NL>A57,532,1,3,1,1,N,"<TD>" <NL>A309,39,1,5,2,1,N,"<A>" <NL>B195,32,1,3,2,4,101,N,"<A C>" <NL> A61,32,1,5,1,1,N,"ACCUMULATIONS: <AC>" <NL>P1<NL>	Accumulator enabled and displayed

Table 7-2. Default Print Formats

The default Counterpart print formats are shown in [Table 7-2](#) and [Table 7-3](#):

Format	Default Format String	Sample Output
H1	Company Name <NL> Street Address <NL> City, ST ZIP <NL2>	Company Name, Street Address, City, ST ZIP
H2	Company Name <NL> Street Address <NL> City, ST ZIP <NL2>	Company Name, Street Address, City, ST ZIP

Table 7-3. H1, H2 Formats

7.2 Customizing Print Formats

The following sections describe procedures for customizing the *GFMT*, *NFMT* and *CFMT* formats using the EDP port, the front panel (*PFORMT* menu), and the Revolution configuration utility.

7.2.1 Using the EDP Port

With a personal computer, terminal, the EDP command can be used to set to customize the print format strings.

To view the current setting of a format string, type the name of the string (*GFMT.FMT* or *NFMT.FMT*) and press .

For example, to check the current configuration of the *GFMT.FMT* format, type *GFMT.FMT* and press ENTER. The indicator responds by sending the current configuration for the gross format:

```
GFMT.FMT=<G> GROSS<NL>
```

To change the format, use the *GFMT.FMT* or *NFMT* EDP command followed by an equals sign (=) and the modified print format string. For example, to add the name and address of a company to the gross format, the following EDP command can be sent:

 **NOTE:** Indicator must be placed in the configuration mode with *CONFIG* shown on the display.

```
GFMT.FMT=FINE TRANSFER CO<NL>32400 WEST HIGHWAY ROAD<NL>SMALLTOWN<NL2><G> GROSS<NL>
```

A ticket printed using this format might look like the following:

```
FINE TRANSFER CO
32400 WEST HIGHWAY ROAD
SMALLTOWN
```

```
1345 lb GROSS
```

 **NOTE:** The 500-character limit of each print format string is the total of print formatting token characters and text, not the final output of the format.

7.2.2 Using the Front Panel

If access to equipment for communication through the EDP port is unavailable or such equipment cannot be used on site, the *PFORMT* menu ([Figure 7-1](#)) can be used to customize the print formats.

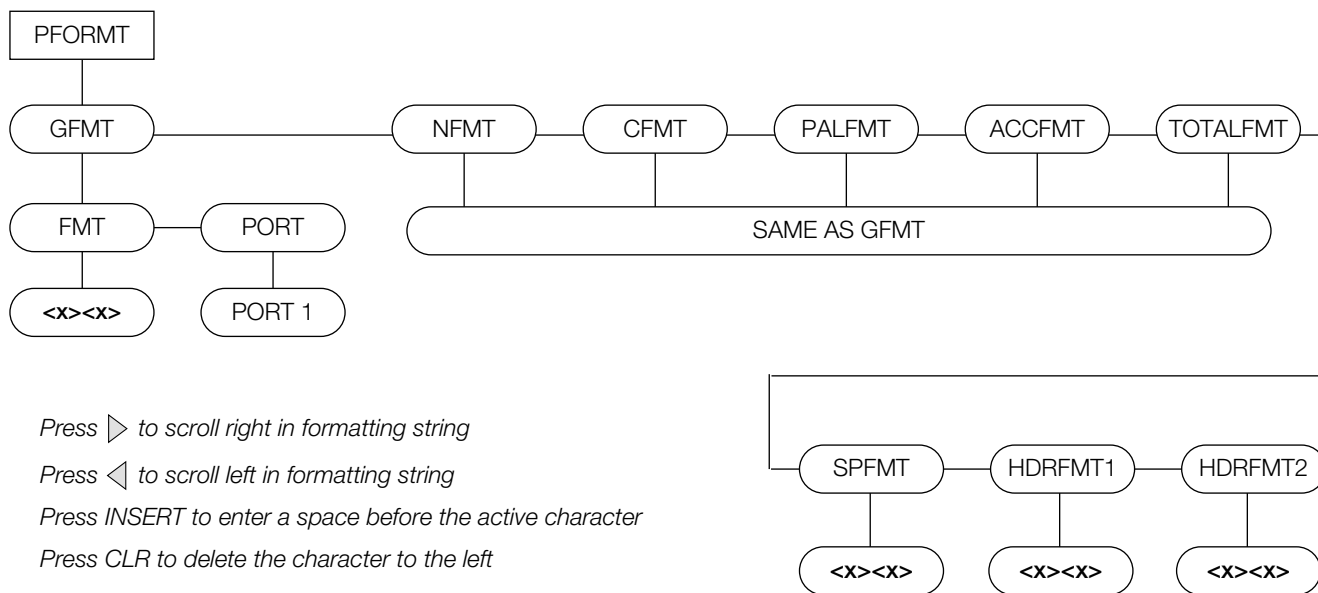

Press  to scroll right in formatting string

Press  to scroll left in formatting string

Press *INSERT* to enter a space before the active character

Press *CLR* to delete the character to the left

NOTE: To change the active character, use the alpha keypad to enter the new value.

Figure 7-1. *PFORMT* Menu, Showing Alphanumeric Character Entry Procedure

7.2.3 Using Revolution

The Revolution configuration utility provides a print formatting grid with a tool bar. The grid allows for the construction of the print format without the formatting commands (<NL> and <SP>) required by the front panel or EDP command methods. Using Revolution, type text directly into the grid, then select weight value fields from the tool bar and place them on desired area of printed ticket.

Figure 7-2 shows an example of the Revolution print formatting grid.

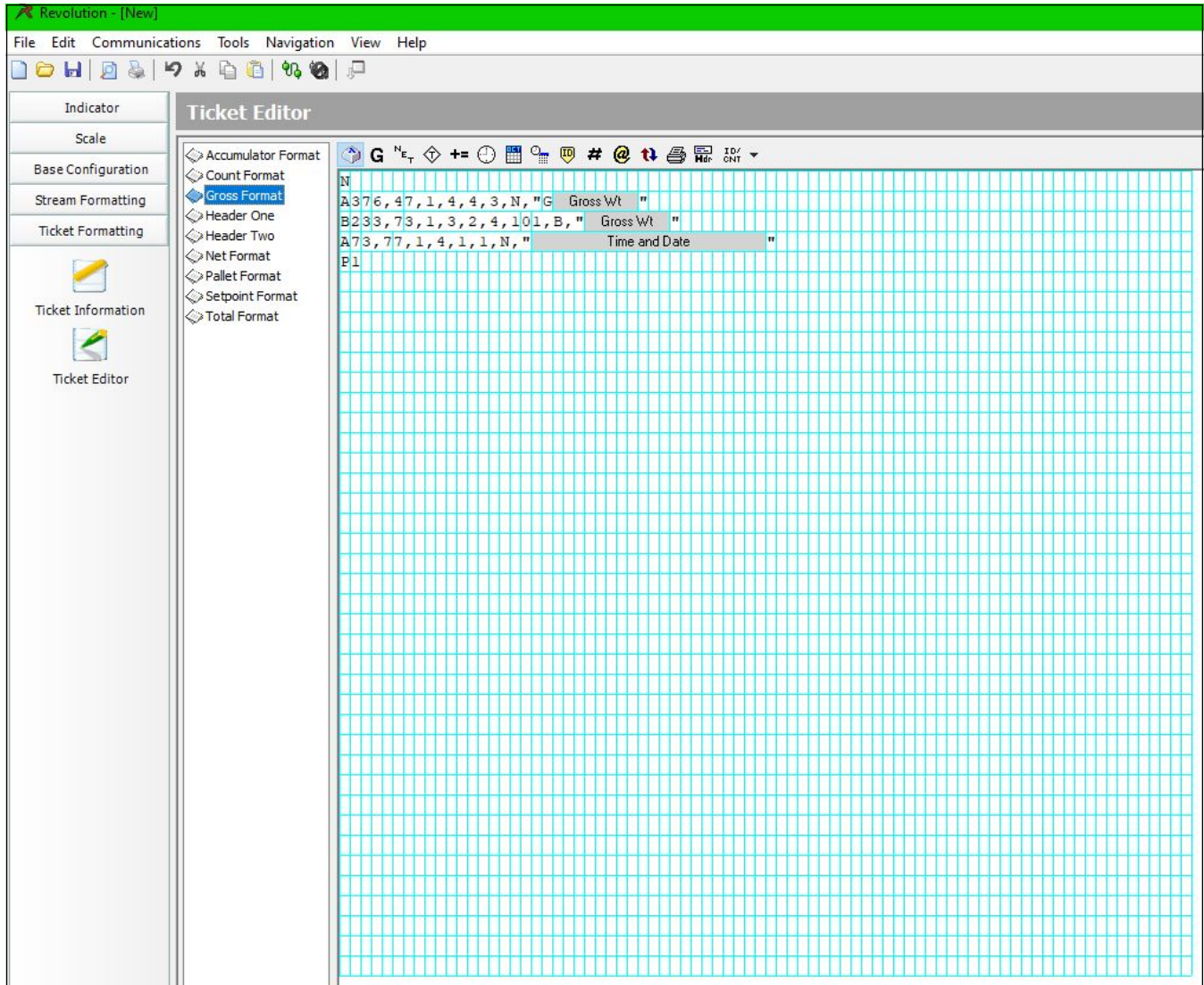

Figure 7-2. Revolution Print Format Grid

7.2.4 Print Label Examples

Listed below are print formatting examples (using the default formats) that appear with the various formats.

Count Format





ID. CODE: 1955	
	
QTY: 259234	GROSS 0.514 lb
	TARE 0.000 lb
WT/K OR U W	
0.001985	
	NET 0.514 lb
02:13PM 10/24/2012	

Figure 7-3. Count Format Label Example

Pallet Label Format



ID CODE: 1955

Total QTY: 259371

Part Name: SCREW
Part Number: 1955.1635879
Lot Number: 15A

Figure 7-4. Pallet Format Label Example

Gross Label Format

G	0.515 lb
	
0.515 lb	
02:14PM 10/24/2012	

Figure 7-5. Gross Label Format

Setpoint Format



Figure 7-6. Setpoint Label Format

Total Label Format

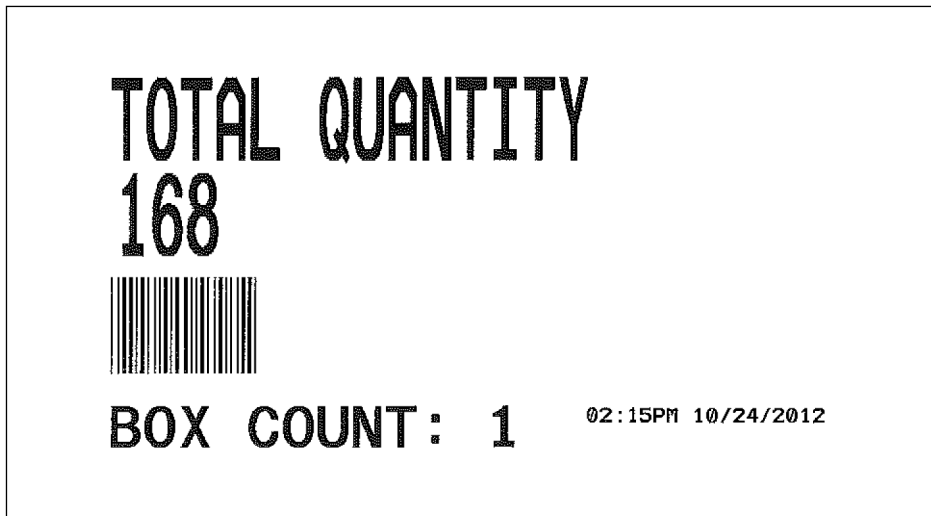

Figure 7-7. Total Format Label Example

Gross/Tare/Net Label Format

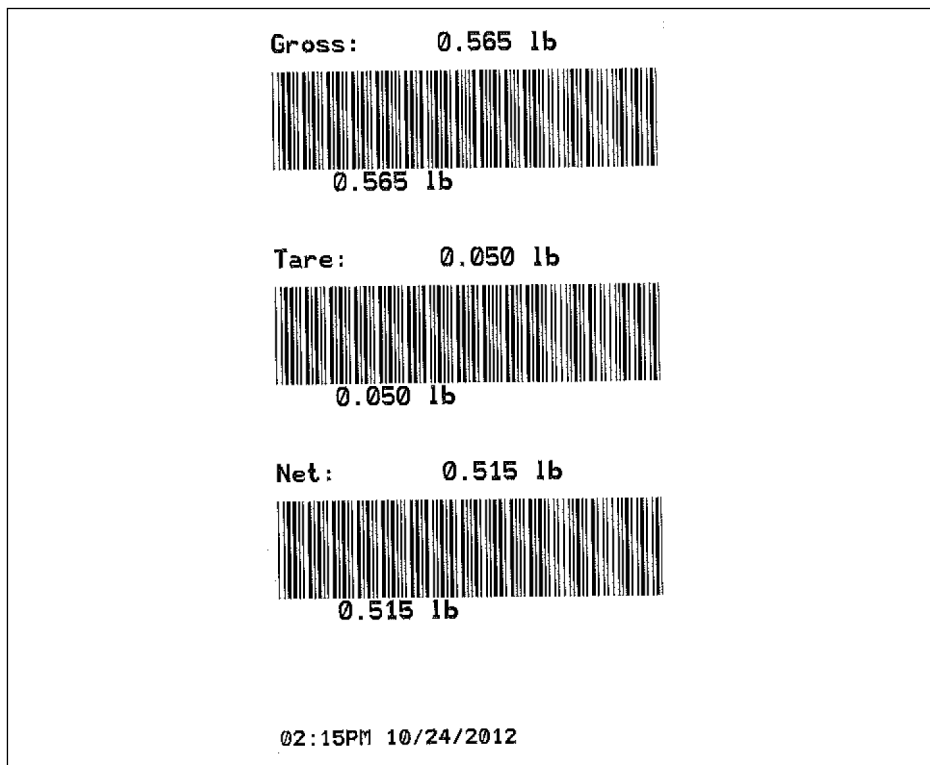

Figure 7-8. Gross/Tare/Net Label Format

Accum Label Format

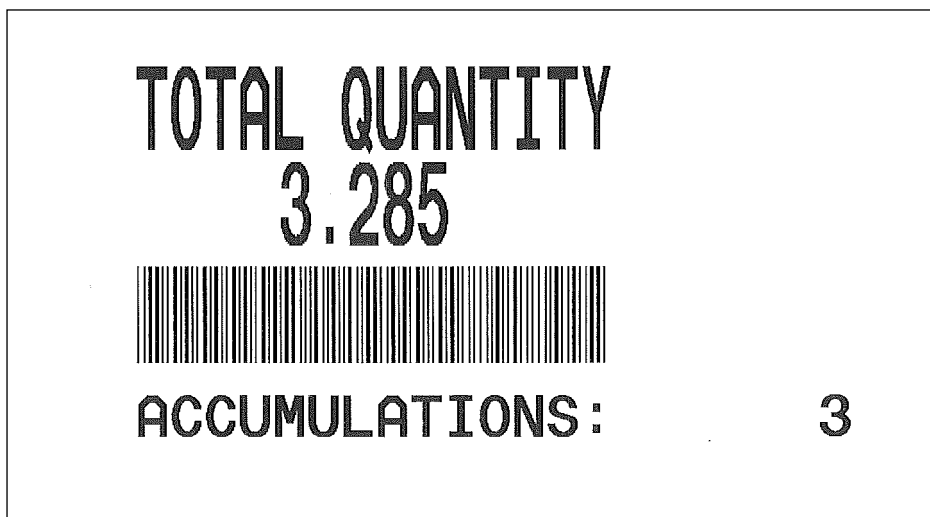

Figure 7-9. Accum Label Format

8.0 WLAN Installation Instructions



NOTE: Before installing this option, contact your IT administrator to obtain network communication protocol codes and have a RS-232 communications cable or regular comm port cable available to run between the PC and the indicator while installing and setting up the wireless network.

The optional Lantronix wireless networking device (PN 125495) can be installed inside the Counterpart for real-time data transmission to warehouse management systems. The Windows-based configuration software, DeviceInstaller™ is required for installation and is available from the manufacturer's website <https://www.lantronix.com>.

The wireless LAN option comes in a kit containing the following items:

- Wireless board (PN 205755)
- Antenna (PN 98357)
- Antenna coverplate (PN 121117)
- Standoffs (PN 95356)



NOTE: Wireless network kit 108671 has been superseded by 125495.

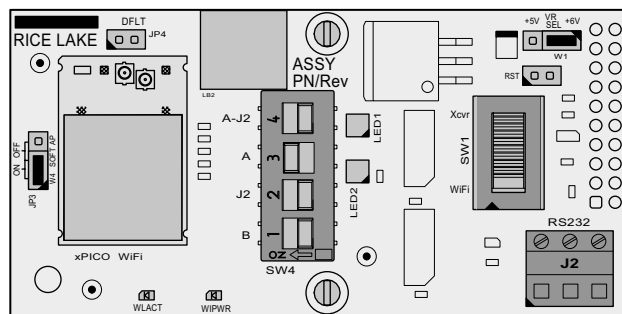

Figure 8-1. WLAN Board

8.1 Enclosure Disassembly

The indicator enclosure must be opened to install the WLAN option card and antenna and to connect cables for the installed option card.



CAUTION: Before opening the unit, be sure the power cord is disconnected from the power outlet.

1. Disconnect the indicator from its power source.
2. Remove four cover mounting screws from indicator.

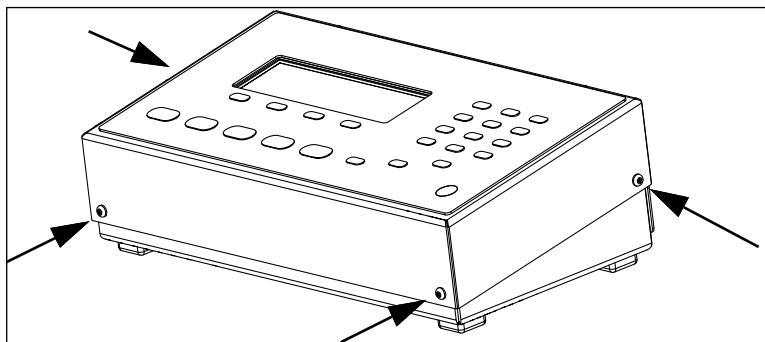

Figure 8-2. Counterpart Cover Mounting Screws

3. Remove the cover from the indicator and place upside down on anti-static mat.

8.2 WLAN Card Installation

Refer to WLAN Installation Instructions (PN 206460) included with the WLAN option card for installation and configuration instructions.

8.3 Antenna Installation with Cover Plate

1. Install antenna in new cover option plate with included washer and nut.

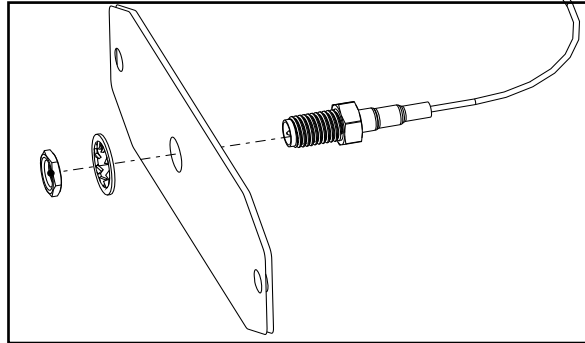

Figure 8-3. Installing Antenna Jack to Option Cover Plate

2. Remove two nuts and washers mounting the existing cover option plate to inside the cover.
3. Install cover option plate with antenna to cover using mounting hardware previously removed.

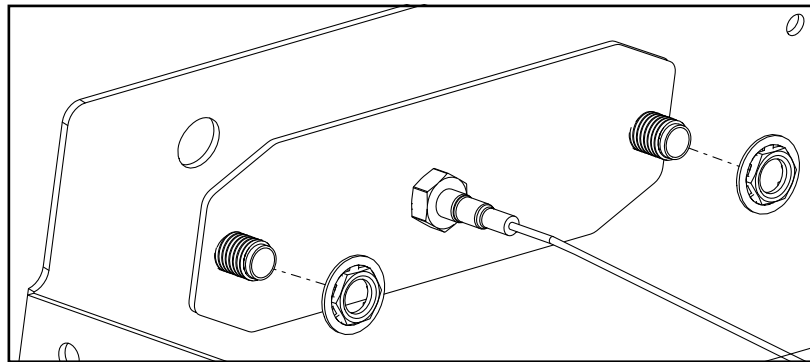

Figure 8-4. Installation Option Cover Plate with Antenna Jack to Cover

4. Thread the included antenna onto the end of the RF cable.
5. Connect the u-FI end of the antenna cable to the Antenna 1 connection on the WLAN card.

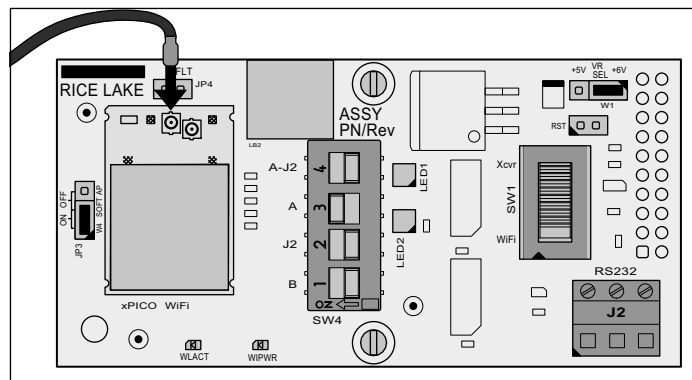

Figure 8-5. Antenna Connection Location

6. Reinstall Cover with four screws previously removed (Figure 8-2 on page 89).

8.4 Antenna Installation with Bushing

1. Carefully remove cutout.
2. Push bushing into cutout until it snaps into place.
3. Position antenna in bushing (included with Counterpart) where antenna pivot point protrudes into Counterpart.
4. Thread antenna into antenna jack.

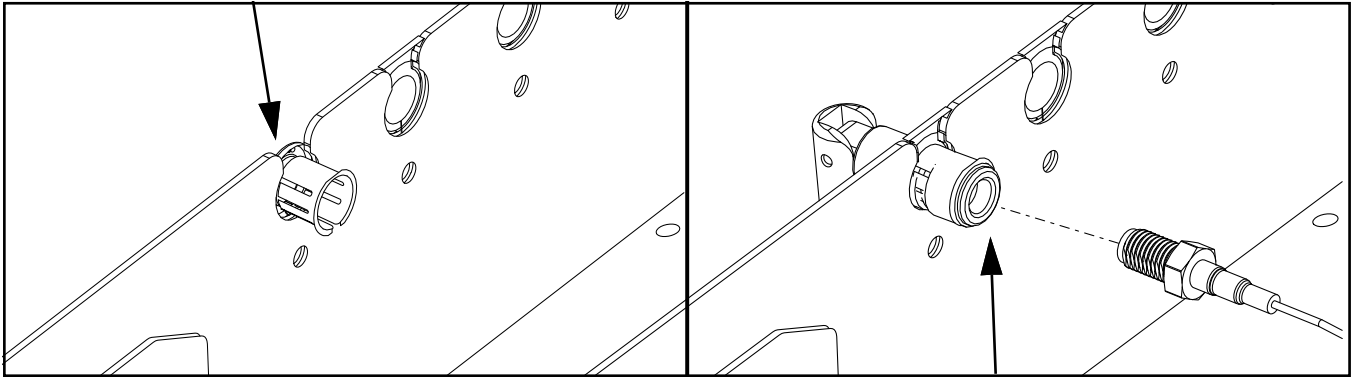

Figure 8-6. Install Antenna in Cover

5. Connect the u-FI end of the antenna cable to the Antenna 1 connection on the WLAN card.

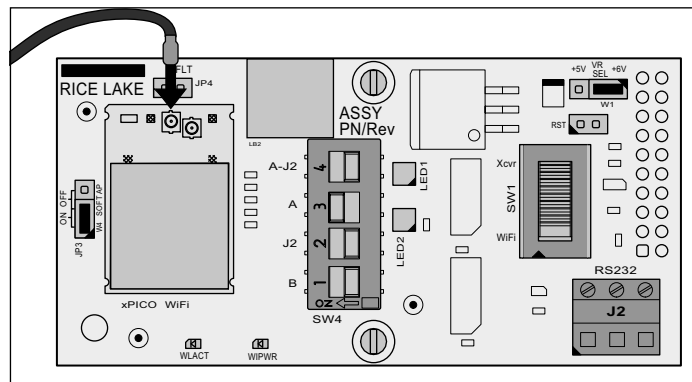

Figure 8-7. Antenna Connection Location

6. Reinstall Cover with four screws previously removed (Figure 8-2 on page 89).

9.0 Appendix

9.1 Error Messages

If an error code appears on the display, use the information in [Table 9-1](#) as a troubleshooting guide. If unable to clear the error, call RLWS Service for assistance.



Error Display	Description	Solution
	Over range	<ul style="list-style-type: none"> • Check load cell wiring, including sense jumpers • Check configuration, including number of grads, channel selection, display divisions • Check calibration, including W ZERO and WSPAN values • Under range can be caused by OIML setting and weight less than -20 display divisions • Check for scale binding or damage • Check for proper excitation voltage • Call Rice Lake Weighing Systems Service for assistance
	Under range	
	A/D out of range	
CHKERR - BATTERY BACK LOST	Battery Error	Press ENTER after replacing battery to restore defaults to battery backed storage
ERROR	Internal program error	Check configuration; Run XE command (Section 9.2 on page 93) to determine error type; Call Rice Lake Weighing Systems for service if unable to clear error by cycling power or if error reoccurs
HWFERR	Hardware error	Reboot the unit; Call Rice Lake Weighing Systems Service if unable to clear error by cycling power or if error reoccurs
INVALID UNITS	ID uses unassigned units	Modify the ID to use a configured unit
NOTARE	Tare is prevented	Change regulatory mode settings or the TAREFN parameter
OVERFL	Overflow error	Weight value too large to be displayed
OL	Overload error	Scale has been overloaded; Remove load from scale
RANGE	GRADS > 100,000 WVAL > 100,000	Only shows up in Config mode
EEPERR	EEPROM error	Call Rice Lake Weighing Systems for service
VERSION UPDATED	Core has been updated or memory has been corrupted	Press the ENTER key; If the message persists, call Rice Lake Weighing Systems for service.

Table 9-1. Counterpart Error Messages

9.2 Using the XE and XEH EDP Commands

The XE and XEH EDP commands can be used to remotely query the Counterpart for the error conditions shown on the front panel. The XE command returns a 5-digit number in the format:

xxxxx

where xxxxx contains a decimal representation of any existing error conditions as described in [Table 9-2](#).

The XEH command returns a value in the format:

0xxxxxxxx

where xxxxxxxx contains a hexadecimal representation of any existing conditions as described in [Table 9-2](#).

If more than one error condition exists, the number returned is the sum of the values representing the error conditions.

For example, if the XE command returns the number 1040, this value represents the sum of an A/D reference error (1024) and an A/D calibration checksum error (16).

XE Error Code (Decimal)	Description	XEH Error Code (Hexadecimal)
1	VIRGERR	0x00000001
2	PARMCHKERR	0x00000002
4	LOADCHKERR	0x00000004
8	PRINTCHKERR	0x00000008
16	ENVRAMERR	0x00000010
32	ENVCRCERR	0x00000020
64	BATTERYERR	0x00000040
32768	GRAVERR	0x00008000
65536	ADPHYSICALERR	0x00010000
131072	TAREERR	0x00020000
262144	EACCOVER	0x00040000
524288	STRINGERR	0x00080000
1048576	RESERVED_PF	0x00100000
2097152	RTCERR	0x00200000
4194304	MISSINGHWERR	0x00400000
8388608	CFGCONFLICTERR	0x00800000
16777216	UNRECOVERABLEERR	0x01000000
0x10000 - 0x80000000		Reserved

Table 9-2. Error Codes Returned on XE Command

9.2.1 Using the P EDP Command

The P EDP command returns the current displayed weight value to the EDP port.

9.3 Continuous Output (Stream) Format

[Figure 9-1](#) shows the default continuous output format sent to a Counterpart port when that port's STREAM parameter (SERIAL menu) is set to LFT.

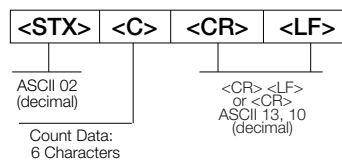

Figure 9-1. Continuous Output Data Format

9.4 Demand Output Data Format

When demand mode is configured for the communications port (STREAM parameter set to OFF), the Counterpart uses a data string formatted for a basic ticket printout. The particular ticket format printed depends on the indicator configuration.

The ticket can be customized to work with a wide variety of printers, scoreboard displays, and other remote equipment. See [Section 7.0 on page 81](#) for more information on custom print formats.

9.5 Custom Stream Formatting

Each port can be independently configured to stream a default frame format or can be customized to stream a user-defined format. Custom formatting is very similar to the standard print formatting described in [Section 7.0 on page 81](#).

[Table 9-3](#) lists the tokens used to configure a custom stream format.

Token	Defined By	Description
<P[G N T]>	STR.POS# <i>n</i> STR.NEG# <i>n</i>	Polarity; Specifies positive or negative polarity for the current or specified (Gross/Net/Tare) weight on source scale; Possible values are SPACE, NONE, + (for STR.POS), or – (for STR.NEG)
<CU>	STR.PRI# <i>n</i> STR.SEC# <i>n</i> STR.TER# <i>n</i>	Units; Specifies primary, secondary, or tertiary units for the current or specified weight on the source scale
<U[P S T]>	Dynamic	=L if Units = LB =K if Units = KG =G if Units = G =O if Units = OZ
<M[G N T]>	STR.GROSS# <i>n</i> STR.NET# <i>n</i> STR.TARE# <i>n</i>	Mode; Specifies gross, net, or tare weight for the current or specified weight on the source scale
<S>	STR.MOTION# <i>n</i> STR.RANGE# <i>n</i> STR.OK# <i>n</i> STR.INVALID# <i>n</i>	Status for the source scale; Default values and meanings for each status: STR.MOTION M In motion STR.RANGE O Out of range STR.OK <space> OK STR.INVALID I Invalid
<C>	–	Piece count for the currently viewed scale
<B [-]n,...>	See descriptions below	Bit fields; Comma-separated sequence of bit field specifiers; Must be exactly 8 bits; Minus sign (–) inverts the bit
B0	–	Always 0
B1	–	Always 1
B2	Configuration	=1 if even parity
B3	Dynamic	=1 if MODE=NET
B4	Dynamic	=1 if COZ
B5	Dynamic	=1 if standstill
B6	Dynamic	=1 if gross negative
B7	Dynamic	=1 if out of range
B8	Dynamic	=1 if secondary/tertiary
B9	Dynamic	=1 if tare in system
B10	Dynamic	=1 if tare is keyed
B11	Dynamic	=00 if MODE = GROSS =01 if MODE = NET =10 if MODE = TARE =11 (not used)
B12	Dynamic	=00 if UNITS = PRIMARY =01 if UNITS = SECONDARY =10 if UNITS = TERTIARY =11 (not used)
B13	Configuration	=00 (not used) =01 if current DSPDIV = 1 =10 if current DSPDIV = 2 =11 if current DSPDIV = 5

Table 9-3. Custom Stream Formatting Tokens

Token	Defined By	Description
B14	Configuration	=00 (not used) =01 if primary DSPDIV = 1 =10 if primary DSPDIV = 2 =11 if primary DSPDIV = 5
B15	Configuration	=00 (not used) =01 if secondary DSPDIV = 1 =10 if secondary DSPDIV = 2 =11 if secondary DSPDIV = 5
B16	Configuration	=00 (not used) =01 if tertiary DSPDIV = 1 =10 if tertiary DSPDIV = 2 =11 if tertiary DSPDIV = 5
B17	Configuration	=000 if current DECPNT = 8888800 =001 if current DECPNT = 8888880 =010 if current DECPNT = 8888888 =011 if current DECPNT = 888888.8 =100 if current DECPNT = 88888.88 =101 if current DECPNT = 8888.888 =110 if current DECPNT = 888.8888 =111 if current DECPNT = 88.88888
B18	Configuration	=000 if primary DECPNT = 8888800 =001 if primary DECPNT = 8888880 =010 if primary DECPNT = 8888888 =011 if primary DECPNT = 888888.8 =100 if primary DECPNT = 88888.88 =101 if primary DECPNT = 8888.888 =110 if primary DECPNT = 888.8888 =111 if primary DECPNT = 88.88888
B19	Configuration	=000 if secondary DECPNT = 8888800 =001 if secondary DECPNT = 8888880 =010 if secondary DECPNT = 8888888 =011 if secondary DECPNT = 888888.8 =100 if secondary DECPNT = 88888.88 =101 if secondary DECPNT = 8888.888 =110 if secondary DECPNT = 888.8888 =111 if secondary DECPNT = 88.88888
B20	Configuration	=000 if tertiary DECPNT = 8888800 =001 if tertiary DECPNT = 8888880 =010 if tertiary DECPNT = 8888888 =011 if tertiary DECPNT = 888888.8 =100 if tertiary DECPNT = 88888.88 =101 if tertiary DECPNT = 8888.888 =110 if tertiary DECPNT = 888.8888 =111 if tertiary DECPNT = 88.88888
<wspec [-] [0] digit[.][digit]>	Scale weight	Weight for the source scale. wspec is defined as follows: wspec Indicates whether the weight is the current displayed weight (W, w), gross (G, g), net (N, n), or tare (T, t) weight; Upper-case letters specify right-justified weights; Lower-case are left-justified; Optional /P, /S, or /T suffixes can be added before the ending delimiter (>) to specify weight display in primary (/P), secondary (/S), or tertiary (/T) units; [-] Enter a minus sign (-) to include sign for negative values; [0] Enter a zero (0) to display leading zeros. digit[.][digit] The first digit indicates the field width in characters; Decimal point only indicates floating decimal; Decimal point with following digit indicates fixed decimal with n digits to the right of the decimal; Two consecutive decimals send the decimal point even if it falls at the end of the transmitted weight field
<CR>	-	Carriage return
<LF>	-	Line feed

Table 9-3. Custom Stream Formatting Tokens (Continued)

9.6 Digital Filtering

The Counterpart uses averaged digital filtering to reduce the effect of vibration on weight readings. Adjustable threshold and sensitivity functions allow quick settling by suspending filter averaging, allowing the weight reading to jump to the new value. [Figure 9-2](#) shows the digital filter parameters on the CONFIG menu.

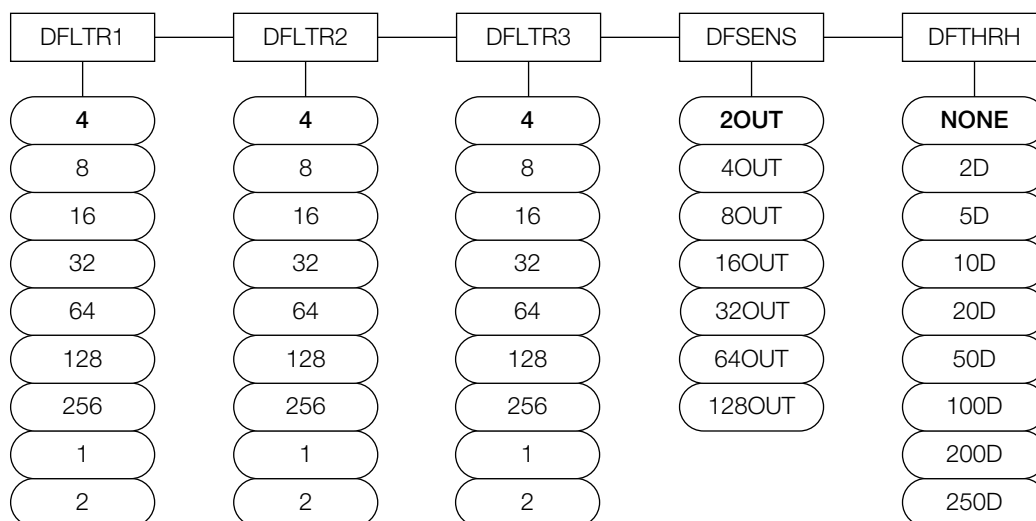

Figure 9-2. Digital Filtering Parameters on the Configuration (CONFIG) Menu

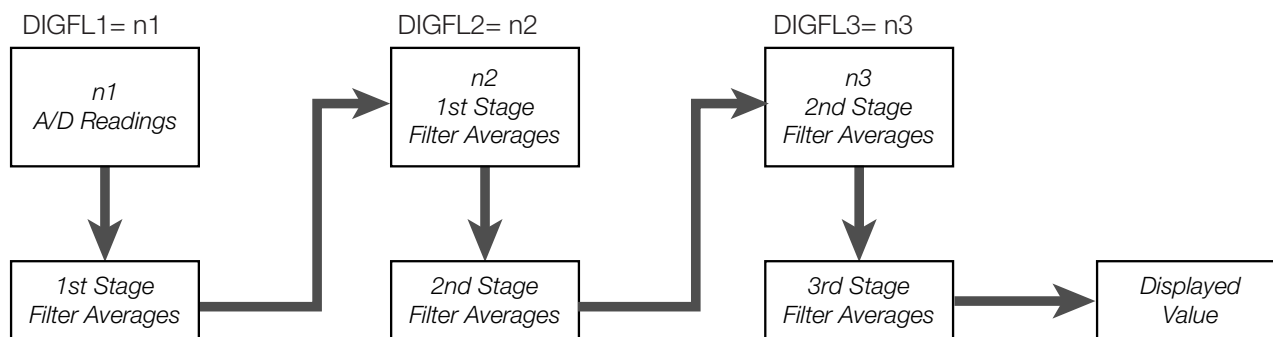

Figure 9-3. Flow Diagram for Counterpart Digital Filters

9.6.1 DIGFLx Parameters

The first three digital filtering parameters, DFLTR1, DFLTR2, and DFLTR3, are configurable filter stages that control the effect of a single A/D reading on the displayed weight. The value assigned to each parameter sets the number of readings received from the preceding filter stage before averaging ([Figure 9-3](#)).

The overall filtering effect can be expressed by adding the values assigned to the three filter stages:

$$\text{DFLTR1} + \text{DFLTR2} + \text{DFLTR3}$$

For example, if the filters are configured as DFLTR1=4, DFLTR2=8, DFLTR3=8, the overall filtering effect is 20 (4 + 8 + 8).

With this configuration, each A/D reading has a 1-in-20 effect on the displayed weight value. Setting the filters to 1 effectively disables digital filtering.

9.6.2 DFSENS and DFTHR Parameters

The three digital filters can be used by themselves to eliminate vibration effects, but heavy filtering also increases settling time. The DFSENS (digital filter sensitivity) and DFTHR (digital filter threshold) parameters can be used to temporarily override filter averaging and improve settling time:

- DFSENS specifies the number of consecutive scale readings that must fall outside the filter threshold (DFTHR) before digital filtering is suspended
- DFTHR sets a threshold value, in display divisions; When a specified number of consecutive scale readings (DFSENS) fall outside of this threshold, digital filtering is suspended; Set DFTHR to NONE to turn off the filter override

9.6.3 Setting the Digital Filter Parameters

Fine-tuning the digital filter parameters greatly improves indicator performance in heavy-vibration environments. Use the following procedure to determine vibration effects on the scale and optimize the digital filtering configuration.

1. In menu mode, set all three digital filters (DFLTR1, DFLTRL2, DFLTR3) to 1. Set DFTHRH to NONE. Return indicator to normal mode.
2. Remove all weight from the scale, then watch the indicator display to determine the magnitude of vibration effects on the scale. Record the weight below which all but a few readings fall. This value is used to calculate the DFTHRH parameter value in [Step 4](#).

For example, if a heavy-capacity scale produces vibration-related readings of up to 50 lb, with occasional spikes to 75 lb, record 50 lb as the threshold weight value.

3. Place the indicator in menu mode and set the digital filters (DFLTR x) to eliminate the vibration effects on the scale. (Leave DFTHRH set to NONE.) Reconfigure as necessary to find the lowest effective values for the DFLTR x parameters.
4. With optimum values assigned to the DFLTR x parameters, calculate the DFTHRH parameter value by converting the weight value recorded in [Step 2](#) to display divisions:

$$\text{threshold_weight_value} / \text{DSPDIV}$$

In the example in [Step 2](#), with a threshold weight value of 50 lb and a display division value of 5 lb:
 $50 / 5\text{lb} = 10\text{DD}$. DFTHRH should be set to 10DD for this example.

5. Finally, set the DFSENS parameter high enough to ignore transient peaks. Longer transients (typically caused by lower vibration frequencies) will cause more consecutive out-of-band readings, so DFSENS should be set higher to counter low frequency transients.

Reconfigure as necessary to find the lowest effective value for the DFSENS parameter.

9.6.4 Audit Trail Support

Audit trail support provides tracking information for configuration and calibration events. To prevent potential misuse, all configuration and calibration changes are counted as change events.

Use the Audit menu or Revolution to display audit trail information. This includes the legally relevant (LR) version number (software version for the code that provides audit trail information), a calibration count and a configuration count.

Audit trail information can be printed from Revolution or by sending the DUMPAUDIT EDP command.

9.7 USB Keyboard Interface

The USB interface option board provides a type-A connection for a USB keyboard interface. To use the keyboard interface, set the serial input function for Port 3 (found under the SERIAL menu — see [Figure 3-21 on page 54](#)) to KEYBOARD.

[Table 9-4](#) summarizes the Counterpart specific functions provided by the keyboard interface, most other alphanumeric and navigational keys provide functions equivalent to those typical for PC operation. Menu parameters and EDP commands that affect the indicator keypad operation (including KBDLCK, ZERONLY, and KLOCK EDP commands) also affect the remote keyboard.

Key	Function
F1	Softkey 1
F2	Softkey 2
F3	Softkey 3
F4	Softkey 4
F5	Unit Weight key
F6 (Alt + z)	ZERO key
F7 (Alt + g)	GROSS/NET key
F8 (Alt + t)	TARE key
F9 (Alt + u)	UNITS key
F10 (Alt + p)	PRINT key
F11	SAMPLE key
F12	MENU key
Print Screen	PRINT key

Table 9-4. USB Keyboard Functions



NOTE: *The keyboard interface is hot-pluggable.

***Caps lock is functional (off at indicator power up).**

***Num lock is on and cannot be turned off.**

***Scroll lock is not supported.**

***Other USB devices are not supported.**

9.8 Serial Scale Interface

Serial port 1 can be configured for serial scale input. The serial scale function allows other scale indicators to send gross, or net weight data to Counterpart. Once the serial port has been configured to accept scale data, the data format can be customized to match the data stream sent by that indicator. See [Figure 3-21 on page 54](#) for setup information.

To set up and configure a serial scale:

1. Under the SERIAL menu, select Port 1 and scroll over to IND SC (industrial serial scale) or SCALE (Legal-for-Trade), depending on what is required. This enables Scale 3. For operation with the counting functions, set type to IND SC.
2. Match the baud rates (9600), data bits and parity, and stop bits. This becomes SCALE 3.
3. Set the format under the SFMT parameter to match the format sent by the serial scale.

Example of the default serial scale format is: <STX><P><W7><U><M><S><CR>



NOTE: Counterpart serial scale input can accept and display 1 million display divisions.

Where:

<STX> STX character
 <P> Polarity
 <W7> Seven characters of net data with decimal pt
 <U> Units
 <M> Mode
 <S> Status
 <CR> Carriage return







NOTE: Industrial serial scales (IND SC) do not require the <M>, <U> and <S> identifiers. However, the units and number of decimal places must be specified. Units can be selected from the FORMAT menu; decimal places should be indicated with a w-spec identifier.

Example: A seven-digit weight reading with two decimal places should be specified as <W7.2> rather than <W7>.

To change or match formats, use the same path to change formats.

9.9 Regulatory Mode Functions

The function of the front panel  and  depend on the value specified for the REGULAT parameter on the FEATURE menu. Table 9-5 describes the function of these keys for the NTEP, CANADA, OIML, and NONE regulatory modes.

 and  functions are configurable when the REGULAT mode is set to INDUST (Table 9-6).

REGULAT Parameter Value	Weight on Scale	Tare in System	Front Panel Key Function	
			TARE	ZERO
NTEP	Zero or negative	No	No action	ZERO
		Yes	CLEAR TARE	
	Positive	No	TARE	
		Yes	TARE	
CANADA	Zero or negative	No	No action	ZERO
		Yes	CLEAR TARE	
	Positive	No	TARE	
		Yes	No action	
OIML	Zero or negative (not to exceed -20dd)	No	No action	ZERO
		Yes	CLEAR TARE	ZERO and CLEAR TARE
	Positive	No	TARE	ZERO
		Yes	TARE	ZERO and CLEAR TARE if weight is within ZRANGE; No action if weight is outside of ZRANGE
NONE	Zero or negative	No	TARE	ZERO
		Yes	CLEAR TARE	
	Positive	No	TARE	
		Yes	CLEAR TARE	

Table 9-5. TARE and ZERO Key Functions for REGULAT Parameter Settings

Table 9-6 lists the subparameters available when configuring a scale using INDUST mode. The table includes the default values of the INDUST subparameters and the effective (not configurable) values used by the NTEP, CANADA, OIML, and NONE regulatory modes.

REGULAT / INDUST Parameter		REGULAT Mode				
Parameter Name	Text Prompt	INDUST	NTEP	CANADA	OIML	NONE
SNPSHOT	Display or Scale weight source	DISPLAY	DISPLAY	DISPLAY	DISPLAY	SCALE
ZTARE	Remove tare on ZERO	NO	NO	NO	YES	NO
KTARE	Always allow keyed tare	YES	YES	NO	YES	YES
MTARE	Multiple tare action	REPLACE	REPLACE	NOTHING	REPLACE	REMOVE
NTARE	Allow negative tare	NO	NO	NO	NO	YES
CTARE	Allow CLEAR key to clear tare/accumulator	YES	YES	NO	NO	YES
PRTMOT	Allow print while in motion	NO	NO	NO	NO	YES
PRTPT	Add PT to keyed tare print	NO	NO	YES	YES	NO
OVRBASE	Zero base for overload calculation	CALIB ZERO	CALIB ZERO	CALIB ZERO	SCALE ZERO	CALIB ZERO

Table 9-6. REGULAT / INDUST Mode Parameters, Comparison with Effective Values of Other Modes

9.10 Regulatory Mode and Legal-for-Trade (LFT)



NOTE: When **REGULAT** is set for **NONE** or **INDUST** there are no restrictions on displaying both weight and piece count data.

If the unit is going to be used in Legal for Trade applications, weight and piece count data cannot be displayed at the same time. Use the following examples to use Counterpart in Legal for Trade applications.

9.10.1 Legal for Trade and Normal Weight Mode

When in a Legal for Trade mode (**REGULAT** = **NTEP**, **OIML**, or **CANADA**) and the unit is in normal weigh mode:

- If the weight displays in the main area (either as a result of the **DSPMODE** parameter being set for **WEIGHT** or the Swap Display softkey was pressed) then the piece count and unit weight are not displayed

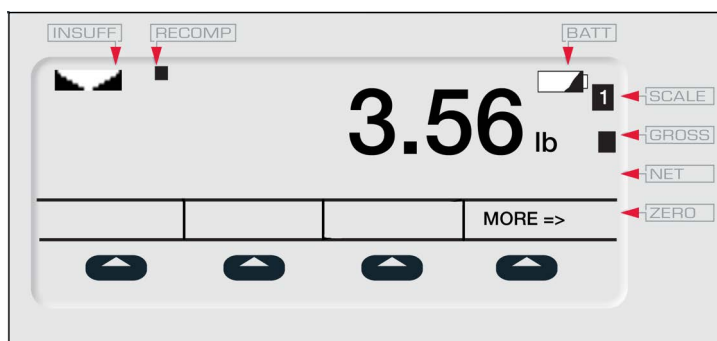

Figure 9-4. Piece Count and Unit Weight Not Displayed

- If the piece count displays in the main area (either as a result of the **DSPMODE** parameter being set for **COUNT** or the Swap Display softkey was pressed) then the weight is not displayed; The unit weight will be displayed in the left display area

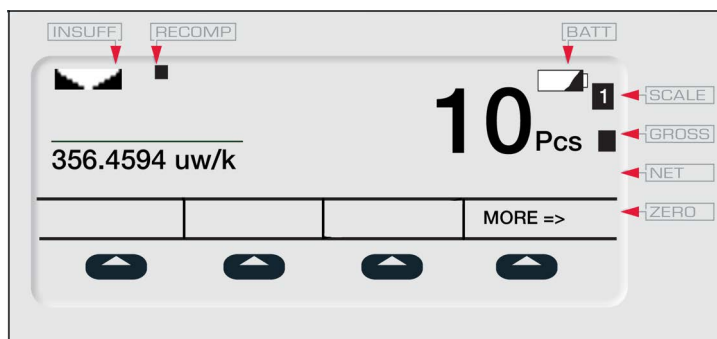

Figure 9-5. Unit Weight Displayed in Left Display Area

- If the unit weight displays in the main area (either as a result of the **DSPMODE** parameter being set for **UNITWEIGHT** or the Swap Display softkey was pressed) then the weight is not displayed; The piece count will be displayed in the left display area

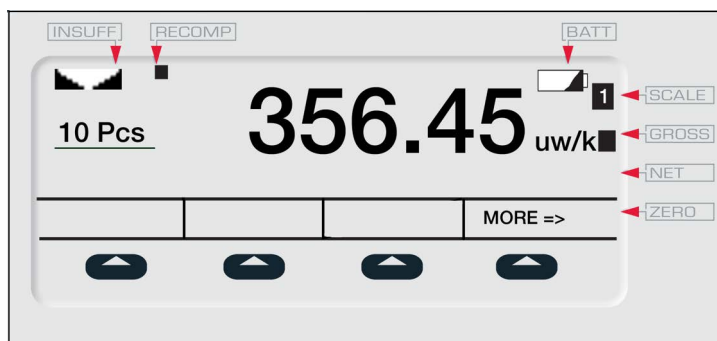

Figure 9-6. Piece Count Displayed in Left Display Area

9.10.2 Legal for Trade and Totalization Mode

When in Legal for Trade mode (REGULAT = NTEP, OIML, or CANADA) and the unit is in Totalization mode:

- If the weight displays in the main area (either as a result of the DSPMODE parameter being set for WEIGHT or the Swap Display softkey was pressed) then the piece count and piece count total are not displayed

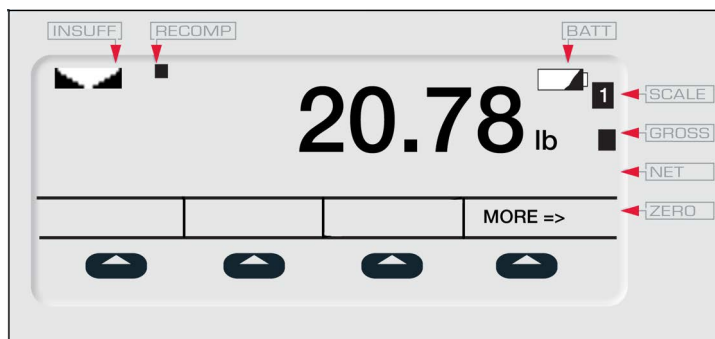

Figure 9-7. Piece Count and Piece Count Total Not Displayed

- If the piece count displays in the main area (either as a result of the DSPMODE parameter being set for COUNT or the Swap Display softkey was pressed) then the weight is not displayed; The piece count total will be displayed in the left display area

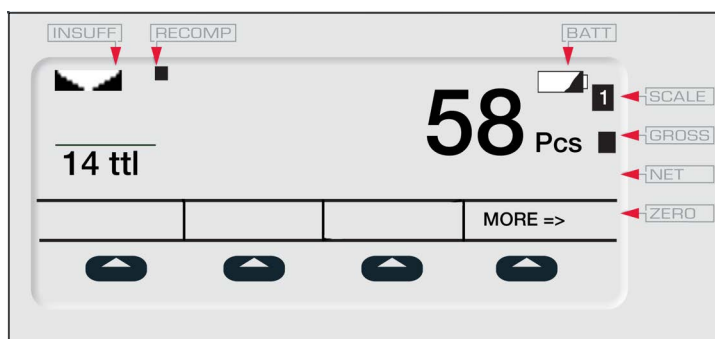

Figure 9-8. Piece Count Total Displayed in Left Display Area

- If the piece count total displays in the main area (either as a result of the DSPMODE parameter being set for UNITWEIGHT or the Swap Display softkey was pressed) then the weight is not displayed; The piece count will be displayed in the left display area

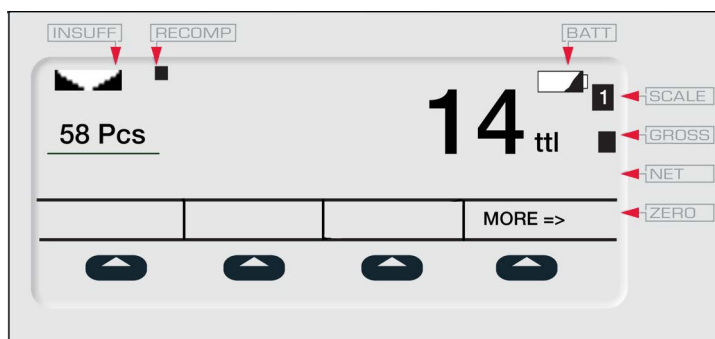

Figure 9-9. Piece Count Displayed in Left Display Area

9.11 Updating Firmware

To update firmware of the Counterpart, Revolution must be installed and a .hex file on your computer.

Visit <H65>www.ricelake.com to download this free configuration software and the latest .hex file.



NOTE: If the hex file is the same version as is currently in the indicator, the firmware update will not reset the configuration. This is helpful if the firmware becomes corrupt and you want to reload the same firmware. However, it is always recommended that configuration be backed up in Revolution to avoid any data loss.

1. Unplug power to the Counterpart and remove top from the base of the unit.
2. Wire the serial cable to the Counterpart's Port 1. Refer to [Table 9-7](#) for cable connection settings.

DB9 Cable				Connector (J5)		
Pin/Color	Signal	In/Out	Description	Pin	Description	In/Out
1/Brown	DCD	In	Data carrier detect	NC	NA	NA
2/Red	RxD	In	Receive data	3	Tx	Out
3/Orange	TxD	Out	Transmit data	4	Rx	In
4/Yellow	DTR	Out	Data terminal ready	5	DTR	In
5/Green	GND	-----	Ground	1 or 2	Gnd	
6/Blue	DSR	In	Data set ready	NC	NA	NA
7/Purple	RTS	Out	Request to send	6	RTS	In
8/Gray	CTS	In	Clear to send	NC	NA	NA
9/Black	RI	In	Ring indicator	NC	NA	NA

Table 9-7. Cable Connection Settings

3. Install jumpers on JP5 and JP6 ([Table 2-9 on page 22](#)).
4. Plug in power to the Counterpart and press the indicator's **Power** button.
5. With Revolution open, begin a new configuration file for the Counterpart. Click **Update Counterpart Firmware**.

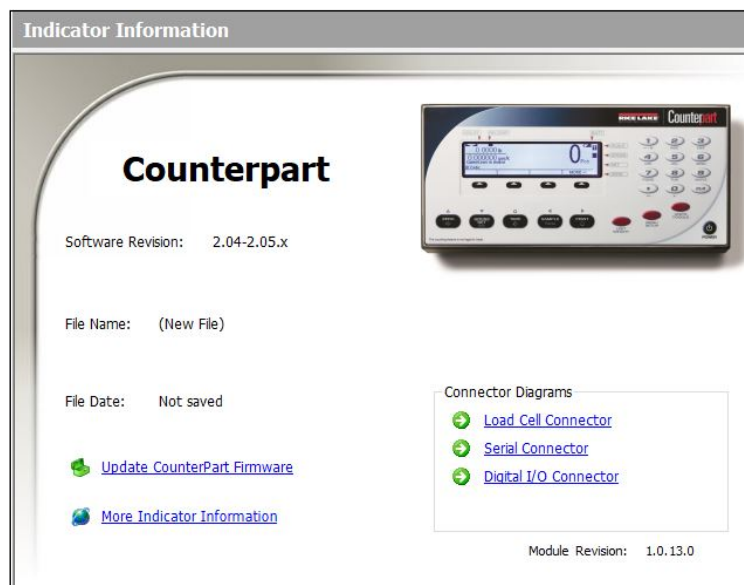

Figure 9-10. Revolution Display

- The Rice Lake Updater display appears. Specify the COM port the Counterpart is connected to, and click the ellipses (...) to browse to and select the desired .hex file.

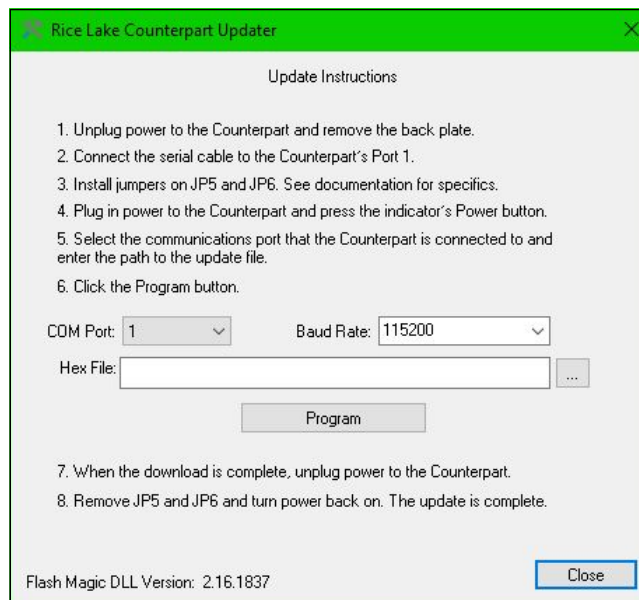

Figure 9-11. Rice Lake Updater Display

- Click the **Program** button. The update will take several moments.
- When complete, remove the jumpers shown in [Figure 2-14 on page 21](#) and press the **Power** button to power up the indicator.

9.12 Resolutions and Dimensions

Part No.	Description	Weighing Resolution	Platter Dimensions
Single Channel			
118788	CP Indicator	Console only	
120736	CP-5	5 lb x 0.0005 lb (2 kg x 0.0002 kg)	9" x 12"
120737	CP-10	10 lb x 0.001 lb (5 kg x 0.0005 kg)	11" x 16"
120738	CP-25	25 lb x 0.002 lb (10 kg x 0.001 kg)	11" x 16"
120739	CP-50	50 lb x 0.005 lb (20 kg x 0.002 kg)	11" x 16"
120740	CP-100	100 lb x 0.01 lb (50 kg x 0.005 kg)	11" x 16"
Dual Channel (Single Platform XL Base Systems)			
120770	CP dual indicator	Console only	
119796	CP-5	5 lb x 0.0005 lb (2 kg x 0.0002 kg)	9" x 12"
118797	CP-10	10 lb x 0.001 lb (5 kg x 0.0005 kg)	11" x 16"
118798	CP-25	25 lb x 0.002 lb (10 kg x 0.001 kg)	11" x 16"
118799	CP-50	50 lb x 0.005 lb (20 kg x 0.002 kg)	11" x 16"
118800	CP-100	100 lb x 0.01 lb (50 kg x 0.005 kg)	11" x 16"
Dual Channel With Benchmark			
125113	CP-50BM	50 lb x 0.01 lb (20 kg x 0.002 kg)	12" x 18"
125116	CP-100BM	100 lb x 0.02 lb (50 kg x 0.005 kg)	12" x 18"

Table 9-8. Resolutions and Dimensions

10.0 Specifications

Power Source:

Input: 100 to 240 VAC, 47-63 Hz, 5 watts, U.S. power cord
Output: 9 to 12 V, 1.5 A max

Excitation Voltage:

5 VDC

Analog Signal Input Range:

0 to 4.5 mV/V

Analog Specifications:

Grad minimum: 3 μ V/grad
Input sensitivity: 1.5 μ V/grad recommended
Zero adjustment range: 0-100% or per region settings
A/D conversion rate: 7.5, 15, 30 samples per second
Load cells per scale: 8 x 350 Ω ; 16 x 700 Ω
Scale channels: 1 or 2
Linearity: \pm 0.017 full scale

Circuit Protection:

RFI, EMI, ESD protection

Digital I/O:

Four

Display:

Viewing area: 240 x 64 pixels, transmissive VGA liquid crystal display (LCD) with adjustable contrast

Keypad:

24 buttons, full keypad (alpha numeric)

Resolution:

Internal: 1,000,000 counts
Display: up to 100,000 graduations

Communications and Setpoint

Two RS-232 ports support up to 115,200 bps
20 mA
Ethernet port
Setpoint output

Annunciators:

PCS, motion, low battery, insuff, recomp, scale number, gross, net, zero

Units of Measure:

Pounds, kilograms, grams, ounces

Prints:

Standard EPL label format; format is changeable to work with virtually any printer

Battery (Optional):

Type: Lithium-ion
Charge time: 6 to 8 hours
Charge cycles: 400 to 1,200
Estimated runtime: 24 to 32 hours with one 350 Ω load cell base

Temperature:

Operating: 32°F to 104°F (0°C to 40°C)

Operating Humidity:

85%

Physical Dimensions:

(L x W x H) Indicator only
12.25 x 6.25 x 4.0 in (311.15 x 158.75 x 101.6 mm)

Warranty:

Two-year limited warranty

Approvals



NTEP

CoC Number: 12-110
Accuracy Class: III / IIIIL; n_{max} : 5000



Measurement Canada

Approval Number: AM-5918C
Accuracy Class: III / IIIIHD; n_{max} : 5000



UL Listed

File Number: US-19009-UL





© Rice Lake Weighing Systems Contents subject to change without notice.

230 W. Coleman St. • Rice Lake, WI 54868 • USA
U.S. 800-472-6703 • Canada/Mexico 800-321-6703 • International 715-234-9171 • Europe +31 (0)26 472 1319